HERE'S WHAT OTHERS SAY ABOUT THIS EXCITING BOOK

Walt Brown's book is the rarest of species: It is the most complete reference work I have encountered on the scientific aspects of the multifaceted subject of origins. At the same time it presents a comprehensive theoretical framework (his hydroplate theory) for reconciling the many seemingly unrelated, and sometimes apparently contradictory, facts that bear on these questions. This book is essential for any teacher or student who is serious about resolving these issues on the basis of the evidences rather than on opinions or unsubstantiated or unverifiable hypotheses.

Dr. C. Stuart Patterson, former Academic Dean and Professor of Chemistry, Emeritus, Furman University

The subject of origins is not peripheral; it is foundational. I have spent most of my adult career in universities in the U.S. and Europe (as a Fulbright scholar), and it is clear that Christianity is losing ground on college campuses. The Christian faith is becoming unraveled with bad science. I can say without reservation that *In the Beginning* is the single most useful resource I know of on this subject, bar none. Walt is both diligent and creative, and you will find the arguments concise and thought provoking. The material is helpful on almost any level, and the references will be invaluable to those wishing to dig deeper. If I had to send my child off with only two books, they would be the Bible and *In the Beginning*.

Dr. Kent Davey, Senior Research Scientist, The Center for Electromechanics, University of Texas at Austin

In the Beginning is a great creation-science book for teens and adults. It's easy to read, carefully researched, meticulously documented, and offers answers to the most important questions of the origins controversy. Besides the usual creation-science approach to questions about the historicity of Genesis and what happened to make the dinosaurs extinct, the book is unique in explaining for the first time how twenty-five major Earth features—including mountains, volcanoes, the Grand Canyon, and ice ages—resulted from a worldwide flood. At the same time, it reveals serious yet little-known problems with many evolutionist ideas about Earth history and the origin of life—including many ideas that evolutionists themselves have discarded, but are still taught as fact in children's textbooks. You owe it to yourself to get this book.

Mary Pride's Big Book of Home Learning, Science Reviews

Classic uniformitarian geology has failed to solve a number of problems in geology. By contrast, using catastrophic basic assumptions, Dr. Brown has given scientists a way of addressing many problems that is philosophically sound and scientifically acceptable to objective thinkers. Never before have I encountered a more intellectually satisfying and respectable attack on a broad spectrum of geologic and biologic problems that are laid bare in this work.

Dr. Douglas A. Block, Geology Professor, Emeritus, Rock Valley College

Dr. Walt Brown uses three striking gifts in his creation science research and teaching: (1) a highly organized mind, (2) the ability to consider scientific evidence without the encumbrance of conventional paradigms, and (3) the ability to articulate the material with complete clarity. Walt is a born teacher. This enables him to develop significant new theories, such as the hydroplate theory, and to present them with remarkable clarity in both his seminars and this book. I am convinced that everyone needs to be familiar with the landmark work documented in this book.

Dr. Stanley A. Mumma, Professor of Architectural Engineering, Pennsylvania State University

I know on the basis of conversations with high school and college students that Walt Brown's excellent book deals with issues they have to face. I gave one of my copies to a teenager who is fascinated by science. His mother called to tell me she is having trouble getting him to turn out the light at night. He is devouring it.

Donald Cole, Radio Pastor, Moody Broadcasting Network, Chicago, Illinois

The CSC classic, *In the Beginning*, provides perhaps the most useful analysis ever written on the subject of theistic evolution.

Dr. D. James Kennedy, author and former Senior Pastor, Coral Ridge Presbyterian Church, Fort Lauderdale

Of the many sources that exist to strengthen the Christian's position for creation, I believe that Walt Brown's is one of the clearest presentations available. The material in this book is not nebulous. On the contrary, it is precise. Walt has a knack for making what would, otherwise, be a complex subject into one easy to grasp. I wholeheartedly recommend this book.

Skip Heitzig, Senior Pastor, Calvary of Albuquerque

Books uncovering the false claims of evolutionists have become so numerous that well-prepared summaries are greatly needed, especially for introductory and classroom purposes. Admirably designed to meet this need is Walt Brown's *In the Beginning*. For me, the most spectacular section is its unfolding of the hydroplate theory in connection with the great universal flood. Brown's presentation is an astonishing explanation of where the water may have come from and where it went. It does forcefully replace the water-canopy theory, which has obvious problems connected with it.

Msgr. John F. McCarthy, J.C.D., S.T.D., Editor, *Living Tradition*, Rome, Italy

Dr. Walt Brown's seminal text, *In the Beginning: Compelling Evidence for Creation and the Flood* has developed into a mature exposition of an important new approach to the geological sciences. The hydroplate theory is an alternate explanation of events of the Noahic flood, present-day geological features of the world, and actual mechanisms that operated then and continue to do so now. It directly challenges the current plate tectonics model of large-scale geology, and suggests a major revamping of the geological events associated with the flood God sent upon the world in light of the clear text of Genesis. It represents, then, a serious attempt at reconstructing the science of geology from the ground up.

Martin G. Selbrede, "Reconstructing Geology: Dr. Walt Brown's Hydroplate Theory," *Chalcedon Report*

The subject of origins is inherently interesting to all of us, yet this topic is so broad that one can get lost in the sheer volume of information. As a biologist and a Christian, I find *In the Beginning: Compelling Evidence for Creation and the Flood* to be the most concise, scholarly treatment of the scientific evidence supporting creation that I have ever read. This book is a must for anyone who is serious about understanding the creation/evolution debate. Science teachers, regardless of religious affinities, should also find this excellent resource a valuable addition to their reference libraries.

Terrence R. Mondy, Outstanding Biology Teacher for Illinois, 1999–2000

Dr. Brown is delightfully straightforward about science and creation. His analysis is both thoughtful and faithful. Every informed Christian should have access to this insightful material.

Dr. Stu Weber, author of *Tender Warrior*, Senior Pastor, Good Shepherd Community Church, Boring, Oregon

The way to refute evolution: Don't bother. Let Dr. Walt Brown do it. Actually, anyone can vaporize the lies of the evolutionists with this most impressive layman's guide to scientific creation. If you have ever wondered how to reconcile the truths of Genesis with the rigors of the scientific method, then stop scratching your post-Neanderthal skull and see it explained fully. You will find that Dr. Brown has rooted out perplexing mysteries that most knowledgeable scientists are afraid to address. His book is loaded with irrefutably logical arguments.

Brother John Mary, M.I.C.M., Saint Benedict Center, Richmond, New Hampshire

Dr. Walt Brown is eminently qualified to write a book such as this. Just check his credentials. He carefully presents the facts in a manner that even I, who had trouble with science in school, can understand. I would particularly call your attention to the chapter on theistic evolution. Dr. Brown destroys that comfortable ground so many Bible believers love to stand on. This book should be in the hands of every truth-seeking student in the world.

Larry Wright, Bible teacher, founder of Abundant Life, Inc., Phoenix, Arizona

Let me recommend for your reading *In the Beginning*. As I observe the latent indifference to the preciousness of life, I see the results of our exposure to the evolution dogma. To believe we are a result of a random process removes all sense of moral consciousness and spiritual motivation. The research of Dr. Walt Brown is crucial, not just to academic discussion, but to the survival of our culture.

Dr. Darryl DelHousaye, author of *Today for Eternity*, President of Phoenix Seminary, Phoenix, Arizona

In the Beginning

Compelling Evidence for Creation and the Flood

Walt Brown, Ph.D.

For my grandchildren and a great grandchild, each a
delight, each a blessing:

Jared, Noelle, and Zakai

Seth and Haley

Luke and Kayla

Adam

Andrew

Alaina

Levi

Isaac

Sadie

Sean and Jenny

Ryan

Laney

Trent

Lily

Katha

Preston and Cassidy

Faith

Gunnar

Benji

and for those to come

Book cover and design: Bradley W. Anderson

Front Cover Illustration: NASA

Back Cover Illustration: Steve Daniels

Unless otherwise noted, all Scripture quotations are from the *New American Standard Bible*, © The Lockman Foundation, 1960, 1962, 1963, 1968, 1971, 1972, 1975, 1977, 1995. Used by permission.

In the Beginning: Compelling Evidence for Creation and the Flood

1st edition, 1980

9th edition, © 2019 by Walt Brown. All rights reserved.

Mission Imperative, Inc.

423 Orchid Circle

Lebanon, PA 17046

www.missionimperative.org

Library of Congress Cataloging-in-Publication Data has been applied for.

ISBN 978-0-692-17764-8

Printed in China

Preface

You may have several questions about this book: Why was it written? How is it organized and why? For whom is it intended? Where is the creation-evolution issue headed?

This study began unexpectedly in June 1970. I was a Christian, an evolutionist, and a new professor at the U.S. Air Force Academy. I heard surprising claims on the radio that Noah's Ark rested near the 14,000-foot level of Mount Ararat in eastern Turkey. If a gigantic boat had ever been at that elevation, a huge flood must have occurred. However, the biblical flood was always hard for me to imagine. After all, where could so much water come from? Where did it all go? Every attempt I had heard to answer the first question was shallow at best. Few, if any, ever tried to answer the second.

For two years I pondered these issues, reading most of what was written about claimed Ark sightings and talking with many "Ark hunters." Almost daily I gazed up at 14,000-foot Rocky Mountain peaks and tried to imagine, at one of their summits, an object large enough to fill a football stadium. The case for the Ark's existence grew stronger as many of my questions were answered.

With this growing possibility came a problem. If that much water sloshed over Earth for a year, many dead animals and plants would have been buried in vast amounts of mud and other sediments. This would explain how almost all fossils formed, especially those on the highest mountains. But the fossil record was supposedly the best evidence for evolution, a theory I had passively accepted. If a global flood produced most fossils, where was the evidence for evolution? The more I struggled with this question, the more amazed I became at the lack of evidence supporting evolution and the abundant evidence supporting creation and a global flood. By 1972, I had become a creationist.

As I began to talk with friends and colleagues about origins, invitations to speak arose. Speaking publicly on the subject forced me to organize my thoughts. In this way, the first edition of this book began to "evolve."

In 1978, my wife and I decided the subject was so broad and important that I should pursue it full time, and, therefore, leave a demanding, interesting, and successful military career at the first opportunity. That occurred in 1980. Since then, I have kept busy with study, writing, debates, speaking engagements, and research (particularly development of the *hydroplate theory*, which explains the flood) and answers many questions that scientists have had for centuries. It has been exciting to see how greater awareness of creation and the flood profoundly affects so many people. You may experience this yourself.

Initially, those attending the full-day "*In the Beginning*" Seminar were given material summarizing the seminar

content and answering many frequently asked questions. The first three editions of this book served that purpose. Later, outside requests for the book grew to the point that it had to be modified for those who were requesting the book but had not attended the seminars. However, the book's basic organization still follows the seminar format—an ideal format for learning this subject.

Part I of this book begins with a summary of the scientific evidence dealing with origins. That evidence falls into nine areas: three in the life sciences, three in the astronomical and physical sciences, and three in the Earth sciences. [Figure 1 on page x](#) shows this organization. Part II contains the most popular of those nine areas, as demonstrated in 200 full-day seminars and by letters, emails, and phone calls we receive daily. Scientists, in particular, are struck by the number and diversity of problems the hydroplate theory easily solves. Part III contains 46 questions most frequently asked during question-and-answer sessions at seminars and in media interviews—questions not already answered in Parts I and II.

This format and a comprehensive index, beginning on [page 612](#), allow readers to quickly find topics of interest, and see the broad scope of this subject. Parts I, II, and III, which are quite different, may be read independently and in any order. Difficult parts can be skipped. Readers are often amazed at the endnotes, which contain revealing and surprising quotations—usually from evolutionists.

The intended reader is anyone interested in the subject of origins—from high school students with little scientific background to people with multiple Ph.D.'s in science. Parents have even paraphrased topics for their children at mealtime or bedtime.

Here is an offer for students, parents, and educators who read the entire book. Rather than place you in the awkward position of debating with science teachers or professors who are evolutionists, let me suggest an interesting alternative. As you read this book, identify questions to ask educators. If they object to any scientific information or conclusion in the book, I will be happy to discuss it with them by telephone, provided you are part of our three-way conversation. With their permission, you may record our conversation for the entire class. If nothing else, this will sharpen everyone's critical thinking skills, put more information "on the table," and move us a little closer to the truth.

Where is the creation-evolution controversy headed? I believe the battle will be won—not in courts, legislatures, boards of education, or church councils—but by grass-roots science education. Yes, today evolutionists generally control higher education, science journals, and the media,

but the scientific evidence overwhelmingly supports creation and a global flood. (If you find someone who disagrees, please refer them to the preceding paragraph and the debate offers on pages 570–571. *Challenge them*—then watch what happens. You will probably hear some pitiful excuses.) Throughout the history of science, controversies have raged. Perhaps none have had the profound social consequences—and, therefore, the interest and emotion—of this origins debate. In the end, the side with the scientific evidence has always prevailed. The Galileo episode is one example.

Our task, then, is to educate the public, especially students. People who are aware of this evidence will inevitably bring pressure and embarrassment on entrenched interests, starting in the classroom. This is already happening. How can more be done? Many pictures in this book could be fascinating subjects for a grade-school child's classroom report. High school students could go further by reading and analyzing articles and reports related to such pictures. College students could extend this by interviewing and critiquing scientists specializing in the subject. Adults will

enjoy explaining these and hundreds of other points of evidence to friends. (Many conduct courses and give lectures using this book.) As more people learn, more will want to learn. Increasingly, the public will ask—or tell—educators, publishers, museums, and the media to educate themselves and stop perpetuating misinformation and bad science.

Although many people helped with this book and offered constructive suggestions, three should be mentioned. Brad Anderson's creativity and unparalleled expertise with computers and book design are seen on each page. Jon Schoenfield and Peggy Brown skillfully and meticulously checked and frequently improved all parts of the text. My family's support has been invaluable. To them and many others who helped, I am immensely grateful. The mistakes, of course, are mine alone.

My hope is that *In the Beginning: Compelling Evidence for Creation and the Flood* will help you, the reader, as you grasp the power and horror of the flood and explore the amazing events “in the beginning.”

Walt Brown

Any portion of this book may be reproduced for teaching or classroom use. For all other uses, simply reference this book and Walt Brown as your source. To publish figures not belonging to CSC, contact the owners listed in the Picture Credits beginning on page 610 for permission.

*The entire book is at: **www.creationscience.com**
The web version of the book is periodically updated.
There is no charge for reading or printing any or all portions of it.*

Those who have read the entire book and have questions about what Dr. Brown wrote may call 602-956-6880 on Fridays, between 3:00 and 5:00 P.M. (Phoenix, Arizona time). However, those who are teaching from this book and have related questions may call anytime.

Teachers may arrange—at no cost—for students who have read this book to question Dr. Brown by phone. Before the course begins, teachers should contact us, describe their class, and arrange for a mutually agreeable time to call near the end of the course. At the arranged hour, simply have a speakerphone in the classroom, so all students can participate.

Another way you may wish to be involved is described on page 565.

Table of Contents

Prefacev

Part I: The Scientific Case for Creation . . . 3

Life Sciences	7
Astronomical and Physical Sciences	29

Earth Sciences	46
--------------------------	----

Part II: Fountains of the Great Deep 110

The Hydroplate Theory: An Overview	113
The Origin of Ocean Trenches, Earthquakes, and the Ring of Fire	155
Liquefaction: The Origin of Strata and Layered Fossils	196
The Origin of the Grand Canyon	217

The Origin of Limestone	263
Frozen Mammoths	271
The Origin of Comets	305
The Origin of Asteroids, Meteoroids, and Trans-Neptunian Objects	342
The Origin of Earth's Radioactivity	384

Part III: Frequently Asked Questions 436

Why Are Creation and the Flood Important?	438
How Can the Study of Creation Be Scientific?	440
Why Is the Universe Expanding?	441
Galaxies Are Billions of Light-Years Away, So Isn't the Universe Billions of Years Old?	456
If the Sun and Stars Were Made on <i>Day 4</i> , What Was the Light of <i>Day 1</i> ?	461
How Old Do Evolutionists Say the Universe Is?	463
What Was <i>Archaeopteryx</i> ?	466
What Are the Predictions of the Hydroplate Theory?	469
What Triggered the Flood?	471
Did It Rain before the Flood? What Generated the Preflood Mist?	477
Have Parts of the Collapsed Subterranean Chamber Been Found?	484
Why did the Moon Roll—and When?	486
When Was the Flood, the Exodus, and Creation?	487
Did the Flood Last 40 Days and 40 Nights?	491
Could Earth's Mountain Ranges Form in Less Than an Hour?	493
Is the Hydroplate Theory Consistent with the Bible?	495
What about the Dinosaurs?	501
Why Is Global Warming Occurring? What Can Be Done about It?	503
Does Recently Declassified Data Falsify Plate Tectonic Theory?	509
Why Have So Few Human Fossils Been Found?	510
How Could Saltwater and Freshwater Fish Survive the Flood?	511
Why Did the Floodwater Drain So Slowly?	513
According to the Bible, When Was Adam Created?	515

How Accurate Is Radiocarbon Dating?	517
Why Did People Live for about 900 Years before the Flood?	521
Have Planets Been Discovered Outside the Solar System?	524
How Was the Earth Divided in Peleg's Day?	527
Did a Water Canopy Surround Earth and Contribute to the Flood?	530
Why Don't Creationists Publish in Leading Science Journals?	538
How Did Human "Races" Develop?	539
Is There a Large Gap of Time between Genesis 1:1 and 1:2?	540
Is There Life in Outer Space?	542
Have Scientific Tools Detected Adam and Eve within Us?	545
Is Evolution Compatible with the Bible?	549
What Questions Could I Ask Evolutionists?	557
How Can Origins Be Taught in High School or College?	559
What Are the Social Consequences of Belief in Evolution?	563
Does the New Testament Support Genesis 1–11?	565
How Can I Become Involved in This Issue?	568
Why Do Creation Organizations Have Differences?	569
How Harmful Is False Scientific Information?	577
How Do You Respond to Common Claims of Evolutionists?	578
How Do Evolutionists Respond to What You Say?	580
If God Made Everything, Who Made God?	581
What Is the Written Debate Offer?	582
What Is the Direct (Oral and Written) Refereed Exchange?	583

Technical Notes 584

Illustration Credits 622

Index **624**

The Scientific Evidence Is Consistent with Genesis

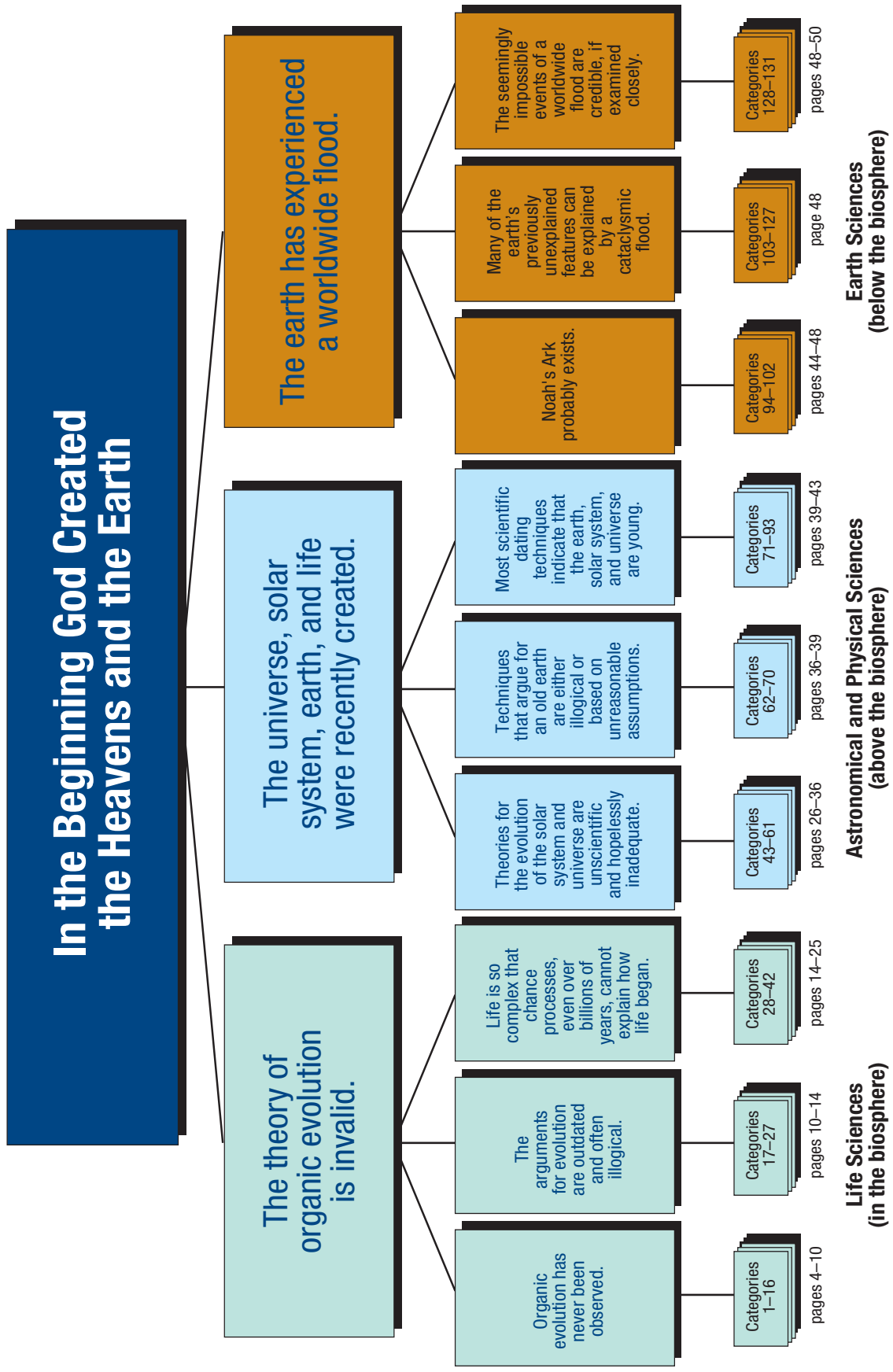

Figure 1: Organization of the Scientific Case for Creation.

Part I:

The Scientific Case for Creation

Part I is a brief summary, in outline form, of 131 categories of scientific evidence that support a sudden creation and oppose gradual evolution. As Figure 1 shows, categories 1–42 relate to the *life sciences*, 43–93 relate generally to the *astronomical and physical sciences*, and 94–131 relate to the *Earth sciences*.

Quotations, references, and notes on pages 51–107 provide supporting details for specific conclusions. Usually, these details are based on research done by evolutionists who are experts in a relevant field. Choosing evolutionists rather than creationists will minimize charges of bias. (Besides, no courtroom testimony is more convincing than that from a “hostile witness.”) Most people find the quotations, highlighted in blue type, fascinating.

For many years, students, teachers, and professors have been unaware of most of this information, especially the broader conclusions that can be reached. Those conclusions are stated in Figure 1 and in large, bold headings on the following pages. The larger the heading,

the broader the conclusion. There is one overall conclusion for the life sciences, one for the astronomical and physical sciences, and one for the Earth sciences. Each has three supporting conclusions, for a total of nine. A typical supporting conclusion is based upon about a dozen categories of evidence. All 131 are summarized on pages 5–50. Figure 1 shows the relationships of these 3 + 9 broad conclusions and the 131 categories of evidence.

Scientific information cannot be suppressed for long, so it is not surprising to see a growing awareness and excitement concerning this information. Some evidence involves new discoveries. Other evidence, discovered long ago, has been poorly disseminated. If all this information were openly presented in science classrooms, better education would result. Regardless of your age or education, you can learn and help others learn this information about a subject that holds great interest for most people—the subject of origins.

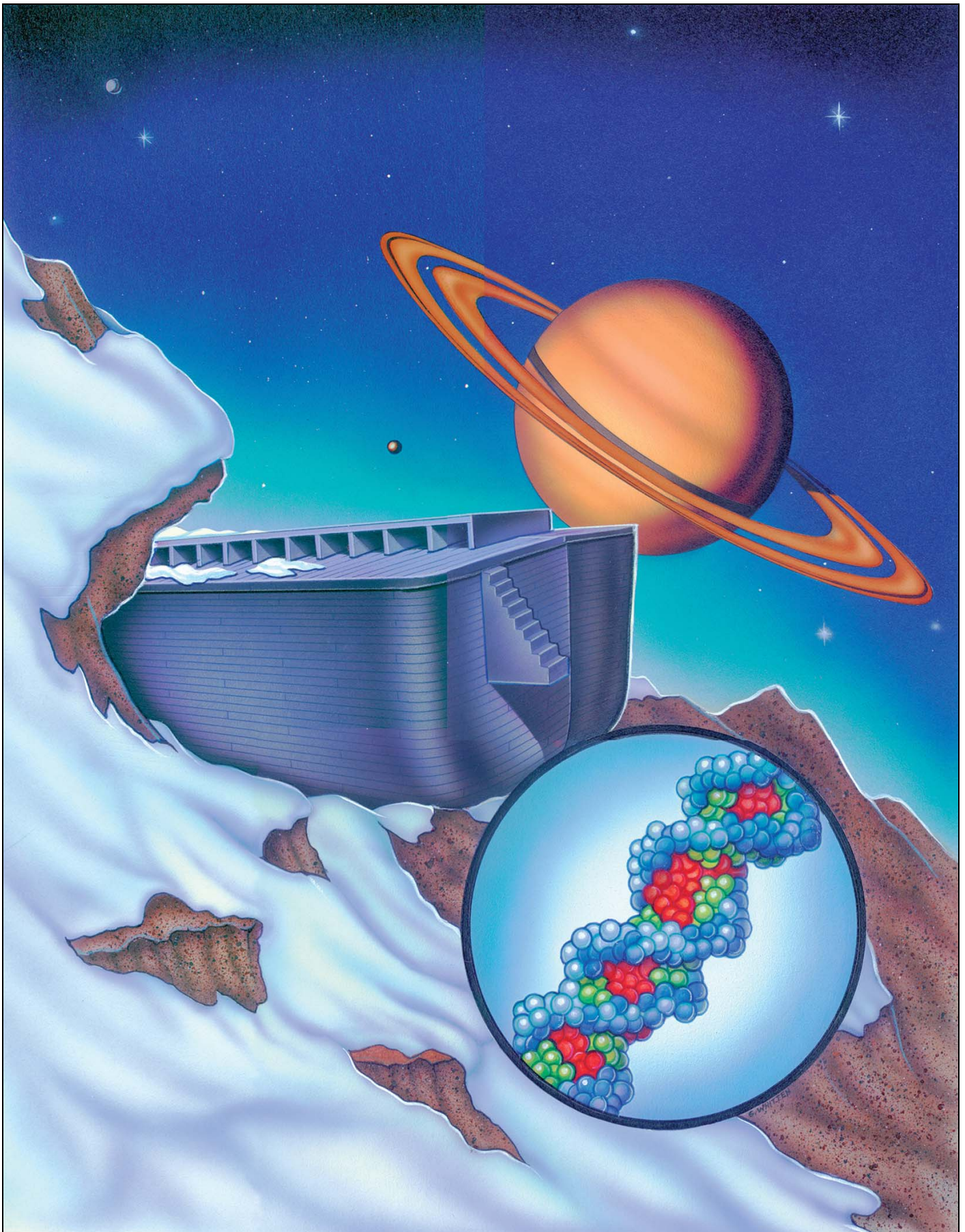

Figure 2: Depictions of Saturn, DNA, and the Ark.

Introduction

The scientific evidence showing the hand of the Creator falls into three major areas: life sciences, astronomical and physical sciences, and Earth sciences. Generally speaking, the life sciences involve the biosphere (the atmosphere, oceans, and other surface waters); astronomical sciences deal with phenomena above the biosphere; and Earth sciences deal with phenomena below the biosphere.

Three fascinating objects are depicted on the opposite page—one representing each of these three areas of science. Each involves new discoveries which excite both laymen and scientists. Each object is an amazing reminder of a designer whose attributes are too big, too complex, and too powerful for the mind of man to grasp.

Life Sciences

Shown in the circular inset near the bottom of [Figure 2](#) is the double helix representing DNA (deoxyribonucleic acid). Duplicate copies of this long tape of coded information are coiled up in almost all of the 30,000,000,000,000 (thirty trillion) cells in your body. The DNA in a human cell has 46 segments; you received 23 segments from your mother and 23 from your father. DNA contains the unique information that determines what you look like, much of your personality, and how every cell in your body is to function throughout your life.

If all the DNA in one of your cells were uncoiled, connected, and stretched out, it would be about 7 feet long. It would be so thin its details could not be seen, even under an electron microscope. If all this very densely coded information from *one cell* of one person were written in books, it would fill a library of about 4,000 books. If all the DNA *in your body* were placed end-to-end, it would stretch from here to the Moon more than 165,000 times! In book form, that information would fill the Grand Canyon almost 30 times. If one set of DNA (one cell's worth) from every person who ever lived were placed in a pile, the final pile would weigh less than an aspirin! Understanding DNA is just one small reason for believing that you are *"fearfully and wonderfully made."* (Ps 139:14) [See **"Genetic Information"** on [page 78](#) for the above calculations.]

Astronomical and Physical Sciences

Space exploration has brought into our living rooms some of the marvels of the universe. Few people appreciate how many of these recent discoveries were not what evolution theory had predicted. The phrase "back to the drawing board" often follows discoveries in space. Saturn, shown on the opposite page, has provided many such examples.

Early space exploration programs were attempts to learn how the Earth, Moon, and solar system evolved. Ironically,

not one of these questions has been answered, and for scientists who start with evolutionary assumptions, many perplexing problems have arisen. For example, after the \$20,000,000,000 lunar exploration program, no evolutionist can explain with any knowledge and confidence how the Moon formed. Those who try either encounter a barrage of scientific objections or resort to philosophical speculations. Isn't it ironic that so many science teachers and professors *uncritically* teach outdated and illogical theories in the very subject—science—that should encourage critical thinking? Far too many textbook authors and popular science commentators, who influence teachers and students alike, do not understand that *"the heavens are telling of the glory of God."* (Ps 19:1)

Earth Sciences

The center object on the opposite page represents Noah's Ark. This drawing is based on a detailed and convincing description by a man who claimed to have walked on the Ark twice in the early 1900s. His information has been checked in ways he could never have imagined. Every known detail has supported his story. We must emphasize, however, there is no proof the Ark exists, although there have been many alleged sightings. We must patiently wait for a verifiable discovery of this huge object.

The implications of a worldwide flood for the Earth sciences, for the theory of evolution, and for mankind generally, deserve the serious reflection of every thoughtful person. Earth has many features which scientists with evolutionary presuppositions cannot explain. But these features can be explained by a gigantic flood—the deadliest, most cataclysmic, and literally earthshaking event the world has ever experienced—which also formed deep ocean trenches, most mountains, and many other amazing features of Earth.

A detailed and scientific reconstruction of these events can now be made independently of Scripture. This reconstruction, based only on what is seen on Earth today, is explained in Part II, **"Fountains of the Great Deep,"** on pages 109–433. If you study both this explanation and biblical descriptions of the flood—two completely different perspectives—you may be startled by their agreement and the sheer power and violence of that event. Both biblical scholars and scientists have been surprised at how each perspective illuminates the other. After reading **"Fountains of the Great Deep,"** you will more deeply appreciate what the psalmist wrote 3,000 years ago: *"The waters were standing above the mountains. At Thy rebuke they fled; at the sound of Thy thunder they hurried away. The mountains rose; the valleys sank down ... [so the waters] may not return to cover the earth."* (Ps 104:6–9)



Figure 3: Dog Variability. When bred for certain traits, dogs become different and distinctive. This is a common example of microevolution—changes in size, shape, and color—or minor genetic alterations. It is not macroevolution: an upward, beneficial increase in complexity, as evolutionists claim happened billions of times between bacteria and man. Macroevolution has never been observed in any breeding experiment.

Life Sciences

Before considering how life began, we must first understand the term “organic evolution.” Organic evolution, as theorized, is a naturally occurring, beneficial change that produces increasing and inheritable complexity. Increased complexity would be shown if the offspring of one form of life had a different and improved set of vital organs. This is sometimes called the molecules-to-man theory—or *macroevolution*. [See Figure 4 on page 6.] Microevolution, on the other hand, does not involve increasing complexity. It involves changes only in size, shape, or color, or minor genetic alterations caused by one or more mutations. Each example of macroevolution would require thousands of “just right” mutations. Microevolution can be thought of as *horizontal* (or even downward) change, whereas macroevolution, if it were ever observed, would involve

an *upward*, beneficial change in complexity. Therefore, microevolution plus time will not produce macroevolution. (micro + time \neq macro)

Creationists and evolutionists agree that microevolution (and natural selection) occur. Minor change has been observed since history began. But notice how often evolutionists give evidence for microevolution to support macroevolution. It is macroevolution—which requires new abilities and increasing complexity, resulting from new genetic information—that is at the center of the creation-evolution controversy. Therefore, in this book, ***the term “organic evolution” will mean macroevolution.***

(Most readers will want to read the accompanying references, quotations, and notes beginning on [page 51](#).)

The Theory of Organic Evolution Is Invalid.

Organic Evolution Has Never Been Observed.

1. The Law of Biogenesis

Spontaneous generation (the emergence of life from nonliving matter) has never been observed. All observations have shown that life comes only from life. This has been observed so consistently it is called *the law of biogenesis*. The theory of evolution conflicts with this scientific law when claiming that life came from nonliving matter through natural processes.^a

Evolutionary scientists reluctantly accept the law of biogenesis.^b However, some say that future studies may show how life could come from lifeless matter, despite virtually impossible odds. Others are aware of just how complex life is and the many failed and foolish attempts to explain how

life came from nonlife. They duck the question by claiming that their theory of evolution doesn’t begin until the first life *somehow* arose. Still others say the first life was created, then evolution occurred. All evolutionists recognize that, based on scientific observations, *life comes only from life*.

2. Acquired Characteristics

Acquired characteristics—characteristics gained after birth—cannot be inherited.^a For example, large muscles acquired by a man in a weight-lifting program cannot be inherited by his child. Nor did giraffes get long necks because their ancestors stretched to reach high leaves. While almost all evolutionists agree that acquired characteristics cannot be inherited, many unconsciously slip into this false belief. On occasion, Charles Darwin did.^b

However, stressful environments for some animals and plants cause their offspring to express various defenses for the first time. New genetic traits are not acquired; instead, certain environments can switch on genetic machinery *already present*. Amazingly, this optimal^c genetic machinery already exists to handle some contingencies, opposing the belief that time, the environment, or “a need” can produce the machinery.^d

Also, rates of variation within a species (microevolution, not macroevolution) increase enormously when organisms are under stress, such as starvation.^e Stressful situations would have been widespread in the centuries after a global flood.

3. Mendel's Laws

Mendel's laws of genetics and their modern-day refinements explain almost all physical variations occurring within species. Mendel discovered that genes (units of heredity) are merely reshuffled from one generation to another. Different **combinations** are formed, not different genes. The different combinations produce many variations within each kind of life, as in the dog family. [See [Figure 3 on page 4.](#)] A logical consequence of Mendel's laws is that there are **limits** to such variation.^a Breeding experiments^b and common observations^c also confirm these boundaries.

4. Bounded Variations

Not only do Mendel's laws give a *theoretical* explanation for why variations are limited, broad *experimental* verification also exists.^a For example, if evolution happened, organisms (such as bacteria) that quickly produce the most offspring should have the most variations and mutations. Natural selection would then select the more favorable changes, allowing organisms with those traits to survive, reproduce, and pass on their beneficial genes. Therefore, organisms that have allegedly evolved the most should have short reproduction cycles and many offspring. We see the opposite. In general, more complex organisms, such as humans, have fewer offspring and longer reproduction cycles.^b Again, variations within organisms appear to be bounded.

Organisms that occupy the most diverse environments in the greatest numbers for the longest times should also, according to macroevolution, have the greatest potential for evolving new features and species. Microbes falsify this prediction as well. Their numbers per species are astronomical, and they are dispersed throughout almost all the world's environments. Even so, the number of microbial species is relatively few.^c New features apparently don't evolve.

5. Natural Selection

Like so many terms in science, the popular meaning of “natural selection” differs from what the words actually

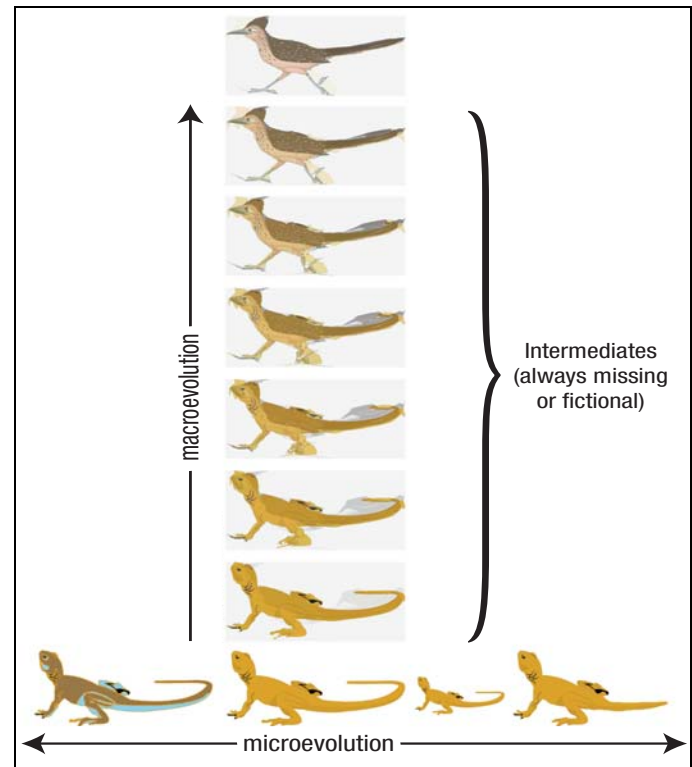

Figure 4: Microevolution vs. Macroevolution. Notice that macroevolution would require an upward change in the complexity of certain traits and organs. Microevolution involves only “horizontal” (or even downward) changes—no increasing complexity. Also note that all creationists agree that natural selection occurs. While natural selection does not result in macroevolution, it accounts for many variations within a very narrow range. Science must always base conclusions on what is seen and reproducible. So what is observed? We see variations in lizards, four of which are shown at the bottom. We also see birds, represented at the top. In-between forms (or intermediates), which should be vast in number if macroevolution occurred, are never seen as fossils or living species. A careful observer can usually see unbelievable discontinuities in these claimed upward changes, as well as in the drawing above.

Ever since Darwin, evolutionists have made excuses for why the world and our fossil museums are not overflowing with intermediates.

mean. “Selecting” implies something that nature cannot do: think, make decisions, or make choices. Instead, the complex genetics of each species allow variations within a species. In changing environments, those variations give some members of a species a slightly better chance to reproduce than other members, so their offspring have a better chance of surviving. The marvel is not about some capability that nature does not have, but about the designer who designed for adaptability and survivability in changing environments. With that understanding, the unfortunate term “natural selection” will be used.

An offspring of a plant or animal has characteristics that vary, often in subtle ways, from those of its “parents.” Because of the environment, genetics, and chance circumstances, some of these offspring will reproduce more than others. So, members of a species with certain

characteristics will tend, on average, to have more “children.” Only in this sense, does nature “select” genetic characteristics suited to an environment—and, more importantly, eliminates unsuitable genetic variations. Therefore, an organism’s gene pool is constantly decreasing.^a

Notice, natural selection cannot produce *new* genes; it “selects” only among preexisting characteristics. As the word “selection” implies, variations are reduced, not increased.^b

For example, many mistakenly believe that insect or bacterial resistances evolved in response to pesticides and antibiotics. Instead,

- ◆ a lost capability was reestablished, making it appear that something evolved,^c or
- ◆ a mutation reduced the ability of certain pesticides or antibiotics to bind to an organism’s proteins, or
- ◆ a mutation reduced the regulatory function or transport capacity of certain proteins, or
- ◆ a damaging bacterial mutation or variation reduced the antibiotic’s effectiveness even more,^d or
- ◆ a few resistant insects and bacteria were already present when the pesticides and antibiotics were first applied. When the vulnerable insects and bacteria were killed, resistant varieties had less competition and, therefore, proliferated.^e

While natural selection occurred, nothing evolved; in fact, some biological diversity was lost.

The variations Darwin observed among finches on different Galapagos Islands are another example of natural selection producing micro- (*not* macro-) evolution. While natural selection sometimes explains the survival of the fittest, it does not explain the *origin* of the fittest.^f Today, some people think that because natural selection occurs, evolution must be correct. Actually, natural selection *prevents* major evolutionary changes.^g It deletes information; it cannot create information.

6. Mutations

Mutations are the only known means by which new genetic material becomes available for possible evolution into new traits.^a Rarely, if ever, is a mutation beneficial to an organism in its natural environment. Almost all observable mutations are harmful; some are meaningless; many are lethal.^b No known mutation has ever produced a form of life having greater complexity and viability than its ancestors.^c

Dr. John Sanford has shown that mutations occur at such a rapid rate that “mutational meltdown” would have occurred if humans were only 100,000 years old. “Genetic entropy” is pushing mankind toward extinction.^d

7. Fruit Flies

A century of fruit fly experiments, involving 3,000 consecutive generations, gives absolutely no basis for believing

that any natural or artificial process can cause an increase in complexity and viability. No clear genetic improvement has ever been observed in any form of life, despite the many unnatural efforts to increase mutation rates.^a

8. Complex Molecules and Organs

Many molecules necessary for life, such as DNA, RNA, and proteins, are incredibly complex—so complex that claims they have evolved are absurd. Furthermore, those claims lack experimental support.^a

There is no reason to believe that mutations or any natural process could ever produce any new organs—especially those as complex as the eye,^b ear, or brain.^c For example, an adult human brain contains over 10^{14} (a hundred thousand billion) electrical connections,^d more than all the soldered electrical connections in the world. The human heart, a ten-ounce pump that can operate without maintenance or lubrication for about 75 years, is another engineering marvel.^e

9. Fully-Developed Organs

All species appear fully developed, not partly developed. They show design.^a There are no examples of half-developed feathers, eyes,^b skin, tubes (arteries, veins, intestines, etc.), or any vital organs (dozens in humans alone). Tubes that are not 100% complete are a liability; so are partially developed organs and some body parts. For example, if a leg of a reptile were to evolve into a wing of a bird, it would become a bad leg long before it became a good wing.^c [See Figure 4.]

10. Distinct Types



Figure 5: Duckbill Platypus. The duckbill platypus is found only in Tasmania and eastern Australia. European scientists who first studied platypus specimens thought that a clever taxidermist had stitched together parts of different animals—a logical conclusion if one believed that each animal must be very similar to other animals. In fact, the platypus is perfectly designed for its environment.

If evolution happened, one would expect to see gradual transitions among many living things. For example, variations of dogs might blend in with variations of cats.

In fact, some animals, such as the duckbill platypus, have organs totally unrelated to their alleged evolutionary ancestors. The platypus has fur, is warm-blooded, and suckles its young as do mammals. It lays leathery eggs, has a single ventral opening (for elimination, mating, and birth), and has claws and a shoulder girdle as most reptiles do. The platypus can detect electrical currents (AC and DC) as some fish can, and has a bill similar to that of a duck—a bird. It has webbed forefeet like those of an otter and a flat tail like that of a beaver. The male platypus can inject poisonous venom like a pit viper. Such “patchwork” animals and plants, called *mosaics*, have no logical place on the so-called “evolutionary tree.”

One study by evolutionists of the mitochondrial DNA of 100,000 animal species (including humans) found that neutral mutations (slight changes in DNA that neither help nor hurt an organism’s survival) show so little variation within each species that almost all of those species must have come into existence at about the same time—and recently. Furthermore, the gaps between species are huge. In other words, lots of time produces many slight variations within a species; time does not produce new species. (Darwin was also perplexed by the absence of in-between species.)^a

There is no direct evidence that any major group of animals or plants arose from any other major group.^b Species are observed only going out of existence (extinctions), never coming into existence.^c

11. Altruism

Humans and many animals will endanger or even sacrifice their lives to save another—sometimes the life of another species.^a Natural selection, which evolutionists say selects individual characteristics, should rapidly eliminate altruistic (self-sacrificing) “individuals.” How could such risky, costly behavior ever be inherited? Its possession tends to prevent the altruistic “individual” from passing on its genes for altruism?^b If evolution were correct, selfish behavior should have eliminated unselfish behavior.^c Furthermore, cheating and aggression should have “weeded out” cooperation. Altruism contradicts evolution.^d

12. Extraterrestrial Life?

No verified form of life which originated outside of Earth has ever been observed. If life evolved on Earth, one would expect that the elaborate experiments sent to the Moon and Mars might have detected at least simple forms of life (such as microbes) that differed in some respects from life on Earth.^a [See “**Is There Life in Outer Space?**” on page 531.]

13. Language

Language is unique to humans.^a Children as young as seven months can understand and learn grammatical

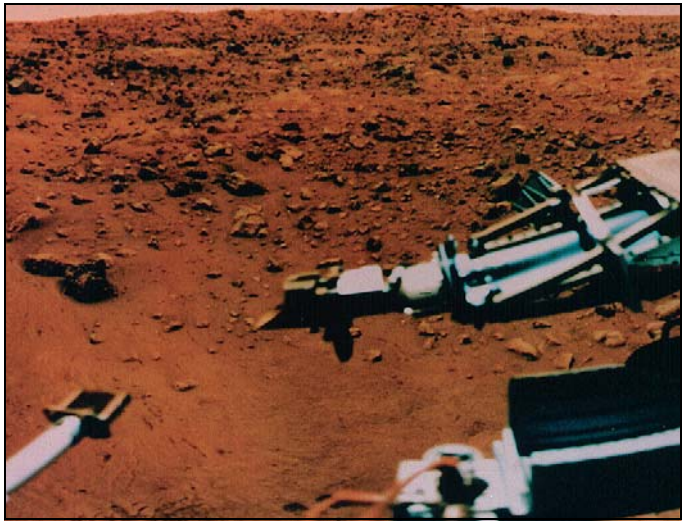

Figure 6: Mars Lander. Many people, including Carl Sagan, predicted the Viking landers would find life on Mars. They reasoned that because life evolved on Earth, some form of life must have evolved on Mars. That prediction proved to be false. The arms of the Viking 1 Lander, shown above, sampled Martian soil. Sophisticated tests on those samples did not find even a trace of life.

If traces of life are found on Mars, they may have come from comets and asteroids launched from Earth during the flood—as did salt and water found on Mars. [A prediction, later supported by a NASA discovery, is on page 314. For a full understanding, see pages 301–374.]

rules.^b Furthermore, studies of 36 documented cases of children raised without human contact (feral children) show that language is learned only from other humans; humans do not automatically speak. So, the first humans must have been endowed with a language ability. There is no evidence language evolved.^c

Nonhumans communicate, but not with language. True language requires both *vocabulary* and *grammar*. With great effort, human trainers have taught some gorillas and chimpanzees to recognize a few hundred spoken words, to point to up to 200 symbols, and to make limited hand signs. These impressive feats are sometimes exaggerated by editing the animals’ successes on film. (Some early demonstrations were flawed by the trainer’s hidden promptings.)^d

Wild apes have not shown these vocabulary skills, and trained apes do not pass their vocabulary on to others. When a trained animal dies, so does the trainer’s investment. Also, trained apes have essentially no grammatical ability. Only with grammar can a few words express many ideas. No known evidence shows that language exists or evolves in nonhumans, but all known human groups have language.^e

Furthermore, only humans have different modes of language: speaking/hearing, writing/reading, signing, touch (as with Braille), and tapping (as with Morse code or tap-codes used by prisoners). When one mode is prevented, as with the loss of hearing, others can be used.^f

If language evolved, the earliest languages should be the simplest. But language studies show that the more ancient the language (for example: Latin, 200 B.C.; Greek, 800 B.C.; Linear B, 1200 B.C.; and Vedic Sanskrit, 1500 B.C.), the more complex it is with respect to syntax, case, gender, mood, voice, tense, verb forms, and inflection. The best evidence shows that languages devolve; that is, they become simpler instead of more complex.^g Most linguists reject the idea that simple languages evolve into complex languages.^h [See Figure 251 on page 534.]

If humans evolved, then so did language. All available evidence indicates that language did not evolve, so humans probably did not evolve.

14. Speech

Speech is uniquely human.^a Humans have both a “prewired” brain, capable of learning and conveying abstract ideas, and the physical anatomy (mouth, throat, tongue, larynx, etc.) to produce a wide range of sounds. Only a few animals can approximate some human sounds.

Because the human larynx is low in the neck, a long air column lies above the vocal cords. This helps make vowel sounds. Apes cannot make clear vowel sounds, because they lack this long air column. The back of the human tongue, extending deep into the neck, modulates the air flow to produce consonant sounds. Apes have flat, horizontal tongues, incapable of making consonant sounds.^b

Even if an ape could evolve all the physical equipment for speech, that equipment would be useless without a “prewired” brain for learning language skills, especially grammar and vocabulary.

15. Codes, Programs, and Information

In our experience, codes are produced only by intelligence, not by natural processes or chance. A **code** is a set of rules for converting information from one useful form (such as language) to another. Examples include Morse code and Braille. Code makers must simultaneously understand at least two ways of representing information and then establish the rules for converting from one to the other and back again. It is hard to imagine how natural processes and long periods of time could produce even one language. Having two languages form by natural processes and be able to automatically convert one to the other is unbelievable.

The genetic material that controls the physical processes of life is coded information. Also coded are very complex^a and completely different functions: the transmission, translation, correction, and duplication systems, without which the genetic material would be useless, and life would cease.^b It seems obvious that *the genetic code* and the accompanying transmission, translation, correction,

and duplication systems were produced simultaneously in each living organism by an extremely high intelligence.^c

Also, no natural process has ever been observed to produce a program. A **program** is a planned sequence of steps to accomplish some goal. Computer programs are common examples. Because programs require foresight, they are not produced by chance or natural processes. A complex program is stored in the genetic information in every form of life. Therefore, it appears that an unfathomable intelligence created these genetic programs.^d

Life contains matter, energy, and information.^e All isolated systems, including each living organism, has specific, but perishable, amounts of information. No isolated system has ever been shown to increase its information content significantly.^f Nor do natural processes add information; they destroy it. Only outside intelligence can significantly increase the information content of an otherwise isolated system. Thousands of scientific observations are consistent with this generalization, which has three corollaries:

- ◆ Macroevolution cannot occur.^g
- ◆ Outside intelligence was involved in the creation of the universe and all forms of life.^h
- ◆ Life could not result from a “big bang.”ⁱ

16. Compatible Senders and Receivers

As explained above, only intelligence creates codes, programs, and information (CP&I). Each involves senders and receivers. Senders and receivers can be people, animals, plants, organs, cells, or certain molecules. (The DNA molecule is a prolific sender.) The CP&I in a message must be understandable *and* beneficial to both sender *and* receiver *beforehand*; otherwise, the effort expended in transmitting and receiving messages (written, chemical, electrical, magnetic, visual, and auditory) will be wasted.

Consider the astronomical number of links (message channels) that exist between potential senders and receivers: from the cellular level to complete organisms, from bananas to bacteria to babies, since life began. All must have compatible understandings (CP&I) and equipment (matter and energy). Designing compatibilities of this magnitude requires one or more *superintelligences* who completely understand how matter and energy behave over time. In other words, *superintelligence(s)* must have made, or at least mastered, the laws of chemistry and physics wherever senders and receivers are found. The simplest, most parsimonious way to *integrate all of life* is for there to be only one *superintelligence*.

Also, the sending and receiving equipment, including its energy sources, must be in place and functioning before communication begins. But the preexisting equipment provides no benefit until useful messages begin arriving. Therefore, “**In the beginning,**”

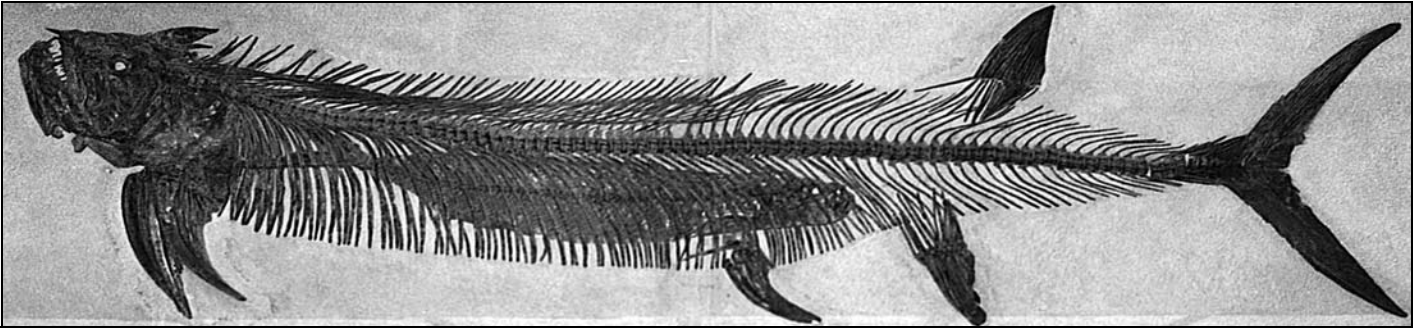

Figure 7: Fish in Long Fish. In the belly of the above 14-foot-long fish is a smaller fish, presumably the big fish's breakfast. Because digestion is rapid, fossilization must have been even more so.



Figure 8: Fish in Curved Fish. The curved back shows that this 3-meter-long fish, *Xiphactinus*, died under stress. Inside it is a 1-meter-long fish.

intelligent foresight (planning) was mandatory—something nature (matter and energy) cannot do, even with an infinite amount of time.

The Arguments for Evolution Are Outdated and Often Illogical.

17. Convergent Evolution or Intelligent Design?

When the same complex capability is found in similar organisms, evolutionists say it evolved from a common ancestor. When the same complex capability is found in dissimilar organisms evolutionists say that *convergent evolution* explains it. With such flexible definitions, evolution can explain many things and not be falsified.

For example, wings and flight occur in some birds, insects, and mammals (bats). Pterosaurs, an extinct reptile, also had wings and could fly. These capabilities have not been found in any of their alleged common ancestors. Other examples of supposedly convergent evolution are the three tiny bones in the ears of mammals: the stapes,



Figure 9: Dragonfly Wing. This delicate, 1½-foot-long wing must have been buried rapidly and evenly to preserve its details. Imagine the size of the entire dragonfly!



Figure 10: Fossil of Fish Swallowing Fish. Burial and fossilization must have been quite rapid to have preserved a fish in the act of swallowing another fish. Thousands of such fossils have been found.

incus, and malleus. Their complex arrangement and precise fit give mammals the unique ability to hear a wide range of sounds. Evolutionists say that those bones evolved from bones in a reptile's jaw. If so, the process must have occurred at least twice^a—but left no known transitional fossils. How did the transitional organisms between reptiles and mammals hear during those millions of years?^b Without the ability to hear, survival—and reptile-to-mammal evolution—would cease.

Concluding that a miracle—or any extremely unlikely event—happened once requires strong evidence or faith; claiming that a similar “miracle” happened repeatedly requires either incredible blind faith or a cause common to each event, such as a common designer.

Furthermore, it is illogical to maintain that similarities between different forms of life always imply a common ancestor;^c such similarities may imply a common designer and show efficient design. In fact, where similar structures are known to be controlled by different genes^d or are developed from different parts of embryos,^e a common designer is a much more likely explanation than evolution.

18. Vestigial Organs

Some structures in humans were once thought to have no function, but to have once been useful in some evolutionary ancestor.^a They were called *vestigial organs*. As medical knowledge has increased, at least some function has been discovered for all alleged vestigial organs.^b For example, the human appendix was once considered a useless remnant from our evolutionary past. The appendix plays a role in antibody production, protects part of the intestine from infections and tumor growths,^c and safely stores “good bacteria” that can replenish the intestines following bouts of diarrhea.^d The absence of true vestigial organs implies evolution never happened.

19. Two-Celled Life?

No fully developed form of life has 2, 3, 4, or 5 cells.^a Forms of life with 6–20 cells are parasites, so they must have a complex animal as a host to provide such functions as respiration and digestion. If macro-evolution happened, one should find many fully developed forms of animal life with 2–20 cells—filling the gap between one-celled and many-celled organisms.

20. Embryology

Since 1868, evolutionists have taught that developing embryos pass through stages that mimic an evolutionary sequence. In other words, in a few weeks an unborn human repeats stages that supposedly took millions of years of evolution for mankind. A well-known example of this ridiculous teaching is that embryos of mammals have “gill slits,” because mammals supposedly evolved from fish. Embryonic tissues that resemble “gill slits” have nothing to do with breathing; they are neither gills nor slits. Instead, those embryonic tissues develop into parts of the face, bones of the middle ear, and endocrine glands.

Embryologists no longer consider the superficial similarities between a few embryos and the adult forms of simpler animals as evidence for evolution.^a Ernst Haeckel, by deliberately falsifying his drawings,^b originated and popularized this incorrect but widespread belief. Many modern textbooks continue to spread this false idea as evidence for evolution.^c

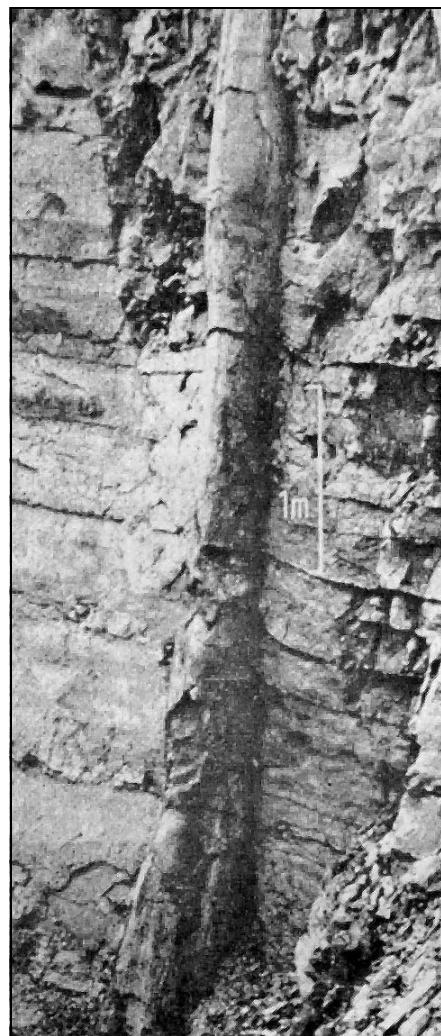

Figure 11: Polystrate Fossil. Fossils crossing two or more sedimentary layers (strata) are called *poly* (many)-*strate* (strata) fossils. Consider how quickly this 11-foot-tall tree trunk in Germany must have been buried. Had burial been slow, the tree top would have decayed. Obviously, the tree could not have grown up through the strata without sunlight and air. The only alternative is **rapid burial**. Some polystrate trees are upside down, which could occur in a large flood. Soon after Mount St. Helens erupted in 1980, scientists saw trees being buried in a similar way in the lake-bottom sediments of Spirit Lake. Polystrate tree trunks are found worldwide. (Notice the 1-meter-scale bar, equal to 3.28 feet, in the center of the picture.)

21. Rapid Burial

Fossils all over the world show evidence of rapid burial. Many fossils, such as fossilized jellyfish,^a show by the details of their soft, fleshy portions^b that they were buried rapidly, before they could decay. (Normally, dead animals and plants quickly decompose.) The presence of fossilized remains of many other animals, buried in mass graves and lying in twisted and contorted positions, suggests violent and rapid burials over large areas.^c These observations, plus the occurrence of compressed fossils and fossils that cut

across two or more layers of sedimentary rock, are strong evidence that the sediments encasing these fossils were deposited rapidly—not over hundreds of millions of years. Furthermore, almost all sediments that formed today’s rocks were sorted by water. The worldwide fossil record is, therefore, evidence of rapid death and burial of animal and plant life by a worldwide, catastrophic flood. The fossil record is not evidence of slow change or evolution.^d [See “A Whale of a Tale” on page 137.]

22. Parallel Strata

Earth’s sedimentary layers are typically parallel to adjacent layers. Such uniform layers are seen, for example, in the Grand Canyon and in road cuts in mountainous terrain. Had these parallel layers been deposited slowly over thousands of years, erosion would have cut many channels in the topmost layers. Their later burial by other sediments would produce nonparallel patterns. Because parallel layers are the general rule, and Earth’s surface erodes rapidly, one can conclude that almost all sedimentary layers were deposited rapidly relative to the local erosion rate—not over long periods of time. (The mechanism involved is explained on pages 195–213.)

23. Fossil Gaps

If evolution happened, the fossil record should show continuous and gradual changes from the bottom to the top layers. Actually, many gaps or discontinuities appear throughout the fossil record.^a At the most fundamental level, a big gap exists between forms of life whose cells have nuclei (eukaryotes, such as plants, animals, and fungi) and those that don’t (prokaryotes, such as bacteria and blue-green algae).^b Fossil links are also missing between large groupings of plants,^c between single-celled forms of life and invertebrates (animals without backbones), among insects,^d between invertebrates and vertebrates (animals with backbones),^e between fish and amphibians,^f between amphibians and reptiles,^g between reptiles and mammals,^h between reptiles and birds,ⁱ between primates and other mammals,^j and between apes and other primates.^k In fact, *chains* are missing, not *links*. The fossil record has been studied so thoroughly that it is safe to conclude that these gaps are real; they will never be filled.^l

24. The Cambrian Explosion

The “evolutionary tree” has no trunk. In what evolutionists call the earliest part of the fossil record (generally the lowest sedimentary layers of Cambrian rock), life appears suddenly, full-blown, complex, diversified,^a and dispersed—worldwide.^b Evolution predicts that minor variations should slowly accumulate, eventually becoming major categories of organisms. Instead, the opposite is found.

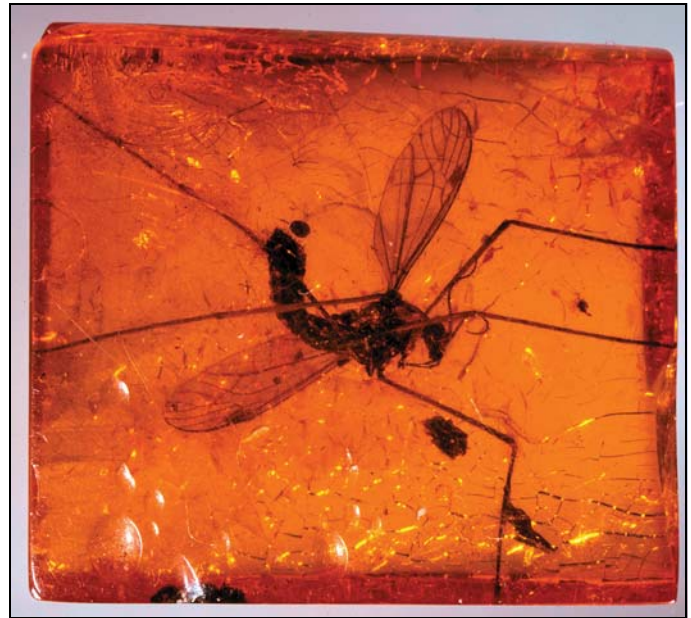

Figure 12: Insect in Amber. The best-preserved fossils are encased in amber, protected from air and water, and buried in the ground. Amber, a golden resin (similar to sap or pitch) usually from conifer trees, such as pines, may also contain other preservatives. Significantly, *no transitional forms of life have been found in amber, despite evolutionary-based ages of 1.5–300-million years.* (According to evolution, there should be millions.) Animal behaviors, unchanged from today, are seen in three-dimensional detail. For example, ants in amber show the same social and work patterns as ants today.

Experts bold enough to explain how these fossils formed say that hurricane-force winds must have snapped off trees at their trunks, causing huge amounts of resin to spill out and act like flypaper. Debris and small organisms were blown into the sticky resin, which was later covered by more draining resin and finally buried. (Part II of this book will show that such conditions arose as the flood began.)

In a clean-room laboratory, 30–40 dormant, *but living*, bacteria species were removed from intestines of bees encased in amber from the Dominican Republic. When cultured, the bacteria grew! [See “**Old DNA, Bacteria, and Proteins?**” on page 38.] This amber is claimed to be 25–40-million years old, but I suspect it formed at the beginning of the flood, only thousands of years ago. Is it more likely that bacteria can be kept alive thousands of years or many millions of years? Metabolism rates, even in dormant bacteria, are not zero.

Almost all of today’s plant and animal phyla—including flowering plants,^c vascular plants,^d and vertebrates^e—appear at the base of the fossil record. In fact, many more phyla are found in the Cambrian than exist today.^f Complex species, such as fish,^g worms, corals, trilobites, jellyfish,^h sponges, mollusks, and brachiopods appear suddenly, with no sign anywhere on Earth of gradual development from simpler forms. Insects, a class comprising four-fifths of all known animal species (living and extinct), have no known evolutionary ancestors.ⁱ Insects and other arthropods found in amber, supposedly 100–230 million-years-old, look like those living today.^j The fossil record does not support evolution.^k

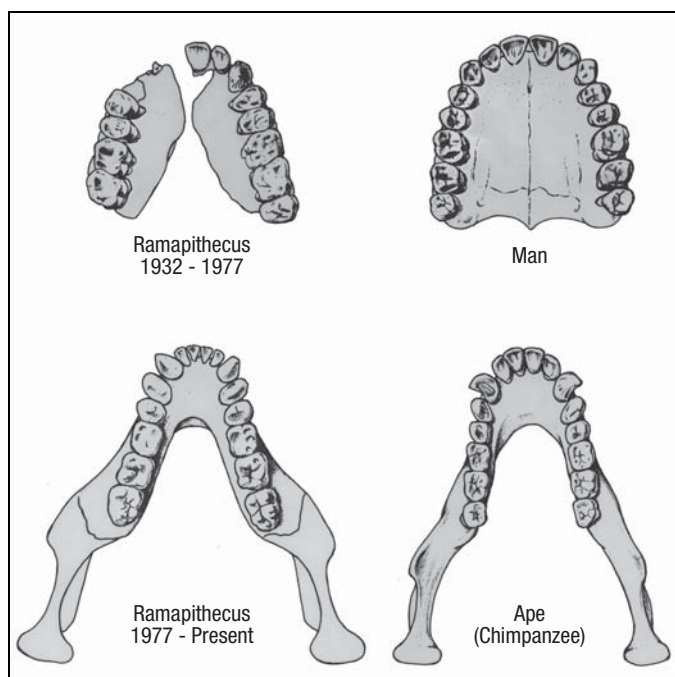

Figure 13: *Ramapithecus*. Some textbooks still claim that *Ramapithecus* is man's ancestor, an intermediate between man and some apelike ancestor. This mistaken belief resulted from piecing together, in 1932, fragments of upper teeth and bones into the two large pieces shown in the upper left. This was done so the shape of the jaw resembled the parabolic arch of man, shown in the upper right. In 1977, a complete lower jaw of *Ramapithecus* was found. The true shape of the jaw was not parabolic, but rather U-shaped, distinctive of apes.

25. Out-of-Sequence Fossils

Frequently, fossils are not vertically sequenced in the assumed evolutionary order.^a For example, in Uzbekistan, 86 consecutive hoofprints of horses were found in rocks dating back to the dinosaurs.^b A leading authority on the Grand Canyon published photographs of horselike hoofprints visible in rocks that, according to the theory of evolution, predate hooved animals by more than 100-million years.^c Dinosaur and humanlike footprints were found together in Turkmenistan^d and Arizona.^e Sometimes, land animals, flying animals, and marine animals are fossilized side-by-side in the same rock.^f Dinosaur, whale, elephant, horse, and other fossils, plus crude human tools, have reportedly been found in phosphate beds in South Carolina.^g Coal beds contain round, black lumps called *coal balls*, some of which contain flowering plants that allegedly evolved 100-million years after the coal bed was formed.^h Amber, found in Illinois coal beds, contain chemical signatures showing that the amber came from flowering plants, but flowering plants supposedly evolved 170-million years after the coal formed.ⁱ In the Grand Canyon, in Venezuela, in Kashmir, and in Guyana, spores of ferns and pollen from flowering plants are found in Cambrian^j rocks—rocks supposedly deposited before

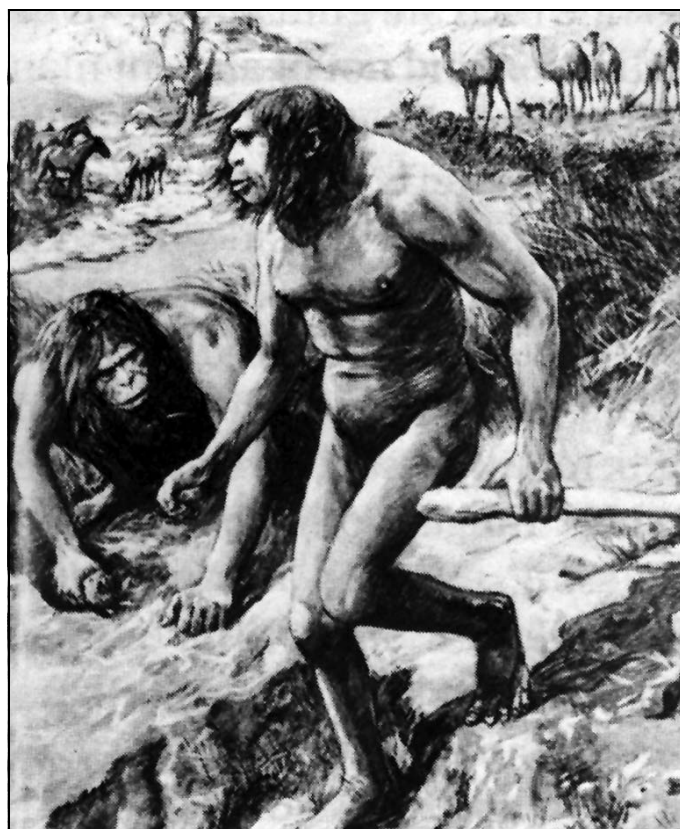

Figure 14: Nebraska Man. Artists' drawings, even those based on speculation, powerfully influence the public. Nebraska man was mistakenly based on one tooth^h of an extinct pig. Yet in 1922, *The Illustrated London News* published this picture showing our supposed ancestors. Of course, it is highly unlikely that any fossil evidence could support the image conveyed here of a naked man carrying a club.

flowering plants evolved. Pollen has also been found in Precambrian^k rocks deposited before life allegedly evolved.

Petrified trees in Arizona's Petrified Forest National Park contain fossilized nests of bees and cocoons of wasps. The petrified forests are reputedly 220-million years old, while bees (and flowering plants, which bees require) supposedly evolved almost 100-million years later.^l Pollinating insects and fossil flies, with long, well-developed tubes for sucking nectar from flowers, are dated 25-million years before flowers are assumed to have evolved.^m Most evolutionists and textbooks systematically ignore discoveries which conflict with the evolutionary time scale.

26. Ape-Men?

For over a century, studies of skulls and teeth have produced unreliable conclusions about man's origin.^a Also, fossil evidence allegedly supporting human evolution is fragmentary and open to other interpretations. Fossil evidence showing the evolution of chimpanzees, supposedly the closest living relative to humans, is nonexistent.^b

Stories claiming that fossils of primitive, apelike men have been found are overstated.^c

- ◆ Since 1953, it has been universally acknowledged that Piltdown “man” was a hoax, yet Piltdown “man” was in textbooks for more than 40 years.^d
- ◆ Before 1977, evidence for *Ramapithecus* was a mere handful of teeth and jaw fragments. We now know these fragments were pieced together incorrectly by Louis Leakey^e and others into a form resembling part of the human jaw.^f *Ramapithecus* was just an ape.^g [See [Figure 13](#).]
- ◆ The only remains of Nebraska “man” turned out to be a single tooth^h—of a pig. [See [Figure 14](#).]
- ◆ Forty years after he discovered Java “man,” Eugene Dubois conceded that it was not a man, but was similar to a large gibbon (an ape). In citing evidence to support this new conclusion, Dubois admitted that he had withheld parts of four other thigh bones of apes found in the same area.ⁱ
- ◆ Many experts consider the skulls of Peking “man” to be the remains of apes that were systematically decapitated and exploited for food by true man.^j Its classification, *Homo erectus*, is considered by most experts to be a category that should never have been created.^k
- ◆ Heidelberg man (*Homo heidelbergensis*), supposedly our ancestor, was based on one lower jaw. Many researchers now feel the species should be eliminated.^l
- ◆ The first confirmed limb bones of *Homo habilis* were discovered in 1986. They showed that this animal clearly had apelike proportions^m and should never have been classified as manlike (*Homo*).ⁿ
- ◆ The australopithecines, made famous by Louis and Mary Leakey, are quite distinct from humans. Several detailed computer studies of australopithecines have shown that their bodily proportions were not intermediate between those of man and living apes.^o Another study showed that their inner ear bones, used to maintain balance, were strikingly similar to those of chimpanzees and gorillas, but differed greatly from those of humans.^p Also, their pattern of dental development corresponds to chimpanzees, not humans.^q Claims were made—based on one partially complete australopithecine fossil, *Australopithecus afarensis* (a 3½-foot-tall, long-armed, 60-pound adult called *Lucy*)—that all australopithecines walked upright in a human manner. However, studies of Lucy’s entire anatomy, not just a knee joint, now show that this is very unlikely. She likely swung from the trees^r and was similar to pygmy chimpanzees.^s In 2006, a partial *Australopithecus afarensis* specimen—a 3-year-old baby—with clear apelike features—was announced.^t The australopithecines are probably extinct apes.^u
- ◆ For about 100 years, the world was led to believe that Neanderthal man was stooped and apelike. This false idea was based upon some Neanderthals with bone diseases, such as arthritis and rickets.^v Recent dental

and x-ray studies of Neanderthals suggest that they were humans who matured at a slower rate and lived to be much older than people today.^w Neanderthal man, Heidelberg man, and Cro-Magnon man are now considered completely human. Artists’ drawings of “ape-men,” especially their fleshy portions, are often quite imaginative and are not supported by the evidence.^x

Furthermore, the techniques used to date these fossils are highly questionable. [See [pages 36–43](#).]

27. Fossil Man

Bones of modern-looking humans have been found deep in undisturbed rocks that, according to evolution, were formed long before man began to evolve. Examples include the Castenedolo skeletons,^a Reck’s skeleton,^b and possibly others.^c Remains, such as the Swanscombe skull, the Steinheim fossil, and the Vertesszöllos fossil present similar problems.^d Evolutionists almost always ignore these remains.

Life Is So Complex That Chance Processes, Even over Billions of Years, Cannot Explain How Life Began.

28. Chemical Elements of Life

The chemical evolution of life, as you will see in the next few pages, is ridiculously improbable. What could improve the odds? One should begin with an Earth having high concentrations of the key elements comprising life, such as carbon, oxygen, and nitrogen.^a However, the more closely one examines these elements, the more unlikely evolution appears.

Carbon. Rocks that supposedly preceded life have very little carbon.^b One must imagine a toxic, carbon-rich atmosphere to supply the needed carbon if life evolved. For comparison, today’s atmosphere holds only 1/80,000 of the carbon that has been on Earth’s surface since the first fossils formed. [See [Table 8 on page 262](#).]

Oxygen. No evolutionary theory has been able to explain why Earth’s atmosphere has so much oxygen. Too many substances on an evolving Earth would have oxidized (absorbed oxygen) over billions of years.^c If the early Earth had oxygen in its atmosphere, compounds (called *amino acids*), which are absolutely necessary for life, would have been destroyed by oxidation.^d But if there had been no oxygen, there would have been no ozone (O₃—a form of oxygen) in the upper atmosphere. Without ozone to shield Earth, the Sun’s ultraviolet radiation would quickly destroy life.^e The only known way for both ozone and life to be here is for both to come into existence almost simultaneously—in other words, by creation.

Nitrogen. Clays and various rocks absorb nitrogen. Had millions of years passed before life evolved, the sediments that preceded life should be filled with nitrogen. Searches have never found such sediments.^f

While 78% of Earth's atmosphere is nitrogen, the means by which plants, animals and bacteria evolved ways to use it in their bodies, is a recognized evolutionary mystery.^g

Basic chemistry does not support the evolution of life.^h

29. Proteins

Living matter is composed largely of proteins, which are long chains of amino acids. Since 1930, it has been known that amino acids cannot link together if oxygen is present. That is, proteins could not have evolved from chance chemical reactions if the atmosphere contained oxygen. However, the chemistry of Earth's rocks, both on land and below ancient seas, shows that Earth had oxygen before the earliest fossils formed.^a Even earlier, solar radiation would have broken some water vapor into oxygen and hydrogen. Some hydrogen, the lightest of all chemical elements, would then have escaped into outer space, leaving behind excess oxygen.^b

To form proteins, amino acids must also be highly concentrated in an extremely pure liquid.^c However, the early oceans or ponds would have been far from pure and would have diluted amino acids, so the required collisions between amino acids would rarely occur.^d Besides, amino acids do not naturally link up to form proteins. Instead, proteins tend to break down into amino acids.^e Furthermore, the proposed energy sources for forming proteins (Earth's heat, electrical discharges, or solar radiation) destroy the protein products thousands of times faster than they could have formed.^f The many attempts to show how life might have arisen on Earth have instead shown (a) the futility of that effort,^g (b) the immense complexity of even the simplest life,^h and (c) the need for a vast intelligence to precede life.

Finally, all organisms, from bacteria to humans, produce their proteins in tinyⁱ manufacturing plants called ribosomes that are in most of their cells. Because proteins comprise almost half of each ribosome, how were ribosomes created?^j Obviously, living cells and their ribosomes had to be created simultaneously.

30. The First Cell

If, despite virtually impossible odds, proteins arose by chance processes, there is not the remotest reason to believe they could ever form a membrane-encased, self-reproducing, self-repairing, metabolizing, living cell.^u There is no evidence that any stable states exist between the assumed formation of proteins and the formation of the first living cells. No scientist has ever demonstrated that this fantastic jump in complexity could have happened—even if the entire universe had been filled with proteins.^b

31. Barriers, Buffers, and Chemical Pathways

Living cells contain thousands of different chemicals, some acidic, others basic. Many chemicals would react with others unless an intricate system of chemical barriers and buffers already existed. If living things evolved, these barriers and buffers must also have evolved—but at just the right time to prevent harmful chemical reactions. How could such precise, seemingly coordinated, virtually miraculous events have happened for each of millions of species?^a

All living organisms are maintained by thousands of chemical pathways, each involving a long series of complex chemical reactions. For example, the clotting of blood, which involves 20–30 steps, is absolutely vital to healing a wound. However, clotting could be fatal if it happened inside the body. Omitting one of the many steps, inserting an unwanted step, or altering the timing of a step would probably cause death. If one thing goes wrong, all the marvelous steps that worked flawlessly up to that point would have been in vain. Evidently, these complex pathways were created as an intricate, highly integrated system.^b

32. Genetic Distances

Similarities between different forms of life can now be measured.

Proteins. “Genetic distances” can be calculated by taking a specific protein and examining the sequence of its components. The fewer changes needed to convert a protein of one organism into the corresponding protein of another organism, supposedly the closer their relationship. These studies seriously contradict the theory of evolution.^a

An early computer-based study of cytochrome c, a protein used in energy production, compared 47 different forms of life. This study found many contradictions with evolution based on this one protein. For example, according to evolution, the rattlesnake should have been most closely related to other reptiles. Instead, of these 47 forms (all that were sequenced at that time), the one most similar to the rattlesnake was man.^b Since this study, experts have discovered hundreds of similar contradictions.^c

DNA and RNA. Comparisons can also be made between the genetic material of different organisms. The list of organisms that have had all their genes sequenced and entered in databases, such as “GenBank,” is doubling each year. Computer comparisons of each gene with all other genes in the database show too many unrelated genes.^d Therefore, an evolutionary relationship between genes is highly unlikely. Furthermore, there is no trace at the molecular level for the traditional evolutionary series:^e simple sea life → fish → amphibians → reptiles → mammals. Each organism appears to be almost equally isolated.^f

Follow the Money

The public is generally unaware that most scientists and university researchers are continually scrambling to find a governmental agency, corporation, or individual to fund their research. Grant money is needed to pay the scientists' salaries and attract others to come work for them. Researchers' jobs, power, and prestige depend on that funding. Used car salesmen have gotten a bad name for the dishonest claims by a few. The evolutionist community, in the pursuit of grant money, is worse.^a [See "[The Elephant in the Living Room](#)" on page 17.]

Evolutionist Lynn Margulis (1938–2011), a famous University of Massachusetts biology professor and the former wife of Carl Sagan, describes a conversation she had with Richard Lewontin, a leading evolutionary biologist:^b

"Population geneticist Richard Lewontin gave a talk here at University of Massachusetts, Amherst, about 6 years ago, and he mathematized all of it—changes in the population, random mutation, sexual selection, cost and benefit. At the end of his talk he said, 'You know, we've tried to test these ideas in the field and the lab, and there are really no measurements that match the quantities I've told you about.' This just appalled me. So I said, 'Richard Lewontin, you are a great lecturer to have the courage to say it's gotten you nowhere. But then why do you continue to do this work? He looked around and said, 'It's the only thing I know how to do, and if I don't do it, I won't get my grant money.' So he's an honest man, and that's an honest answer." [emphasis added]

Lewontin's example is just the tip of the iceberg. The United States government doles out more than five billion dollars each year to universities for evolutionary-based research—research that assumes evolution, or will attempt to solve problems resulting from accepting evolution. Research universities do not hire professors who openly question evolution. Other financial incentives motivate evolutionists, such as the 25-billion-dollar-a-year-textbook industry, which greatly increases an author's ability to receive a prestigious and lucrative professorship and grants. (One reason college textbooks are so outrageously expensive is that each has such a small market—sometimes just the professor's students.) Hundreds of other examples could be given.

Public school teachers caught teaching *scientific evidence* opposing evolution or supporting creation and the flood are often fired, because their supervisors fear million-dollar ACLU lawsuits that falsely allege the teaching of religion—lawsuits whose lawyers' fees alone would

bankrupt the school district. (Presenting verifiable physical scientific evidence is not the same as telling students to believe in a religion.) Private schools are less vulnerable to such pressure, because they are not publicly funded. Who are the losers in this financial web? Students, taxpayers, scientific progress, and truth.

Most of these universities have offices that continually feed press releases and video clips to the media describing the scientific work of their faculties. These releases frequently contain evolutionary ideas, as if they are widely accepted facts that all educated people understand. When the media want information or verification for a possible story, they often call these universities for assistance. The media office usually asks a professor familiar with the specific subject to call the reporter for a live interview. Not only does this quickly give an editor or producer confidence to print or broadcast a story, it enhances the stature of the professor, his or her academic department, the university, the media outlet, and the reporter. Everyone seemingly wins—if the story is accurate. If the story is inaccurate, as is often the case when evolution is pushed, the misinformed public is the loser. Media that release a story citing evidence opposing evolution are often inundated with intimidating complaints, many orchestrated by those in the university.

Universities also have offices that seek and coordinate grant-seeking efforts. Typically 50% of every research grant is for the university's overhead. The remainder is for the researcher's salary and research. If a professor does not bring in enough in grants, his income is reduced and his job is in jeopardy. So universities have a powerful financial incentive to promote their research. Because it often involves evolution, they almost never hire someone who openly opposes evolution. Naturally, most students graduating from these universities become evolutionists. Some become professors.

Despite these powerful financial incentives and people like Lewontin promoting evolution, the American public has generally rejected evolution. [See Endnote 1 and Figure 254 on page 558.] Also, the history of science shows that scientific controversies are eventually resolved, sometimes after centuries, in favor of the side with the strongest evidence. The 131 categories of evidence listed in just Part I of this book are not going away. Genetic information alone (Category 33), if understood, would settle the matter.

Can you see why evolutionists will not enter a publishable, strictly scientific debate on the creation-evolution issue? [See "[What Is the Written Debate Offer?](#)" on page 570.]

Humans vs. Chimpanzees. Evolutionists say the chimpanzee is the closest living relative to humans. For two decades (1984–2004), evolutionists and the media claimed that

human DNA is about 99% similar to chimpanzee DNA. These false statements had little scientific justification, because they were made before anyone had completed the

The Elephant in the Living Room

Writer George V. Caylor interviewed Sam, a molecular biologist. George asked Sam about his work. Sam said he and his team were scientific detectives, working with DNA and tracking down the cause of disease. Here is their published conversation.^a

G: “Sounds like pretty complicated work.”

S: “You can’t imagine how complicated!”

G: “Try me.”

S: “I’m a bit like an editor, trying to find a spelling mistake inside a document larger than four complete sets of *Encyclopedia Britannica*. Seventy volumes, thousands and thousands of pages of small print words.”

G: “With the computer power, you can just use ‘spell check!’”

S: “There is no ‘spell check’ because we don’t know yet how the words are supposed to be spelled. We don’t even know for sure which language. And it’s not just the ‘spelling error’ we’re looking for. If any of the punctuation is out of place, or a space out of place, or a grammatical error, we have a mutation that will cause a disease.”

G: “So how do you do it?”

S: “We are learning as we go. We have already ‘read’ over two articles in that encyclopedia, and located some typos. It should get easier as time goes by.”

G: “How did all that information happen to get there?”

S: “Do you mean, did it just happen? Did it evolve?”

G: “Bingo. Do you believe that the information evolved?”

Notice in this example, and in “Follow the Money” on page 16, how easy it is to become intellectually dishonest when you have an inflated view of your work and prestige—and you and others around you realize that your work’s foundational assumption—evolution—has major (and quite likely, fatal) scientific problems.

S: “George, nobody I know in my profession truly believes it evolved. It was engineered by ‘genius beyond genius,’ and such information could not have been written any other way. The paper and ink did not write the book. Knowing what we know, it is ridiculous to think otherwise. A bit like Neil Armstrong believing the moon is made of green cheese. He’s been there!”

G: “Have you ever stated that in a public lecture, or in any public writings?”

S: “No. It all just evolved.”

G: “What? You just told me —?”

S: “Just stop right there. To be a molecular biologist requires one to hold on to two insanities at all times. One, it would be insane to believe in evolution when you can see the truth for yourself. Two, it would be insane to say you don’t believe in evolution. **All government work, research grants, papers, big college lectures—everything would stop. I’d be out of a job, or relegated to the outer fringes where I couldn’t earn a decent living.**” [emphasis added]

G: “I hate to say it, Sam, but that sounds intellectually dishonest.”

S: “The work I do in genetic research is honorable. We will find the cures to many of mankind’s worst diseases. But in the meantime, we have to live with the ‘elephant in the living room.’”

G: “What elephant?”

S: “Design. It’s like the elephant in the living room. It moves around, takes up an enormous amount of space, loudly trumpets, bumps into us, knocks things over, eats a ton of hay, and smells like an elephant. And yet we have to swear it isn’t there!”

sequencing of human DNA and long before the sequencing of chimpanzee DNA had begun.

Chimpanzee and human DNA have now been completely sequenced and compared. The *overall* differences, which are far greater and more complicated than evolutionists suspected,⁸ include about “thirty-five million single-nucleotide changes, five million insertions or deletions, and various chromosomal rearrangements.”^h Although only 4% of human and chimpanzee DNA differ, those critical differences amount to a vast chasm.

Moreover, differences between the male portion of the human and chimpanzee sex chromosome are huge! Only 30% of the DNA sequences in the male portion of the human sex chromosome overlap with those in the chimpanzee

sex chromosome. Even overlaps contain massive genetic rearrangements.ⁱ The genetic differences are comparable to those between nonsex chromosomes in chickens and humans.^j Also, humans shuffle male and female DNA to their offspring in different ways than chimpanzees do.^k

In summary, the standard evolutionary trees, based on the outward appearance of organisms, differ considerably from comparisons based on genetic information.^l

33. Genetic Information

Natural processes cannot produce large amounts of information. The genetic information in the DNA of each human cell is roughly equivalent to a library of 4,000 books.^a

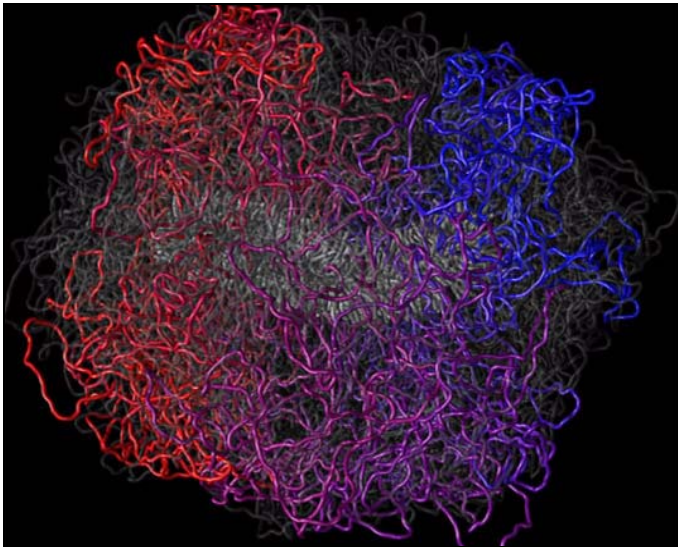

Figure 15: The Third Dimension. Shown above is an artist's representation of the DNA (totaling 7 feet in length) which is stuffed inside the nucleus in each of about 30,000,000,000,000 (thirty trillion) cells in your body. Each color represents the DNA in one of 23 pairs of chromosomes. The amount of information in that DNA is staggering; it is the equivalent of about 4,000 books.^a For a human, 3 billion letters^b must be precisely sequenced. (Imagine the total information in all animals and plants.) Each strand is folded in three-dimensional shapes (or loops) that bring tiny segments of DNA close to other segments with which they must interact. Amazingly, the folding is different for each type of cell in your body! Before a cell can divide, this DNA must be refolded into two separate cylindrical shapes, all without tangling.^c (Refolding takes about 15 minutes.) Although this has been filmed,^d how it happens and functions almost flawlessly is currently unknown.^e **Complexity is superimposed upon complexity—all within a volume that is less than one ten-thousandth the size of a grain of sand!**^f

How could any reasonable person claim that this unfathomable complexity arose by chance through natural processes (in other words, evolution)—even over billions of years? Clearly, it is irrefutable evidence of a Designer Whose intelligence is beyond our comprehension!

Even if matter and life somehow arose—perhaps only a bacterium—the probability that mutations and natural selection produced this vast amount of information is essentially zero.^g It would be similar to producing 4,000 books with the following procedure:^h

- a. Start with a meaningful phrase.
- b. Retype the phrase, but add letters and make some errors.
- c. See if the new phrase is meaningful.
- d. If it is, replace the original phrase with it.
- e. Return to step “b.”

To produce just the enzymes in one organism would require more than $10^{40,000}$ trials.ⁱ (To begin to understand how large $10^{40,000}$ is, realize that the visible universe contains fewer than 10^{80} atoms.)

In 1972,^j evolutionists, out of ignorance,^k began referring to large segments of DNA as “junk” DNA, because it supposedly had no purpose and was left over from our

evolutionary past. What evolutionists called “junk” DNA is now known to contain millions of switches that regulate gene activity at specific times and in unique ways for each of thousands of different types of cells. Most genetic changes that cause disease lie outside the genes and on the 95% of the DNA that evolutionists used to call “junk.”^l

In humans, 2,000 genes are “indispensable for viability.” They are required “for basic cellular functions such as cell division, transcription, translation, DNA replication, cycle control, and fundamental metabolism.”^m Suppose, after millions of years, 1999 of these essential genes had evolved, but one had not yet evolved. What would have happened? Extinction! Human evolution would have had to start all over again. Life's complexity is mind boggling—not something that random processes could ever produce. Obviously, all 2,000 had to come into existence simultaneously. But that is creation!

Based on all known experience—scientific or otherwise—information comes only from intelligence. Vast amounts of information require a vast intelligence.

34. Handedness: Left and Right

Genetic material (DNA and RNA) is composed of nucleotides. In living things, nucleotides are always “right-handed.” (They are called *right-handed*, because a beam of polarized light passing through them rotates like a right-handed screw.) Nucleotides rarely form outside life, but when they do, half are left-handed, and half are right-handed. If the first nucleotides formed by natural processes, they would have “mixed-handedness” and therefore could not evolve life's genetic material. In fact, “mixed” genetic material cannot even copy itself.^a

Each type of *amino acid*, when found in nonliving material or when synthesized in the laboratory, comes in two chemically equivalent forms. Half are right-handed, and half are left-handed—mirror images of each other. However, amino acids in life, including plants, animals, bacteria, molds, and even viruses, are almost all left-handed^b—*except in some diseased or aging tissue.*^c No known natural process can isolate either the left-handed or right-handed variety. The mathematical probability that chance processes could produce merely one tiny protein molecule with only left-handed amino acids is virtually zero.^d

A similar observation can be made for a special class of organic compounds called *sugars*. In living systems, sugars are all right-handed. Based on our present understanding, natural processes produce an equal number of left-handed and right-handed sugars. Because sugars in living things are right-handed, random natural processes apparently did not produce life.

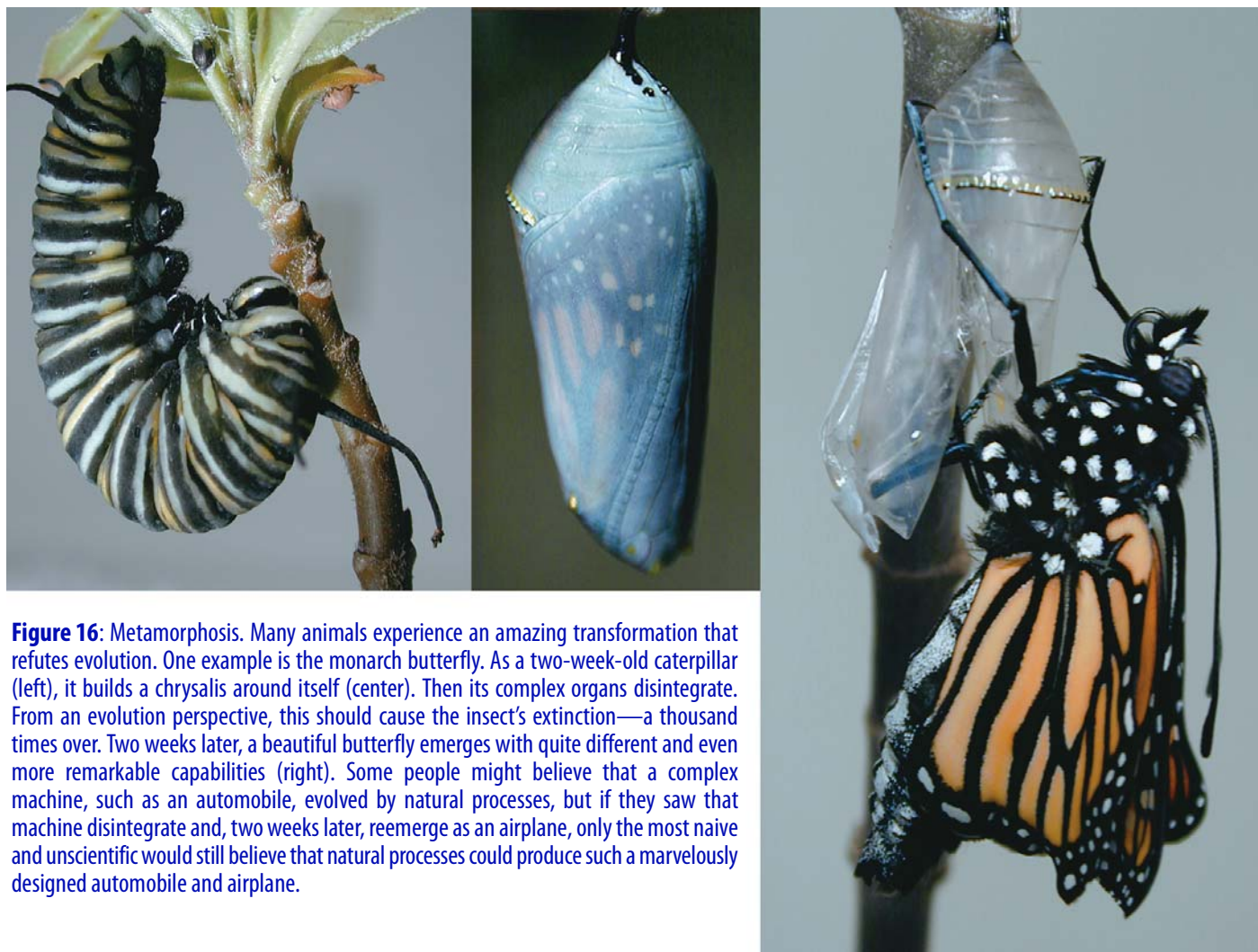

Figure 16: Metamorphosis. Many animals experience an amazing transformation that refutes evolution. One example is the monarch butterfly. As a two-week-old caterpillar (left), it builds a chrysalis around itself (center). Then its complex organs disintegrate. From an evolution perspective, this should cause the insect's extinction—a thousand times over. Two weeks later, a beautiful butterfly emerges with quite different and even more remarkable capabilities (right). Some people might believe that a complex machine, such as an automobile, evolved by natural processes, but if they saw that machine disintegrate and, two weeks later, reemerge as an airplane, only the most naive and unscientific would still believe that natural processes could produce such a marvelously designed automobile and airplane.

Table 1. Contrast between a Typical Larva and Adult

Larva	Adult Insect
a chewing mouth	a sucking tube
a few simple eyes	two compound eyes (often with thousands of lenses capable of seeing all colors and ultraviolet light in almost all directions)
no true legs	six segmented legs
can't reproduce	reproduces
a crawler	a capable flyer

If any living thing took in (or ate) amino acids or sugars with the wrong handedness, the organism's body could not process it. Such food would be useless, if not harmful. Because slight variations, that enhance survivability and reproduction, supposedly produce macroevolution, consider how beneficial a mutation might be that switched (or inverted) a plant's handedness. "Inverted" (or wrong-handed) trees would proliferate rapidly, because they would no longer provide nourishment to bacteria, mold, or termites. "Inverted" forests would fill continents. Other "inverted" plants and animals would also benefit and would

overwhelm the balance of nature. Why do we not see such species with right-handed amino acids and left-handed sugars? Similarly, why are there not more poisonous plants? Why don't beneficial mutations enable most carriers to defeat their predators? Beneficial mutations are rarer than most evolutionists believe. [See "Mutations" on page 7.]

35. Metamorphosis

Most insects (87%) undergo complete metamorphosis. It begins when a larva (such as a caterpillar) builds a cocoon around itself. Then, its body inside disintegrates into a thick, pulplike liquid. Days, weeks, or months later, the adult insect emerges—one that is dramatically different (as shown in Table 1), amazingly capable, and often beautiful, such as a butterfly. Food, habitat, and behavior of the larva also differ drastically from those of the adult.

Evolution claims that:

Mutations slightly alter an organism's genetic material, which later generations inherit. On rare occasions the alterations are beneficial, enabling those offspring to reproduce more of themselves and the improved

genetic material. After many generations, dramatic changes—even new organs—accumulate.

If this were true, each organism would have to be able to reproduce and be superior, in some sense, to its ancestors. How then could metamorphosis evolve in many stages?^a

What mutations could improve a larva? Certainly, none that destroyed its nerves, muscles, eyes, brain, and most other organs, as occurs within a cocoon. So, even if a larva improved, it later ends up as “mush.” From an evolutionary standpoint, liquefying complex organs is a giant step backwards. As Michael Pitman wryly noted,

Maggots will more or less dissolve themselves when developing into a fly. Was the process pre-programmed from the first “production run”? Or was the ancestral fly a dissolved maggot?^b

The millions of changes inside the thick liquid never produce something survivable or advantageous in the outside world until the adult completely forms. How did the genetic material for both larva and adult develop? Which came first, larva or adult? What mutations could transform a crawling larva into a flying monarch butterfly that can accurately navigate 3,000 miles using antennae and a tiny brain?^c Indeed, why should a larva evolve in the first place, because it cannot reproduce?^d

Charles Darwin wrote,

If it could be demonstrated that any complex organ existed which could not possibly have been formed by numerous successive, slight modifications, my theory would absolutely break down.^e

Based on metamorphosis alone, evolution “breaks down.”

Obviously, the vast amount of information that directs every stage of a larva’s and an adult’s development, including metamorphosis, must reside in its genetic material at the beginning. This fits only creation.

36. DNA and Proteins

DNA cannot function without hundreds of preexisting proteins,^a but proteins are produced only at the direction of DNA.^b Because each needs the other, a satisfactory explanation for the origin of one must also explain the origin of the other.^c Therefore, the entire manufacturing system—and its products—must have come into existence simultaneously. This implies creation.

Some of these necessary proteins decode the DNA, store DNA (histone spools), transcribe DNA into messenger RNA, assemble proteins (ribosomes), and protect DNA and its products (cell membranes).^d These systems, present in each cell, are extremely complex.

One of the most studied proteins in mammals, including humans, is called p53. It binds to thousands of DNA sites and influences cell growth, death, and structure. It is involved in fertility and early embryonic development. It also stifles cancers by repairing DNA, suppressing tumors,

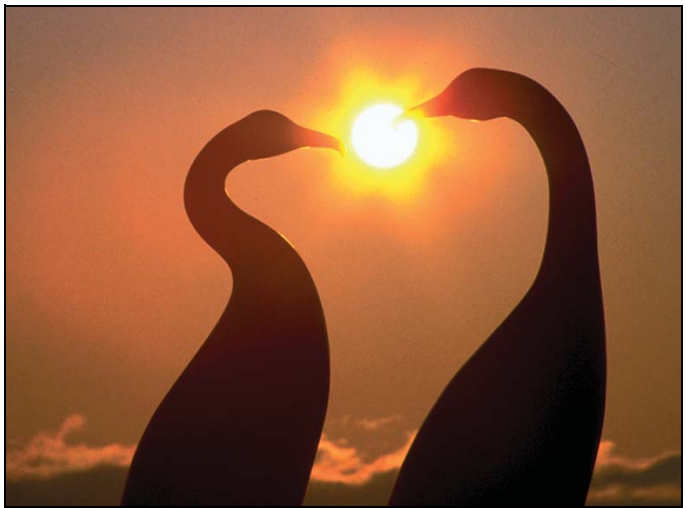

Figure 17: Male and Female Birds. Even evolutionists admit that evolution seems incompatible with sexual reproduction. For example, how could organisms evolve to the point where they could reproduce *before* they could reproduce?

and killing genetically damaged cells.^e How could DNA have survived unless p53 and its many functions already existed?

In each human, tens of thousands of genes are damaged daily by radiation, toxins, strand breaks, etc.^f Also, when a cell divides, its DNA is sometimes copied with errors. Every organism has machinery that locates^g and repairs damaged and mistranslated DNA.^h Without such repair systems, the organism would quickly deteriorate and die. If evolution had happened, each organism would have become extinct before these complex DNA repair mechanisms could evolve.

In humans, 2000 genes are “indispensable for viability. They are required for basic cellular functions such as cell division, transcription, translation, DNA replication, cycle control, and fundamental metabolism.” After only 1999 of these essential genes had evolved, what would have happened? Extinction! Human evolution would have had to start all over again.ⁱ

37. Sexual Reproduction

If sexual reproduction in plants, animals, and humans is a result of evolutionary sequences, an unbelievable series of chance events must have occurred at each stage.

- The amazingly complex, radically different, yet complementary reproductive systems of the male and female must have **completely** and **independently** evolved at each stage about the **same time** and **place**. Just a slight incompleteness in only one of the two *at any stage* would make both reproductive systems useless, and the organism would become extinct.
- The physical, chemical, and emotional systems of the male and female would also need to be compatible.^a
- The millions of complex products of a male reproductive system (pollen or sperm) must have an affinity for and

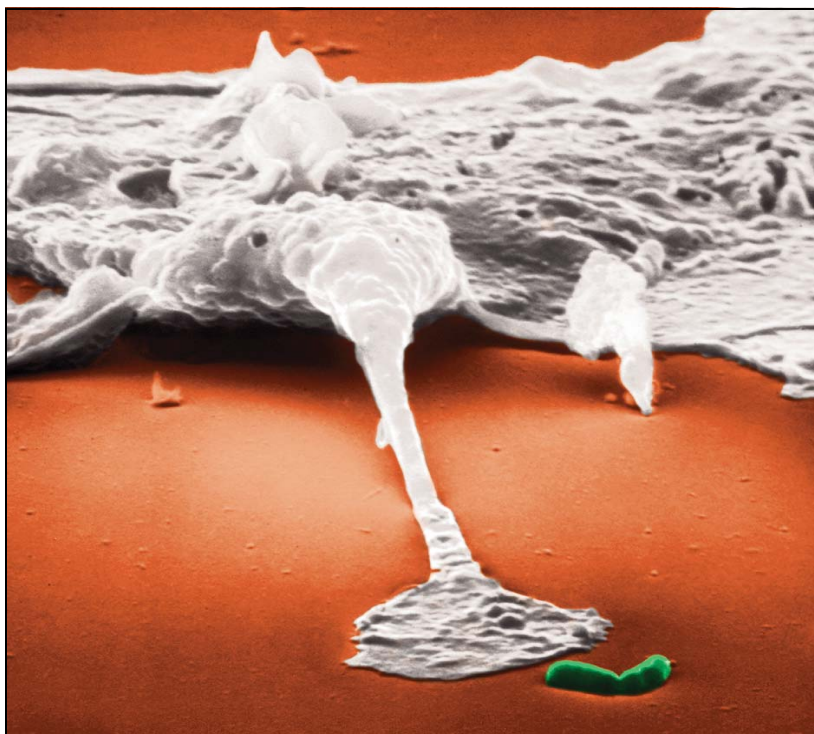

Figure 18: White Blood Cell. A white blood cell is stalking the green bacterium shown at the lower right. Your health, and that of many animals, depends on the effectiveness of these “search-and-destroy missions.” Consider the capabilities and associated equipment this white blood cell must have to do its job. It must identify friend and foe. Once a foe is detected, the white blood cell must rapidly locate and overtake the invader. Then, the white blood cell must engulf the bacterium, destroy it, and have the endurance to repeat this many times. Miniaturization, fuel efficiency, and compatibility with other parts of the body are also key requirements. The equipment for each function requires careful design. Unless all this worked well from the beginning of life, **a requirement that rules out evolution**, bacteria and other agents of disease would have won, and we would not be here to marvel at these hidden abilities in our bodies.

A few “stem cells” in your bone marrow produce more than 100 billion of these and other types of blood cells every day. Each white blood cell moves on its own at up to 30 microns (almost half the diameter of a human hair) each minute. So many white blood cells are in your body that their total distance traveled in one day would circle Earth twice. © Boehringer Ingelheim International GmbH; photo by Lennart Nilsson.

a mechanical, chemical,^b and electrical^c compatibility with the eggs of the female reproductive system.

- d. The many intricate processes occurring at the molecular level inside the fertilized egg would have to work with fantastic precision—processes that scientists can describe only in a general sense.^d
- e. The environment of this fertilized egg, from conception through adulthood and until it also reproduced with another sexually capable adult (who also “accidentally” evolved), would have to be tightly controlled.
- f. This remarkable string of “accidents” must have been repeated for millions of species.

Either this series of incredible and complementary events happened by random, evolutionary processes, or sexual reproduction was designed by intelligence.

Furthermore, if sexual reproduction evolved even once, the steps by which an embryo becomes either a male or female should be similar for all animals. Actually, these steps vary among animals.^e

Evolution theory predicts nature would select asexual instead of sexual reproduction.^f If asexual reproduction (splitting an organism into two identical organisms) evolved before sexual reproduction, how did complex sexual diversity arise—or survive?

If life evolved, why would any form of life live long beyond its reproductive age, when beneficial changes cannot be passed on? All the energy expended, supposedly over thousands of years and many evolutionary stages, to allow organisms to live beyond reproductive age would be a waste, until the evolutionary advantage had completely evolved.

For example, Why do human females live past menopause? If there is no potential for reproduction, then according to evolution, there is no evolutionary reason to exist.

Darwin’s statement on page 20, can be generalized by adding the words in brackets:

If it could be demonstrated that any complex organ [or capability] existed which could not possibly have been formed by numerous successive, slight modifications, [none of which is harmful] my theory would absolutely break down.

Finally, to produce the first life form would be one miracle. But for natural processes to produce life that could reproduce itself would be a miracle on top of a miracle.^g

▲ 38. Symbiotic Relationships

Different forms of life are completely dependent upon each other. At the broadest level, the animal kingdom depends on oxygen produced by the plant kingdom. Plants, in turn, depend on carbon dioxide produced by the animal kingdom.

More local and specific examples include fig trees and the fig gall wasp,^a the yucca plant and the yucca moth,^b many parasites and their hosts, and pollen-bearing plants and the honeybee. Even members of the honeybee family, consisting of the queen, workers, and drones, are interdependent. If one member of each interdependent group evolved first (such as the plant before the animal, or one member of the honeybee family before the others), it could not have survived. Because all members of the group



Figure 19: Arctic Tern Migration Routes and Cockpit. The Arctic Tern, a bird of average size, navigates across oceans, as shown above, with the skill normally associated with navigational equipment in modern intercontinental aircraft. A round trip for the tern might be 22,000 miles. The tern's "electronics" are highly miniaturized, extremely reliable, maintenance free, and easily reproduced. Furthermore, this remarkable bird needs no training. If the equipment in the lower picture could not have evolved, how could the tern's more amazing "equipment" have evolved?

Equally amazing is the monarch butterfly which flies thousands of miles from breeding grounds in Canada to wintering grounds in Mexico. In its pinhead-size brain, the butterfly processes information from its antennae and navigates using a magnetic compass and sunlight.

obviously have survived, they must have come into existence at essentially the same time. In other words, creation.

39. Immune Systems

How could immune systems of animals and plants have evolved? Each immune system can recognize invading bacteria, viruses, and toxins. Each system can quickly mobilize the best defenders to search out and destroy these invaders. Each system has a memory and learns from every attack.

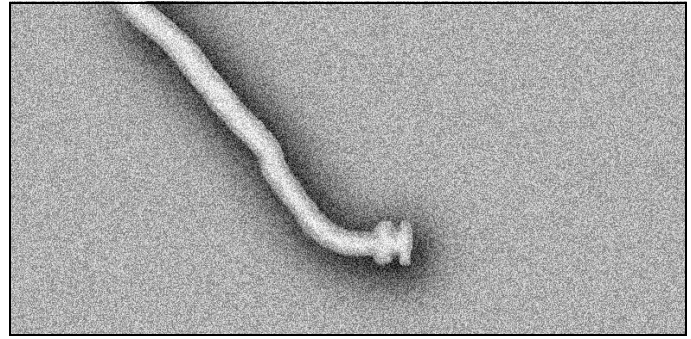

Figure 20: Bacterial Motor. Drawing based on a microphotograph of the flagellum of a salmonella bacterium.

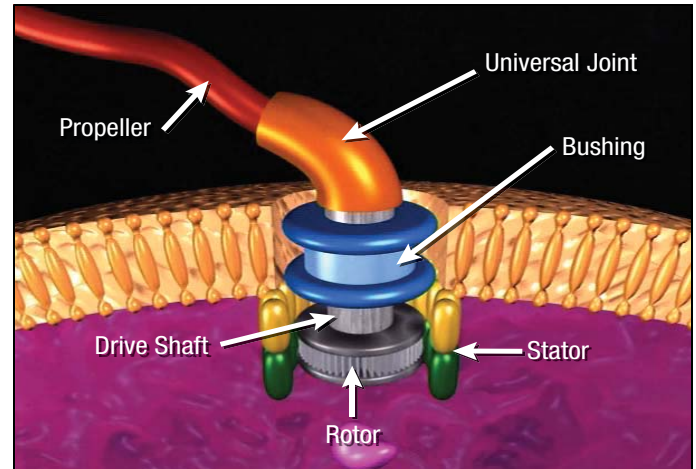

Figure 21: Illustration of a Bacterial Motor. Although no one completely understands how these tiny motors work, many studies have deduced the presence of the above intricate components.

If the many instructions that direct an animal's or plant's immune system had not been preprogrammed in the organism's genetic system when it first appeared on Earth, the first of thousands of potential infections would have killed the organism. This would have nullified any rare genetic improvements that might have accumulated. Simply stated, the large amount of genetic information governing the immune system could not have accumulated in a slow, evolutionary sense.^a Obviously, for each organism to have survived, all this information must have been there from the beginning. Again, creation.

40. Improbabilities

To claim that life evolved is to demand a miracle. The simplest conceivable form of single-celled life should have at least 600 different protein molecules. The mathematical probability that even one typical protein could form by chance arrangements of amino acid sequences is essentially zero^a—far less than 1 in 10^{450} . To appreciate the magnitude of 10^{450} , realize that the visible universe is about 10^{28} inches in diameter.

From another perspective, suppose we packed the entire

visible universe with a “simple” form of life, such as bacteria. Next, suppose we broke all their chemical bonds, mixed all their atoms, then let them form new links. If this were repeated a billion times a second for 20-billion years under the most favorable temperature and pressure conditions throughout the visible universe, would even one bacterium of any type reemerge? The chances^b are much less than one in $10^{99,999,999,873}$. Your chances of randomly drawing one preselected atom out of a universe packed with atoms are about one chance in 10^{112} —much better.

41. Living Technology

Most complex phenomena known to science are found in living systems—including those involving electrical, acoustical, mechanical, chemical, and optical phenomena. Detailed studies of various animals have also revealed certain physical equipment and capabilities that the world’s best designers, using the most sophisticated technologies, cannot duplicate. Examples of these designs include molecular-size motors in most living organisms;^a advanced technologies in cells;^b miniature and reliable sonar systems of dolphins, porpoises, and whales; frequency-modulated “radar” and discrimination systems of bats;^c efficient aerodynamic capabilities of hummingbirds; control systems, internal ballistics, and the combustion chambers of bombardier beetles;^d precise and redundant navigational systems of many birds, fish, and insects;^e and especially the self-repair capabilities of almost all forms of life. No component of these complex systems could have evolved without placing the organism at a selective disadvantage until the component’s evolution was complete. All evidence points to intelligent design.

Many bacteria, such as *Salmonella*, *Escherichia coli*, and some *Streptococci*, propel themselves with miniature motors at up to 15 body-lengths per second,^f equivalent to a car traveling 150 miles per hour—in a liquid. These extremely efficient, reversible motors rotate at up to 100,000 revolutions per minute.^g Each shaft rotates a bundle of whiplike flagella that acts as a propeller. The motors, having rotors and stators, are similar in many respects to electrical motors.^h However, their electrical charges come from a flow of protons, not electrons. The bacteria can stop, start, and change speed, direction, and even the “propeller’s” shape.ⁱ They also have intricate sensors, switches, control mechanisms, and a short-term memory. All this is highly miniaturized. **Eight million** of these bacterial motors would fit inside the circular cross section of a human hair.^j

Evolutionary theory teaches that bacteria were one of the first forms of life to evolve, and, therefore, they are simple. While bacteria are small, they are not simple. They can even communicate among themselves using chemicals.^k

Some plants have motors that are one-fifth the size of bacterial motors.^l Increasing worldwide interest in

nanotechnology is showing that living things are remarkably designed—beyond anything Darwin could have imagined.

42. The Validity of Thought

If life is the result of natural processes or chance, then so is thought. Your thoughts—including what you are thinking now—would ultimately be a consequence of a long series of irrational causes. Therefore, your thoughts would have no validity, including the thought that life is a result of chance or natural processes.^a By destroying the validity of ideas, evolution undercuts even the idea of evolution. “Science itself makes no sense if the scientific mind is itself no more than the product of irrational material forces.”^b

A related subject is the flexibility and redundancy of the human brain, which evolution or natural selection would not produce. For example, every year brain surgeons successfully remove up to half of a person’s brain. At times, the remaining half gradually takes over functions of the removed half. Also brain functions are often regained after portions of the brain are accidentally destroyed. Had humans evolved, such accidents would have been fatal before these amazing capabilities developed. Darwin was puzzled by the phenomenal capability of the brain.^c

Thoughts are not physical, although they use physical things, such as the brain, oxygen, electrons, and sensory inputs. The mind thinks, but the brain, like a powerful computer, can’t really “think.” Nor can any physical substance. Albert Einstein put his finger on this profound issue:

I am convinced that ... the concepts which arise in our thought and in our linguistic expressions are all—when viewed logically—the free creations of thought which cannot inductively be gained from sense experiences. ... we have the habit of combining certain concepts and conceptual relations (propositions) so definitely with certain sense experiences that we do not become conscious of the gulf—logically unbridgeable—which separates the world of sensory experiences from the world of concepts and propositions.^d

C. S. Lewis put it another way:

If minds are wholly dependent on brains, and brains on biochemistry, and biochemistry (in the long run) on the meaningless flux of the atoms, I cannot understand how the thought of those minds should have any more significance than the sound of the wind in the trees.^e

So Who or what provided humans (and to a much lesser extent, animals) with the ability and freedom to think? It certainly wasn’t dead matter, chance, evolution, or time.

Life Science Conclusions

When Darwin published *The Origin of Species* in 1859, the “evolutionary tree” had only a few gaps. Believers in his new theory thought that these gaps would be filled as scientific knowledge increased. Just the opposite has

Figure 22: Integration and Compatibility. An organ is a complex structure of different types of tissues and cells, all of which work together to perform one or more functions, such as seeing, hearing, digesting, or pumping. (Shown are a few of the amazing human organs: eye, ear, stomach, heart, skin, and brain.)

A system, such as the nervous system, circulatory system, skeletal system, or reproductive system, consists of related organs and other tissues and cells that have even broader functions. In a healthy body, all systems work properly. Life depends on a broad, compatible, and complex hierarchy: molecules→cells→tissues→organs→systems→body→other organisms→the environment.

All must be carefully balanced and integrated.

Arbitrarily changing one component at any level will often be harmful at that level and to the vertical hierarchy. For example, change one type of molecule throughout a category of cells, and a diseased body or damaged cells may result. Environmentalists and ecologists are aware of this critical balance (regarding, say, the spotted owl and the environment), but often they fail to ask, "Who or what created this balance?" Some fail to see the incredible complexity, integration, and systems engineering that extends throughout the universe—from carbon atoms to galaxies to physical laws.

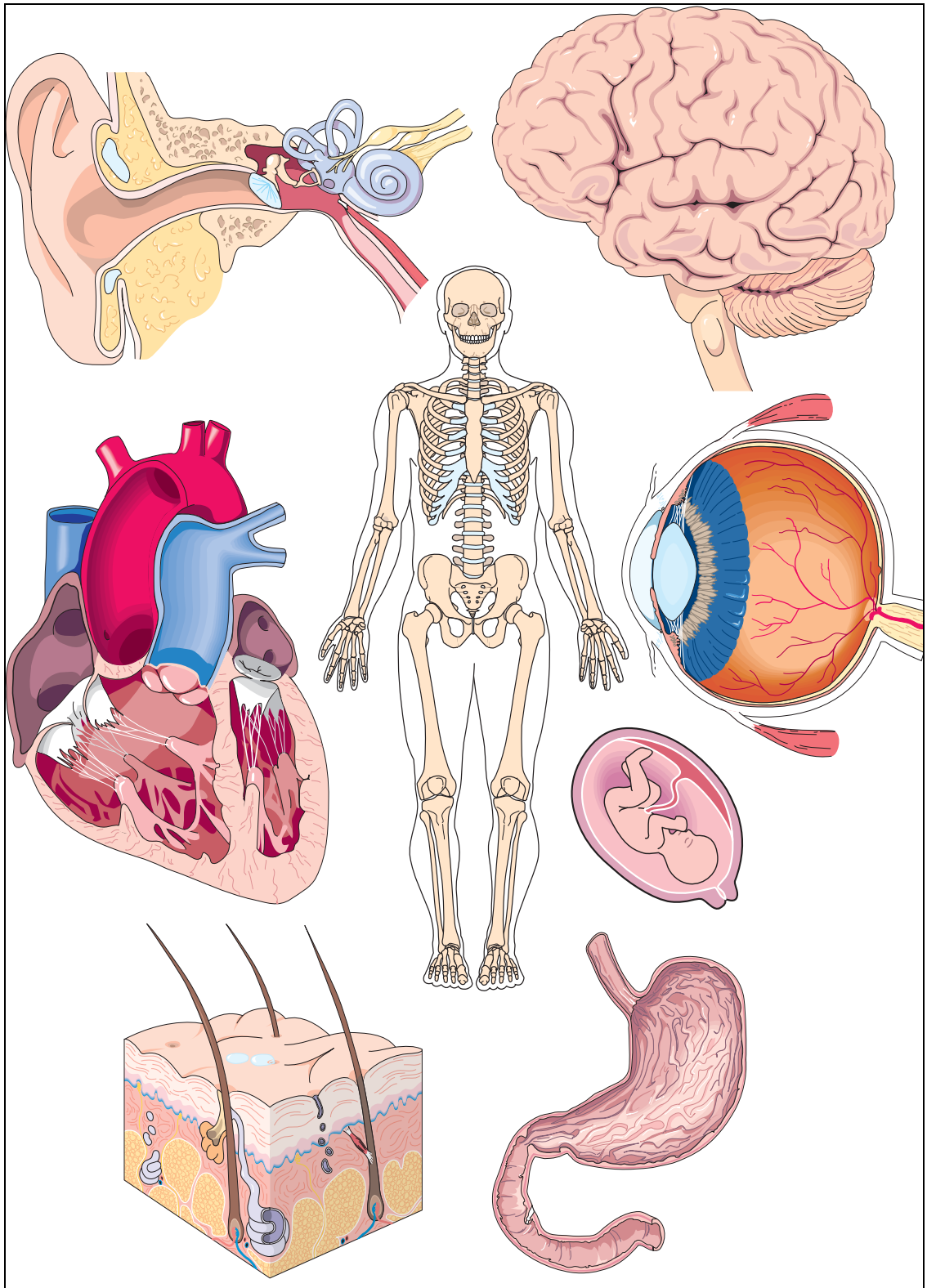

Humans are only one of millions of different types of organisms. To integrate all organisms into a living ecosystem requires stupendous design and balance. If evolution happened, time and natural processes alone must have maintained a livable environment for most forms of life as each new organism slowly came into existence and proliferated. No global contaminants, plagues, predators, or famines could be allowed for billions of years. Imagine what would happen if a few organisms at the base of the food chain became extinct.

Who or what has the ability to design, construct, and harmoniously integrate and maintain all of life? Time, chance, and natural processes, as evolution claims, or an infinitely intelligent Creator?

happened. As science has progressed, these “missing links” have multiplied enormously, and the obstacles to “bridging” these gaps have become even more obvious. For example, in Darwin’s day, all life fell into two categories (or kingdoms): animals and plants. Today, it is generally accepted that life falls into five radically different kingdoms, of which animals and plants comprise only two. (None of the five include viruses, which are complex and unique in their own way.) In the 1800s, the animal kingdom was divided into four animal phyla; today there are about forty.

Darwin suggested that the first living creature evolved in a “warm little pond.” Today, almost all evolutionary biologists will privately admit that science has no explanation for how the first living cell evolved. We now know that is a gigantic leap, vastly more improbable than for bacteria to evolve into humans. In Darwin’s day, a cell was thought to be about as simple as a ping-pong ball. Even today, many evolutionists say that bacteria are simple and one of the first forms of life to evolve. However, bacteria are marvelously integrated and complex manufacturing facilities with many mysteries yet to be understood, such as bacterial motors and communication among bacteria. Furthermore, cells come in two radically different types—those with a nucleus and those without. The evolutionary leap from one to the other is staggering to imagine.

The more evolutionists learn about life, the greater complexity they find. A century ago there were no sophisticated microscopes. Consequently, gigantic leaps from single-to multiple-cell organisms were grossly underestimated. Each type of cell in a multicellular organism has a unique job that is controlled by only part of the organism’s DNA. If that organism evolved, its delicate controls (directing which of the many DNA instructions to follow, which to ignore, and when) must also have evolved. Had it not evolved perfectly the first time, that organism would have been diseased. If that first unique cell could not reproduce, the new function would disappear. If just one reproducing cell is out of control, the organism would have one type of cancer.

Development of the computer has also given us a better appreciation of the brain’s intricate electronics, extreme miniaturization, and vast storage capabilities. The human eye, which Darwin admitted made him shudder, was only a single jump in complexity. [See Endnote 9b on [page 57](#).] We now know there are at least a dozen radically different kinds of eyes, each requiring similar jumps if evolution happened. Likewise, the literal leap we call “flight” must have evolved not once, but on at least four different occasions: for birds, some insects, mammals (bats), and reptiles (pterosaurs). Fireflies produce light without heat, a phenomenon called *bioluminescence*. Other species, including certain fish, crustaceans, squids, plants, bacteria, and fungi, also have lighting systems. Did all these remarkable capabilities evolve independently?

Before 1977, it was thought that sunlight provided the energy for all life. We now know that some organisms, living at

widely separated locations on the dark ocean floor, use only chemical and thermal energy. For one energy-conversion system to evolve into another would be like changing, by thousands of rare accidents, the wood-burning heating systems of widely separated homes to electricity—but slowly, one accident each year. The occupants would risk freezing every winter. How such a system could evolve on different ocean floors, without solar energy, and in a cold, diluting environment, has yet to be explained.

If evolution happened, many other giant leaps must also have occurred: the first photosynthesis, cold-blooded to warm-blooded animals, floating marine plants to vascular plants, placental mammals to marsupials, egg-laying animals to animals that bear live young, insect metamorphosis, the transition of mammals to the sea (whales, dolphins, porpoises, seals, sea lions, and manatees), the transition of reptiles to the sea (plesiosaurs, ichthyosaurs), and on and on.

Gaps in the fossil record are well known. A century ago, evolutionists argued that these gaps would be filled as knowledge increased. The same gaps persist, and most paleontologists now admit that those predictions failed. Of course, the most famous “missing link” is between man and apes, but the term is deceiving. There is not merely one missing link, but thousands—a long chain—if the evolutionary tree were to connect man and apes (with their many linguistic, social, mental, and physical differences).

Scientific advancements have shown that evolution is an even more absurd theory than it seemed in Darwin’s day. *It is a theory without a mechanism.* Not even appeals to long periods of time will allow simple organisms to “jump gaps” and become more complex and viable. In fact, as the next section (Astronomical and physical Sciences) will show, long periods of time make such leaps even less likely. Later in this book, you will see that those unimaginably long, time periods in which evolution is claimed to have occurred were a result of a scientific blunder—failure to understand the origin of Earth’s radioactivity.

Breeding experiments that many had hoped would demonstrate macroevolution have failed. The arguments used by Darwin and his followers are now discredited or, at best, in dispute, even among evolutionists. Finally, research during the last several decades has shown that the requirements for life are incredibly complex. Just the design that most people can see around them obviously implies a designer. Oddly enough, evolutionists still argue against this design by using arguments which they spent a great deal of time designing. *The theory of organic evolution is invalid.* As we leave the life sciences and examine the astronomical and physical sciences, we will see many other serious problems with evolutionary theories. If just one of the following could not have evolved: (1) the Earth, (2) the solar system, (3) our galaxy, (4) the universe, or even (5) the heavier chemical elements, as now seems to be the case for each of the five, then organic evolution could not even have begun.

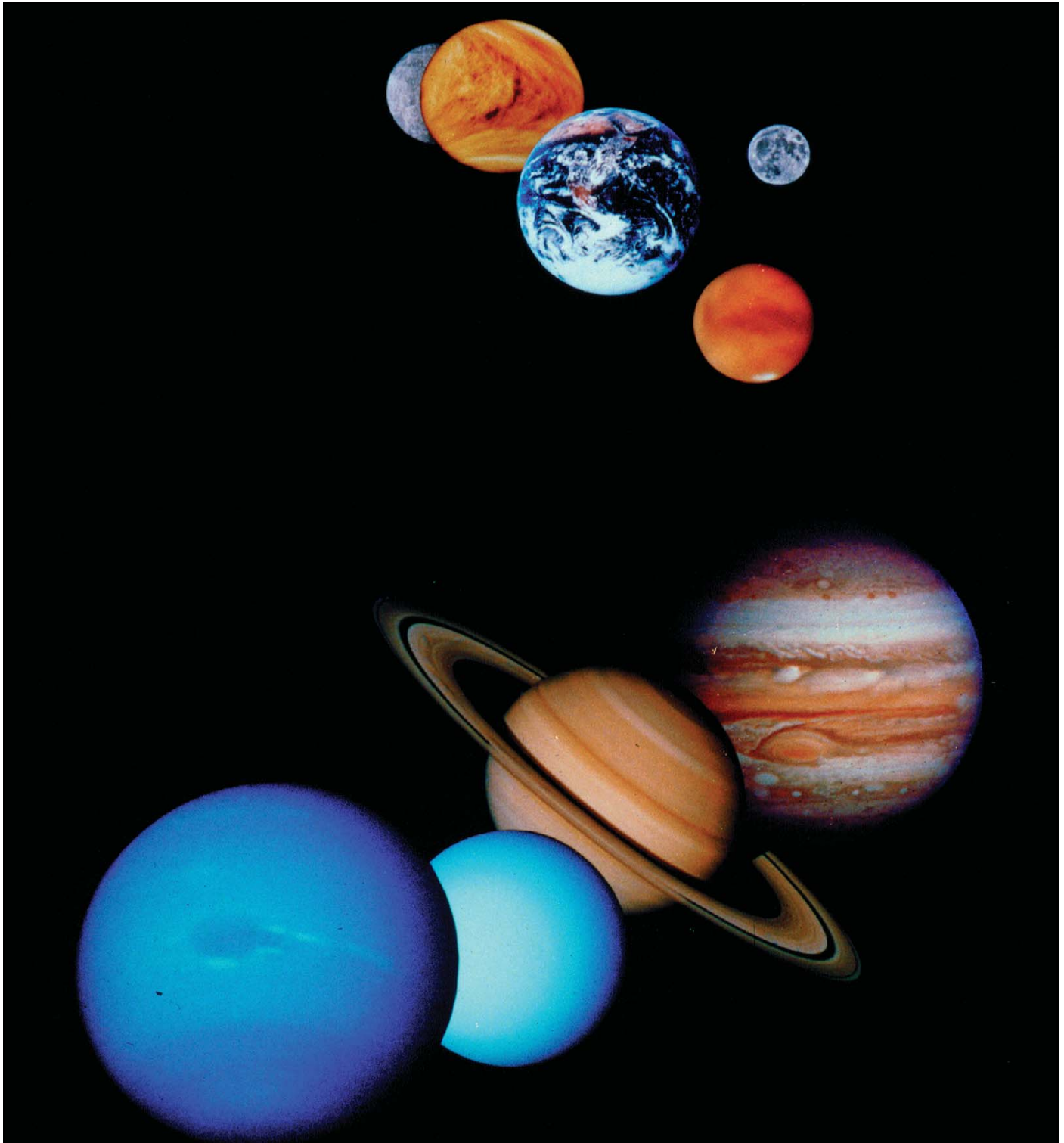

Figure 23: Unique Planets. This is a composite photograph (not to scale) of all planets in the solar system, except Pluto. They are, from top to bottom: Mercury, Venus, Earth (with the Moon to the right), Mars, Jupiter, Saturn, Uranus, and Neptune. The photos were taken by Mariner 10 (Mercury), Pioneer Venus Orbiter (Venus), Apollo 17 astronauts (Earth), Earth-based telescopes (Moon and Mars), and the two Voyager spacecraft (the four giant planets).

Each planet is unique. Similarities that would be expected if the planets had evolved from the same swirling dust cloud are seldom found. Yet, most planetary studies begin by assuming the planets evolved and are therefore similar. Typical arguments are as follows: “By studying the magnetic field (or any other feature) of Planet X, we will better understand how Earth’s magnetic field evolved.” Actually, each magnetic field is surprisingly different. “By studying Earth’s sister planet, Venus, we will see how plate tectonics shaped its surface and better understand how plate tectonics works on Earth.” It is now recognized that plate tectonics does not occur on Venus. (Part II of this book will show that the plate tectonic theory is incorrect.) [See also **“Does Recently Declassified Data Falsify Plate Tectonic Theory?”** on page 500.]

Astronomical and Physical Sciences

The Universe, Solar System, Earth, and Life Were Recently Created.

Theories for the Evolution of the Solar System and Universe Are Unscientific and Hopelessly Inadequate.

43. Strange Planets

Many undisputed observations contradict current theories on how the solar system evolved.^a One theory says that planets formed when a star, passing near our Sun, tore matter from the Sun. More popular theories hold that the solar system formed from a cloud of swirling gas, dust, or larger particles. If the planets and their known moons evolved from the same material, they should have many similarities. After several decades of planetary exploration, this expectation is now recognized as false.^b [See [Figure 23](#).] According to these evolutionary theories:

Backward-Spinning Planets. All planets in our solar system should spin in the same direction, but Venus,^c Uranus,^c and Pluto rotate backwards.^d [See [“Is Pluto a Planet?”](#) on page 28.]

Backward Orbits. If planets and moons evolved from swirling dust clouds as is commonly taught, each of the almost 200 known moons in the solar system should orbit its planet in the same direction as the planet spins, but more than 30 moons have backward orbits.^e Furthermore, Jupiter, Saturn, Uranus, and Neptune have moons orbiting in both directions.

Tipped Orbits.

- ◆ **Moons.** The orbit of each of these moons should lie very near the equatorial plane of the planet it orbits, but many, including Earth’s moon, are in highly inclined orbits.^f
- ◆ **Planets.** The orbital planes of the planets should lie in the equatorial plane of the Sun. Instead, the orbital planes of the planets typically deviate from the Sun’s



Figure 24: Saturn and Six of Its Moons. Saturn has 62 known moons. One of them, named Phoebe, is dominated by water,^g and its orbit is almost perpendicular to Saturn’s equator. Why? As explained in [“Earth: The Water Planet”](#) (Category 44 below), it is difficult enough for evolutionist astronomers to explain why Earth has so much water. So why would tiny Phoebe be a water-rich rock? Pages 337–377 will explain why that rock and its water were once on Earth. (But, don’t skip pages 108–151.)

equatorial plane by 7 degrees, a significant amount.

Angular Momentum. The Sun should have about 700 times more angular momentum than all its planets combined. Instead, the planets have 50 times more angular momentum than the Sun.^h

44. Earth: The Water Planet

The amount of water on Earth greatly exceeds that known to be on or within any other planet in the solar system. Liquid water, which is essential for life, has unique

Is Pluto a Planet?

In 2006, after years of internal disagreement, 4% of the members of the International Astronomical Union (IAU)—those meeting in Prague—voted to no longer call Pluto a planet. Instead, they said Pluto is a *trans-Neptunian object* (TNO). Far more astronomers and planetary scientists quickly signed a petition opposing the IAU's vote. [See Endnote 43i on page 86.]

The IAU had no jurisdiction to change the definition of “planet” for the rest of the world. It is fine for an organization to tell others what it considers a word to mean, but common usage is the basis for definitions. Our language is filled with scientific words whose meanings have changed based on new discoveries and broader understandings. Few meanings have changed based on an organization's vote.

Since Pluto's discovery 76 years earlier, it has been a thorn in the side of astronomers trying to explain how planets evolve, because so many characteristics of Pluto do not fit evolutionary scenarios. No longer calling Pluto a planet (although it is spherical, has five known moons and a thick atmosphere, and orbits the Sun in the right direction) may reduce those man-made problems, but it now calls attention to the more difficult question of how thousands of trans-Neptunian objects evolved.

In 1930, after astronomers had been searching for a suspected ninth planet for 25 years, a tenacious farm boy from Kansas, Clyde W. Tombaugh (1906–1997), discovered Pluto at Lowell Observatory in Flagstaff, Arizona. He later became one of my favorite professors. Going to his backyard to use his 9-inch handmade telescope was memorable. Professor Tombaugh was a warm, unpretentious man with the biggest smile you have ever seen. However, in class, he sometimes became irate at astronomers who made pronouncements but seldom touched a telescope.

Classification can be a useful tool, but at other times it leads to endless arguments, because the world (or, in this case, the solar system) is usually more complicated than theories imply. We can call Pluto anything we wish, but tens of thousands of books and hundreds of millions of students have called Pluto a planet.

What is a planet? Its original meaning was “wandering star.” I will always associate Pluto with Clyde Tombaugh and the worldwide excitement of finally discovering the ninth *planet*. For historical reasons, if nothing else, I suspect that millions of others will continue to call Pluto a planet as well as a trans-Neptunian object.

Semantics aside, the scientific question remains: how could Pluto, the largest TNO known, form? Indeed, how did all TNOs form? Later in this book, you will see.

and amazing properties; it covers 70% of Earth's surface. *Where did all Earth's water come from?*

If the Earth and solar system evolved from a swirling cloud of dust and gas, almost no water should reside near Earth—or within 5 astronomical units (AU) from the Sun. (1 AU is the average Earth–Sun distance.) Any water (liquid or ice) that close to the Sun would vaporize and be blown by the solar wind to the outer reaches of the solar system,^a as we see happening with water vapor in the tails of comets.

Had comets, asteroids, or meteorites delivered Earth's water, the energy of such impacting bodies would have vaporized the transported water, leading to a runaway greenhouse on Earth, that would have made life on Earth permanently impossible. Although comets contain considerable water,^b comets did not provide much of Earth's water, because comet water contains too much heavy hydrogen, relatively rare in Earth's oceans. Comets also contain too much argon. If comets provided even just 1% of Earth's water, our atmosphere should have much more argon than it does.^c Meteorites that contain water also have too much heavy hydrogen.^d [Pages 301–374 explain why comets, asteroids, and some types of meteorites contain so much water *and heavy hydrogen*. Pages 379–433 explain why comets have so much argon. Heavy hydrogen is described on page 311.]

These observations cause some to conclude that water was transported from the outer solar system to Earth by objects that no longer exist. If so, many of these “water tankers” should have also collided with the other inner planets (Mercury, Venus, and Mars) as well. Actually, their water characteristics are not like those of Earth.^e Instead of imagining “water tankers” that conveniently disappeared, perhaps we should ask if the Earth was created with its water already present.

45. Molten Earth?

For more than two centuries, textbooks have taught in various ways that the early Earth was molten for 500,000,000 years, because it formed by meteoritic bombardment.^a If so, the heat released by impacts would have melted the entire Earth many times over.^b Had Earth ever been molten, its dense, nonreactive chemical elements, such as gold, would have sunk to Earth's core. Gold is 70% denser than lead, yet it is found at the Earth's surface.^c

Even granite, the basic continental rock, is a mixture of many minerals, each with a different density. If melted granite slowly cooled, the first mineral to solidify would sink to the bottom of the melt, if it were denser than the melt, or it would float to the top of the melt, if it were less dense than the melt. A “layer cake” of minerals, would form instead of granite—which is a granular mixture of minerals. Therefore, the entire Earth was never molten and did not form by meteoritic bombardment.

Radioactive dating of certain zircon minerals also

contradicts a molten Earth. Trace elements within those zircons show that the zircons formed at a temperature less than 212°F.^d However, based on radioactive dating, those zircons formed billions of years ago when, according to evolutionists, the Earth should have been molten (exceeding 1,800°F)—an obvious contradiction. Either the molten Earth belief or the radioactive dating method must be wrong. Perhaps both are wrong.

Meteorites contain much more of the element xenon than Earth's surface rocks, relative to other noble (inert) gases, such as helium, neon, and argon. Had Earth formed by meteoritic bombardment, Earth's surface rocks would have a different composition, and our atmosphere would contain up to ten times more xenon than it has.^e If Earth did not evolve by meteoritic bombardment, it may have begun as one large body. [See “**Melting the Inner Earth**” on pages 603–606.]

A fatal problem with the molten Earth idea will be explained after the properties of magma are explained on page 156. After the mantle solidified, the Earth would be quite different than it is today.

46. Evolving Planets?

Contrary to popular opinion, planets should not form from just the mutual gravitational attraction of particles orbiting a star, such as our Sun. Orbiting particles should spiral into their star or be scattered or expelled from their orbit—not merge (accrete) to become a planet.^a Experiments have shown that colliding particles, instead of sticking together, almost always fragment.^b (Similar difficulties exist in trying to form a moon from particles orbiting a planet.)

Despite these problems, let us assume that pebble-size to moon-size particles somehow evolved. “Growing a planet” by many small collisions will produce an almost *nonspinning* planet, because spins imparted by impacts will be largely self-canceling.^c

The growth of a large, gaseous planet (such as Jupiter, Saturn, Uranus, or Neptune) far from the central star is especially difficult for evolutionist astronomers to explain for several reasons.^d

- Gases dissipate rapidly in the vacuum of outer space, especially the lightest two gases—hydrogen and helium, which comprise most of the mass of the giant planets.
- Because gas molecules orbiting a star do not gravitationally pull in (or merge with) other gas molecules in the orbiting ring, a rocky planet, about ten or more times larger than Earth, must first form to attract all the gas gravitationally. This must happen very quickly, before the gas dissipates.^e (Jupiter's hydrogen and helium are 300 times more massive than the entire Earth.)
- Stars like our Sun—even those which evolutionists say are young—do not have enough orbiting hydrogen or helium to form one Jupiter.^f

Computer simulations show that Uranus and Neptune could not have evolved anywhere near their present distance from the Sun.^g Planets found outside our solar system also contradict the theories for how planets supposedly evolve. [See “**Have Planets Been Discovered Outside the Solar System?**” on page 513.]

Based on demonstrable science, gaseous planets and the rest of the solar system did not evolve.

47. Planetary Rings

Planetary rings have long been associated with claims that planets evolved. Supposedly, after planets formed from a swirling dust cloud, rings remained, as seen around the giant planets: Saturn, Uranus, Jupiter, and Neptune.^a [See Figure 25.] Therefore, some believe that because we see rings, planets must have evolved.^b

Actually, planetary rings do not relate to a planet's origin. They form when a planet's gravity captures material from a passing asteroid or material expelled from a nearby moon—by a volcano, a geyser, tidal effects, or the impact of a comet or meteorite.^c Debris that escapes a moon or asteroid because of its weak gravity and the giant planet's gigantic gravity then orbits that planet as a ring. Ring material, called ring rain, is seen falling onto Saturn's surface at a rapid rate, showing that Saturn's rings are young. They they will be gone in less than 10,000 years.^d (The Chapter that begins on page 337 explains why asteroids delivered ring material to the giant planets soon after the flood.) Because a planet's gravity pulls escaped particles away from its moons, particles orbiting a planet could never form moons—as evolutionists assert.

48. Origin of the Moon

Evolutionary theories for the origin of the Moon are highly speculative and completely inadequate.^a The Moon could not have spun off Earth, because its orbital plane is too highly inclined. The Moon's nearly circular orbit shows that it was never torn from nor captured by Earth.^b If the Moon formed from particles orbiting Earth, other particles should be easily visible inside the Moon's orbit; none are.

The once popular theory that the Moon formed from debris splashed from Earth by a Mars-size impactor is now largely rejected, because the rocks that astronauts brought back from the moon are too similar to those of Earth.^c The impactor's material should have been quite different.^d (In Part II of this book, you will see why the loose rocks the astronauts brought back from the moon are so similar to Earth's rocks. *Those rocks came from Earth.*) Had a Mars-size impact occurred, many small moons should have formed.^e Also, the impactor's glancing blow would either be too slight to form our large Moon, or so violent that Earth would end up spinning too fast.^f Besides, part of Earth's surface and mantle would have melted, but none of the

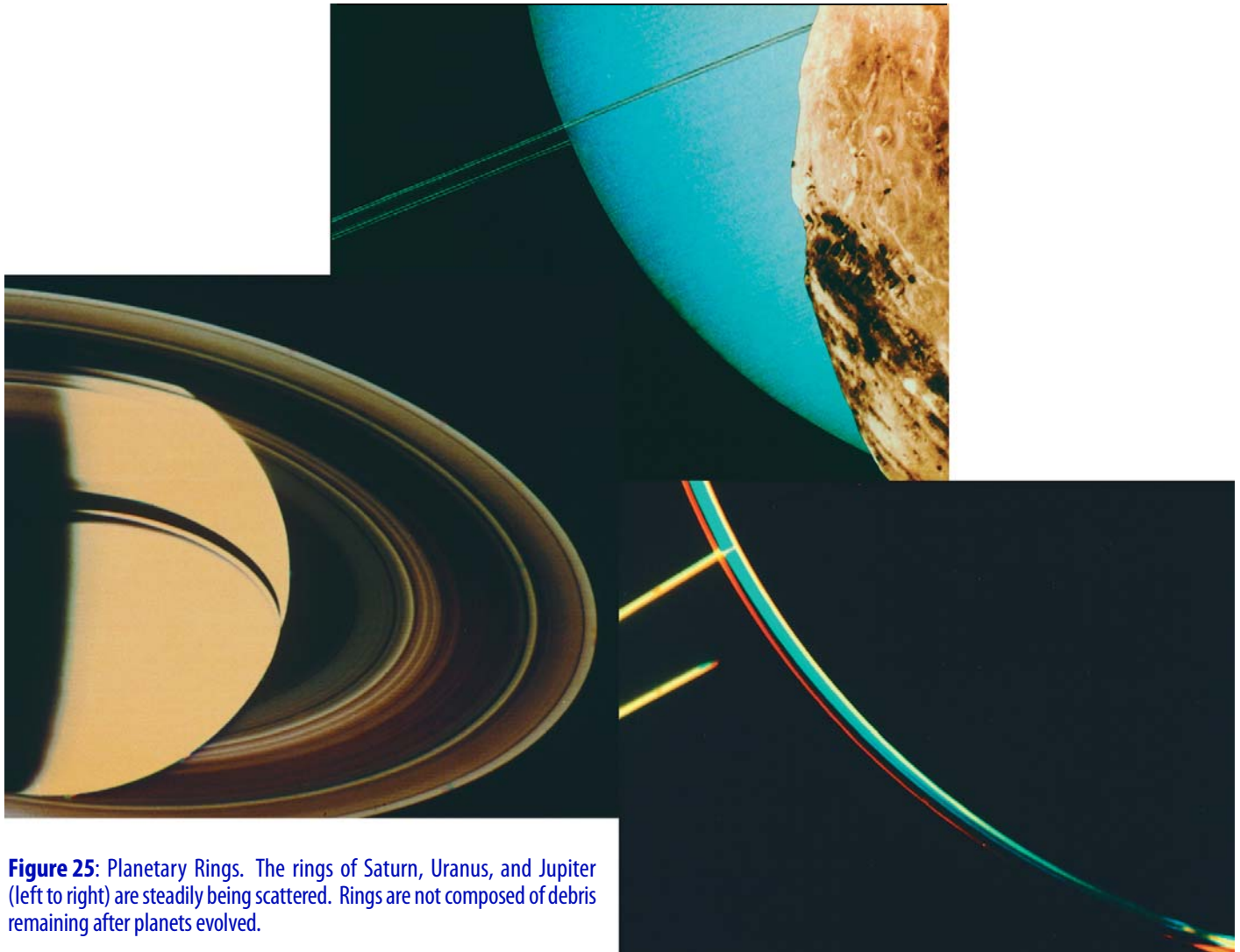

Figure 25: Planetary Rings. The rings of Saturn, Uranus, and Jupiter (left to right) are steadily being scattered. Rings are not composed of debris remaining after planets evolved.

indicators of that melting have been found.⁸ Small particles splashed from Earth would have completely melted, allowing any water inside them to escape into the vacuum of space. However, Apollo astronauts found on the Moon tiny glass beads that had erupted as molten material from inside the Moon but had dissolved water inside! The total amount of water that was once inside the Moon probably equaled that in the Caribbean Sea.^h Finally, a Mars-size impactor would heat up and evaporate much, if not all, of Earth's surface water. Earth would likely have experienced a runaway greenhouse effect, making Earth permanently uninhabitable. [Page 609 explains aspects of this problem.]

These explanations have many other problems. Understanding them caused one expert to joke, “The best explanation [for the Moon] was observational error—the Moon does not exist.”ⁱ Similar difficulties exist for evolutionary explanations of the other (almost 200) known moons in the solar system.

But the Moon does exist. If it was not pulled or splashed from Earth, was not built up from smaller particles near its present orbit, and was not captured from outside its present orbit, only one hypothesis remains: the Moon

was created in its present orbit. [See “Evolving Planets?” on page 29, and on pages 41–42, “Moon Dust and Debris,” “Moon Recession, and “Hot Moon.”]

49. Evolution of the Solar System?

Evolutionists claim that the solar system condensed out of a vast cloud of swirling dust about 4.6-billion years ago. If so, many particles that were not swept up as part of a planet should now be spiraling in toward the Sun. Colliding asteroids also would create dust particles that, over millions of years, would spiral in toward the Sun. (To understand why, see “Poynting-Robertson Effect” page 42.) Particles should still be falling into the Sun's upper atmosphere, burning up, and giving off an easily measured infrared glow. Measurements taken during the solar eclipse of 11 July 1991 showed no such glow.^a So, the assumed “millions of years” and this explanation for the solar system's origin are probably wrong.

Disks of gas and dust surround some stars. That does not mean planets are forming in those disks. Some disks formed from matter suddenly expelled from the star.^b Other disks

formed from impact debris or other matter near the star. Early astronomers called the disks *planetary nebulae*, because they mistakenly thought they contained evolving planets.^c

50. Faint Young Sun

If, as evolutionists teach, the solar system evolved from a spinning cloud of dust and gas 4.6-billion years ago, the slowly condensing Sun would have radiated 25–30% less heat during its first 600-million years than it radiates today.^a (A drop in the Sun's radiation of *only a few percent* would freeze all our oceans.) Had this happened anytime in the past, let alone for 600-million years, the ice's mirrorlike surfaces would have reflected more of the Sun's radiation into outer space, cooling Earth even more in a permanent, runaway deep-freeze. If it had, all agree that life could not have evolved.

Evolutionists first tried to solve this “faint young Sun” problem by assuming Earth's atmosphere once had up to a thousand times more heat-trapping carbon dioxide than today. No evidence supports this, and much opposes it.^b Actually, large amounts of carbon dioxide on a cool Earth would have produced “carbon dioxide ice clouds high in the atmosphere, reflecting the Sun's radiation into outer space and locking Earth into a permanent ice age.”^c

A second approach assumes that Earth's atmosphere had a thousand times more ammonia and methane, other heat-trapping gases. Unfortunately, sunlight quickly destroys both gases, and at high concentrations methane produces a haze that would have cooled Earth's surface instead of warming it.^d Besides, ammonia would readily dissolve in water, making oceans toxic.^e

A third approach assumes that Earth had no continents, had much more carbon dioxide in its atmosphere, and rotated once every 14 hours, so most clouds were concentrated at the equator. With liquid water covering the entire Earth, more of the Sun's radiation would be absorbed, raising Earth's temperature slightly. All three assumptions are questionable.^f

Evolutionists have never explained in any of these approaches how such drastic changes could occur in almost perfect step with the slow increase in the Sun's radiation. Until some evidence supports such “special pleadings,” it does not appear that the Sun evolved.^g

If the Sun, a typical and well-studied star, did not evolve, then why presume that all other stars did?

51. Mountains of Venus

Venus must have a strong crust to support its high, dense^a mountains. One mountain, Maat Mons, rises higher than Earth's Mount Everest does above sea level. Because Venus

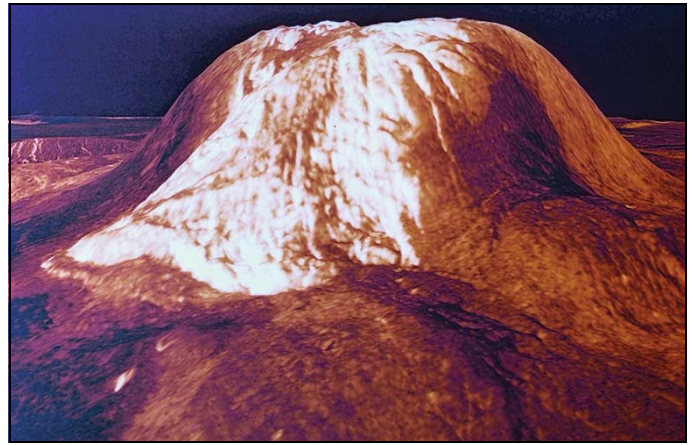

Figure 26: Maat Mons on Venus. If Venus' mountains were composed of lighter material, they would “float” in the denser rock below, similar to an iceberg floating in denser liquid water. (Mountains on Earth are buoyed up, because they have a density of about 2.7 gm/cm³ and “float” in rock that is about 3.3 gm/cm³.) Data from the Magellan spacecraft that orbited and mapped Venus for several years showed that Venus' mountains are composed of rock that is too dense to “float.” So, what supports them? It must be Venus' strong crust—despite Venus' extremely hot atmosphere. This implies Venus is not old and did not evolve.

is relatively near the Sun, its atmosphere is 860°F—so hot its *surface* rocks must be weak or “tarlike.” (Lead melts at 622°F and zinc at 787°F.) Only if Venus' *subsurface* rocks are cold and strong can its mountains defy gravity. This allows us to draw two conclusions, both of which contradict major evolutionary assumptions.

First, evolutionists assume that planets grew (evolved) by rocky debris falling in from outer space, a process called *gravitational accretion*. Heat generated by a planet's worth of impacts would have left the rocky planets molten. However, Venus was never molten. Had it been, its hot atmosphere—a runaway greenhouse composed of supercritical carbon dioxide—would have prevented its subsurface rocks from cooling enough to support its mountains. So, Venus did not evolve by gravitational accretion.

Secondly, evolutionists believe that the entire solar system is billions of years old. If Venus were billions of years old, its atmospheric heat would have “soaked” deeply enough into the planet to weaken its subsurface rocks. If so, not only could Venus' crust not support mountains, the hot mountains themselves could not maintain their steep slopes. Venus must be relatively young.

52. Space, Time, and Matter

No scientific theory exists to explain the origin of space, time, or matter. Because each is intimately related to or even defined in terms of the others, a satisfactory explanation for the origin of one must also explain the origin of the others.^a

53. A Beginning

Heat always flows from a hot body to a cold body. If the universe were infinitely old, everything would have the same temperature. Because temperatures vary, the universe is not infinitely old. Therefore, the universe had a beginning. (A beginning suggests a Creator.)^a

54. First Law of Thermodynamics

The first law of thermodynamics tells us that the total energy in the universe, or in any isolated part of it, remains constant. In other words, energy (or its mass equivalent) is not now being created or destroyed; it simply changes form. Countless experiments have verified this.

A corollary of the first law is that natural processes cannot create energy. Therefore, energy must have been created in the past by some agency or power outside and independent of the natural universe. Furthermore, if natural processes cannot produce mass and energy (the inorganic portion of the universe) then it is even less likely that natural processes can produce the much more complex organic (or living) portion of the universe.

55. Second Law of Thermodynamics

The universe is an isolated system, so according to the second law of thermodynamics, the energy in the universe available for useful work has always been decreasing. Therefore, the universe is not infinitely old—it had a beginning. Also, as one goes back in time, the energy available for work would eventually exceed the total energy in the universe, which, according to the first law of thermodynamics, remains constant. This is an impossible condition, showing in another way that the universe had a beginning.^a

A further consequence of the second law is that soon after the universe began, it was more organized and complex than it is today—not in a highly disorganized and random state as assumed by evolutionists and proponents of the big bang theory.^b

56. Big Bang?

The big bang theory, now known to be seriously flawed,^a was based on three observations: the redshift of light from distant stars, the cosmic microwave background (CMB) radiation, and the amount of helium in the universe. All three, if correctly understood, contradict the big bang theory.

Redshift. The redshift of starlight is a Doppler effect,^b that is, stars and galaxies are moving away from Earth, stretching out (or reddening) the wavelengths of light they emit. Because the more distant stars and galaxies have a greater redshift, the space between these bodies is increasing—a

fact so consistently observed that it is called “Hubble’s Law,” after Edwin Hubble who discovered it in 1929.

Space itself has expanded—so the total potential energy of stars, galaxies, and other matter has increased with no corresponding loss of energy elsewhere.^c These galaxies, in their recession from us, should be decelerating, but to the surprise of everyone, measurements showed the opposite; galaxies are accelerating. Thus, the big bang violates the law of conservation of energy, probably the most important of all physical laws. [See “**Dark Thoughts**” on page 33.]

Many objects with high redshifts seem connected, or associated, with objects having low redshifts. They could not be traveling at such different velocities and stay connected for long. [See “**Connected Galaxies**” and “**Galaxy Clusters**” on page 43.] For example, many quasars have very high redshifts, and yet they statistically cluster with galaxies having low redshifts.^d Some quasars seem to be connected to galaxies by threads of gas.^e Many quasar redshifts are so great that the massive quasars would need to have formed too soon after the big bang—a contradiction of the theory.^f

Finally, redshifted light from galaxies has some strange features inconsistent with the Doppler effect. Because redshifts are caused by the motion of objects moving away from Earth, one would expect redshifts to have continuous values. Instead, redshifts cluster at specific, evenly-spaced values.^g It is as strange as seeing all cars on a highway traveling at an odd number of miles per hour, and nothing in between. Much remains to be learned about redshifts.

CMB. All matter radiates heat, regardless of its temperature. Astronomers can detect an extremely uniform radiation, called *cosmic microwave background (CMB) radiation*, coming from all directions. It appears to come from perfectly radiating matter whose temperature is 2.73 K—nearly absolute zero. Many incorrectly believe that the big bang theory predicted this radiation.^h

Matter in the universe is highly concentrated into galaxies, galaxy clusters, and superclusters—as far as the most powerful telescopes can see.ⁱ Because the CMB is so uniform, many thought it came from evenly spread matter soon after a big bang. But such uniformly distributed matter would hardly gravitate in any direction. Even after tens of billions of years, 1–3 trillion visible galaxies and much larger structures would not evolve. Simply stated, the big bang did not produce the CMB.^j [See pages 460–461.]

Helium. Contrary to what is commonly taught, the big bang theory does not explain the amount of helium in the universe; the theory was adjusted to fit the amount of helium.^k Ironically, the lack of helium in certain types of stars (B type stars)^l and the presence of beryllium and boron in “older” stars^m contradict the big bang theory.

A big bang would produce only hydrogen, helium, and a trace of lithium, so the first generation of stars to

Dark Thoughts

Missing Mass. Between 1969 and 1998, virtually all big bang theorists said that the rapidly expanding universe must have enough mass to prevent all matter from flying apart; otherwise, matter would not have come together to form stars and galaxies. Estimates of the universe's actual mass was always 10–20% of the needed amount. They reasoned that since the big bang theory was correct, the missing mass had to exist.^u

Dark Matter. One would expect that the rotational velocities of stars around the center of a spiral galaxy would decrease the farther a star is from that center. However, since 1933, it has been known that those velocities are roughly constant beyond the galaxy's central bulge. (This discovery gives great insight into how and when the universe began, but contradicts the way big bang advocates think galaxies formed.) To explain these almost constant velocities, those advocates have told us since 1975 that (1) an invisible form of matter, called “dark matter,” must surround and permeate galaxies, and (2) five times more dark matter than normal matter should even be in the room where you are sitting. No direct measurements show that dark matter exists.^v

Dark Energy. Big bang theorists have struck again by devising something new and imaginary to prop up their theory. Prior to 1998, the big bang theory predicted that the universe's expansion must be slowing, just as a ball thrown upward must slow as it moves away from Earth. For decades, cosmologists tried to measure this deceleration. Then in 1998, a shocking discovery was made and confirmed. The universe's expansion is not decelerating; it is accelerating!^a Therefore, to protect the big bang theory, something again had to be invented. Some energy source that overpowers gravity must continually accelerate stars and galaxies away from each other. That energy, naturally enough, is called *dark energy*. Again, an important discovery that gives insight into how the universe actually began was effectively lost by a faulty explanation: dark energy.

“Dark matter” was concocted to make spiral galaxies spin correctly after a big bang. “Missing mass” was created to hold the universe together, and “dark energy” was created to push (actually accelerate) the universe apart. None of these have been seen or measured,^v even with the world's best telescopes and most sophisticated experiments. However, we are told that 95% of the universe is invisible—either dark matter (25%) or dark energy (70%). As

somehow form after a big bang should consist only of those elements. Some of these stars should still exist, but despite extensive searches, none have been found.ⁿ

Two Lithium Problems. The total amount of lithium seen in and outside our galaxy is only a third of what the big bang theory predicts.^o Also, “old stars contain one-quarter to one-half as much lithium-7 (made of three protons and

respected cosmologist, Jim Peebles, admitted, “*It's an embarrassment that the dominant forms of matter in the universe are hypothetical.*”^w Other authorities have said that “dark matter” and “dark energy” “*serve mainly as expressions of our ignorance.*”^u Few realize that these mystical concepts were devised to preserve the big bang theory. It is much like the supposed “missing link” that should exist between apes and man if man evolved from some apelike animal. Direct evidence does not exist.

History records other shocking discoveries that caused astronomers to assume aspects of the universe that they could not see or measure—a common practice in cosmology. Planets *appeared* to sometimes move backwards. This led to the belief, from A.D. 150 to 1543, that planets must revolve about the Earth on *epicycles*—wheels that carried planets and rode on the circumferences of other wheels. As more was learned about planetary motion, more epicycles were required to support that theory. Those cosmologists said, “After all, those wheels must be there, because that would explain the strange movements of planets.” Without direct observations or measurements, such beliefs are completely unscientific. History is repeating itself with “missing mass,” “dark matter,” “dark energy”—and an often uncritical public. Notice that these strange ideas make no predictions, that they are scientifically weak.

Instead of cluttering textbooks and the public's imagination with authoritative sounding statements about things for which no direct evidence exists, wouldn't it be better to admit that the big bang theory is faulty? Yes, but big bang theorists want to maintain their reputations, careers, funding, and worldview. If the big bang is discarded, only one credible explanation remains for the origin of the universe and everything in it. That thought sends shudders down the spines of many evolutionists.

Pages 32–34 presents evidence that is contrary to the big bang theory. “**Chemical Evolution Theory**” on page 393 describes four errors in the big bang theory that required major revisions since 1946. Each revision rejected what had been assumed without direct evidence and taught for years until calculations showed those assumptions were false. Pages 379–433 explain why the 68 heaviest chemical elements would not form after a big bang. Pages 439–453 lay out the clear evidence for the correct expansion, or “stretching out,” of the universe.

four neutrons) as [the big bang] theory predicts and contain 1,000 times more lithium-6 (three protons and three neutrons) than expected [by the big bang theory].”^p

Antimatter. For every charged particle in the universe, the big bang should have produced an identical particle but with the opposite electrical charge and spin.^q (For example, the negatively charged electron's antiparticle is the positively

charged positron, and the positively charged proton's antiparticle is the negatively charged antiproton.) Only trivial amounts of antimatter exist, even in other galaxies.^f

Other Problems. If the big bang occurred, we should not see massive galaxies or quasars at such great distances, but they are seen. [See “**Distant Galaxies**” on page 445.] Nor should a big bang produce rotating bodies^g such as galaxies and galaxy clusters. Also, a large volume of the universe should not be—but evidently is—moving sideways, almost perpendicular to the direction of apparent expansion.^h

Also, if a big bang occurred, what caused the bang? Stars with enough mass become black holes, so not even light can escape their enormous gravity. How then could anything escape the trillions upon trillions of times greater gravity caused by concentrating all the universe's mass in a “cosmic egg” that existed before a big bang?^x

If the big bang theory is correct, one can calculate the age of the universe. This age turns out to be *younger* than objects in the universe whose ages were estimated based on other evolutionary theories. Because this is logically impossible, one or both sets of theories must be incorrect.^y All these observations make it doubtful that a big bang occurred.^z

57. Heavy Elements

Evolutionists historically have had difficulty explaining the origin of heavy elements, because a big bang would produce only the three lightest elements: hydrogen, helium, and lithium. The other 100⁺ elements supposedly formed deep inside stars and during stellar explosions. This theory is hard to verify, because stellar interiors and explosions cannot be carefully analyzed. However, a vast region of gas containing the mass of 300,000,000,000,000 suns has been found that is quite rich in iron and other heavy elements. The number of nearby visible stars is a thousand times too small to account for the heavy elements in that huge region.^a Heavy elements are even relatively abundant in nearly empty regions of space that are far from stars and galaxies.^b

Most hydrogen atoms weigh one atomic mass unit, but some, called *heavy hydrogen*, weigh two units. If everything in the universe came from a big bang or from being in a swirling gas cloud for billions of years, heavy hydrogen should be uniformly mixed with normal hydrogen. It is not.^c Comets have twice the concentration of heavy hydrogen as oceans, but oceans have 10–50 times the concentration of heavy hydrogen as the solar system and interstellar matter. [See “**Heavy Hydrogen**” on page 311.]

58. Interstellar Gas

Detailed analyses have long shown that neither stars nor planets could form from interstellar gas clouds.^a To do so, either by first forming dust particles^b or by direct gravitational collapse of the gas,^c would require vastly

more time than the alleged age of the universe. An obvious alternative is that stars and planets were created.

59. Hertzsprung-Russell Diagram

The theory of stellar evolution was developed by arranging (on paper) different types of stars according to their color and absolute brightness—what is called a *Hertzsprung-Russell diagram*. A physical rationale was then devised for how stars moved from one position on the diagram to another. Supposedly, a star's age was determined by its place on the diagram. However, astronomers recognize that all stars in each massive star cluster formed at about the same time, because the stellar wind from the first stars to form would have blown out of the tight cluster the raw material needed to form all the other stars in the cluster. Despite the same age for stars in a given cluster, the Hertzsprung-Russell diagram sometimes gives drastically different ages.^a

60. Fast Binaries

In our galaxy, about 60% of all stars are grouped in closely spaced pairs called *binaries*. Fortunately, our Sun does not have a binary partner. If it did, temperatures on Earth might vary too much to support life. The mutual gravitational attraction between stars in a binary pair causes them to orbit each other, just as the Moon orbits Earth. The closer paired stars are to each other, the faster they orbit. Their orbits do not change appreciably, even over long periods of time. Two particular stars are so close that they orbit each other every 11 minutes! This implies their centers are only 80,000 miles apart.^a In comparison, our Sun, a typical star, is more than 800,000 miles in diameter. Other close binaries are also known.^b

Stellar evolutionists believe that stars slowly change from one type to another. However, scientists have never observed such changes, and many stars do not fit this pattern. According to stellar evolution, a typical star's volume, late in its lifetime, expands to about a million times that of our Sun and finally collapses to become a small star about the size of Earth (a white dwarf) or even smaller (a neutron star). Only such tiny stars could have their centers 80,000 miles apart and still orbit each other. Obviously, these fast binary stars did not evolve from larger stars, because larger stars orbiting so closely would collide. If two stars cannot evolve into a condition that has them orbiting each other every 11 minutes, one wonders whether stars evolve at all.

61. Star Births? Stellar Evolution?

Evolutionists claim that stars form from swirling clouds of dust and gas. For this to happen, vast amounts of energy, angular momentum, and residual magnetism must be removed from each cloud. This is not observed today, and astronomers and physicists have not explained, in an experimentally verifiable way, how it all could happen.^a

Stellar Nursery, or Is the Emperor Naked?

The popular media frequently claim that stars are actually seen evolving and that pictures of these “stellar nurseries” prove it. Impressive pictures of the Eagle Nebula (Figure 27) are usually shown. Many people accept the claim without asking themselves, “Do the pictures contain anything that shows stars evolving?” Of course not. If stars were evolving, other physical measurements could confirm it. Where are those measurements? Silence.

This willingness to accept what others tell us reminds one of the tale in which citizens told their naked emperor he was nicely dressed. Instead of believing or reporting what their eyes clearly told them, people preferred to accept what others said—or at least not object. Better not disagree or even ask questions; it could be embarrassing.

Why do some astronomers say stars are evolving? Until recently, the atmosphere prevented astronomers from seeing infrared radiation from space. Then, in the late 1960s, satellites outside the atmosphere made infrared sky surveys that showed some surprisingly warm clouds of dust and gas in our galaxy. Several things could cause this heating. Perhaps a dim star (*a brown dwarf*) is behind the cloud, maybe something nearby exploded, or a star is dying as it is being pulled into a massive black hole. Those who struggled to understand how stars evolved had a different interpretation: “Gravity is collapsing the cloud, raising its temperature. In about a million years, it will become a star.” Other interpretations are also possible.

NASA’s claim in 1995 that these pictures (Figure 27) showed hundreds to thousands of stars forming was based on the speculative “EGG-star formation theory.” It was tested independently in 2002 with two infrared detectors that could see inside the dusty pillars. Few stars were there, and 85% of the pillars had too little dust and gas to support star formation. “The new findings also highlight how much astronomers still have to learn about star formation.” [Ron Cowen, “Rethinking an Astronomical Icon: The Eagle’s EGG, Not So Fertile,” *Science News*, Vol. 161, 16 March 2002, pp. 171–172.]

What prevents stellar evolution? Just as the Sun’s gravity does not pull planets into the Sun, gravity does not automatically pull orbiting gas and dust into a tight ball that then ignites as a star. Each cloud of dust and gas in space has a large amount of kinetic and potential energy, angular momentum, and magnetic energy that would first have to be removed. Evidence of that removal is missing. Furthermore, any collapse would only increase the cloud’s

temperature and pressure, which, in turn, would expand the cloud. For more details on these processes, see “**Interstellar Gas**” and “**Star Births? Stellar Evolution?**” on page 34, and *especially all related endnotes starting on page 95*.

If someone tells you that the emperor is well dressed, ask questions and insist on seeing real evidence.



Figure 27: Gas and Dust Clouds in the Eagle Nebula.

The most luminous stars in our galaxy, called *O stars*, are “burning fuel” hundreds of thousands of times faster than our Sun. This is so rapid that they must be quite young on an evolutionary time scale. If these stars evolved, they should show easily measurable characteristics, such as extremely high rates of rotation and enormous magnetic fields. Because these characteristics are not observed, it seems quite likely these stars did not evolve.

Yes, we frequently see stars die as violent explosions called *supernovas*.^b Star births, on the other hand, would appear as new starlight not present on the many photographic plates made decades earlier. Instruments which can detect dust falling into and forming supposedly new stars have not done so.^c Instead, stars that some astronomers believe are very new are expelling matter. We have seen hundreds of stars die, but we have never actually seen a star born.^d

Also, some stars are found where astronomers agree they could not evolve, near the center of our galaxy. These short-lived stars orbit a massive black hole, where gravity is so strong that gas and dust clouds could never evolve into a star. Instead, the black hole’s massive gravity would pull such clouds (supposedly evolving stars) apart.^e

Nor could stars have evolved in globular clusters, where up to a million stars occupy a relatively small volume of space. [See Figure 233 on page 462.] Wind and radiation pressure from the first star in the cluster to evolve would have blown away most of the gas needed to form the other stars in the cluster.^f In other words, if stars evolved, we should not see globular clusters, yet our galaxy has about 200 globular clusters. To pack so many stars that tightly together requires that they all came into existence at about the same time.

A similar problem exists for stars that are more than 20 times more massive than our Sun. After a star grew to 20 solar masses, it would exert so much radiation pressure and emit so much stellar wind that additional mass could not be pulled in to allow it to continue to grow.^g Many stars are heavier than a hundred suns. Black holes are millions to billions of times more massive than the Sun. Poor logic is involved in arguing for stellar evolution, which is assumed in estimating the ages of stars. These ages are then used to establish a framework for stellar evolution. That is circular reasoning.^h

In summary, there is no evidence that stars evolve, there is much evidence that stars did not evolve, and there are no experimentally verifiable explanations for how they could evolve and seemingly defy the laws of physics.ⁱ

62. Galaxies

Evolutionists now admit that galaxies cannot evolve from one type to another.^a There are also good reasons that natural processes cannot form galaxies.^b Furthermore, if



Figure 28: Spiral Galaxies.

spiral galaxies were billions of years old, their arms or bars would be severely twisted.^c [See Figure 230 on page 455.] Because they have maintained their shape, either galaxies are young, or unknown physical phenomena are occurring within galaxies.^d Even structures composed of galaxies are now known to be so amazingly large and so elongated that they could not have formed by slow gravitational attraction.^e *Slow, natural* processes cannot form such huge galactic structures; rapid, supernatural processes may have.

Techniques That Argue for an Old Earth Are Either Illogical or Based on Unreasonable Assumptions.

63. Radiometric Dating

To date an event or thing that preceded written records, one must assume that the dating clock has operated at a known rate, that the clock’s initial setting is known, and that the clock has not been disturbed. These three assumptions are almost always unstated, overlooked, or invalid.

For the past century, a major (but incorrect) assumption underlying all radioactive dating techniques has been that decay rates, which have been essentially constant over the past 100 years, have also been constant over the past 4,600,000,000 years. Unfortunately, few have questioned this huge and critical assumption.^a

It is also critical that one understands how dating clocks work. For radiometric dating clocks on Earth, this is explained in the chapter “**The Origin of Earth’s Radioactivity**” on pages 379–433. After studying that chapter, you will see that Earth’s radioactivity—and the many daughter products that so many misinterpreted to mean that the Earth was billions of years old—are a result of powerful electrical activity during the flood, only about 5,000 years ago.



Figure 29: 70,000,000-Year-Old Fish? Thought to have been extinct for 70,000,000 years, the coelacanth (SEE-la-kanth) was first caught in 1938, deep in the Indian Ocean, northwest of Madagascar. Rewards were then offered for coelacanths, so hundreds were caught and sold. In 1998, they were also found off the coast of Indonesia.^c How could the ancestors of these coelacanths leave no fossils for 70,000,000 years? (Endnotes here are under “**Index Fossils**” on pages 97–99.)

Before coelacanths were caught, evolutionists incorrectly believed that the coelacanth had lungs, a large brain, and four bottom fins *about to evolve into legs*.^d Evolutionists reasoned that the coelacanth, or a similar fish, crawled out of a shallow sea and filled its lungs with air, becoming the first four-legged land animal. Millions of students have been incorrectly taught that this fish was the ancestor of all amphibians, reptiles, dinosaurs, birds, and mammals, including people. (Was your ancestor a fish?)

J. L. B. Smith, a well-known fish expert from South Africa, studied the first two captured coelacanths (nicknamed the coelacanth “Old Fourlegs”) and wrote a book by that title in 1956. When dissected, did they have lungs and a large brain? Not at all.^e Furthermore, in 1987, a German team filmed six coelacanths in their natural habitat. They were *not* crawling on all fours!^f

Before living coelacanths were found in 1938, evolutionists dated any rock containing a coelacanth fossil as at least 70,000,000 years old. It was an index fossil. Today, evolutionists frequently express amazement that coelacanth fossils look so much like captured coelacanths—despite more than 70,000,000 years of evolution.^g If that age is correct, billions of coelacanths would have lived and died. Some should have been fossilized in younger rock and should be displayed in museums. Their absence implies that coelacanths have not lived for 70,000,000 years.



Figure 30: Stalagmites. Water from an underground spring was channeled to this spot on a river bank for only one year. In that time, limestone built up around sticks lying on the bank. Limestone deposits can form rapidly if the groundwater’s chemistry is favorable. Just because stalactites and stalagmites are growing slowly today does not mean they must be millions of years old. As we will see in Part II, conditions after the flood provided the ideal chemistry for rapidly forming such features.

64. Corals and Caves

Estimated old ages for the Earth are frequently based on “clocks” that today are ticking at extremely slow rates. For example, coral growth rates were thought to have *always* been very slow, implying that some coral reefs must be hundreds of thousands of years old. More accurate measurements of these rates under favorable growth conditions now show that no known coral formation need be older than 3,400 years.^a A similar comment can be made for growth rates of stalactites and stalagmites in caves.^b [See [Figure 153](#) on page 263.]

65. Index Fossils

In the early 1800s, some observers in Western Europe noticed that certain fossils are usually preserved in sedimentary rock layers that, when traced laterally, typically lie above somewhat similar fossils. Decades later, after the theory of evolution was proposed, many concluded that the lower organism must have evolved before the upper organism. These early geologists did not realize that a hydrodynamic mechanism, *liquefaction*, helped sort organisms in that order during the flood. [For an explanation, see pages 195–213.]

Geologic ages were then associated with each of these “index fossils.” Those ages were extended to other animals and plants buried in the same layer as the index fossil. For example, a coelacanth fossil, an index fossil, dates its layer at 70,000,000 to 400,000,000 years old. [See [Figure 29](#).] Today, geologic formations are almost always dated by their fossil content^a—which, as stated above, assumes evolution. Yet, evolution is supposedly shown by the



Figure 31: Humanlike Footprints with Trilobite. In 1968, 43 miles northwest of Delta, Utah, William J. Meister found this and other apparent human shoe prints inside a 2-inch-thick slab of rock. Also in that slab were obvious trilobite fossils, one of which was squashed under the “heel.” The 10-inch-long shoe print is at the left, and its rock mold is to its right. According to evolutionists, trilobites became extinct 240-million years *before* humans evolved. Notice how the back of the heel is worn, just as most of our shoes wear today. The heel was indented in the rock about an eighth of an inch deeper than the sole. Others have since made similar discoveries at this location, although this is the only fossil where a trilobite was *inside* an apparent shoe print.

sequence of fossils. Because this reasoning is *circular*,^b many discoveries, such as living coelacanths,^{c-g} were unexpected. [See “[Out-of-Sequence Fossils](#)” on page 13.]

66. Humanlike Footprints

Humanlike footprints, supposedly 150–600-million years old, have been found in rock formations in Utah,^a Kentucky,^b Missouri,^c and possibly Pennsylvania.^d At Laetoli, in the east African country of Tanzania, a team headed by Mary Leakey found a sequence of humanlike footprints.^e They were dated at 3.7-million years. If human feet made any of these prints, then evolutionary chronology is drastically wrong.

67. Geologic Column

Practically nowhere on Earth can one find the so-called “*geologic column*.”^a Most “geologic periods” are missing at most continental locations. Only 15–20% of Earth’s land surface has one-third of these periods in the correct order.^b Even within the Grand Canyon, more than 100-million years of this imaginary column are missing.^c Using the assumed geologic column to date fossils and rocks is fallacious.

68. Old DNA, Bacteria, Proteins, and Soft Tissue?

DNA. When an animal or plant dies, its DNA begins decomposing.^a Before 1990, almost no one believed that DNA could last 10,000 years.^b This limit was based on

measuring DNA disintegration rates in *well-preserved* specimens of known age, such as Egyptian mummies. DNA has now been reported in supposedly a 400,000-year-old hominin femur from Spain,^c 17-million-year-old magnolia leaves,^d and 11-to-425-million-year-old salt crystals.^e Dozens of plants and animals have left DNA in sediments claimed to be 30,000–400,000 years old.^f DNA fragments have been found in the scales of a “200-million-year-old” fossilized fish^g and possibly in “80-million-year-old” dinosaur bones buried in a coal bed.^h Frequently, DNA is found in insects and plants encased in amber samples, assumed to be 25–120-million years old.ⁱ

These discoveries have forced evolutionists to reexamine the 10,000-year limit.^j They now claim that DNA can be preserved longer if conditions are dryer, colder, and freer of oxygen, bacteria, and background radiation. However, measured disintegration rates of DNA, under these more ideal conditions, do not support this claim.^k

Bacteria. Even living bacterial spores have been recovered, cultured, and identified in intestines of bees preserved in supposedly 25–40-million-year-old amber.^l The same bacteria, *Bacillus*, have been found alive in rocks allegedly 250 million and 650-million years old.^m Italian scientists have recovered 78 different types of dormant, but living, bacteria in two meteorites that are presumed to be 4.5-billion years old.ⁿ Anyone who accepts such old ages for these rocks must also accept that some bacteria are practically immortal—an obviously absurd conclusion. (Because these “old” bacteria and the various DNA specimens closely match those of today, little evolution has occurred.)

Proteins and Soft Tissue. Evolutionists face similar contradictions with proteins,^o soft tissue,^p blood compounds,^q and other complex organic matter^r preserved in dinosaur bones.^s Researchers were shocked to find soft tissue in eight pieces of a dinosaur's toe, rib, hip, leg, and claw.^t Even dinosaur skin (from a hadrosaur) has been recovered and tested.^u As with DNA, it is ridiculous to believe these remains have lasted 65–150-million years.^v

69. Human Artifacts

At various times and places, man-made objects have been found encased in coal. Examples include a thimble,^a an iron pot,^b an iron instrument,^c an 8-karat gold chain,^d three throwing-spears,^e and a metallic vessel inlaid with silver.^f Other “out-of-place artifacts” have been found inside deeply buried rocks: nails,^g a screw,^h a strange coin,ⁱ a tiny ceramic doll,^j and other objects of obvious human manufacture.^k By evolutionary dating techniques, these objects would be hundreds of millions of years older than man. Again, something is wrong.

70. Parallel Layers

Because no worldwide or even continental unconformity exists in Earth's sedimentary layers, those layers must have been deposited rapidly. (An **unconformity** represents a time break of unknown duration—for example, an erosional surface between two adjacent strata.) Parallel layers (called **conformities**) imply continuous, relatively rapid deposition. Because unconformities are simply local phenomena,^a one can trace continuous paths from the bottom to the top of the stratigraphic record by simply moving around these time breaks. The sedimentary layers along those paths must have been deposited rapidly and continuously as a unit.^b

Frequently, two adjacent and parallel sedimentary layers contain such different index fossils that evolutionists conclude they were deposited hundreds of millions of years apart. However, because the adjacent layers are conformable, they must have been deposited without interruption or erosion. [For an explanation of how conformable layers can have such different fossils, see pages 195–213.] Often, in sequences showing no sign of disturbance, the layer considered older by evolutionists is on top! [See “**Out-of-Sequence Fossils**” on page 13.] Evolutionary dating rules are self-contradictory.^c

Most Scientific Dating Techniques Indicate That the Earth, Solar System, and Universe Are Young.

For the last 150 years, the age of the Earth, as assumed by evolutionists, has been doubling at roughly a rate of once every 15 years. In fact, since 1900 this age has multiplied by a factor of 100!

Evolution requires an old Earth, an old solar system, and an old universe. Nearly all informed evolutionists will admit that without billions of years their theory is dead. Yet, hiding the “origins question” behind a vast veil of time makes the unsolvable problems of evolution difficult for scientists to see and laymen to imagine. Our media and textbooks have implied for over a century that these almost unimaginable ages are correct. Rarely do people examine the shaky assumptions and growing body of contrary evidence. Therefore, most people today almost instinctively believe that the Earth and universe are billions of years old. Sometimes, these people are disturbed, at least initially, when they see the actual evidence.

Actually, most dating techniques indicate that the Earth and solar system are young—possibly less than 10,000 years old. Here are some of these points of evidence.

71. Helium

One product of radioactive decay within rocks is helium, a light gas. This helium enters the atmosphere at a much faster rate than helium escapes the atmosphere. (Large amounts of helium should not escape into outer space, even when considering helium's low atomic weight.) Radioactive decay of only uranium and thorium would produce all the atmosphere's helium in only 40,000 years. Therefore, the atmosphere appears to be young.^a

72. Lead and Helium Diffusion

Lead diffuses (or leaks) from zircon crystals at known rates that increase with temperature. Because these crystals are found at different depths in the Earth, those at greater depths and temperatures should have less lead. If the Earth's crust is just a fraction of the age claimed by evolutionists, measurable differences in the lead content of zircons should exist in the top 4,000 meters. Instead, no measurable difference is found.^a

Similar conclusions are reached based on the helium content in these same zircon crystals.^b Because helium escapes so rapidly and so much helium is still in zircons, they (and Earth's crust) must be less than 10,000 years old.^c Furthermore, the radioactive decay that produced all that helium must have happened quite rapidly, because the helium is trapped in *young* zircons.

73. Excess Fluid Pressure

Abnormally high oil, gas, and water pressures exist within relatively permeable rock.^a If these fluids had been trapped more than 10,000 to 100,000 years ago, leakage would have dropped these pressures far below what they are today. This oil, gas, and water must have been trapped suddenly and recently.^b

74. Volcanic Debris

Volcanoes eject almost a cubic mile of material into the atmosphere each year, on average. At this rapid rate, about 10 times the entire volume of Earth's sedimentary rock should be produced in 4.5-billion years. Actually, only about 25% of Earth's sediments are of volcanic origin, and much greater volcanic activity existed in the past. No means have been proposed for removing or transforming all the missing volcanic sediments. Therefore, Earth's sediments seem to be much younger than 4.5-billion years.^a

75. River Sediments

More than 27 billion tons of river sediments enter our oceans each year. Probably the rate of sediment transport is diminishing as looser topsoil is removed and as erosion smooths out Earth's terrain. Even if erosion has been constant, the sediments now on the ocean floor would have accumulated in only 30-million years. No process has been proposed which can remove 27-billion tons of ocean sediments each year. So, the oceans cannot be hundreds of millions of years old.^a

76. Continental Erosion

The continents are eroding at a rate that would level them in much less than 25-million years.^a However, evolutionists believe that fossils of animals and plants at high elevations have somehow avoided this erosion for more than 300-million years. Something is wrong.

77. Dissolved Metals

Rivers carry dissolved elements, such as copper, gold, lead, mercury, nickel, silicon, sodium, tin, and uranium into oceans at very rapid rates when compared with the small quantities of these elements already in the oceans. In other words, far fewer than a million years' worth of metals are dissolved in the oceans.^a There is no known means by which large amounts of these elements can come out of solution. Therefore, the oceans must be much younger than a million years.

78. Crater Creep

A tall pile of tar will slowly flow downhill, ultimately spreading into a nearly horizontal sheet of tar. Most material, under pressure, "creeps" in this way, although rocks deform very, very slowly.

Calculations show that the growing upward bulges of large crater floors on the Moon should reach their current extent in only 10,000 to 10,000,000 years.^a Large, steep-walled craters exist even on Venus and Mercury, where temperatures are hot enough to melt lead. Therefore, creep rates on those planets should be even greater. Most

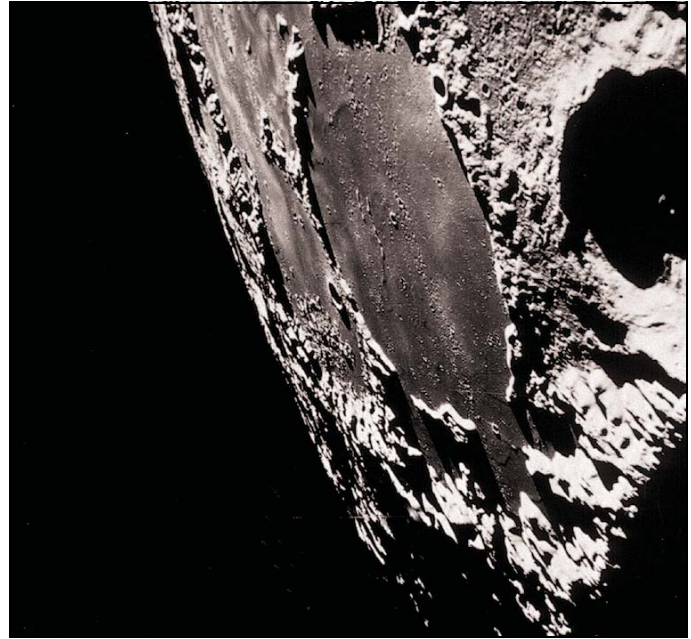

Figure 32: Young Craters. Large craters on the Moon have high, steep walls that should be slowly slumping and deep floors that should be bulging upward. Little deformation exists, so these craters appear relatively young. Similar conclusions can be drawn for Venus and Mercury.

large craters on the Moon, Venus, and Mercury are thought to have formed more than 4,000,000,000 years ago. Because these craters show no sign of "creep," these bodies seem to be relatively young.

79. Shallow Meteorites

Meteorites are steadily falling onto Earth. This rate was probably much greater in the past, because planets have swept from the solar system much of the original meteoritic material. Therefore, experts have expressed surprise that meteorites are almost always found in young sediments, very near Earth's surface.^a (Unsuccessful searches have been made for these deep—and very valuable—meteorites, including in the Grand Canyon and along conveyor belts in coal processing plants.) Even meteoritic particles in ocean sediments are concentrated in the topmost layers.^b If Earth's sediments, which average about a mile in thickness on the continents, were deposited over hundreds of millions of years, as evolutionists believe, we would expect to find many deeply buried iron meteorites. Because this is not the case, the sediments were probably deposited rapidly, followed by "geologically recent" meteorite impacts. Also, because no meteorites are found directly above the basement rocks on which these sediments rest, those basement rocks were not exposed to meteoritic bombardment for any great length of time.

Similar conclusions can be made about rock slides, which are usually found at the Earth's surface.^c

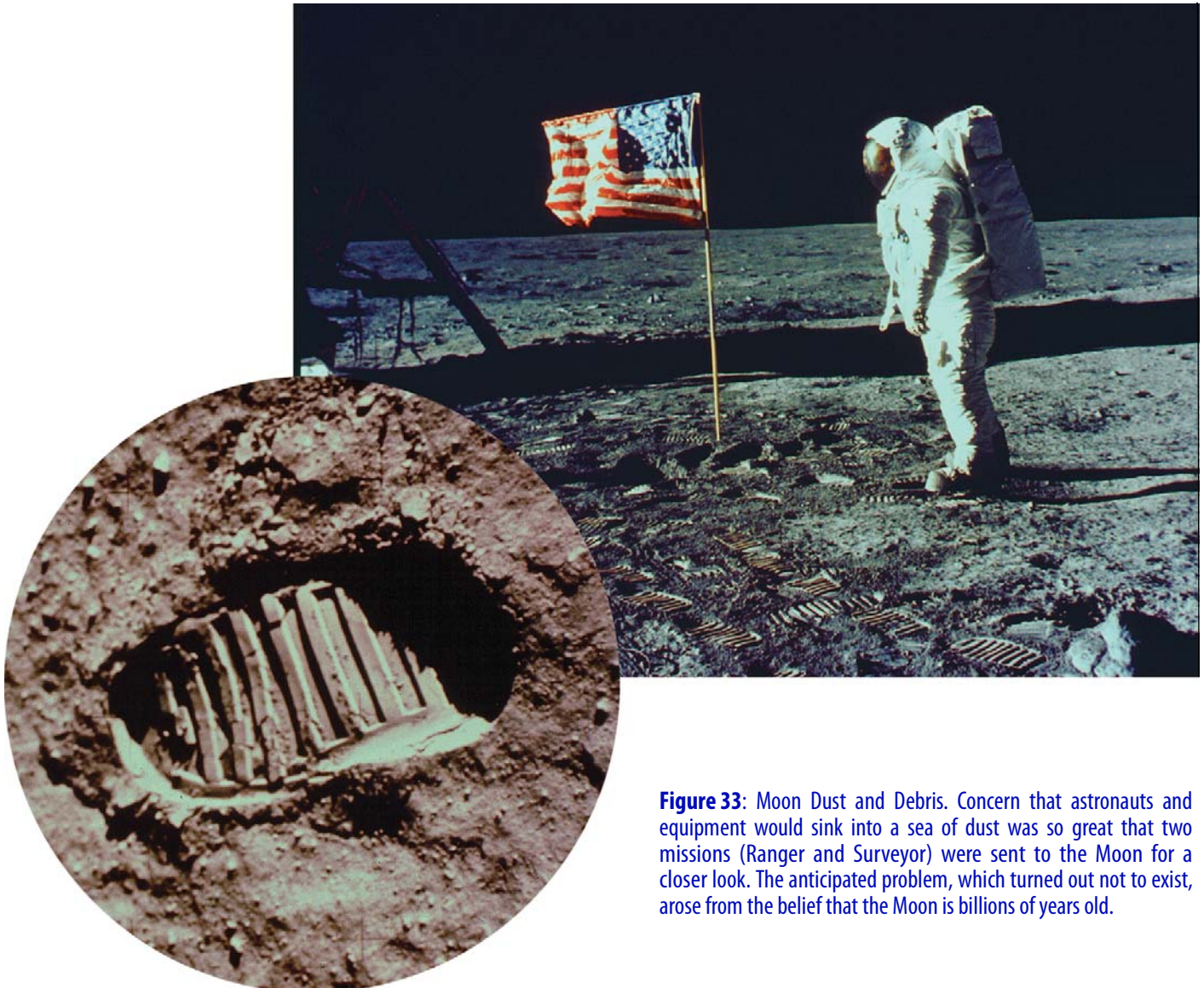

Figure 33: Moon Dust and Debris. Concern that astronauts and equipment would sink into a sea of dust was so great that two missions (Ranger and Surveyor) were sent to the Moon for a closer look. The anticipated problem, which turned out not to exist, arose from the belief that the Moon is billions of years old.

80. Moon Dust and Debris

If the Moon were billions of years old, it should have accumulated a thick layer of dust and debris from meteoritic bombardment. Before instruments were placed on the Moon, some scientists were very concerned that astronauts would sink into a sea of dust—possibly a mile in thickness.^a This did not happen. Very little meteoritic debris is on the Moon. In fact, after examining rocks and dust brought back from the Moon, scientists learned that only about 1/67 of the dust and debris came from outer space. Recent measurements of the influx rate of meteoritic material on the Moon also do not support an old Moon.^b [For more details, see pages 583–585.]

81. Meteoritic Dust

Meteoritic dust is accumulating on Earth so fast that, after 4-billion years (at today's low and diminishing rate), the equivalent of more than 16 feet of this dust should have accumulated. Because this dust is high in nickel,

Earth's crust should have abundant nickel. No such concentration has been found on land or in the oceans. Therefore, Earth appears to be young.^a

82. Rapid Cooling

If the Earth began in a molten state, it would have cooled to its present condition in much less than 4.5-billion years. This conclusion holds even if one makes liberal assumptions for the amount of heat generated by radioactive decay within Earth.^a The known temperature pattern inside Earth is consistent only with a young Earth.

83. Moon Recession

As tidal friction gradually slows Earth's spin, the laws of physics require the Moon to recede from Earth. (Edmond Halley first detected this recession in 1695.) Even if the Moon began orbiting near Earth's surface, the Moon should have moved to its present distance from Earth in billions of years less time than the 4.5-billion-year age evolutionists

assume for the Earth and Moon. So, the Earth-Moon system must be much younger than evolutionists assume. [For details, see pages 576–580.]

84. Hot Moon

A surprising amount of heat is flowing out of the Moon from just below its surface, and yet the Moon's interior is relatively cold.^a Because it has not yet cooled off, the Moon is much younger than most people had guessed,^b or recent events have altered the Moon's heat flow^c—or both.

85. Young Comets

As comets pass near the Sun, some of their mass vaporizes, producing a long tail.^a Comets also fragment frequently or crash into the Sun^b or planets. Typical comets should disintegrate after several hundred orbits. For many comets, this is less than 10,000 years. There is no evidence for a distant shell of cometary material surrounding the solar system, and there is no known way to add comets to the solar system at rates that even remotely balance their destruction.^c Actually, the gravity of planets tends to expel comets from the solar system, not capture them.^d So, comets and the solar system appear to be less than 10,000 years old. [For more on comets, see “[The Origin of Comets](#)” on pages 301–335.]

86. Small Comets

Photographs taken from Earth-orbiting satellites show small, ice-filled comets striking Earth's upper atmosphere at an average rate of one every three seconds.^a [See [Figure 34](#).] Each comet adds 20–40 tons of water to Earth's atmosphere. If this influx began when evolutionists say the Earth started to evolve, all our oceans would have come from small comets. No doubt past impact rates were even greater, because the planets have swept many of these comets from the solar system. Therefore, small comets would have placed much more water on Earth than is here today. Obviously, this did not happen, so oceans look young. [See also pages 310 and 318.]

87. Hot Planets

Jupiter, Saturn, and Neptune each radiate away more than twice the heat energy they receive from the Sun.^a Uranus^b and Venus^c also radiate too much heat. Calculations show that it is very unlikely that this energy comes from nuclear fusion,^d radioactive decay, gravitational contraction, or phase changes^e within those planets. This suggests that these planets have not existed long enough to cool off.^f

88. Solar Wind

The Sun's radiation applies an outward force on particles orbiting the Sun. Particles less than about one 100,000th

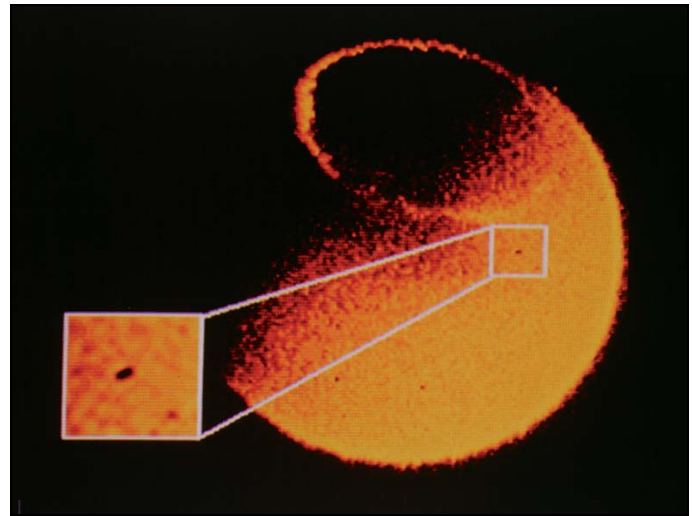

Figure 34: Small Comets. The Dynamic Explorer satellite took this picture in ultraviolet light showing small comets (the dark spots) colliding with Earth's upper atmosphere. The comets begin to break up 800 miles above the Earth's surface, then frictional heating vaporizes the pieces and their descent stops at an elevation of about 35 miles. The water vapor, which soon dissipates, blocks ultraviolet light from Earth, producing the dark spots. The northern lights are shown by the halo.

of a centimeter in diameter should have been “blown out” of the solar system if it were billions of years old. Yet, these particles are still orbiting the Sun.^a Conclusion: the solar system appears young.

89. Poynting-Robertson Effect

Dust particles larger than about one 100,000th of a centimeter in diameter form a large disk-shaped cloud that orbits the Sun between the orbits of Venus and the asteroid belt. (This cloud produces *zodiacal light*.^a) Forces acting on these dust particles (called *the Poynting-Robertson effect*) should spiral most of them into the Sun in less than 10,000 years. Known forces and sources of replenishment cannot maintain this cloud, so the solar system is probably less than 10,000 years old.

Just as some rain falling on a speeding car strikes the front of the car and slows it down slightly, with the Poynting-Robertson effect, the Sun's rays strike tiny particles orbiting the Sun, slowing them down, so they spiral into the Sun. Thus, the Sun's radiation and gravity act as a giant vacuum cleaner that pulls in about 100,000 tons of micrometeoroids per day. Disintegrating comets and asteroids add dust at less than half the rate it is being destroyed.^b

A disintegrating comet becomes a cluster of particles called a *meteor stream*. The Poynting-Robertson effect causes smaller particles in a meteor stream to spiral into the Sun more rapidly than larger particles. After about 10,000 years, these orbits should be visibly segregated by particle size. Because this segregation is generally not seen, meteor streams are probably a recent phenomenon.^c

Huge quantities of microscopic dust particles also have been discovered around some stars.^d Yet, according to the theory of stellar evolution, those stars are many millions of years old, so that dust should have been removed by stellar wind and the Poynting–Robertson effect. Until some process is discovered that continually resupplies vast amounts of dust, one should consider whether the “millions of years” are imaginary.

90. Supernova Remnants

In galaxies similar to our Milky Way Galaxy, a star will explode every 26 years or so.^a These explosions, called *supernovas*, produce gas and dust that expand outward thousands of miles per second. With radio telescopes, these remnants in our galaxy should be visible for a million years. However, only about 7,000 years’ worth of supernova debris are seen.^b So, the Milky Way looks young. [See Figure 35.]

91. Connected Galaxies

Galaxies frequently appear connected or aligned with other galaxies or quasars that have vastly different redshifts. This happens too often for all examples to be coincidences.^a If redshifts imply velocities (which is most likely), these galaxies and quasars have not been moving apart for very long. If redshifts do not always imply velocities, many astronomical conclusions are in error.

92. Unstable Galaxies

Computer simulations of the motions of spiral galaxies show them to be highly unstable; they should completely change their shape in only a small fraction of the universe’s assumed evolutionary age.^b The simplest explanation for so many spiral galaxies, including our Milky Way Galaxy, is that they and the universe are much younger than has been assumed.

Planet-size bodies are sometimes found inside triple-star systems. Since it is simply a matter of time before those bodies are expelled from such systems, the simple fact that they have not been expelled from their unstable orbits by the chaotic gravitational attraction of those stars, means that those systems and their planet-size bodies are young.

93. Galaxy Clusters

Hundreds of rapidly moving galaxies often cluster tightly together. Their relative velocities, as inferred by the redshifts of their light, are so high that these clusters should be flying apart, because each cluster’s visible mass is much too small to hold its galaxies together gravitationally.^a Because galaxies within clusters are so close together, they have not been flying apart for very long.

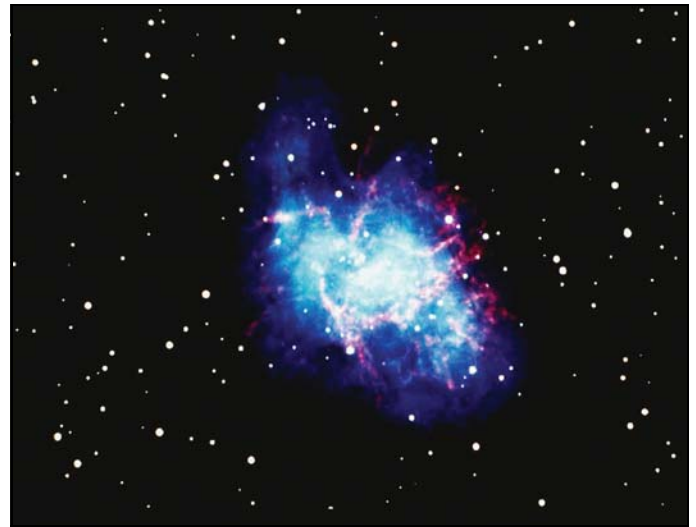

Figure 35: The Crab Nebula. In A.D. 1054, Chinese observers (and perhaps Anasazi Indians in New Mexico and Arizona) witnessed and described a supernova. It was visible in daylight for 23 days and briefly was as bright as a full moon. Today, remnants from that explosion comprise the Crab Nebula.

Thanks to radio telescopes, most of these remnants should be visible for a million years. At the rate supernovas are occurring in galaxies like ours, we have only about 7,000 years’ worth of remnants.

A similar statement can be made concerning many stars in spiral galaxies and gas clouds that surround some galaxies.^b These stars and gas clouds have such high velocities that they should have broken their “gravitational bonds” long ago—if they were billions of years old. If redshifted starlight always indicates a star’s velocity, then a multi-billion-year-old universe is completely inconsistent with what is observed.

These observations have led some to conclude, not that the universe is young, but that unseen, undetected mass—called *dark matter*—is holding these stars and galaxies together. For this to work, about 85% of the mass in the universe must be invisible—and hidden in the right places. However, many experiments have shown that the needed “dark matter” does not exist.^c Some researchers are still searching, because the alternative is a young universe. [See “**Dark Thoughts**” on page 33.]

Conclusion

All dating techniques, especially the few that suggest vast ages, presume that a process observed today has proceeded at a known, but not necessarily constant, rate. This assumption may be grossly inaccurate. Projecting present processes and rates far back in time is more likely to produce errors than extrapolation over a much shorter time. Also, a much better understanding usually exists for dating “clocks” that show a young Earth and a young universe.

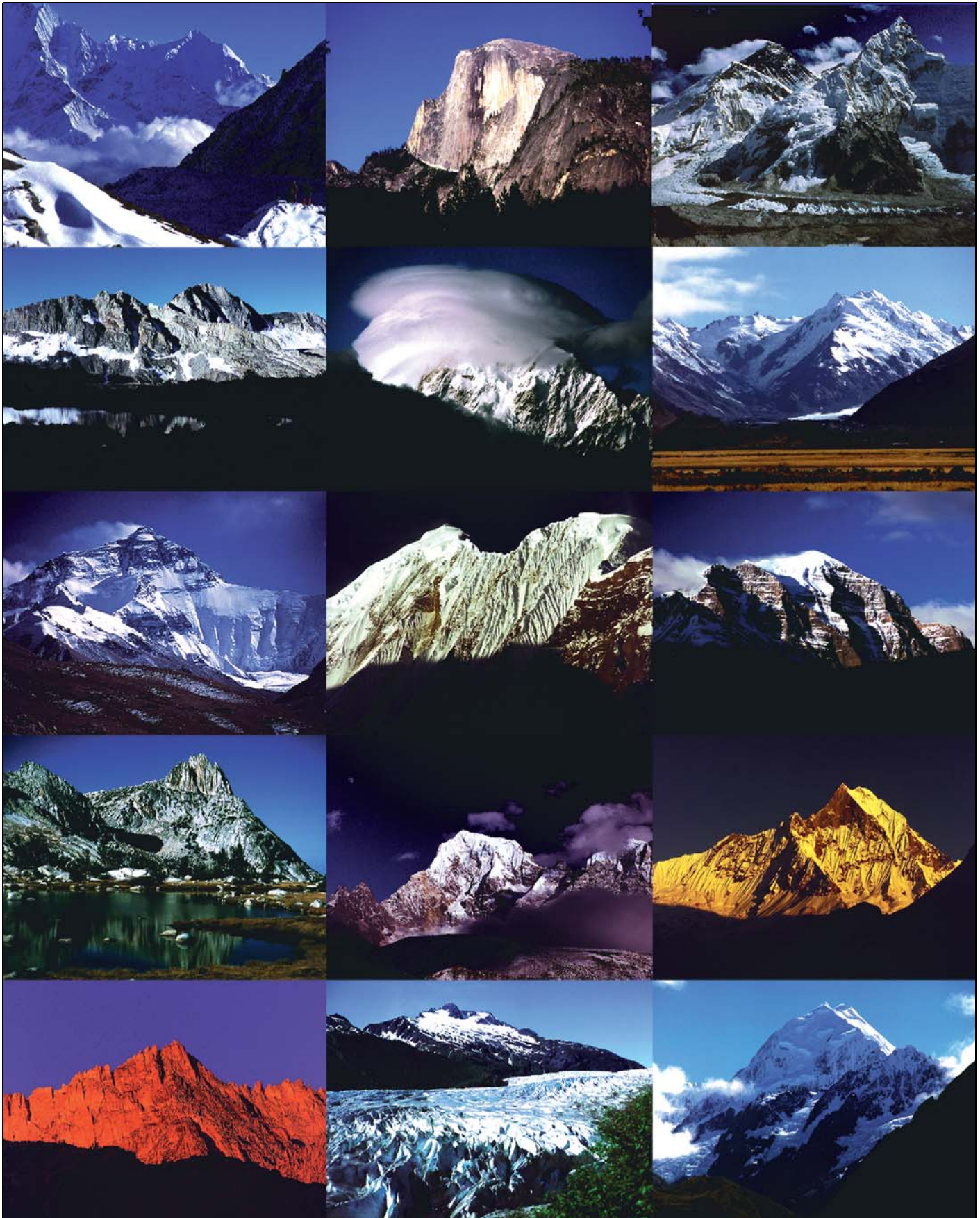

Figure 36: Mountains of the World.

Earth Sciences

The Earth Has Experienced a Worldwide Flood.

Noah's Ark Probably Exists.^a

The precise location of the Ark is an open question. While most sightings point to Mount Ararat in eastern Turkey, consideration should also be given to a few nearby mountains in western Iran. The following are the more credible claimed sightings. Some are undoubtedly mistaken. The search continues.

94. Ancient Historians

Ancient historians, such as Josephus, the Jewish-Roman historian, and his earlier historical sources, wrote that the Ark existed. Marco Polo was also told that the Ark was on a very high, perpetually snow-covered mountain in central Armenia.^a From A.D. 200 to 1700, more than a dozen other Christian and Jewish leaders wrote that the Ark was still preserved, although few claimed to have seen it.

95. British Scientists

In about 1856, three skeptical British scientists and two Armenian guides climbed Mount Ararat to show that the Ark did not exist. Allegedly, the Ark was found, and the British scientists threatened to kill the guides if they reported the find. Years later, one of the Armenians (then living in the United States) and one of the British scientists independently reported they had found the Ark.

96. James Bryce

Sir James Bryce, a noted British scholar and traveler of the mid-nineteenth century, conducted extensive library



Figure 37: Mount Ararat in Eastern Turkey. The 17,000-foot peak of Greater Ararat is just above my head. Even in August, snow and ice cover the top 3,000 feet. For one week in 1990, this Soviet helicopter and its crew flew our eight-man team over and around Ararat. Evaporation from the ice cap produces clouds around the peak for most of the day—complicating the search for the Ark. Another difficulty is the hostility between Kurds who live in this region and the Turkish government. Both sides claim control over the mountain and insist that only their exploration permits are valid.

research concerning the Ark. He became convinced that the Ark was preserved on Mount Ararat. Finally, in 1876, he climbed Ararat and found, at the 13,000-foot level (2,000 feet above the timberline), a piece of hand-tooled wood, four feet long, that he believed might be from the Ark.

97. Turkish Commissioners

In 1883, a series of newspaper articles reported that a team of Turkish commissioners, while investigating avalanche conditions on Mount Ararat, unexpectedly came upon the Ark projecting out of melting ice after an unusually warm summer. They claimed they entered and examined part of the Ark.

98. George Hagopian

In an unusually warm summer (about 1904), a 10-year-old Armenian boy, George Hagopian, and his uncle climbed Mount Ararat and supposedly reached the Ark. The boy climbed on top of it and described the structure as a flat-bottomed, petrified barge without nails. It had many windows on top, each “big enough for a cow to walk through.” [See Figures 39 and 41.] Two years later, Hagopian again visited the Ark. Shortly before his death in 1972, his detailed testimony was tape recorded. A voice analyzer test (PSE test) gave no indication of lying.^a

99. Russian Expeditions

A Russian pilot flying over Ararat in World War I (1916) thought he saw the Ark. News of his discovery reached the Czar, who sent two large expeditions to the site. The soldiers found and explored the boat, but before they could report to the Czar, the Russian Revolution of 1917 began. Their report disappeared, and the soldiers scattered. Some eventually reached the United States and Canada. Although a much later magazine account had a few fictional elements, further investigations have confirmed the primary details.^a In February 2000, Joseph Kulik, an alleged expedition member, was interviewed. Details he provided duplicate those in other accounts.^b

100. Ed Davis

In July 1943, Sergeant Ed Davis (U.S. Army) was stationed in Iran. There, he developed a close friendship with some Lur tribesmen who said they knew the location of Noah’s Ark. (The Lurs are related to the Kurds.) When Davis asked to see the Ark, they first took him to their village. There, Davis claims he saw items from the Ark: a cage door, latches, a metal hammer, dried beans, shepherd staffs, oil lamps, bowls, and pottery jars still containing honey. This Muslim tribe considered it a religious duty to prevent outsiders from seeing the Ark, even if killing was necessary. However, their close friendship with Davis made him an exception.

Tribal leader Abas-Abas and his seven sons took Davis on a three-day climb up the northeast side of what Davis *thought* was Mount Ararat. (Based on Davis’ description



Figure 38: Ed Davis with Elfred Lee in 1986. Artist Elfred Lee (right) drew this picture based on the claimed eyewitness account of Ed Davis (left). In 1970, Lee also drew a picture of the Ark in the presence of another claimed eyewitness, George Hagopian. (The Ark depicted on page 49 is based on Lee’s drawing for Hagopian.) Because both Hagopian and Davis were present as Lee made each drawing, they requested many on-the-spot changes. As Lee was completing Davis’ drawing, he suddenly felt that each man was describing the same object. This, Lee said, made the hair on the back of his neck stand up.

of his trip, he probably was on a mountain in Iran.)^a Steep, slick rocks, made worse by cold rain, prevented them from getting closer than one-half mile from the Ark. Two broken portions of the Ark, lying on their sides and one-third of a mile apart, were visible during moments when fog and clouds lifted. Wooden beams, three decks, and rooms were seen. Abas-Abas told Davis other details: the Ark’s wood was extremely hard; wooden pegs were used in its construction instead of nails; its large, side door opened from the bottom outward (like a garage door); and the human quarters consisted of 48 compartments in the middle of the top deck. In 1986, several dozen Ark researchers questioned Davis extensively, and in 1989 he passed a lie detector test.^b (On two occasions, once in his home, I also questioned Davis.)

101. George Greene

George Greene, an oil geologist, reportedly took several photographs of the Ark in 1953 from a helicopter. After returning to the United States, Greene showed his photographs to many people but could not raise financial backing for a ground-based expedition. Finally, he went to South America where he was killed. Although his pictures have not been found, more than 30 people have given sworn, written testimony that they saw these photographs that clearly showed the Ark protruding from melting ice at the edge of a precipice.

The CIA's "Ararat Anomaly"

In 1974, during a private meeting with William Colby, Director of the Central Intelligence Agency (CIA), I asked if he was aware of the claimed sightings of Noah's Ark. He said he was not. After summarizing several "sightings," I stated that a dangerous and expensive search for an object with profound international importance could be done safely and cheaply with technology Colby controlled. Perhaps the CIA already had information in its files that could help in this search.

Weeks later, I was contacted by a man I will call H.S. He said that Director Colby asked him to see if any information could be provided. In our discussions, H.S. asked many questions. About a year later he called to say his work was completed and to invite me to CIA headquarters in Langley, Virginia. In his office, H.S. said he had examined all photography of the Mount Ararat region. He could not be sure if an object he was seeing was the Ark or a rock. I asked H.S. if, after studying the information on the various claimed sightings, he thought the Ark was on Ararat. He said, "Yes." I asked why, because he had just told me that no photographs clearly showed the Ark. H.S. responded (with obvious reference to the many consistent, but unverified, claims of Ark sightings), "There is too much smoke for there not to be fire." I had great confidence in his analytical rigor and candor. Suggestions that any agency of the U.S. government would (or could for long) withhold conclusive evidence that Noah's Ark exists are implausible.

[For details on what follows, see Timothy W. Maier, "Anomaly or Noah's Ark?" *Insight on the News*, 20 November 2000, pp. 10–14, 25–27.] The CIA calls this object the "Ararat Anomaly." It was first photographed by a fixed-wing aircraft in 1949 and later by a U-2 in 1956. Satellites photographed it in 1973, 1976, 1990, and 1992. Some low-resolution, 1949 photographs have been released to the public, thanks to the efforts of law professor Porcher Taylor. In 1999 and 2000, private funds paid for the best private sector satellite (IKONOS) to photograph the object at a resolution of 1 meter. (Some CIA photographs had a 6-inch resolution—enough magnification to see a soccer ball from space.)

Insight asked seven diverse photo analysts to independently study the available low-resolution photographs. Two analysts said it was likely a rock, four said it could be a man-made object, and one called the evidence inconclusive. Some factors considered were: shape, dimensions, shadows, color, surface texture, thermal characteristics, nearby snow and rock patterns, and possible movement of the object.

This is probably not the Ark, because it has too little in common with the most credible sightings, especially its specific location on Ararat. However, if the Turkish government gives permission, an expedition could go to the location of the "Ararat Anomaly" (39.703°N, 44.275°E, 15,300 feet elevation) and dig into the ice. Unfortunately, the Kurdish rebellion in eastern Turkey and the Turkish military's tight control have prevented access to important areas on Mount Ararat.

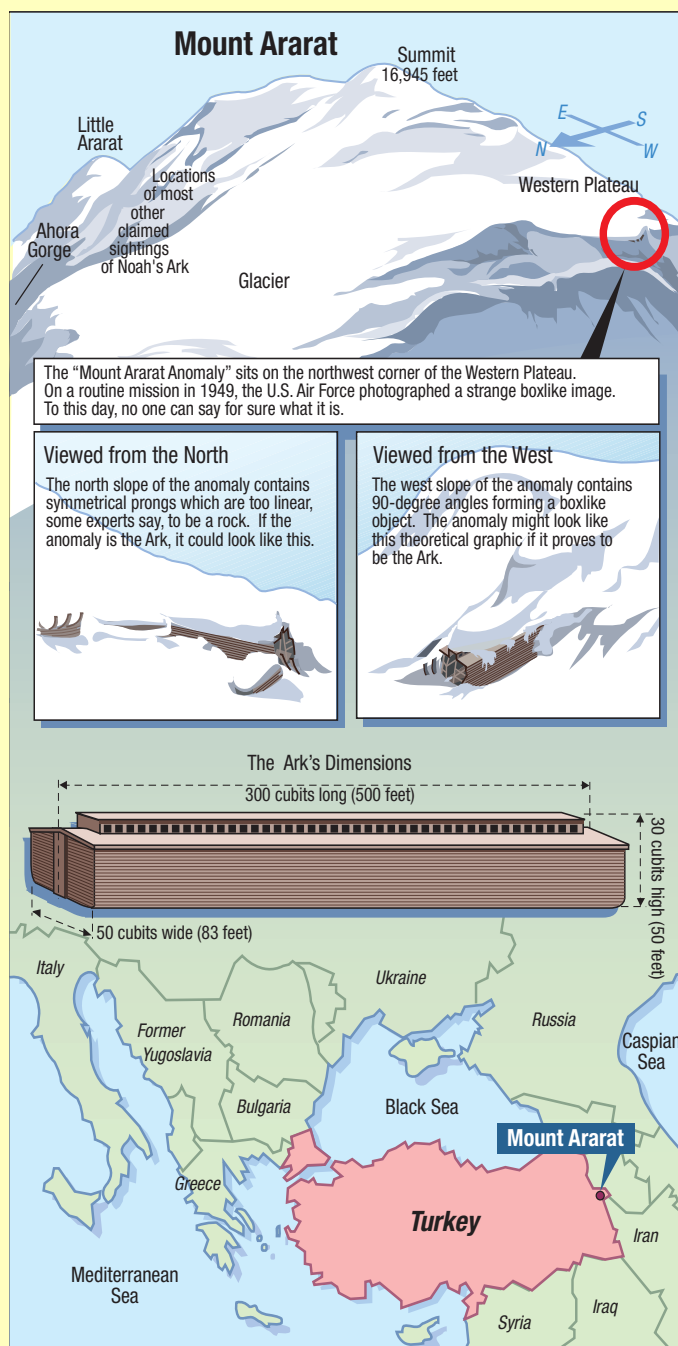

Figure 39: Is the "Ararat Anomaly" Noah's Ark?

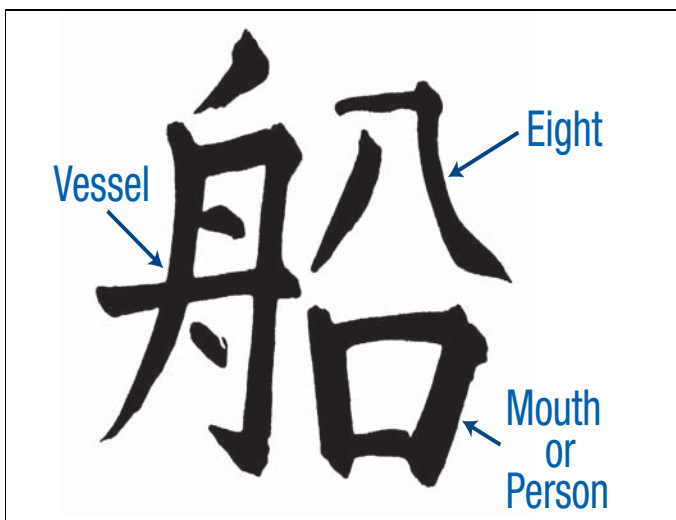

Figure 40: Chinese Word for Boat. Classical Chinese, dating to about 2500 B.C., is one of the oldest languages known. Its “words,” called *pictographs*, are often composed of smaller symbols that themselves have meaning and together tell a story. For example, the classical Chinese word for boat, shown above, is composed of the symbols for “vessel,” “eight,” and “mouth” or “person.” Why would ancient Chinese refer to a boat as “eight-person-vessel”? How many people were on the Ark?

102. Gregor Schwinghammer

Gregor Schwinghammer claims he saw the Ark from an F-100 aircraft in the late 1950s, while assigned to the 428th Tactical Fighter Squadron based in Adana, Turkey. Schwinghammer said it looked like an enormous boxcar lying in a gully high up on Mount Ararat. He said U-2 pilots had photographed it.

Note: Many others claim to have seen the Ark. Some stories are of questionable validity, and others are inconsistent with many known details. Only the most credible reports are summarized above.

Many of the Earth’s Previously Unexplained Features Can Be Explained by a Cataclysmic Flood.

The origin of each of the following is a subject of controversy within the Earth sciences. Each has many aspects inconsistent with standard explanations. Yet, all appear to be consequences of a sudden and unrepeatable event—a cataclysmic flood whose waters erupted from interconnected, worldwide subterranean chambers with an energy release exceeding the explosion of 1,800 trillion hydrogen bombs. Consequences of this event included the rapid formation of the features listed below. The mechanisms involved are well understood.

- 103. The Grand Canyon and Other Canyons
- 104. Mid-Oceanic Ridge

- 105. Earth’s Major Components
- 106. Ocean Trenches, Earthquakes, and the Ring of Fire
- 107. Magnetic Variations on the Ocean Floor
- 108. Submarine Canyons
- 109. Coal and Oil
- 110. Methane Hydrates
- 111. Ice Age
- 112. Frozen Mammoths
- 113. Major Mountain Ranges
- 114. Overthrusts
- 115. Volcanoes and Lava
- 116. Geothermal Heat
- 117. Strata and Layered Fossils
- 118. Limestone
- 119. Metamorphic Rock
- 120. Plateaus
- 121. The Moho and Black Smokers
- 122. Salt Domes
- 123. Jigsaw Fit of the Continents
- 124. Changing Tilt of Earth’s Axis
- 125. Comets
- 126. Asteroids, Meteoroids, and Trans-Neptunian Objects
- 127. Earth’s Radioactivity

For details on the above, see pages 109–433.

The Seemingly Impossible Events of a Worldwide Flood Are Credible, If Examined Closely.

128. Water above Mountains?

Is there enough water to cover all Earth’s preflood mountains in a global flood? Most people do not realize that the volume of water on Earth is ten times greater than the volume of all land above sea level.

Most of Earth’s mountains consist of tipped and buckled sedimentary layers. Because these sediments and the fossils buried in them, were initially laid down through water as nearly horizontal layers, those mountains must have been pushed up after the sediments were deposited. This is why fossils of sea life are on every major mountain range on Earth, including Mount Everest. [See pages 109–151.]

If the effects of compressing the continents and buckling up mountains were reversed, the oceans would again flood the entire Earth. Therefore, the Earth has enough water to cover the smaller mountains that existed before the flood. (If the solid Earth were perfectly smooth, the water depth would be about 9,000 feet everywhere.)

Figure 41: Ark in Football Stadium. This drawing shows how the Ark would fit into a football stadium. The Ark is frequently depicted as a small boat by those who have not bothered to check its dimensions. It was 300 cubits long, 50 cubits wide, and 30 cubits tall. While there were several ancient cubits (generally the distance from a man's elbow to his extended fingers), a cubit was typically 1.5 feet or slightly longer. The 500-foot-long Ark would snugly fit in a football stadium and would be taller than a four-story building.

This sketch of the Ark is based on George Hagopian's credible account (page 46). This Ark does not look like a boat. It has a flat bottom, is not streamlined, and has windows in its top. The flat bottom would have made loading on dry land possible. Streamlined shapes are important only for ships designed for speed and fuel efficiency—neither of which was needed by the Ark. Windows in

the side might be nice for the passengers (or for the proverbial giraffes to stick their necks out), but side windows limit the depth of submergence and the maximum load. Riding low in the water gives a boat great stability. Actually, the Hebrew word for Ark does not mean *boat*; it means *box*, *coffin*, or *chest*—apt descriptions unknown to Hagopian.

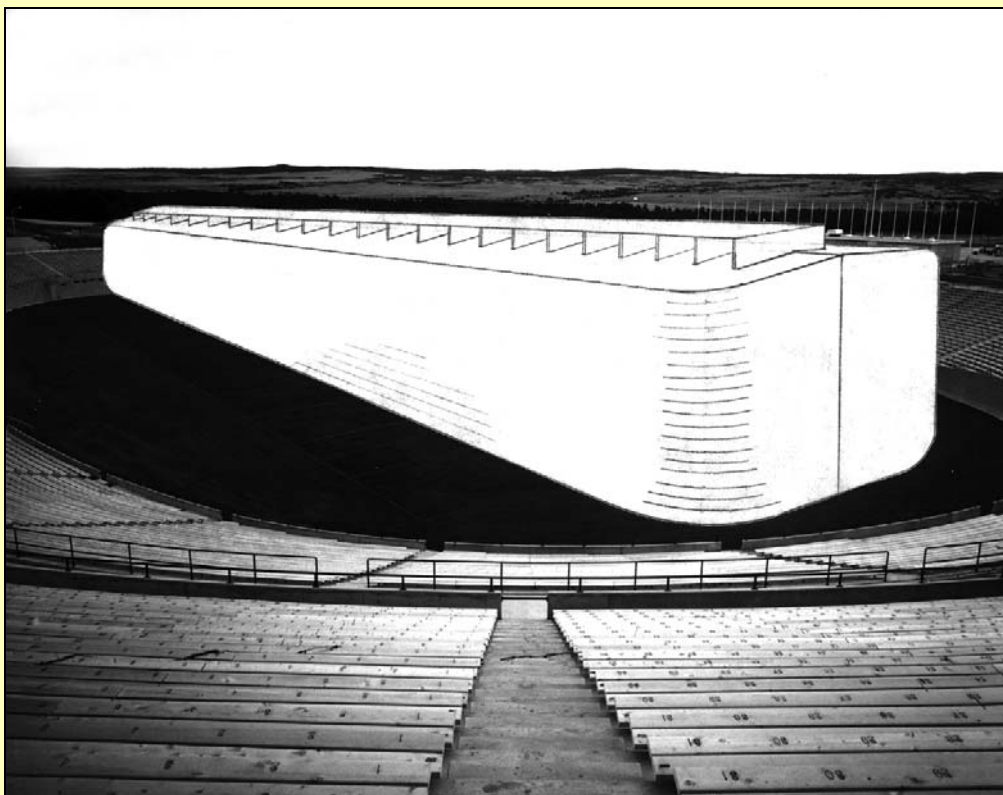

129. Seashells on Mountaintops

Fossilized sea life lies atop every major mountain range on Earth—far above sea level and usually far from the nearest body of water. Attempts to explain “seashells on mountaintops” have generated controversy for centuries.^a

An early explanation was that a global flood covered these mountains, allowing clams and other sea life to “crawl” far and high. However, as Leonardo da Vinci wrote,^b under the best conditions, clams move too slowly to reach such heights, even if the flood lasted centuries. Also, Earth does not have enough water to cover these mountains, so others said that some sea bottoms sank, leaving adjacent seafloors (loaded with sea creatures) relatively high—what we today call mountains. How such large subterranean voids formed to allow this sinking was never explained. Still others proposed that sea bottoms rose to become mountains. The mechanisms, forces, and energy required to push up mountains were also never explained. Because elevations on Earth change slowly, some wondered if sea bottoms could rise miles into the air, perhaps over millions of years. However, mountaintops, which experience destructive freezing and thawing cycles, erode relatively rapidly—and so should fossils slowly

lifted by them. Also, mountaintops accumulate few sediments that might blanket and protect such fossils. Some early authorities, in frustration, said the animals and shells grew inside rocks^c—or the rocks simply look like clams, corals, fish, and ammonites. Others denied the evidence even existed. Today, geologists rarely acknowledge all the seashells on mountaintops.^d

The means by which mountains were pushed up in hours during a global flood will soon be presented. The mechanism is simple, the energy and forces are sufficient, and supporting evidence (pages 109–433) is voluminous—not just seashells on mountaintops.

130. Flood Legends

A gigantic flood may be the most common of all legends. Almost every ancient culture had legends telling of a traumatic flood in which only a few humans survived in a large boat.^a The many common elements in more than 230 flood legends, suggest a common historical event that left a vivid impression on survivors of that catastrophe. This cannot be said for other types of catastrophes, such

as earthquakes, fires, volcanic eruptions, disease, famines, or drought.

131. Was There Room?

Could the Ark have held all the animals? Easily. [See Figure 41.] A small number of humans, some possibly hired, could build a boat^a large enough to hold representatives of every air-breathing land animal—about 16,000 animals in all. Sea creatures did not need to be on the Ark, nor did insects or amphibians. Only mammals, birds, reptiles, and humans. The Ark, having at least 1,500,000 cubic feet of space, was adequate to hold these animals, their provisions, and all their other needs for one year.^b

Since the flood, many offspring of those on the Ark would have become reproductively isolated to some degree due to mutations, natural genetic variations, and geographic dispersion. Thus, variations within a kind have proliferated. Each variation or species we see today did not have to be on the Ark. For example, a few wolflike animals were probably ancestors of the coyotes, dingoes, jackals, and hundreds of varieties of domestic dogs. (This is microevolution, not macroevolution, because each member of the dog kind can interbreed and has the same organs and genetic structure.) Could the Ark have held dinosaurs and elephants? Certainly, if they were young.

What about plants? As the flood began, the powerful fountains of the great deep scattered throughout and even above the atmosphere seeds and spores that settled to earth for years afterward. Fortunately, the 46,000-mile-long fountains were at almost all latitudes. Had they followed an east-west (latitudinal) path, such as along the

preflood equator, many plants we now have would have become extinct. [See pages 111–151 for details.]

This dispersion seems to explain the wide distribution of a few rare plants. As one of several examples—previously explained as “a giant fluke”^c—the same unusual tree is on two tiny, mountainous islands on opposite sides of the globe: the acacia tree on mountains of Réunion Island in the Indian Ocean is genetically identical (except for one mutation) to the koa tree on mountain tops of Kauai, Hawaii. Had the seeds floated in seawater anywhere between those distant islands, they probably would not have germinated.^d Had humans transported the seeds or plants, they should be growing near shorelines, not on mountain tops.^d If a bird transported the seeds, one would not expect the seeds to survive the 11,400-mile journey; either they would have been digested internally, eliminated, or dislodged if carried externally.^e

We have seen evolutionists use the “giant fluke” explanation hundreds of times—disguised in many forms:

- a. “Yes, thousands of components of living things are incredibly complex; each was a giant fluke.”
- b. “Yes, we can’t imagine how xyz could have happened, but over millions of years giant flukes could happen.”
- c. “Yes, what we have discovered in outer space staggers the imagination; it must have followed a big bang—the biggest fluke of all.”

Beware of scientific explanations that are not based on (1) the laws of physics and chemistry, and (2) verifiable, physical evidence (measured or observed). What follows in Part II—an explanation for a catastrophic global flood—fulfills both requirements. The evidence is startling. Read slowly and carefully.

References and Notes for Part I

(To locate specific authors, consult the index.)

1. The Law of Biogenesis

- a. And yet, leading evolutionists are forced to accept some form of spontaneous generation. For example, a former Harvard University professor and Nobel Prize winner in physiology and medicine acknowledged the dilemma.

The reasonable view [during the two centuries before Louis Pasteur] *was to believe in spontaneous generation; the only alternative, to believe in a single, primary act of supernatural creation. There is no third position.* George Wald, “The Origin of Life,” *Scientific American*, Vol. 190, August 1954, p. 46.

Wald rejects creation, despite the impossible odds of spontaneous generation.

One has only to contemplate the magnitude of this task to concede that the spontaneous generation of a living organism is impossible. Yet here we are—as a result, I believe, of spontaneous generation. Ibid.

Later, Wald appeals to huge amounts of time to overcome the “impossibility” of spontaneous generation.

Time is in fact the hero of the plot. ... Given so much time, the “impossible” becomes possible, the possible probable, and the probable virtually certain. One has only to wait: time itself performs the miracles. Ibid., p. 48.

In 1954, when Wald wrote the above, the genetic code had not been discovered. No one could have appreciated just how complex life is. Today, after more discoveries of complexity, the impossibility of spontaneous generation is even more firmly established, regardless of the time available. [See pages 14–23.] Unfortunately, generations of professors and textbooks with Wald’s perspective have so impacted our schools that it is difficult for evolutionists to change direction.

Evolutionists also do not recognize:

- ❖ that with increasing time (their “miracle maker”) comes increasing degradation of the fragile environment on which life depends, and
- ❖ that creationists have much better explanations (such as the flood) for the scientific observations that evolutionists think show vast time periods.

Readers will later see this.

- b. *“The beginning of the evolutionary process raises a question which is as yet unanswerable. What was the origin of life on this planet? Until fairly recent times there was a pretty general belief in the occurrence of ‘spontaneous generation.’ It was supposed that lowly forms of life developed spontaneously from, for example, putrefying meat. But careful experiments, notably those of Pasteur, showed that this conclusion was due to imperfect observation, and it became an accepted doctrine [the law of biogenesis] that life never arises except from life. So far as actual evidence goes, this is still the only possible conclusion. But since it is a conclusion that seems to lead back to some supernatural creative act, it is a conclusion that scientific men find very difficult of acceptance. It carries*

with it what are felt to be, in the present mental climate, undesirable philosophic implications, and it is opposed to the scientific desire for continuity. It introduces an unaccountable break in the chain of causation, and therefore cannot be admitted as part of science unless it is quite impossible to reject it. For that reason most scientific men prefer to believe that life arose, in some way not yet understood, from inorganic matter in accordance with the laws of physics and chemistry.”

J. W. N. Sullivan, *The Limitations of Science* (New York: The Viking Press, Inc., 1933), p. 94.

2. Acquired Characteristics

- a. The false belief that acquired characteristics can be inherited, called *Lamarckism*, would mean that the environment can directly and beneficially change egg and sperm cells. Only a few biologists try to justify Lamarckism. The minor acquired characteristics they cite have no real significance for any present theory of organic evolution. For example, see “Lamarck, Dr. Steel and Plagiarism,” *Nature*, Vol. 337, 12 January 1989, pp. 101–102.
- b. *“This hypothesis* [which Darwin called *pangenesis*] *maintained the idea of inheritance of acquired characteristics.”* A. M. Winchester, *Genetics*, 5th edition (Boston: Houghton Mifflin Co., 1977), p. 24.
- c. In writing about this amazing capability, Queitsch admits:
- ... it is a perplexing evolutionary question how a population might move to a different local optimum without an intervening period of reduced fitness (adaptive valley).* Christine Queitsch et al., “Hsp90 as a Capacitor of Phenotypic Variation,” *Nature*, Vol. 417, 6 June 2002, p. 623.
- d. *“... genes that were switched on in the parent to generate the defensive response are also switched on in the offspring.”* Erkki Haukioja, “Bite the Mother, Fight the Daughter,” *Nature*, Vol. 401, 2 September 1999, p. 23.
- ◆ *“... non-lethal exposure of an animal to carnivores, and a plant to a herbivore, not only induces a defence, but causes the attacked organisms to produce offspring that are better defended than offspring from unthreatened parents.”* Anurag A. Agrawal et al., “Transgenerational Induction of Defences in Animals and Plants,” *Nature*, Vol. 401, 2 September 1999, p. 60.
 - ◆ *“... hidden genetic diversity exists within species and can erupt when [environmental] conditions change.”* John Travis, “Evolutionary Shocker?: Stressful Conditions May Trigger Plants and Animals to Unleash New Forms Quickly,” *Science News*, Vol. 161, 22 June 2002, p. 394.
 - ◆ *“Environmental stress can reveal genetic variants, presumably because it compromises buffering systems. If selected for, these uncovered phenotypes can lead to heritable changes in plants and animals (assimilation).”* Queitsch et al., p. 618.

- e. Marina Chicurel, "Can Organisms Speed Their Own Evolution?" *Science*, Vol. 292, 8 June 2001, pp. 1824–1827.

3. Mendel's Laws

- a. Monroe W. Strickberger, *Genetics*, 2nd edition (New York: Macmillan Publishing Co., 1976), p. 812.
- ◆ Alfred Russel Wallace, who independently proposed the theory of organic evolution 4 years before Charles Darwin, was opposed to Mendel's laws of genetics. Wallace knew Mendel's experiments showed that the general characteristics of an organism remained within distinct boundaries. In a letter to Dr. Archdall Reid on 28 December 1909, Wallace wrote:

But on the general relation of Mendelism to Evolution, I have come to a very definite conclusion. This is, that it has no relation whatever to the evolution of species or higher groups, but is really antagonistic to such evolution! The essential basis of evolution, involving as it does the most minute and all-pervading adaptation to the whole environment, is extreme and ever-present plasticity, as a condition of survival and adaptation. But the essence of Mendelian characters is their rigidity. They are transmitted without variation, and therefore, except by the rarest of accidents, can never become adapted to ever varying conditions. James Marchant, *Alfred Russel Wallace: Letters and Reminiscences* (New York: Harper & Brothers, 1916), p. 340.
 - b. "Every series of breeding experiments that has ever taken place has established a finite limit to breeding possibilities." Francis Hitching, *The Neck of the Giraffe: Where Darwin Went Wrong* (New Haven, Connecticut: Ticknor and Fields, 1982), p. 55.
 - ◆ "All competent biologists acknowledge the limited nature of the variation breeders can produce, although they do not like to discuss it much when grinding the evolutionary ax." William R. Fix, *The Bone Peddlers: Selling Evolution* (New York: Macmillan Publishing Co., 1984), pp. 184–185.
 - ◆ "A rule that all breeders recognize, is that there are fixed limits to the amount of change that can be produced." Lane P. Lester and Raymond G. Bohlin, *The Natural Limits to Biological Change* (Grand Rapids: Zondervan Publishing House, 1984), p. 96.
 - ◆ Norman Macbeth, *Darwin Retried: An Appeal to Reason* (Ipswich, Massachusetts: Gambit, 1971), p. 36.
 - ◆ William J. Tinkle, *Heredity* (Houston: St. Thomas Press, 1967), pp. 55–56.
 - c. "... the distinctions of specific forms and their not being blended together by innumerable transitional links, is a very obvious difficulty." Charles Darwin, *The Origin of Species*, 6th edition (New York: Macmillan Publishing Co., 1927), p. 322.
 - ◆ "Indeed, the isolation and distinctness of different types of organisms and the existence of clear discontinuities in nature have been self-evident for centuries, even to non-biologists." Michael Denton, *Evolution: A Theory in Crisis* (London: Burnett Books, 1985), p. 105.

4. Bounded Variations

- a. "... the discovery of the Danish scientist W. L. Johannsen that the more or less constant somatic variations, upon which Darwin and Wallace had placed their emphasis in species change, cannot be selectively pushed beyond a certain point, that such variability does not contain the secret of 'indefinite departure.'" Loren Eiseley, *Darwin's Century* (Garden City, New York: Doubleday & Co., Inc., 1958), p. 227.
- b. "The awesome morphological complexity of organisms such as vertebrates that have far fewer individuals on which selection can act therefore remains somewhat puzzling (for me at least), despite the geological time scales available ..." Peter R. Sheldon, "Complexity Still Running," *Nature*, Vol. 350, 14 March 1991, p. 104.
- c. Bland J. Finlay, "Global Dispersal of Free-Living Microbial Eukaryote Species," *Science*, Vol. 296, 10 May 2002, pp. 1061–1063.

5. Natural Selection

- a. In 1835 and again in 1837, Edward Blyth, a creationist, published an explanation of natural selection. Later, Charles Darwin adopted it as the foundation for his theory, evolution by natural selection. Darwin failed to credit Blyth for his important insight. [See evolutionist Loren C. Eiseley, *Darwin and the Mysterious Mr. X* (New York: E. P. Dutton, 1979), pp. 45–80.]

Darwin also largely ignored Alfred Russel Wallace, who had independently proposed the theory that is usually credited solely to Darwin. In 1855, Wallace published the theory of evolution in a brief note in the *Annals and Magazine of Natural History*, a note that Darwin read. Again, on 9 March 1858, Wallace explained the theory in a letter to Darwin, 20 months before Darwin finally published his more detailed theory of evolution.

Edward Blyth also showed why natural selection would limit an organism's characteristics to only slight deviations from those of all its ancestors. Twenty-four years later, Darwin tried to refute Blyth's explanation in a chapter in *The Origin of Species by Means of Natural Selection* (24 November 1859).

Darwin felt that, with enough time, gradual changes could accumulate. Charles Lyell's writings (1830) had persuaded Darwin that the Earth was at least hundreds of thousands of years old. James Hutton's writings (1788) had convinced Lyell that the Earth was extremely old. Hutton felt that certain geological formations supported an old Earth. Those geological formations are explained, not by time, but by a global flood. [See pages 109–374.]

- ◆ "Darwin was confronted by a genuinely unusual problem. The mechanism, natural selection, by which he hoped to prove the reality of evolution, had been written about most intelligently by a nonevolutionist [Edward Blyth]. *Geology, the time world which it was necessary to attach to natural selection in order to produce [hopefully] the mechanism of*

organic change, had been beautifully written upon by a man [Charles Lyell] who had publicly repudiated the evolutionary position.” Eiseley, p. 76.

- ◆ Charles Darwin also plagiarized in other instances. [See Jerry Bergman, “Did Darwin Plagiarize His Evolution Theory?” *Technical Journal*, Vol. 16, No. 3, 2002, pp. 58–63.]
- b. “[Natural selection] *may have a stabilizing effect, but it does not promote speciation. It is not a creative force as many people have suggested.*” Daniel Brooks, as quoted by Roger Lewin, “A Downward Slope to Greater Diversity,” *Science*, Vol. 217, 24 September 1982, p. 1240.
- ◆ “*The essence of Darwinism lies in a single phrase: natural selection is the creative force of evolutionary change. No one denies that natural selection will play a negative role in eliminating the unfit. Darwinian theories require that it create the fit as well.*” Stephen Jay Gould, “The Return of Hopeful Monsters,” *Natural History*, Vol. 86, June–July 1977, p. 28.
- c. G. Z. Opatia-Kadima, “How the Slot Machine Led Biologists Astray,” *Journal of Theoretical Biology*, Vol. 124, 1987, pp. 127–135.
- d. Eric Penrose, “Bacterial Resistance to Antibiotics—A Case of *Un-Natural Selection*,” *Creation Research Society Quarterly*, Vol. 35, September 1998, pp. 76–83.
- e. Well-preserved bodies of members of the Franklin expedition, frozen in the Canadian Arctic in 1845, contain bacteria resistant to antibiotics. Because the first antibiotics were developed in the early 1940s, these resistant bacteria could not have evolved in response to antibiotics. Contamination has been eliminated as a possibility. [See Rick McGuire, “Eerie: Human Arctic Fossils Yield Resistant Bacteria,” *Medical Tribune*, 29 December 1988, p. 1.]
- ◆ “*The genetic variants required for resistance to the most diverse kinds of pesticides were apparently present in every one of the populations exposed to these man-made compounds.*” Francisco J. Ayala, “The Mechanisms of Evolution,” *Scientific American*, Vol. 239, September 1978, p. 65.
- f. “*Darwin complained his critics did not understand him, but he did not seem to realize that almost everybody, friends, supporters and critics, agreed on one point, his natural selection cannot account for the origin of the variations, only for their possible survival. And the reasons for rejecting Darwin’s proposal were many, but first of all that many innovations cannot possibly come into existence through accumulation of many small steps, and even if they can, natural selection cannot accomplish it, because incipient and intermediate stages are not advantageous.*” Søren Løvtrup, *Darwinism: The Refutation of a Myth* (New York: Croom Helm, 1987), pp. 274–275.
- ◆ “*It was a shock to the people of the 19th century when they discovered, from observations science had made, that many features of the biological world could be ascribed to the elegant principle of natural selection. It is a shock to us in the twentieth century to discover, from observations science has made, that the fundamental mechanisms of life cannot be ascribed to natural selection, and therefore were designed.*

But we must deal with our shock as best we can and go on. The theory of undirected evolution is already dead, but the work of science continues.” Michael J. Behe, “Molecular Machines,” *Cosmic Pursuit*, Spring 1998, p. 35.

- g. In 1980, the “Macroevolution Conference” was held in Chicago. Roger Lewin, writing for *Science*, described it as a “*turning point in the history of evolutionary theory.*” Summarizing a range of opinions, he said:

The central question of the Chicago conference was whether the mechanisms underlying microevolution can be extrapolated to explain the phenomena of macroevolution. At the risk of doing violence to the positions of some of the people at the meeting, the answer can be given as a clear, No. Roger Lewin, “Evolution Theory under Fire,” *Science*, Vol. 210, 21 November 1980, p. 883.

“In a generous admission Francisco Ayala, a major figure in propounding the Modern Synthesis [neo-Darwinism] in the United States, said ‘We would not have predicted stasis [the stability of species over time] from population genetics, but I am now convinced from what the paleontologists say that small changes do not accumulate.’” Ibid., p. 884.

“But the crucial issue is that, for the most part, the fossils do not document a smooth transition from old morphologies to new ones.” Ibid., p. 883.

Since the fossil record does not show small, continual changes that build up over time to produce macroevolution (as has been taught for over a century), the conclusion was that macroevolutionary jumps must be relatively sudden. If so, how could those major jumps produce an organism with a new vital organ? Without that vital organ, the creature is, by definition, dead.

As stated earlier, micro + time ≠ macro.

- ◆ “*One could argue at this point that such ‘minor’ changes [microevolution], extrapolated over millions of years, could result in macroevolutionary change. But the observational evidence will not support this argument ... [examples given] Thus, the changes observed in the laboratory are not analogous to the sort of changes needed for macroevolution. Those who argue from microevolution to macroevolution may be guilty, then, of employing a false analogy—especially when one considers that microevolution may be a force of stasis [stability], not transformation. ... For those who must describe the history of life as a purely natural phenomenon, the winnowing action of natural selection is truly a difficult problem to overcome. For scientists who are content to describe accurately those processes and phenomena which occur in nature (in particular, stasis), natural selection acts to prevent major evolutionary change.*” Michael Thomas, “Stasis Considered,” *Origins Research*, Vol. 12, Fall/Winter 1989, p. 11.

6. Mutations

- a. “*Ultimately, all variation is, of course, due to mutation.*” Ernst Mayr, “Evolutionary Challenges to the Mathematical Interpretation of Evolution,” *Mathematical Challenges to*

- the Neo-Darwinian Interpretation of Evolution*, editors Paul S. Moorhead and Martin M. Kaplan, proceedings of a symposium held at the Wistar Institute of Anatomy and Biology, 25–26 April, 1966 (Philadelphia: The Wistar Institute Press, 1967), p. 50.
- ◆ “Although mutation is the ultimate source of all genetic variation, it is a relatively rare event, ...” Ayala, p. 63.
 - b. “The process of mutation is the only known source of the raw materials of genetic variability, and hence of evolution. ... the mutants which arise are, with rare exceptions, deleterious to their carriers, at least in the environments which the species normally encounters.” Theodosius Dobzhansky, “On Methods of Evolutionary Biology and Anthropology,” *American Scientist*, December 1957, p. 385.
 - ◆ “In molecular biology, various kinds of mutations introduce the equivalent of noise pollution of the original instructive message. Communication theory goes to extraordinary lengths to prevent noise pollution of signals of all kinds. Given this longstanding struggle against noise contamination of meaningful algorithmic messages, it seems curious that the central paradigm of biology today attributes genomic messages themselves solely to noise.” David L. Abel and Jack T. Trevors, “Three Subsets of Sequence Complexity and Their Relevance to Biopolymeric Information,” *Theoretical Biology & Medical Modelling*, Vol. 2, 11 August 2005, p. 10. (Also available at www.tbiomed.com/content/2/1/29.)
 - ◆ “Accordingly, mutations are more than just sudden changes in heredity; they also affect viability, and, to the best of our knowledge, invariably affect it adversely.” C. P. Martin, “A Non-Geneticist Looks at Evolution,” *American Scientist*, January 1953, p. 102.
- “Mutation does produce hereditary changes, but the mass of evidence shows that all, or almost all, known mutations are unmistakably pathological and the few remaining ones are highly suspect.” *Ibid.*, p. 103.
- “[Although mutations have produced some desirable breeds of animals and plants,] all mutations seem to be in the nature of injuries that, to some extent, impair the fertility and viability of the affected organisms. I doubt if among the many thousands of known mutant types one can be found which is superior to the wild type in its normal environment, only very few can be named which are superior to the wild type in a strange environment.” *Ibid.*, p. 100.
 - ◆ “If we say that it is only by chance that they [mutations] are useful, we are still speaking too leniently. In general, they are useless, detrimental, or lethal.” W. R. Thompson, “Introduction to *The Origin of Species*,” Everyman Library No. 811 (New York: E. P. Dutton & Sons, 1956; reprint, Sussex, England: J. M. Dent and Sons, Ltd., 1967), p. 10.
 - ◆ Visible mutations are easily detectable genetic changes, such as albinism, dwarfism, and hemophilia. Winchester quantifies the relative frequency of several types of mutations. *Lethal mutations outnumber visibles by about 20 to 1. Mutations that have small harmful effects, the detrimental mutations, are even more frequent than the lethal ones.* Winchester, p. 356.
 - ◆ John W. Klotz, *Genes, Genesis, and Evolution*, 2nd edition, revised (St. Louis: Concordia Publishing House, 1972), pp. 262–265.
 - ◆ “... I took a little trouble to find whether a single amino acid change in a hemoglobin mutation is known that doesn't affect seriously the function of that hemoglobin. One is hard put to find such an instance.” George Wald, as quoted by Murray Eden, “Inadequacies of Neo-Darwinian Evolution as a Scientific Theory,” *Mathematical Challenges to the Neo-Darwinian Interpretation of Evolution*, editors Paul S. Moorhead and Martin M. Kaplan, pp. 18–19.

However, evolutionists have taught for years that hemoglobin alpha changed through mutations into hemoglobin beta. This would require, at a minimum, 120 point mutations, so the improbability Wald refers to above must be raised to the 120th power to produce just this one protein!

 - ◆ “Even if we didn't have a great deal of data on this point, we could still be quite sure on theoretical grounds that mutants would usually be detrimental. For a mutation is a random change of a highly organized, reasonably smoothly functioning living body. A random change in the highly integrated system of chemical processes which constitute life is almost certain to impair it—just as a random interchange of connections in a television set is not likely to improve the picture.” James F. Crow (Professor of Genetics, University of Wisconsin), “Genetic Effects of Radiation,” *Bulletin of the Atomic Scientists*, Vol. 14, January 1958, pp. 19–20.
 - ◆ “The one **systematic** effect of mutation seems to be a tendency towards degeneration ...” [emphasis in original] Sewall Wright, “The Statistical Consequences of Mendelian Heredity in Relation to Speciation,” *The New Systematics*, editor Julian Huxley (London: Oxford University Press, 1949), p. 174.

Wright then concludes that other factors must also have been involved, because he believes evolution happened.

 - ◆ In discussing the many mutations needed to produce a new organ, Koestler says:

Each mutation occurring alone would be wiped out before it could be combined with the others. They are all interdependent. The doctrine that their coming together was due to a series of blind coincidences is an affront not only to common sense but to the basic principles of scientific explanation. Arthur Koestler, *The Ghost in the Machine* (New York: Macmillan Publishing Co., 1968), p. 129.
 - c. “There is no single instance where it can be maintained that any of the mutants studied has a higher vitality than the mother species.” N. Heribert Nilsson, *Synthetische Artbildung* (Lund, Sweden: Verlag CWK Gleerup, 1953), p. 1157.

“It is, therefore, absolutely impossible to build a current evolution on mutations or on recombinations.” [emphasis in original] *Ibid.*, p. 1186.

- ◆ “No matter how numerous they may be, mutations do not produce any kind of evolution.” Pierre-Paul Grassé, *Evolution of Living Organisms* (New York: Academic Press, 1977), p. 88.
 - ◆ “I have seen no evidence whatsoever that these [evolutionary] changes can occur through the accumulation of gradual mutations.” Lynn Margulis, as quoted by Charles Mann, “Lynn Margulis: Science’s Unruly Earth Mother,” *Science*, Vol. 252, 19 April 1991, p. 379.
 - ◆ “It is true that nobody thus far has produced a new species or genus, etc., by macromutation. It is equally true that nobody has produced even a species by the selection of micromutations.” Richard B. Goldschmidt, “Evolution, As Viewed by One Geneticist,” *American Scientist*, Vol. 40, January 1952, p. 94.
 - ◆ “If life really depends on each gene being as unique as it appears to be, then it is too unique to come into being by chance mutations.” Frank B. Salisbury, “Natural Selection and the Complexity of the Gene,” *Nature*, Vol. 224, 25 October 1969, p. 342.
 - ◆ “Do we, therefore, ever see mutations going about the business of producing new structures for selection to work on? No nascent organ has ever been observed emerging, though their origin in pre-functional form is basic to evolutionary theory. Some should be visible today, occurring in organisms at various stages up to integration of a functional new system, but we don’t see them: there is no sign at all of this kind of radical novelty. Neither observation nor controlled experiment has shown natural selection manipulating mutations so as to produce a new gene, hormone, enzyme system or organ.” Michael Pitman, *Adam and Evolution* (London: Rider & Co., 1984), pp. 67–68.
- d. For a multifaceted genetic analysis that devastates the idea that mutations and natural selection can produce, or even maintain, viable organisms, see John C. Sanford, *Genetic Entropy & the Mystery of the Genome* (Waterloo, New York: FMS Publications, 2005).

7. Fruit Flies

- a. “Most mutants which arise in any organism are more or less disadvantageous to their possessors. The classical mutants obtained in *Drosophila* [the fruit fly] usually show deterioration, breakdown, or disappearance of some organs. Mutants are known which diminish the quantity or destroy the pigment in the eyes, and in the body reduce the wings, eyes, bristles, legs. Many mutants are, in fact, lethal to their possessors. Mutants which equal the normal fly in vigor are a minority, and mutants that would make a major improvement of the normal organization in the normal environments are unknown.” Theodosius Dobzhansky, *Evolution, Genetics, and Man* (New York: John Wiley & Sons, 1955), p. 105.
- ◆ “A review of known facts about their [mutated fruit flies] ability to survive has led to no other conclusion than that they are always constitutionally weaker than their parent form or species, and in a population with free competition they are eliminated. Therefore they are never found in nature (e.g., not a single one of the several hundreds of *Drosophila* mutations), and therefore they are able to appear only in the favourable environment of the experimental field or laboratory ...” Nilsson, p. 1186.
- ◆ “In the best-known organisms, like *Drosophila*, innumerable mutants are known. If we were able to combine a thousand or more of such mutants in a single individual, this still would have no resemblance whatsoever to any type known as a [new] species in nature.” Goldschmidt, p. 94.
- ◆ “It is a striking, but not much mentioned fact that, though geneticists have been breeding fruit-flies for sixty years or more in labs all round the world—flies which produce a new generation every eleven days—they have never yet seen the emergence of a new species or even a new enzyme.” Gordon Rattray Taylor (former Chief Science Advisor, BBC Television), *The Great Evolution Mystery* (New York: Harper & Row, 1983), p. 48.
- ◆ “Fruit flies refuse to become anything but fruit flies under any circumstances yet devised.” Hitching, p. 61.
- ◆ “The fruitfly (*Drosophila melanogaster*), the favorite pet insect of the geneticists, whose geographical, biotopical, urban, and rural genotypes are now known inside out, seems not to have changed since the remotest times.” Grassé, p. 130.

8. Complex Molecules and Organs

- a. “There has never been a meeting, or a book, or a paper on details of the evolution of complex biochemical systems.” Michael J. Behe, *Darwin’s Black Box* (New York: The Free Press, 1996), p. 179.
- ◆ “Molecular evolution is not based on scientific authority. There is no publication in the scientific literature—in prestigious journals, specialty journals, or book—that describes how molecular evolution of any real, complex, biochemical system either did occur or even might have occurred. There are assertions that such evolution occurred, but absolutely none are supported by pertinent experiments or calculations. Since no one knows molecular evolution by direct experience, and since there is no authority on which to base claims of knowledge, it can truly be said that—like the contention that the Eagles will win the Super Bowl this year—the assertion of Darwinian molecular evolution is merely bluster.” Behe, pp. 186–187.
- b. “While today’s digital hardware is extremely impressive, it is clear that the human retina’s real-time performance goes unchallenged. Actually, to simulate 10 milliseconds (ms) of the complete processing of even a single nerve cell from the retina would require the solution of about 500 simultaneous nonlinear differential equations 100 times and would take at least several minutes of processing time on a Cray supercomputer. Keeping in mind that there are 10 million or more such cells interacting with each other in complex ways, it would take a minimum of 100 years of [1985] Cray time to simulate what takes place in your eye many times every second.” John K. Stevens, “Reverse Engineering the Brain,” *Byte*, April 1985, p. 287.
- ◆ “The retina processes information much more than anyone has ever imagined, sending a dozen different movies to the brain.” Frank Werblin and Botond Roska, “The Movies in Our Eyes,” *Scientific American*, Vol. 296, April 2007, p. 73.

- ◆ “*Was the eye contrived without skill in opticks [optics], and the ear without knowledge of sounds?*” Isaac Newton, *Opticks* (England: 1704; reprint, New York: McGraw-Hill, 1931), pp. 369–370.
 - ◆ “*Certainly there are those who argue that the universe evolved out of a random process, but what random process could produce the brain of a man or the system of the human eye?*” Wernher von Braun (probably the rocket scientist most responsible for the United States’ success in placing men on the Moon) from a letter written by Dr. Wernher von Braun and read to the California State Board of Education by Dr. John Ford on 14 September 1972.
 - ◆ “*What random process could possibly explain the simultaneous evolution of the eye’s optical system, the nervous conductors of the optical signals from the eye to the brain, and the optical nerve center in the brain itself where the incoming light impulses are converted to an image the conscious mind can comprehend?*” Wernher von Braun, foreword to *From Goo to You by Way of the Zoo* by Harold Hill (Plainfield, New Jersey: Logos International, 1976), p. xi.
 - ◆ “*The probability of dust carried by the wind reproducing Dürer’s ‘Melancholia’ is less infinitesimal than the probability of copy errors in the DNA molecule leading to the formation of the eye; besides, these errors had no relationship whatsoever with the function that the eye would have to perform or was starting to perform. There is no law against daydreaming, but science must not indulge in it.*” [emphasis in original] Grassé, p. 104.
 - ◆ “*It must be admitted, however, that it is a considerable strain on one’s credulity to assume that finely balanced systems such as certain sense organs (the eye of vertebrates, or the bird’s feather) could be improved by random mutations. This is even more true for some of the ecological chain relationships (the famous yucca moth case, and so forth). However, the objectors to random mutations have so far been unable to advance any alternative explanation that was supported by substantial evidence.*” Ernst Mayr, *Systematics and the Origin of Species* (New York: Dover Publications, 1942), p. 296.
 - ◆ Although Robert Jastrow generally accepts Darwinian evolution, he acknowledges that:

It is hard to accept the evolution of the human eye as a product of chance; it is even harder to accept the evolution of human intelligence as the product of random disruptions in the brain cells of our ancestors.

 Robert Jastrow, “Evolution: Selection for Perfection,” *Science Digest*, December 1981, p. 87.
 - ◆ Many leading scientists have commented on the staggering complexity of the human eye. What some do not appreciate is how many diverse types of eyes there are, each of which adds to the problem for evolution.
 - ❖ One of the strangest is a multiple-lensed compound eye found in fossilized worms! [See Donald G. Mikulic et al., “A Silurian Soft-Bodied Biota,” *Science*, Vol. 228, 10 May 1985, pp. 715–717.]
 - ❖ Another type of eye belonged to some trilobites, a thumb-size, extinct, sea-bottom creature. Evolutionists claim that they were very early forms of life. Trilobite eyes had **compound lenses**, sophisticated designs for eliminating image distortion (spherical aberration). Only the best cameras and telescopes contain compound lenses. Some trilobite eyes contained 280 lenses, allowing vision in all directions, day and night. [See Richard Fortey and Brian Chatterton, “A Devonian Trilobite with an Eyeshade,” *Science*, Vol. 301, 19 September 2003, p. 1689.] Trilobite eyes “*represent an all-time feat of function optimization.*” [Riccardo Levi-Setti, *Trilobites*, 2nd edition (Chicago: The University of Chicago Press, 1993), p. 29.] Shawver described trilobite eyes as having “*the most sophisticated eye lenses ever produced by nature.*” [Lisa J. Shawver, “Trilobite Eyes: An Impressive Feat of Early Evolution,” *Science News*, Vol. 105, 2 February 1974, p. 72.] Gould admitted that “*The eyes of early trilobites, for example, have never been exceeded for complexity or acuity by later arthropods. ... I regard the failure to find a clear ‘vector of progress’ in life’s history as the most puzzling fact of the fossil record.*” [Stephen Jay Gould, “The Ediacaran Experiment,” *Natural History*, Vol. 93, February 1984, pp. 22–23.]
 - ❖ The brittlestar, an animal similar to a 5-arm starfish, has, as part of its skeleton, thousands of eyes, each smaller than the diameter of a human hair. Each eye consists of a calcium carbonate crystal that acts as a compound lens and precisely focuses light on a bundle of nerves. If an arm is lost, a new arm regenerates along with its array of eyes mounted on the upper-back side of the arm. While evolutionists had considered these animals primitive, Sambles admits that “*Once again we find that nature foreshadowed our technical developments.*” Roy Sambles, “Armed for Light Sensing,” *Nature*, Vol. 412, 23 August 2001, p. 783. The capabilities of these light-focusing lenses exceed today’s technology.
 - c. “*To my mind the human brain is the most marvelous and mysterious object in the whole universe and no geologic period seems too long to allow for its natural evolution.*” Henry Fairfield Osborn, an influential evolutionist speaking to the American Association for the Advancement of Science in December 1929, as told by Roger Lewin, *Bones of Contention* (New York: Simon and Schuster, Inc., 1987), p. 57. [Even greater capabilities of the brain have been discovered since 1929. Undoubtedly, more remain.]
 - ◆ “*And in Man is a three-pound brain which, as far as we know, is the most complex and orderly arrangement of matter in the universe.*” Isaac Asimov, “In the Game of Energy and Thermodynamics You Can’t Even Break Even,” *Smithsonian*, August 1970, p. 10.
- Asimov seems to have forgotten that the brain, and presumably most of its details, is coded by only a fraction of an individual’s DNA. Therefore, it would be more accurate to say that DNA is the most complex and orderly arrangement of matter known in the universe.
- ◆ The human brain is frequently likened to a supercomputer. In most respects, the brain greatly exceeds any computer’s capabilities. Speed is one area where the computer beats the brain—at least in some ways. For example, few of us can

quickly multiply numbers such as 0.0239 times 854.95. This task is called a *floating point operation*, because the decimal point “floats” until we (or a computer) decide where to place it. The number of Floating Point Operations Per Second (FLOPS) is a measure of a computer’s speed. As of 2018, Summit, the world’s most powerful supercomputer, which was developed at Oak Ridge National Laboratory in Tennessee, holds the record at 200,000 trillion FLOPS (200 petaFLOPS)— millions of times faster than a standard laptop! One challenge is to prevent these superfast computers from overheating, because too much electrically generated heat is dissipated in too small a volume.

- ◆ Our brains operate at petaFLOPS speeds—without overheating. One knowledgeable observer on these ultrafast computers commented:

The human brain itself serves, in some sense, as a proof of concept [that cool petaFLOPS machines are possible]. Its dense network of neurons apparently operates at a petaFLOPS or higher level. Yet the whole device fits in a 1 liter box and uses only about 10 watts of power. That’s a hard act to follow. Ivars Peterson, “PetaCrunchers: Setting a Course toward Ultrafast Supercomputing,” *Science News*, Vol. 147, 15 April 1995, p. 235.

Also, the 1,400 cubic centimeter (3 pound) human brain is more than three times larger than that of a chimpanzee, and when adjusted for body weight and size, larger than that of any other animal. How, then, could the brain have evolved? Why haven’t more animals evolved large, “petaFLOP” brains?

- d. *“The human brain consists of about ten thousand million nerve cells. Each nerve cell puts out somewhere in the region of between ten thousand and one hundred thousand connecting fibers by which it makes contact with other nerve cells in the brain. Altogether the total number of connections in the human brain approaches 10^{15} or a thousand million million. ... a much greater number of specific connections than in the entire communications network on Earth.”* Denton, pp. 330–331.
- ◆ A more recent neuron estimate for humans is at least 85 billion. [See “Understanding Memory” *Science News*, 19 March 2016, p. 4.]
- ◆ *“... the human brain probably contains more than 10^{14} synapses ...”* Deborah M. Barnes, “Brain Architecture: Beyond Genes,” *Science*, Vol. 233, 11 July 1986, p. 155.
- e. Marlyn E. Clark, *Our Amazing Circulatory System*, Technical Monograph No. 5 (San Diego: Creation-Life Publishers, 1976).

9. Fully-Developed Organs

- a. William Paley, *Natural Theology* (England: 1802; reprint, Houston: St. Thomas Press, 1972).

This work by Paley, which contains many powerful arguments for a Creator, is a classic in scientific literature. Some might feel that because it was written in 1802, it is out of date. Not so. Hoyle and Wickramasinghe compared Darwin’s ideas with those of Paley as follows:

*The speculations of **The Origin of Species** turned out to be wrong, as we have seen in this chapter. It is*

ironic that the scientific facts throw Darwin out, but leave William Paley, a figure of fun to the scientific world for more than a century, still in the tournament with a chance of being the ultimate winner. Fred Hoyle and N. Chandra Wickramasinghe, *Evolution from Space: A Theory of Cosmic Creationism* (New York: Simon and Schuster, 1981), pp. 96–97.

- b. Asa Gray, a famous Harvard botany professor, who became a leading theistic evolutionist, wrote to Darwin expressing doubt that natural processes could explain the formation of complex organs, such as the eye. Darwin expressed a similar concern in his return letter of February 1860.

The eye to this day gives me a cold shudder, but when I think of the fine known gradations [Darwin believed possible if millions of years of evolution were available], my reason tells me I ought to conquer the cold shudder. Charles Darwin, *The Life and Letters of Charles Darwin*, Vol. 2, editor Francis Darwin (New York: D. Appleton and Co., 1899), pp. 66–67.

And yet, Darwin admitted that:

To suppose that the eye with all its inimitable contrivances for adjusting the focus to different distances, for admitting different amounts of light, and for the correction of spherical and chromatic aberration, could have been formed by natural selection, seems, I freely confess, absurd in the highest degree. Charles Darwin, *The Origin of Species*, p. 175.

Darwin then speculated on how the eye might have evolved. However, no evidence was given. Later, he explained how his theory could be falsified.

If it could be demonstrated that any complex organ existed which could not possibly have been formed by numerous, successive, slight modifications, my theory would absolutely break down. Charles Darwin, *The Origin of Species*, p. 179.

- ◆ *“It’s one of the oldest riddles in evolutionary biology: How does natural selection gradually create an eye, or any complex organ for that matter? The puzzle troubled Charles Darwin, who nevertheless gamely nailed together a ladder of how it might have happened—from photoreceptor cells to highly refined orbits—by drawing examples from living organisms such as mollusks and arthropods. But holes in this progression have persistently bothered evolutionary biologists and left openings that creationists have been only too happy to exploit.”* Virginia Morell, “Placentas May Nourish Complexity Studies,” *Science*, Vol. 298, 1 November 2002, p. 945.

David Reznick, an evolutionary biologist at the University of California (Riverside), explained to Virginia Morell:

Darwin had to use organisms from different classes, because there isn’t a living group of related organisms that have all the steps for making an eye. Ibid.

To solve this dilemma, Reznick points to different species of a guppylike fish, some of which have no placenta and others that have *“tissues that might become placentas.”* However, when pressed, *“Reznick admits that the [guppylike fish’s] placenta might not be as sophisticated as the mammalian placenta”* [or the eye of any organism]. Ibid.

- ◆ “The eye, as one of the most complex organs, has been the symbol and archetype of his [Darwin’s] dilemma. Since the eye is obviously of no use at all except in its final, complete form, how could natural selection have functioned in those initial stages of its evolution when the variations had no possible survival value? No single variation, indeed no single part, being of any use without every other, and natural selection presuming no knowledge of the ultimate end or purpose of the organ, the criterion of utility, or survival, would seem to be irrelevant. And there are other equally provoking examples of organs and processes which seem to defy natural selection. Biochemistry provides the case of chemical synthesis built up in several stages, of which the intermediate substance formed at any one stage is of no value at all, and only the end product, the final elaborate and delicate machinery, is useful—and not only useful but vital to life. How can selection, knowing nothing of the end or final purpose of this process, function when the only test is precisely that end or final purpose?” Gertrude Himmelfarb, *Darwin and the Darwinian Revolution* (Garden City, New York: Doubleday, 1959), pp. 320–321.
- c. “Of what possible use are the imperfect incipient stages of useful structures? What good is half a jaw or half a wing?” Stephen Jay Gould, “The Return of Hopeful Monsters,” p. 23.

10. Distinct Types

- a “[Contrary to Darwin and generations of subsequent evolutionists] *there are discontinuities among [all] species.*” Mark Y. Stoeckle and David S. Thaler, “Why Should Mitochondria Define Species?,” *Human Evolution*, Vol. 33, pp. 1–30, 2018.
- ◆ Using different words, the authors state that “*Species will reproduce after their kind.*”—a phrase repeated eleven times in *Genesis*.
- b. *And let us dispose of a common misconception. The complete transmutation of even one animal species into a different species has never been directly observed either in the laboratory or in the field.*” Dean H. Kenyon (Professor of Biology, San Francisco State University), affidavit presented to the U.S. Supreme Court, No. 85–1513, *Brief of Appellants*, prepared under the direction of William J. Guste Jr., Attorney General of the State of Louisiana, October 1985, p. A-16. Kenyon has repudiated his earlier book advocating evolution.
- ◆ “*Thus so far as concerns the major groups of animals, the creationists seem to have the better of the argument. There is not the slightest evidence that any one of the major groups arose from any other. Each is a special animal complex related, more or less closely, to all the rest, and appearing, therefore, as a special and distinct creation.*” Austin H. Clark, “Animal Evolution,” *Quarterly Review of Biology*, Vol. 3, December 1928, p. 539.
- ◆ “*When we descend to details, we cannot prove that a single species has changed; nor can we prove that the supposed changes are beneficial, which is the groundwork of the theory [of evolution].*” Charles Darwin, *The Life and Letters of Charles Darwin*, Vol. 1, p. 210.
- ◆ “*The fact that all the individual species must be stationed at the extreme periphery of such logic [evolutionary] trees merely emphasized the fact that the order of nature betrays no hint of natural evolutionary sequential arrangements, revealing species to be related as sisters or cousins but never as ancestors and descendants as is required by evolution.*” [emphasis in original] Denton, p. 132.
- c. “*... no human has ever seen a new species form in nature.*” Steven M. Stanley, *The New Evolutionary Timetable* (New York: Basic Books, Inc., 1981), p. 73.

11. Altruism

- a. “*... the existence of altruism between different species—which is not uncommon—remains an obstinate enigma.*” Taylor, p. 225.
- ◆ Some inherited behavior is harmful to the animal but beneficial to unrelated species. For example, dolphins sometimes protect humans from deadly sharks. Many animals (goats, lambs, rabbits, horses, frogs, toads) scream when a predator discovers them. This increases their exposure but warns other species.
- b. From an evolutionist’s point of view, a very costly form of altruism occurs when an animal forgoes reproduction while caring for another individual’s young. This occurs in some human societies where a man has multiple wives who share in raising the children of one wife. More well-known examples include celibate individuals (such as nuns and many missionaries) who devote themselves to helping others. Such traits should never have evolved, or if they accidentally arose, they should quickly die out.

Adoption is another example.

From a Darwinian standpoint, going childless by choice is hard enough to explain, but adoption, as the arch-Darwinist Richard Dawkins notes, is a double whammy. Not only do you reduce, or at least fail to increase, your own reproductive success, but you improve someone else’s. Since the birth parent is your rival in the great genetic steeplechase, a gene that encourages adoption should be knocked out of the running in fairly short order. Cleo Sullivan, “The Adoption Paradox,” *Discover*, January 2001, p. 80.

Adoption is known even among mice, rats, skunks, llamas, deer, caribou, kangaroos, wallabies, seals, sea lions, dogs, pigs, goats, sheep, bears, and many primates. Altruism is also shown by some people who have pets—a form of adoption—especially individuals who have pets instead of having children.

- ◆ Humans, vertebrates, and invertebrates frequently help raise unrelated young of others.

... it is not clear that the degree of relatedness is consistently higher in cooperative breeders than in other species that live in stable groups but do not breed cooperatively. In many societies of vertebrates as well as invertebrates, differences in contributions to rearing young do not appear to vary with the relatedness of helpers, and several studies of cooperative birds and mammals have shown that helpers can be unrelated

to the young they are raising and that the unrelated helpers invest as heavily as close relatives. Tim Clutton-Brock, "Breeding Together: Kin Selection and Mutualism in Cooperative Vertebrates," *Science*, Vol. 296, 5 April 2002, p. 69.

Six different studies were cited in support of the conclusions above.

- c. *"Ultimately, moral guidelines determine an essential part of economic life. How could such forms of social behavior evolve? This is a central question for Darwinian theory. The prevalence of altruistic acts—providing benefits to a recipient at a cost to the donor—can seem hard to reconcile with the idea of the selfish gene, the notion that evolution at its base acts solely to promote genes that are most adept at engineering their own proliferation. Benefits and costs are measured in terms of the ultimate biological currency—reproductive success. Genes that reduce this success are unlikely to spread in a population."* Karl Sigmund et al., "The Economics of Fair Play," *Scientific American*, Vol. 286, January 2002, p. 87.
- d. Some evolutionists propose the following explanation for this long-standing and widely recognized problem for evolution: *"Altruistic behavior may prevent the altruistic individual from passing on his or her genes, but it benefits the individual's clan that carries a few of those genes."* This hypothesis has five problems—several are fatal.
 - ❖ Observations do not support it. [See Clutton-Brock, pp. 69–72.]
 - ❖ *"... altruistic behavior toward relatives may at some later time lead to increased competition between relatives, reducing or even completely removing the net selective advantage of altruism."* Stuart A. West et al., "Cooperation and Competition between Relatives," *Science*, Vol. 296, 5 April 2002, p. 73.
 - ❖ If individual X's altruistic trait was inherited, that trait should be carried recessively in only half the individual's brothers and sisters, one-eighth of the first cousins, etc. The key question then is: Does this "fractional altruism" benefit these relatives enough that they sire enough children with the altruistic trait? On average, one or more in the next generation must have the trait, and no generation can ever lose the trait. Otherwise, the trait will become extinct.
 - ❖ From an evolutionist's perspective, all altruistic traits originated as a mutation. The brothers, sisters, or cousins of the first person to have the mutation would not have the trait. Even if many relatives benefited from the altruism, the trait would not survive the first generation.
 - ❖ The hypothesis fails to explain altruism between different species. Without discussing examples that require a knowledge of the life patterns of such species, consider the simple example above of humans who forgo having children in order to care for animals.
 - ◆ Edward O. Wilson, an early proponent of this evolutionary explanation for altruism, now recognizes its failings.

I found myself moving away from the position I'd taken 30 years ago, which has become the standard theory. What I've done is to say that maybe collateral kin selection is not so important. These ants and termites in the early stages of evolution—they can't recognize kin like that. There's very little evidence that they're determining who's a brother, a sister, a cousin, and so on. They are not acting to favor collateral kin. Edward O. Wilson, "The Discover Interview," *Discover*, June 2006, p. 61.

- ◆ *"... in a pair of studies researchers show that chimpanzees will give up a treat to help out an unrelated chimp, and that chimps in the wild choose to go out on risky patrols to protect others, even when they aren't their own kin."* "Chimps Show Signs of Altruism," *Science*, Vol. 356, 23 June 2017, p. 1215.

12. Extraterrestrial Life?

- a. The widely publicized claims, made by NASA in 1996, to have found fossilized life in a meteorite from Mars are now largely dismissed. [See Richard A. Kerr, "Requiem for Life on Mars? Support for Microbes Fades," *Science*, Vol. 282, 20 November 1998, pp. 1398–1400.]

13. Language

- a. *Because we have language, we have modern technology, culture, art and scientific inquiry. We have the ability to ask questions such as, Why is language unique to humans? Cristine Kenneally, "What Makes Language Distinctly Human?"* *Scientific American*, Vol. 319, September 2018, p. 56.

The article goes on to explain that the question, "How did languages evolve?" has been banned in many societies and academic circles since the 1870s, because it could not be answered, and presumably was an embarrassment to evolutionists.

- b. G. F. Marcus et al., "Rule Learning by Seven-Month-Old Infants," *Science*, Vol. 283, 1 January 1999, pp. 77–80.
- c. Arthur Custance, *Genesis and Early Man* (Grand Rapids: Zondervan Publishing House, 1975), pp. 250–271.
- ◆ *"Nobody knows how [language] began. There doesn't seem to be anything like syntax in non-human animals and it is hard to imagine evolutionary forerunners of it."* Richard Dawkins, *Unweaving the Rainbow* (Boston: Houghton Mifflin Co., 1998), p. 294.
- d. *"Projects devoted to teaching chimpanzees and gorillas to use language have shown that these apes can learn vocabularies of visual symbols. There is no evidence, however, that apes can combine such symbols in order to create new meanings. The function of the symbols of an ape's vocabulary appears to be not so much to identify things or to convey information as it is to satisfy a demand that it use that symbol in order to obtain some reward."* H. S. Terrace et al., "Can an Ape Create a Sentence?" *Science*, Vol. 206, 23 November 1979, p. 900.
- ◆ *"... human language appears to be a unique phenomenon, without significant analogue in the animal world."* Noam

- Chomsky, *Language and Mind* (Chicago: Harcourt, Brace & World, Inc., 1968), p. 59.
- e. “No languageless community has ever been found.” Jean Aitchison, *The Atlas of Languages* (New York: Facts on File, Inc., 1996), p. 10.
- ◆ “There is no reason to suppose that the ‘gaps’ [in language development between apes and man] are bridgeable.” Chomsky, p. 60.
- f. “... [concerning imitation, not language] only humans can lose one modality (e.g., hearing) and make up for this deficit by communicating with complete competence in a different modality (i.e., signing).” Marc D. Hauser et al., “The Faculty of Language: What Is It, Who Has It, and How Did It Evolve?” *Science*, Vol. 298, 22 November 2002, p. 1575.
- g. David C. C. Watson, *The Great Brain Robbery* (Chicago: Moody Press, 1976), pp. 83–89.
- ◆ George Gaylord Simpson acknowledged the vast gulf that separates animal communication and human languages. Although he recognized the apparent pattern of language development from complex to simple, he could not digest it. He simply wrote, “Yet it is incredible that the first language could have been the most complex.” He then shifted to a new subject. George Gaylord Simpson, *Biology and Man* (New York: Harcourt, Brace & World, Inc., 1969), p. 116.
- ◆ “Many other attempts have been made to determine the evolutionary origin of language, and all have failed. ... Even the peoples with least complex cultures have highly sophisticated languages, with complex grammar and large vocabularies, capable of naming and discussing anything that occurs in the sphere occupied by their speakers. ... The oldest language that can reasonably be reconstructed is already modern, sophisticated, complete from an evolutionary point of view.” George Gaylord Simpson, “The Biological Nature of Man,” *Science*, Vol. 152, 22 April 1966, p. 477.
- ◆ “The evolution of language, at least within the historical period, is a story of progressive simplification.” Albert C. Baugh, *A History of the English Language*, 2nd edition (New York: Appleton-Century-Crofts, Inc., 1957), p. 10.
- ◆ “The so-called primitive languages can throw no light on language origins, since most of them are actually more complicated in grammar than the tongues spoken by civilized peoples.” Ralph Linton, *The Tree of Culture* (New York: Alfred A. Knopf, 1957), p. 9.
- h. “It was Charles Darwin who first linked the evolution of languages to biology. In *The Descent of Man* (1871), he wrote, ‘the formation of different languages and of distinct species, and the proofs that both have been developed through a gradual process, are curiously parallel.’ But linguists cringe at the idea that evolution might transform simple languages into complex ones. Today it is believed that no language is, in any basic way, ‘prior’ to any other, living or dead. Language alters even as we speak it, but it neither improves nor degenerates.” Philip E. Ross, “Hard Words,” *Scientific American*, Vol. 264, April 1991, p. 144.
- ◆ “Noam Chomsky ... has firmly established his point that grammar, and in particular syntax, is innate. Interested linguistics people ... are busily speculating on how the language function could have evolved ... Derek Bickerton (Univ. Hawaii) insists that this faculty must have come into being all at once.” John Maddox, “The Price of Language?” *Nature*, Vol. 388, 31 July 1997, p. 424.

14. Speech

- a. Mark P. Cosgrove, *The Amazing Body Human* (Grand Rapids: Baker Book House, 1987), pp. 106–109.
- “If we are honest, we will face the facts and admit that we can find no evolutionary development to explain our unique speech center [in the human brain].” *Ibid.*, p. 164.
- b. Jeffrey T. Laitman, “The Anatomy of Human Speech,” *Natural History*, Vol. 93, August 1984, pp. 20–26.
- ◆ “Chimpanzees communicate with each other by making vocal sounds just as most mammals do, but they don’t have the capacity for true language, either verbally or by using signs and symbols. ... Therefore, the speech sound production ability of a chimpanzee vocal tract is extremely limited, because it lacks the ability to produce the segmental contrast of consonants and vowels in a series. ... I conclude that all of the foregoing basic structural and functional deficiencies of the chimpanzee vocal tract, which interfere or limit the production of speech sounds, also pertain to all of the other nonhuman primates.” Edmund S. Crelin, *The Human Vocal Tract* (New York: Vantage Press, 1987), p. 83.

15. Codes, Programs, and Information

- a. In 2010, another level of complexity was discovered in the genetic code. On a strand of DNA, a sequence of three adjacent nucleotides forms a unit in the genetic code called a codon. Prior to 2010, some codons were thought to have the same function as others. That turns out to not be the case.
- ... synonymous codon changes can so profoundly change the role of a protein [that it] adds a new level of complexity to how we interpret the genetic code. Ivana Weygand-Durasevic and Michael Ibba, “New Roles for Codon Usage,” *Science*, Vol. 329, 17 September 2010, p. 1474. Also see Fangliang Zhang et al., “Differential Arginylation of Actin Isoforms Is Regulated by Coding Sequence-Dependent Degradation,” *Science*, Vol. 329, 17 September 2010, pp. 1534–1537.
- b. “Genomes [all the DNA of a species] are remarkable in that they encode most of the functions necessary for their interpretation and propagation.” Anne-Claude Gavin et al., “Proteome Survey Reveals Modularity of the Yeast Cell Machinery,” *Nature*, Vol. 440, 30 March 2006, p. 631.
- c. The genetic code is remarkably insensitive to translation errors. If the code were produced by random processes, as evolutionists believe, life would have needed about a million different starts before a code could have been stumbled on that was as resilient as the code used by all

life today. [See Stephen J. Freeland and Laurence D. Hurst, "Evolution Encoded," *Scientific American*, Vol. 290, April 2004, pp. 84–91.]

- ◆ *"This analysis gives us a reason to believe that the A–T and G–C choice forms the best pairs that are the most different from each other, so that their ubiquitous use in living things represents an efficient and successful choice rather than an accident of evolution."* [emphasis added] Larry Liebovitch, as quoted by David Bradley, "The Genome Chose Its Alphabet with Care," *Science*, Vol. 297, 13 September 2002, p. 1790.
- ◆ *"It was already clear that the genetic code is not merely an abstraction, but also the embodiment of life's mechanisms; the consecutive triplets of nucleotides in DNA (called codons) are inherited but they also guide the construction of proteins. So it is disappointing, but not surprising, that the origin of the genetic code is still as obscure as the origin of life itself."* John Maddox, "The Genetic Code by Numbers," *Nature*, Vol. 367, 13 January 1994, p. 111.
- d. *"No matter how many 'bits' of possible combinations it has, there is no reason to call it 'information' if it doesn't at least have the potential of producing something useful. What kind of information produces function? In computer science, we call it a 'program.' Another name for computer software is an 'algorithm.' No man-made program comes close to the technical brilliance of even Mycoplasma genetic algorithms. Mycoplasmas are the simplest known organisms with the smallest known genome, to date. How was its genome and other living organisms' genomes programmed?"* Abel and Trevors, p. 8.
- ◆ *"No known hypothetical mechanism has even been suggested for the generation of nucleic acid algorithms."* Jack T. Trevors and David L. Abel, "Chance and Necessity Do Not Explain the Origin of Life," *Cell Biology International*, Vol. 28, 2004, p. 730.
- e. How can we measure information? A computer file might contain information for printing a story, reproducing a picture at a given resolution, or producing a widget to specified tolerances. Information can usually be compressed to some degree, just as the English language could be compressed by eliminating every "u" that directly follows a "q." If compression could be accomplished to the maximum extent possible (eliminating all redundancies and unnecessary information), the number of bits (0s or 1s) would be a measure of the information needed to produce the story, picture, or widget.

Each living system can be described by its age and the information stored in its DNA. Each basic unit of DNA, called a *nucleotide*, can be one of four types. Therefore, each nucleotide represents two ($\log_2 4 = 2$) bits of information. Conceptual systems, such as ideas, a filing system, or a system for betting on race horses, can be explained in books. Several bits of information can define each symbol or letter in these books. *The number of bits of information, after compression, needed to duplicate and achieve the purpose of a system will be defined as its information content. That number is also a measure of the system's complexity.*

Objects and organisms are not information. Each is a complex combination of matter and energy that the proper equipment—and information—could theoretically produce.

Matter and energy alone cannot produce complex objects, living organisms, or information.

While we may not know the precise amount of information in different organisms, we do know those numbers are enormous and quite different. Simply changing (mutating) a few bits to begin the gigantic leap toward evolving a new organ or organism would likely kill the host.

- ◆ *"Information is information, not matter or energy. No materialism which does not admit this can survive at the present day."* Norbert Wiener, *Cybernetics; or, Control and Communication in the Animal and the Machine*, 2nd edition (Cambridge, Massachusetts: MIT Press, 1948), p. 132.
- ◆ Werner Gitt (Professor of Information Systems) describes man as the most complex information processing system on earth. Gitt estimated that about 3×10^{24} bits of information are processed daily in an average human body. That is thousands of times more than all the information in all the world's libraries. [See Werner Gitt, *In the Beginning Was Information*, 2nd edition (Bielefeld, Germany: CLV, 2000), p. 88.]
- f. *"There is no known law of nature, no known process and no known sequence of events which can cause information to originate by itself in matter."* Ibid., p. 107.
- ◆ *"If there are more than several dozen nucleotides in a functional sequence, we know that realistically they will never just 'fall into place.' This has been mathematically demonstrated repeatedly. But as we will soon see, neither can such a sequence arise randomly one nucleotide at a time. A pre-existing 'concept' is required as a framework upon which a sentence or a functional sequence must be built. Such a concept can only pre-exist within the mind of the author."* Sanford, pp. 124–125.
- g. Because macroevolution requires increasing complexity through natural processes, the organism's information content must spontaneously increase many times. However, natural processes cannot significantly increase the information content of an isolated system, such as a reproductive cell. Therefore, macroevolution cannot occur.
- ◆ *"The basic flaw of all evolutionary views is the origin of the information in living beings. It has never been shown that a coding system and semantic information could originate by itself in a material medium, and the information theorems predict that this will never be possible. A purely material origin of life is thus precluded."* Gitt, p. 124.
- h. Information theory tells us that the only known way to decrease the entropy of an isolated system is by having intelligence *in* that system. [See, for example, Charles H. Bennett, "Demons, Engines and the Second Law," *Scientific American*, Vol. 257, November 1987, pp. 108–116.] Because the universe is far from its maximum entropy level, a vast intelligence is the only known means by which the universe could have been brought into being. [See also "[Second Law of Thermodynamics](#)" on page 32.]
- i. If the "big bang" occurred, all the matter in the universe was once a hot gas. A gas is one of the most random systems known to science. Random, chaotic movements of gas molecules contain no useful information. Because an

isolated system, such as the universe, cannot generate non-trivial information, the “big bang” could not produce the complex, living universe we have today, which contains astronomical amounts of useful information.

17. Convergent Evolution or Intelligent Design?

- a. “... the definitive mammalian middle ear evolved independently in living monotremes and therians (marsupials and placentals).” Thomas H. Rich et al., “Independent Origins of Middle Ear Bones in Monotremes and Therians,” *Science*, Vol. 307, 11 February 2005, p. 910.
 - ◆ “Because of the complexity of the bone arrangement, some scientists have argued that the innovation arose just once—in a common ancestor of the three mammalian groups. Now, analyses of a jawbone from a specimen of *Teinolophos trusleri*, a shrew-size creature that lived in Australia about 115 million years ago, have dealt a blow to that notion.” Sid Perkins, “Groovy Bones,” *Science News*, Vol. 167, 12 February 2005, p. 100.
- b. Also, for mammals to hear requires the organ of Corti and complex “wiring” in the brain. No known reptile (the supposed ancestor of mammals), living or fossil, has anything resembling this amazing organ.
- c. “By this we have also proved that a morphological similarity between organisms cannot be used as proof of a phylogenetic [evolutionary] relationship ... it is unscientific to maintain that the morphology may be used to prove relationships and evolution of the higher categories of units, ...” Nilsson, p. 1143.
 - ◆ “But biologists have known for a hundred years that homologous [similar] structures are often not produced by similar developmental pathways. And they have known for thirty years that they are often not produced by similar genes, either. So there is no empirically demonstrated mechanism to establish that homologies are due to common ancestry rather than common design.” Jonathan Wells, “Survival of the Fakest,” *The American Spectator*, December 2000/January 2001, p. 22.
- d. Fix, pp. 189–191.
 - ◆ Denton, pp. 142–155.
 - ◆ “Therefore, **homologous structures need not be controlled by identical genes, and homology of phenotypes does not imply similarity of genotypes.** [emphasis in original] It is now clear that the pride with which it was assumed that the inheritance of homologous structures from a common ancestor explained homology was misplaced; for such inheritance cannot be ascribed to identity of genes. ... But if it is true that through the genetic code, genes code for enzymes that synthesize proteins which are responsible (in a manner still unknown in embryology) for the differentiation of the various parts in their normal manner, what mechanism can it be that results in the production of homologous organs, the same ‘patterns’, in spite of their not being controlled by the same genes? I asked this question in 1938, and it has not been answered.” [Nor has it been answered today.] Gavin R. deBeer, formerly Professor of Embryology at the University of London and Director of the

British Museum (Natural History), *Homology, An Unsolved Problem* (London: Oxford University Press, 1971), p. 16.

- e. “Structures as obviously homologous as the alimentary canal in all vertebrates can be formed from the roof of the embryonic gut cavity (sharks), floor (lampreys, newts), roof and floor (frogs), or from the lower layer of the embryonic disc, the blastoderm, that floats on the top of heavily yolked eggs (reptiles, birds). It does not seem to matter where in the egg or the embryo the living substance out of which homologous organs are formed comes from. Therefore, **correspondence between homologous structures cannot be pressed back to similarity of position of the cells of the embryo or the parts of the egg out of which these structures are ultimately differentiated.**” [emphasis in original] *Ibid.*, p. 13.

18. Vestigial Organs

- a. “The existence of functionless ‘vestigial organs’ was presented by Darwin, and is often cited by current biology textbooks, as part of the evidence for evolution. ... An analysis of the difficulties in unambiguously identifying functionless structures and an analysis of the nature of the argument, leads to the conclusion that ‘vestigial organs’ provide no evidence for evolutionary theory.” S. R. Scadding, “Do ‘Vestigial Organs’ Provide Evidence for Evolution?” *Evolutionary Theory*, Vol. 5, May 1981, p. 173.
- b. Jerry Bergman and George Howe, “Vestigial Organs” Are Fully Functional (Terre Haute, Indiana: Creation Research Society Books, 1990).
- c. “The appendix is not generally credited with substantial function. However, current evidence tends to involve it in the immunologic mechanism.” Gordon McHardy, “The Appendix,” *Gastroenterology*, Vol. 4, editor J. Edward Berk (Philadelphia: W. B. Saunders Co., 1985), p. 2609.
 - ◆ “Thus, although scientists have long discounted the human appendix as a vestigial organ, a growing quantity of evidence indicates that the appendix does in fact have a significant function as a part of the body’s immune system.” N. Roberts, “Does the Appendix Serve a Purpose in Any Animal?” *Scientific American*, Vol. 285, November 2001, p. 96.
- d. “... the human appendix is well suited as a ‘safe house’ for commensal bacteria, providing support for bacterial growth and potentially facilitating re-inoculation of the colon in the event that the contents of the intestinal tract are purged following exposure to a pathogen. ... the appendix ... is not a vestige.” R. Randal Bollinger et al., “Biofilms in the Large Bowel Suggest an Apparent Function of the Human Vermiform Appendix,” *Journal of Theoretical Biology*, Vol. 249, 2007, p. 826.

19. Two-Celled Life?

- a. E. Lendell Cockrum and William J. McCauley, *Zoology* (Philadelphia: W. B. Saunders Co., 1965), p. 163.
 - ◆ Lynn Margulis and Karlene V. Schwartz, *Five Kingdoms: An Illustrated Guide to the Phyla of Life on Earth* (San Francisco: W. H. Freeman and Co., 1982), pp. 178–179.

- ◆ Perhaps the simplest forms of multicellular life are the Myxozoans, which have 6–12 cells. While they are quite distinct from other multicellular life, they are even more distinct from single-celled life (kingdom Protista). [See James F. Smothers et al., “Molecular Evidence That the Myxozoan Protists are Metazoans,” *Science*, Vol. 265, 16 September 1994, pp. 1719–1721.] So, if they had evolved from anywhere, it would most likely have been from higher, not lower, forms of life. Such a feat should be called *devolution*, not evolution.

Colonial forms of life are an unlikely bridge between single-celled life and multicelled life. The degree of cellular differentiation between colonial forms of life and the simplest multicellular forms of life is vast. For a further discussion, see Libbie Henrietta Hyman, *The Invertebrates: Protozoa through Ctenophora*, Vol. 1 (New York: McGraw-Hill, 1940), pp. 248–255.

- ◆ Nor do Diplomonads (which have two nuclei and four flagella) bridge the gap. Diplomonads are usually parasites.

20. Embryology

- ◆ “*This generalization was originally called the biogenetic law by Haeckel and is often stated as ‘ontogeny [the development of an embryo] recapitulates [repeats] phylogeny [evolution].’ This crude interpretation of embryological sequences will not stand close examination, however. Its shortcomings have been almost universally pointed out by modern authors, but the idea still has a prominent place in biological mythology.*” Paul R. Ehrlich and Richard W. Holm, *The Process of Evolution* (New York: McGraw-Hill, 1963), p. 66.
 - ◆ “*It is now firmly established that ontogeny does **not** repeat phylogeny.*” [emphasis in original] George Gaylord Simpson and William S. Beck, *Life: An Introduction to Biology* (New York: Harcourt, Brace & World, Inc., 1965), p. 241.
 - ◆ Hitching, pp. 202–205.
 - ◆ “*The enthusiasm of the German zoologist, Ernst Haeckel, however, led to an erroneous and unfortunate exaggeration of the information which embryology could provide. This was known as the ‘biogenetic law’ and claimed that embryology was a recapitulation of evolution, or that during its embryonic development an animal recapitulated the evolutionary history of its species.*” Gavin R. deBeer, *An Atlas of Evolution* (New York: Nelson, 1964), p. 38.
 - ◆ “*... the theory of recapitulation has had a great and, while it lasted, regrettable influence on the progress of embryology.*” Gavin R. deBeer, *Embryos and Ancestors*, revised edition (London: Oxford University Press, 1951), p. 10.
 - ◆ “*Moreover, the biogenetic law has become so deeply rooted in biological thought that it cannot be weeded out in spite of its having been demonstrated to be wrong by numerous subsequent scholars.*” Walter J. Bock, “Evolution by Orderly Law,” *Science*, Vol. 164, 9 May 1969, pp. 684–685.
 - ◆ “*... we no longer believe we can simply read in the embryonic development of a species its exact evolutionary history.*”
- ◆ Hubert Frings and Marie Frings, *Concepts of Zoology* (Toronto: Macmillan Publishing Co., 1970), p. 267.
 - ◆ “*The type of analogical thinking which leads to theories that development is based on the recapitulation of ancestral stages or the like no longer seems at all convincing or even interesting to biologists.*” Conrad Hal Waddington, *Principles of Embryology* (London: George Allen and Unwin Ltd., 1956), p. 10.
 - ◆ “*Surely the biogenetic law is as dead as a doornail.*” Keith Stewart Thomson, “Ontogeny and Phylogeny Recapitulated,” *American Scientist*, Vol. 76, May–June 1988, p. 273.
 - ◆ “*The biogenetic law—embryologic recapitulation—I think, was debunked back in the 1920s by embryologists.*” David Raup, as taken from page 16 of an approved and verified transcript of a taped interview conducted by Luther D. Sunderland on 27 July 1979. [See also Luther D. Sunderland, *Darwin’s Enigma* (San Diego: Master Book Publishers, 1984), p. 119.]
 - ◆ “*The theory of recapitulation was destroyed in 1921 by Professor Walter Garstang in a famous paper. Since then no respectable biologist has ever used the theory of recapitulation, because it was utterly unsound, created by a Nazi-like preacher named Haeckel.*” Ashley Montagu, as quoted by Sunderland, p. 119.
- ◆ In 1868, Haeckel, using distorted data, advanced this “biogenetic law.” It was quickly adopted in textbooks and encyclopedias worldwide. Thompson explains:

A natural law can only be established as an induction from facts. Haeckel was of course unable to do this. What he did was to arrange existing forms of animal life in a series proceeding from the simple to the complex, intercalating [inserting] imaginary entities where discontinuity existed and then giving the embryonic phases names corresponding to the stages in his so-called evolutionary series. Cases in which this parallelism did not exist were dealt with by the simple expedient of saying that the embryological development had been falsified. When the “convergence” of embryos was not entirely satisfactory, Haeckel altered the illustrations of them to fit his theory. The alterations were slight but significant. The “biogenetic law” as a proof of evolution is valueless. W. R. Thompson, p. 12.

 - ◆ “*To support his case he [Haeckel] began to fake evidence. Charged with fraud by five professors and convicted by a university court at Jena, he agreed that a small percentage of his embryonic drawings were forgeries; he was merely filling in and reconstructing the missing links when the evidence was thin, and he claimed unblushingly that ‘hundreds of the best observers and biologists lie under the same charge.’*” Pitman, p. 120.
 - ◆ “*A Professor Arnold Bass charged that Haeckel had made changes in pictures of embryos which he [Bass] had drawn. Haeckel’s reply to these charges was that if he is to be accused of falsifying drawings, many other prominent scientists should also be accused of the same thing ...*” Bolton Davidheiser, *Evolution and Christian Faith* (Phillipsburg, New Jersey: The Presbyterian and Reformed Publishing Co., 1969), pp. 76–77.
 - ◆ M. Bowden, *Ape-Men: Fact or Fallacy?* 2nd edition (Bromley, England: Sovereign Publications, 1981), pp. 142–143.

- ◆ Wilbert H. Rusch, Sr., “Ontogeny Recapitulates Phylogeny,” *Creation Research Society Quarterly*, Vol. 6, June 1969, pp. 27–34.
- ◆ “... *ontogeny recapitulates phylogeny, meaning that in the course of its development [ontogeny] an embryo recapitulates [repeats] the evolutionary history of its species [phylogeny]. This idea was fathered by Ernst Haeckel, a German biologist who was so convinced that he had solved the riddle of life’s unfolding that he doctored and faked his drawings of embryonic stages to prove his point.*” Fix, p. 285.
- ◆ “[The German scientist Wilhelm His] *accused Haeckel of shocking dishonesty in repeating the same picture several times to show the similarity among vertebrates at early embryonic stages in several plates of [Haeckel’s book].*” Stephen Jay Gould, *Ontogeny and Phylogeny* (Cambridge, Massachusetts: The Belknap Press of Harvard University Press, 1977), p. 430.
- ◆ “*It looks like it’s turning out to be one of the most famous fakes in biology.*” Michael K. Richardson, as quoted by Elizabeth Pennisi, “Haeckel’s Embryos: Fraud Rediscovered,” *Science*, Vol. 277, 5 September 1997, p. 1435.
- ◆ “*When we compare his [Haeckel’s] drawings of a young echidna embryo with the original, we find that he removed the limbs (see Fig. 1). This cut was selective, applying only to the young stage. It was also systematic because he did it to other species in the picture. Its intent is to make the young embryos look more alike than they do in real life.*” Michael K. Richardson and Gerhard Keuck, “A Question of Intent: When Is a ‘Schematic’ Illustration a Fraud?” *Nature*, Vol. 410, 8 March 2001, p. 144.
- c. “*Another point to emerge from this study is the considerable inaccuracy of Haeckel’s famous figures. These drawings are still widely reproduced in textbooks and review articles, and continue to exert a significant influence on the development of ideas in this field.*” Michael K. Richardson et al., “There Is No Highly Conserved Embryonic Stage in the Vertebrates,” *Anatomy and Embryology*, Vol. 196, August 1997, p. 104.

21. Rapid Burial

- a. Thousands of jellyfish, many bigger than a dinner plate, are found in at least seven different horizons of *coarse-grained, abrasive sandstone* in Wisconsin. [See James W. Hagadorn et al., “Stranded on a Late Cambrian Shoreline: Medusae from Central Wisconsin,” *Geology*, Vol. 30, February 2002, pp. 147–150.]

Coarse grains slowly covering a jellyfish would allow atmospheric oxygen to migrate in and produce rapid decay. Burial in clay or mud would better shield an organism from decay. If coarse-grain sand buried these jellyfish in a storm, turbulence and abrasion by the sand grains would tear and destroy the jellyfish. The liquefaction chapter (pages 195–213) explains how thousands of jellyfish were gently collected and preserved in coarse-grained sand.

Charles Darwin recognized the problem of finding fossilized soft-bodied organisms, such as jellyfish. He wrote:

No organism wholly soft can be preserved. Charles Darwin, *The Origin of Species*, p. 330.

Again, a prediction of evolution is seen to be wrong.

- ◆ Preston Cloud and Martin F. Glaessner, “The Ediacarian Period and System: Metazoa Inherit the Earth,” *Science*, Vol. 217, 27 August 1982, pp. 783–792. [See also the cover of that issue.]
- ◆ Martin F. Glaessner, “Pre-Cambrian Animals,” *Scientific American*, Vol. 204, March 1961, pp. 72–78.
- b. Donald G. Mikulic et al., “A Silurian Soft-Bodied Biota,” *Science*, Vol. 228, 10 May 1985, pp. 715–717.
- ◆ “... *preconditions for the preservation of soft-bodied faunas: rapid burial of fossils in undisturbed sediment; deposition in an environment free from the usual agents of immediate destruction—primarily oxygen and other promoters of decay, and the full range of organisms, from bacteria to large scavengers, that quickly reduce most carcasses to oblivion in nearly all earthly environments; and minimal disruption by the later ravages of heat, pressure, fracturing, and erosion. ... But the very conditions that promote preservation also decree that few organisms, if any, make their natural homes in such places.*” Stephen Jay Gould, *Wonderful Life* (New York: W. W. Norton & Co., 1989), pp. 61–62.
- c. Presse Grayloise, “Very Like a Whale,” *The Illustrated London News*, 1856, p. 116.
- ◆ Sunderland, pp. 111–114.
- ◆ David Starr Jordan, “A Miocene Catastrophe,” *Natural History*, Vol. 20, January–February 1920, pp. 18–22.
- ◆ Hugh Miller, *The Old Red Sandstone, or New Walks in an Old Field* (Boston: Gould and Lincoln, 1858), pp. 221–225.
- d. Harold G. Coffin, *Origin By Design* (Washington, D.C.: Review and Herald Publishing Assn., 1983), pp. 30–40.

23. Fossil Gaps

- a. “*But, as by this theory innumerable transitional forms must have existed, why do we not find them imbedded in countless numbers in the crust of the earth?*” Darwin, *The Origin of Species*, p. 163.

“... the number of intermediate varieties, which have formerly existed [must] truly be enormous. Why then is not every geological formation and every stratum full of such intermediate links? Geology assuredly does not reveal any such finely-graduated organic chain; and this, perhaps, is the most obvious and serious objection which can be urged against the theory [of evolution].” Ibid., p. 323.

Darwin then explained that he thought that these gaps existed because of the “imperfection of the geologic record.” Early Darwinians expected the gaps would be filled as fossil exploration continued. Most paleontologists now agree that this expectation has not been fulfilled.

- ◆ The Field Museum of Natural History in Chicago has one of the largest collections of fossils in the world. Consequently, its former dean, Dr. David Raup, was highly qualified to discuss the absence of transitions in the fossil record.

Well, we are now about 120 years after Darwin and the knowledge of the fossil record has been greatly expanded. We now have a quarter of a million fossil species but the situation hasn't changed much. The record of evolution is still surprisingly jerky and, ironically, we have even fewer examples of evolutionary transition than we had in Darwin's time. By this I mean that some of the classic cases of darwinian change in the fossil record, such as the evolution of the horse in North America, have had to be discarded or modified as a result of more detailed information—what appeared to be a nice simple progression when relatively few data were available now appears to be much more complex and much less gradualistic. So Darwin's problem has not been alleviated in the last 120 years and we still have a record which does show change but one that can hardly be looked upon as the most reasonable consequence of natural selection. David M. Raup, "Conflicts Between Darwin and Paleontology," *Field Museum of Natural History Bulletin*, Vol. 50, January 1979, p. 25.

- ◆ "Surely the lack of gradualism—the lack of intermediates—is a major problem." Dr. David Raup, as taken from page 16 of an approved and verified transcript of a taped interview conducted by Luther D. Sunderland on 27 July 1979.
- ◆ "In fact, the fossil record does not convincingly document a single transition from one species to another." Stanley, p. 95.
- ◆ "But fossil species remain unchanged throughout most of their history and the record fails to contain a single example of a significant transition." David S. Woodruff, "Evolution: The Paleobiological View," *Science*, Vol. 208, 16 May 1980, p. 716.
- ◆ Dr. Colin Patterson, a senior paleontologist at the British Museum (Natural History), was asked by Luther D. Sunderland why no evolutionary transitions were shown in Dr. Patterson's recent book, *Evolution*. In a personal letter, Patterson said:

I fully agree with your comments on the lack of direct illustration of evolutionary transitions in my book. If I knew of any, fossil or living, I would certainly have included them. You suggest that an artist should be asked to visualise such transformations, but where would he get the information from? I could not, honestly, provide it, and if I were to leave it to artistic licence, would that not mislead the reader? ... Yet Gould and the American Museum people are hard to contradict when they say that there are no transitional fossils. As a palaeontologist myself, I am much occupied with the philosophical problems of identifying ancestral forms in the fossil record. You say that I should at least "show a photo of the fossil from which each type organism was derived." I will lay it on the line—there is not one such fossil for which one could make a watertight argument. Copy of letter, dated 10 April 1979, from Patterson to Sunderland.
- ◆ "But the curious thing is that there is a consistency about the fossil gaps: **the fossils go missing in all the important places.** When you look for links between major groups of animals, they simply aren't there; at least, not in enough numbers to put their status beyond doubt. Either they don't exist at all, or they are so rare that endless argument goes on about whether a particular fossil is, or isn't, or might be, transitional between this group or that." [emphasis in original] Hitching, p. 19.
- ◆ "There is no more conclusive refutation of Darwinism than that furnished by palaeontology. Simple probability indicates that fossil hoards can only be test samples. Each sample, then, should represent a different stage of evolution, and there ought to be merely 'transitional' types, no definition and no species. Instead of this we find perfectly stable and unaltered forms persevering through long ages, forms that have not developed themselves on the fitness principle, but **appear suddenly and at once in their definitive shape**; that do not thereafter evolve towards better adaptation, but become rarer and finally disappear, while quite different forms crop up again. What unfolds itself, in ever-increasing richness of form, is the great classes and kinds of living beings which **exist aboriginally and exist still, without transition types**, in the grouping of today." [emphasis in original] Oswald Spengler, *The Decline of the West*, Vol. 2 (New York: Alfred A. Knopf, 1966), p. 32.
- ◆ "This regular absence of transitional forms is not confined to mammals, but is an almost universal phenomenon, as has long been noted by paleontologists. It is true of almost all orders of all classes of animals, both vertebrate and invertebrate. A fortiori, it is also true of the classes, themselves, and of the major animal phyla, and it is apparently also true of analogous categories of plants." George Gaylord Simpson, *Tempo and Mode in Evolution* (New York: Columbia University Press, 1944), p. 107.

"... the geologic record did not then and still does not yield a finely graduated chain of slow and progressive evolution. In other words, there are not enough intermediates. There are very few cases where one can find a gradual transition from one species to another and very few cases where one can look at a part of the fossil record and actually see that organisms were improving in the sense of becoming better adapted." Ibid., p. 23.
- ◆ "... there are about 25 major living subdivisions (phyla) of the animal kingdom alone, all with gaps between them that are not bridged by known intermediates." Francisco J. Ayala and James W. Valentine, *Evolving, The Theory and Processes of Organic Evolution* (Menlo Park, California: The Benjamin Cummings Publishing Co., 1979), p. 258.

"Most orders, classes, and phyla appear abruptly, and commonly have already acquired all the characters that distinguish them." Ibid., p. 266.
- ◆ "All paleontologists know that the fossil record contains precious little in the way of intermediate forms; transitions between major groups are characteristically abrupt." Gould, "The Return of Hopeful Monsters," p. 23.
- ◆ "The extreme rarity of transitional forms in the fossil record persists as the trade secret of paleontology. The evolutionary trees that adorn our textbooks have data only at the tips and nodes of their branches; the rest is inference, however reasonable, not the evidence of fossils. ... We fancy ourselves as the only true students of life's history, yet to preserve our favored account of evolution by natural selection we view our data as

so bad that we never see the very process we profess to study." Stephen Jay Gould, "Evolution's Erratic Pace," *Natural History*, Vol. 86, May 1977, p. 14.

"New species almost always appeared suddenly in the fossil record with no intermediate links to ancestors in older rocks of the same region." *Ibid.*, p. 12.

- ◆ "The absence of fossil evidence for intermediary stages between major transitions in organic design, indeed our inability, even in our imagination, to construct functional intermediates in many cases, has been a persistent and nagging problem for gradualistic accounts of evolution." Stephen Jay Gould, "Is a New and General Theory of Evolution Emerging?" *Paleobiology*, Vol. 6, No. 1, 1980, p. 127.

- ◆ In a published interview, Dr. Niles Eldredge, an invertebrate paleontologist at the American Museum of Natural History, stated:

But the smooth transition from one form of life to another which is implied in the theory is ... not borne out by the facts. The search for "missing links" between various living creatures, like humans and apes, is probably fruitless ... because they probably never existed as distinct transitional types ... But no one has yet found any evidence of such transitional creatures. This oddity has been attributed to gaps in the fossil record which gradualists expected to fill when rock strata of the proper age had been found. In the last decade, however, geologists have found rock layers of all divisions of the last 500 million years and no transitional forms were contained in them. If it is not the fossil record which is incomplete then it must be the theory. "Missing, Believed Nonexistent," *Manchester Guardian* (The Washington Post Weekly), Vol. 119, 26 November 1978, p. 1.

Gould and Eldredge claimed transitional fossils are missing because rapid evolutionary jumps (which they called *punctuated equilibria*) occurred over these gaps. They did not explain how this could happen.

Many geneticists are shocked by the proposal of Gould and Eldredge. Why would they propose something so contradictory to genetics? Gould and Eldredge were forced to say that evolution must proceed in jumps. Never explained, in genetic and mathematical terms, is how such large jumps could occur. To some, this desperation is justified.

- ◆ "... the gradual morphological transitions between presumed ancestors and descendants, anticipated by most biologists, are missing." David E. Schindel (Curator of Invertebrate Fossils, Peabody Museum of Natural History), "The Gaps in the Fossil Record," *Nature*, Vol. 297, 27 May 1982, p. 282.
- ◆ "Despite the bright promise that paleontology provides a means of 'seeing' evolution, it has presented some nasty difficulties for evolutionists the most notorious of which is the presence of 'gaps' in the fossil record. Evolution requires intermediate forms between species and paleontology does not provide them." David B. Kitts (School of Geology and Geophysics,

University of Oklahoma), "Paleontology and Evolutionary Theory," *Evolution*, Vol. 28, September 1974, p. 467.

- ◆ "In spite of the immense amount of the paleontological material and the existence of long series of intact stratigraphic sequences with perfect records for the lower categories, transitions between the higher categories are missing." Goldschmidt, p. 98.

"When a new phylum, class, or order appears, there follows a quick, explosive (in terms of geological time) diversification so that practically all orders or families known appear suddenly and without any apparent transitions." *Ibid.*, p. 97.

- ◆ "There is no fossil record establishing historical continuity of structure for most characters that might be used to assess relationships among phyla." Katherine G. Field et al., "Molecular Phylogeny of the Animal Kingdom," *Science*, Vol. 239, 12 February 1988, p. 748.

- b. "The prokaryotes came first; eukaryotes (all plants, animals, fungi and protists) evolved from them, and to this day biologists hotly debate how this transition took place, with about 20 different theories on the go. ... [What was thought to be an intermediate between prokaryotes and eukaryotes] is no longer tenable." Katrin Henze and William Martin, "Essence of Mitochondria," *Nature*, Vol. 426, 13 November 2003, p. 127.

- c. If evolution happened, nonvascular plants should have preceded vascular plants. However, fossils of nonvascular plants are not found in strata evolutionists believe were deposited before the earliest vascular plants appeared.

The bryophytes [nonvascular plants] are presumed to have evolved before the appearance and stabilization of vascular tissue—that is, before the appearance of these tracheophytes [vascular plants]—although there is no early bryophyte [nonvascular plant] fossil record.

Lynn Margulis and Karlene V. Schwartz, p. 250.

"The actual steps that led to the origin of seeds and fruits are not known ..." *Ibid.*

- ◆ "It has long been hoped that extinct plants will ultimately reveal some of the stages through which existing groups have passed during the course of their development, but it must be freely admitted that this aspiration has been fulfilled to a very slight extent, even though paleobotanical research has been in progress for more than one hundred years. As yet we have not been able to trace the phylogenetic history of a single group of modern plants from its beginning to the present." Chester A. Arnold, *An Introduction to Paleobotany* (New York: McGraw-Hill, 1947), p. 7.

- ◆ "... to the unprejudiced, the fossil record of plants is in favour of special creation. If, however, another explanation could be found for this hierarchy of classification, it would be the knell [the death signal] of the theory of evolution. Can you imagine how an orchid, a duckweed, and a palm have come from the same ancestry, and have we any evidence for this assumption? The evolutionist must be prepared with an answer, but I think that most would break down before an inquisition. Textbooks hoodwink." E. J. H. Corner, "Evolution," *Contemporary*

Botanical Thought, editors Anna M. MacLeod and L. S. Cogley (Chicago: Quadrangle Books, 1961), p. 97.

- ◆ “*The absence of any known series of such intermediates imposes severe restrictions on morphologists interested in the ancestral source of angiosperms [flowering plants] and leads to speculation and interpretation of homologies and relationships on the basis of the most meager circumstantial evidence.*” Charles B. Beck, *Origin and Early Evolution of Angiosperms* (New York: Columbia University Press, 1976), p. 5.
- ◆ “*The origin of angiosperms, an ‘abominable mystery’ to Charles Darwin, remained so 100 years later and is little better today.*” Colin Patterson et al., “Congruence between Molecular and Morphological Phylogenies,” *Annual Review of Ecology and Systematics*, Vol. 24, 1993, p. 170.
- d. “*The insect fossil record has many gaps.*” “*Insects: Insect Fossil Record,*” *Britannica CD, Version 97* (Chicago: Encyclopaedia Britannica, Inc., 1997).
- e. Speaking of the lack of transitional fossils between the invertebrates and vertebrates, Smith admits:

As our present information stands, however, the gap remains unbridged, and the best place to start the evolution of the vertebrates is in the imagination.

Homer W. Smith, *From Fish to Philosopher* (Boston: Little, Brown, and Co., 1953), p. 26.
- ◆ “*How this earliest chordate stock evolved, what stages of development it went through to eventually give rise to truly fishlike creatures we do not know. Between the Cambrian when it probably originated, and the Ordovician when the first fossils of animals with really fishlike characteristics appeared, there is a gap of perhaps 100 million years which we will probably never be able to fill.*” Francis Downes Ommanney, *The Fishes*, Life Nature Library (New York: Time, Inc., 1963), p. 60.
- ◆ “*Origin of the vertebrates is obscure—there is no fossil record preceding the occurrence of fishes in the late Ordovician time.*” Arthur N. Strahler, *Science and Earth History: The Evolution/Creation Controversy* (Buffalo, New York: Prometheus Books, 1987), p. 316.
- ◆ “*The problem is easily stated—vertebrates have so many special features, from large brains to complex physiologies to unique tissues such as enamel and bone—that their evolution from invertebrates is obscure.*” Henry Gee, “Origin and Evolution of Vertebrates,” *Nature*, Vol. 520, 23 April 2015, p. 449.
- f. “*... there are no intermediate forms between finned and limbed creatures in the fossil collections of the world.*” Taylor, p. 60.
- g. Evolutionists believe that amphibians evolved into reptiles, with either *Diadectes* or *Seymouria* as the transition. By the evolutionists’ own time scale, this “transition” occurs 35-million years (m.y.) **after** the earliest reptile, *Hylonomus* (a cotylosaur). A parent cannot appear 35-million years after its child! The scattered locations of these fossils also present problems for evolutionists.

[See Steven M. Stanley, *Earth and Life Through Time* (New York: W. H. Freeman and Co., 1986), pp. 411–415. See also

Robert H. Dott Jr. and Roger L. Batten, *Evolution of the Earth*, 3rd edition (New York: McGraw-Hill, 1981), p. 356.]

It is true that skeletal features of some amphibians and some reptiles are similar. However, huge differences exist in their soft internal organs, such as their circulatory and reproductive systems. For example, no evolutionary scheme has ever been given for the development of the many unique innovations of the reptile’s egg. [See Denton, pp. 218–219 and Pitman, pp. 199–200.]

Table 2. Reptile Transition?

What	Name	When	Where
Earliest Reptile	Hylonomus	lower Pennsylvanian 315 m.y.	Nova Scotia
Transition?	Diadectes	lower Permian 280 m.y.	Texas
Transition?	Seymouria	lower Permian 280 m.y.	Texas

- h. “*Gaps at a lower taxonomic level, species and genera, are practically universal in the fossil record of the mammal-like reptiles. In no single adequately documented case is it possible to trace a transition, species by species, from one genus to another.*” Thomas S. Kemp, *Mammal-Like Reptiles and the Origin of Mammals* (New York: Academic Press, 1982), p. 319.
- i. “*The [evolutionary] origin of birds is largely a matter of deduction. There is no fossil evidence of the stages through which the remarkable change from reptile to bird was achieved.*” W. E. Swinton, “The Origin of Birds,” *Biology and Comparative Physiology of Birds*, editor A. J. Marshall (New York: Academic Press, 1960), Vol. 1, Chapter 1, p. 1.
- ◆ Some have claimed birds evolved from a two-legged dinosaur known as a *theropod*. However, several problems exist.
 - ❖ A theropod dinosaur fossil found in China showed a lung mechanism completely incompatible with that of birds. [See John A. Ruben et al., “Lung Structure and Ventilation in Theropod Dinosaurs and Early Birds,” *Science*, Vol. 278, 14 November 1997, pp. 1267–1270.] In that report, “*Ruben argues that a transition from a crocodylian to a bird lung would be impossible, because the transitional animal would have a life-threatening hernia or hole in its diaphragm.*” [Ann Gibbons, “Lung Fossils Suggest Dinosaurs Breathed in Cold Blood,” *Science*, Vol. 278, 14 November 1997, p. 1230.]
 - ❖ Bird and theropod “hands” differ. Theropods have “fingers” I, II, and III (having lost the “ring finger” and little finger), while birds have fingers II, III, and IV. “*The developmental evidence of homology is problematic for the hypothesized theropod origin of birds.*” [Ann C. Burke and Alan Feduccia, “Developmental Patterns and the Identification of Homologies in the Avian Hand,” *Science*, Vol. 278, 24 October 1997, p. 668.] “*... this important developmental evidence that birds have a II-III-IV digital formula, unlike the dinosaur I-II-III, is the most important barrier to belief in the dinosaur origin [for birds] orthodoxy.*” [Richard Hinchliffe, “The Forward March of the Bird-Dinosaurs Halted?” *Science*, Vol. 278, 24 October 1997, p. 597.]
 - ❖ Theropod “arms” (relative to body size) are tiny, compared with the wings of supposedly early birds.

- ❖ "... most theropod dinosaurs and in particular the birdlike dromaeosaurs are all very much later in the fossil record than *Archaeopteryx* [the supposed first bird]." Hinchliffe, p. 597.
 - ❖ See "What Was *Archaeopteryx*?" on pages 464–467.
 - ❖ Birds have many unique features difficult to explain from any evolutionary perspective, such as feathers, tongues, and egg shell designs.
 - j. "When and where the first Primates made their appearance is also conjectural. ... It is clear, therefore, that the earliest Primates are not yet known ..." William Charles Osman Hill, *Primates* (New York: Interscience Publishers, Inc., 1953), Vol. 1, pp. 25–26.
 - ◆ "The transition from insectivore to primate is not clearly documented in the fossil record." A. J. Kelso, *Physical Anthropology*, 2nd edition (New York: J. B. Lippincott Co., 1974), p. 141.
 - ◆ "Modern apes, for instance, seem to have sprung out of nowhere. They have no yesterday, no fossil record. And the true origin of modern humans—of upright, naked, toolmaking, big-brained beings—is, if we are to be honest with ourselves, an equally mysterious matter." Lyall Watson, "The Water People," *Science Digest*, May 1982, p. 44.
 - k. "At any rate, modern gorillas, oranges and chimpanzees spring out of nowhere, as it were. They are here today; they have no yesterday, unless one is able to find faint foreshadowings of it in the dryopithecids." Donald Johanson and Maitland Edey, *Lucy: The Beginnings of Humankind* (New York: Simon and Schuster, 1981; reprint, New York: Warner Books, 1982), p. 363.
 - l. "It may, therefore, be firmly maintained that it is not even possible to make a caricature of an evolution out of palaeobiological facts. The fossil material is now so complete that it has been possible to construct new classes and the lack of transitional series cannot be explained as due to the scarcity of the material. The deficiencies are real; they will never be filled." Nilsson, p. 1212.
 - ◆ "... experience shows that the gaps which separate the highest categories may never be bridged in the fossil record. Many of the discontinuities tend to be more and more emphasized with increased collecting." Norman D. Newell (former Curator of Historical Geology at the American Museum of Natural History), "The Nature of the Fossil Record," *Adventures in Earth History*, editor Preston Cloud (San Francisco: W. H. Freeman and Co., 1970), pp. 644–645.
 - ◆ "A person may choose any group of animals or plants, large or small, or pick one at random. He may then go to a library and with some patience he will be able to find a qualified author who says that the evolutionary origin of that form is not known." Davidheiser, p. 302.
- On pages 303–309, Davidheiser, a Ph.D. zoologist and creationist, lists 75 other forms of life whose ancestry is unknown.

24. The Cambrian Explosion

- a. "There is another and allied difficulty, which is much more serious. I allude to the manner in which species belonging to several of the main divisions of the animal kingdom suddenly appear in the lowest known fossiliferous rocks." Darwin, *The Origin of Species*, p. 348.
- "The abrupt manner in which whole groups of species suddenly appear in certain formations, has been urged by several palaeontologists—for instance, by Agassiz, Pictet, and Sedgwick—as a fatal objection to the belief in the transmutation of species. If numerous species, belonging to the same genera or families, have really started into life at once, the fact would be fatal to the theory of evolution through natural selection." *Ibid.*, p. 344.
- "To the question why we do not find rich fossiliferous deposits belonging to these assumed earliest periods prior to the Cambrian system, I can give no satisfactory answer." *Ibid.*, p. 350.
- "The case at present must remain inexplicable, and may be truly urged as a valid argument against the views here entertained." *Ibid.*, p. 351.
- ◆ "The most famous such burst, the Cambrian explosion, marks the inception of modern multicellular life. Within just a few million years, nearly every major kind of animal anatomy appears in the fossil record for the first time ... The Precambrian record is now sufficiently good that the old rationale about undiscovered sequences of smoothly transitional forms will no longer wash." Stephen Jay Gould, "An Asteroid to Die For," *Discover*, October 1989, p. 65.
- ◆ "And we find many of them [Cambrian fossils] already in an advanced state of evolution, the very first time they appear. It as though they were just planted there, without any evolutionary history. Needless to say, this appearance of sudden planting has delighted creationists." Richard Dawkins, *The Blind Watchmaker* (London: W.W. Norton & Co., 1996), p. 229.
- ◆ Richard Monastersky, "Mysteries of the Orient," *Discover*, April 1993, pp. 38–48.
- ◆ "One of the major unsolved problems of geology and evolution is the occurrence of diversified, multicellular marine invertebrates in Lower Cambrian rocks on all the continents and their absence in rocks of greater age." Daniel I. Axelrod, "Early Cambrian Maine Fauna," *Science*, Vol. 128, 4 July 1958, p. 7.
- ◆ "Evolutionary biology's deepest paradox concerns this strange discontinuity. Why haven't new animal body plans continued to crawl out of the evolutionary cauldron during the past hundreds of millions of years? Why are the ancient body plans so stable?" Jeffrey S. Levinton, "The Big Bang of Animal Evolution," *Scientific American*, Vol. 267, November 1992, p. 84.
- ◆ "Granted an evolutionary origin of the main groups of animals, and not an act of special creation, the absence of any record whatsoever of a single member of any of the phyla in the PreCambrian rocks remains as inexplicable on orthodox grounds as it was to Darwin." T. Neville George, "Fossils in Evolutionary Perspective," *Science Progress*, Vol. 48, January 1960, p. 5.

- b. Strange Cambrian fossils, thought to exist only in the Burgess Shale of western Canada, have been discovered in southern China. See:
- ❖ L. Ramsköld and Hou Xianguang, “New Early Cambrian Animal and Onychophoran Affinities of Enigmatic Metazoans,” *Nature*, Vol. 351, 16 May 1991, pp. 225–228.
 - ❖ Jun-yuan Chen et al., “Evidence for Monophyly and Arthropod Affinity of Cambrian Giant Predators,” *Science*, Vol. 264, 27 May 1994, pp. 1304–1308.
- Evolving so many unusual animals during a geologic period is mind-boggling. But doing it twice in widely separated locations stretches credulity to the breaking point. According to the theory of plate tectonics, China and Canada were even farther apart during the Cambrian.
- c. “... *it is well known that the fossil record tells us nothing about the evolution of flowering plants.*” Corner, p. 100.
- ◆ A. K. Ghosh and A. Bose, “Occurrence of Microflora in the Salt Pseudomorph Beds, Salt Range, Punjab,” *Nature*, Vol. 160, 6 December 1947, pp. 796–797.
 - ◆ A. K. Ghosh, J. Sen, and A. Bose, “Evidence Bearing on the Age of the Saline Series in the Salt Range of the Punjab,” *Geological Magazine*, Vol. 88, March–April 1951, pp. 129–133.
 - ◆ J. Coates et al., “Age of the Saline Series in the Punjab Salt Range,” *Nature*, Vol. 155, 3 March 1945, pp. 266–267.
 - ◆ Clifford Burdick, in his doctoral research at the University of Arizona in 1964, made discoveries similar to those cited above. [See Clifford Burdick, “Microflora of the Grand Canyon,” *Creation Research Society Quarterly*, Vol. 3, May 1966, pp. 38–50.] Burdick was denied a doctor’s degree at the University of Arizona because of these discoveries. [See Jerry Bergman, “Clifford Burdick: Unjustly Expelled Twice,” Parts I and II, *Creation Matters*, September/October and July/August 2010.
- d. S. Leclercq, “Evidence of Vascular Plants in the Cambrian,” *Evolution*, Vol. 10, June 1956, pp. 109–114.
- e. John E. Repetski, “A Fish from the Upper Cambrian of North America,” *Science*, Vol. 200, 5 May 1978, pp. 529–531.
- ◆ “*Vertebrates and their progenitors, according to the new studies, evolved in the Cambrian, earlier than paleontologists have traditionally assumed.*” Richard Monastersky, “Vertebrate Origins: The Fossils Speak Up,” *Science News*, Vol. 149, 3 February 1996, p. 75.
 - ◆ “*Also, the animal explosion caught people’s attention when the Chinese confirmed they found a genus now called Yunnanzoon that was present in the very beginning. This genus is considered a chordate, and the phylum Chordata includes fish, mammals and man. An evolutionist would say the ancestor of humans was present then. Looked at more objectively, you could say the most complex animal group, the chordates, were represented at the beginning, and they did not go through a slow gradual evolution to become a chordate.*” Paul Chien (Chairman, Biology Department, University of San Francisco), “Explosion of Life,” www.origins.org/articles/chien_explosionoflife.html, p. 3. Interviewed 30 June 1997.
- ◆ “*At 530-million years, the 3-centimeter-long Haikouichthys appears to be the world’s oldest fish, while another new specimen, Myllokunmingia, has simpler gills and is more primitive. To Conway Morris and others, the presence of these jawless fish in the Early Cambrian suggests that the origin of chordates lies even farther back in time.*” Erik Stokstad, “Exquisite Chinese Fossils Add New Pages to Book of Life,” *Science*, Vol. 291, 12 January 2001, p. 233.
 - ◆ “*The [500] specimens [of fish] may have been buried alive, possibly as a result of a storm-induced burial. ... The possession of eyes (and probably nasal sacs) is consistent with Haikouichthys being a craniate, indicating that vertebrate evolution was well advanced by the Early Cambrian.*” D. G. Shu et al., “Head and Backbone of the Early Cambrian Vertebrate *Haikouichthys*,” *Nature*, Vol. 421, 30 January 2003, pp. 527, 529.
 - ◆ D. G. Shu et al., “Lower Cambrian Vertebrates from South China,” *Nature*, Vol. 402, 4 November 1999, pp. 42–46.
 - f. “*Compared with the 30 or so extant phyla, some people estimate that the Cambrian explosion may have generated as many as 100.*” Roger Lewin, “A Lopsided Look at Evolution,” *Science*, Vol. 241, 15 July 1988, p. 291.
 - ◆ “*A simple way of putting it is that currently we have about 38 phyla of different groups of animals, but the total number of phyla discovered during that period of time [Cambrian] (including those in China, Canada, and elsewhere) adds up to over 50 phyla. That means [there are] more phyla in the very, very beginning, where we found the first fossils [of animal life], than exist now.*” “*Stephen Jay Gould has referred to this as the reverse cone of diversity. The theory of evolution implies that things get more complex and get more and more diverse from one single origin. But the whole thing turns out to be reversed—we have more diverse groups in the very beginning, and in fact more and more of them die off over time, and we have less and less now.*” Chien, p. 2.
 - ◆ “*It was puzzling for a while because they [evolutionary paleontologists] refused to see that in the beginning there could be more complexity than we have now. What they are seeing are phyla that do not exist now—that’s more than 50 phyla compared to the 38 we have now.*” *Ibid.*, p. 3.
 - g. “*But whatever ideas authorities may have on the subject, the lung-fishes, like every other major group of fishes that I know, have their origins firmly based in nothing, a matter of hot dispute among the experts, each of whom is firmly convinced that everyone else is wrong ... I have often thought of how little I should like to have to prove organic evolution in a court of law.*” [emphasis in original] Errol White, “A Little on Lung-Fishes,” *Proceedings of the Linnean Society of London*, Vol. 177, Presidential Address, January 1966, p. 8.
 - ◆ “*The geological record has so far provided no evidence as to the origin of the fishes ...*” J. R. Norman, *A History of Fishes*, 3rd edition (New York: John Wiley & Sons, 1975), p. 343.

- ◆ “All three subdivisions of the bony fishes first appear in the fossil record at approximately the same time. They are already widely divergent morphologically, and they are heavily armored. How did they originate? What allowed them to diverge so widely? How did they all come to have heavy armor? And why is there no trace of earlier, intermediate forms?” Gerald T. Todd, “Evolution of the Lung and the Origin of Bony Fishes—A Causal Relationship?” *American Zoologist*, Vol. 20, No. 4, 1980, p. 757.
- h. Cloud and Glaessner, pp. 783–792.
 - i. “There are no fossils known that show what the primitive ancestral insects looked like ... Until fossils of these ancestors are discovered, however, the early history of the insects can only be inferred.” Peter Farb, *The Insects*, Life Nature Library (New York: Time, Inc., 1962), pp. 14–15.
 - ◆ “There is, however, no fossil evidence bearing on the question of insect origin; the oldest insects known show no transition to other arthropods.” Frank M. Carpenter, “Fossil Insects,” *Insects* (Washington, D.C.: U.S. Government Printing Office, 1952), p. 18.
 - j. “For the most part, an ant [trapped in amber] living 100-million years ago looks like an ant today.” Paul Tafforeau, as quoted by Amy Barth, *Discover*, July/August 2009, p. 38.
 - ◆ “At 230-million years old, the mite fossils are about 100-million years older than previous finds and indicate that mites’ basic body blueprint was built to last.” Meghan Rosen, “Amber-Tombed Mites Look Familiar: Oldest Arthropods Sealed in Resin Similar to Modern Forms,” *Science News*, Vol. 182, 6 October 2012, p. 14.
 - k. “If there has been evolution of life, the absence of the requisite fossils in the rocks older than the Cambrian is puzzling.” Marshall Kay and Edwin H. Colbert, *Stratigraphy and Life History* (New York: John Wiley & Sons, 1965), p. 103.
- b. Y. Kruzhilin and V. Ovcharov, “A Horse from the Dinosaur Epoch?” *Moskovskaya Pravda [Moscow Truth]*, 5 February 1984.
- c. Edwin D. McKee, *The Supai Group of Grand Canyon*, Geological Survey Professional Paper 1173 (Washington, D.C.: U.S. Government Printing Office, 1982), pp. 93–96, 100.
- d. Alexander Romashko, “Tracking Dinosaurs,” *Moscow News*, No. 24, 1983, p. 10. [For an alternate but equivalent translation published by an anti-creationist organization, see Frank Zindler, “Man—A Contemporary of the Dinosaurs?” *Creation/Evolution*, Vol. 6, No. 1, 1986, pp. 28–29.]
- e. Paul O. Rosnau et al., “Are Human and Mammal Tracks Found Together with the Tracks of Dinosaurs in the Kayenta of Arizona?” Parts I and II, *Creation Research Society Quarterly*, Vol. 26, September 1989, pp. 41–48 and December 1989, pp. 77–98.
- ◆ Jeremy Auldane et al., “More Human-Like Track Impressions Found with the Tracks of Dinosaurs in the Kayenta Formation at Tuba City, Arizona,” *Creation Research Society Quarterly*, Vol. 34, December 1997, pp. 133–146 and back cover.
- f. Andrew Snelling, “Fossil Bluff,” *Ex Nihilo*, Vol. 7, March 1985, p. 8.
- ◆ Carol Armstrong, “Florida Fossils Puzzle the Experts,” *Creation Research Society Quarterly*, Vol. 21, March 1985, pp. 198–199.
- ◆ Pat Shipman, “Dumping on Science,” *Discover*, December 1987, p. 64.
- g. Francis S. Holmes, *Phosphate Rocks of South Carolina and the “Great Carolina Marl Bed”* (Charleston, South Carolina: Holmes’ Book House, 1870).
- ◆ Edward J. Nolan, “Remarks on Fossils from the Ashley Phosphate Beds,” *Proceedings of the Academy of Natural Sciences of Philadelphia*, 1876, pp. 80–81.
- ◆ John Watson did extensive library research on the relatively unknown fossil discoveries in these beds. Their vast content of bones provides the rich phosphate content. Personal communications, 1992.
- h. A. C. Noé, “A Paleozoic Angiosperm,” *Journal of Geology*, Vol. 31, May–June 1923, pp. 344–347.
 - i. “A type of amber, thought to have been invented by flowering plants, may have been en vogue millions of years before those plants evolved ... When the researchers analyzed the amber, though, they discovered a chemical signature known only from the amber of flowering plants.” Rachel Ehrenberg, “Flowerless Plants Also Made Form of Fancy Amber,” *Science News*, Vol. 176, 24 October 2009, p. 5.
 - ◆ “[The Illinois amber] has a molecular composition that has been seen only from angiosperms, which appeared much later in the Early Cretaceous. ... [Amber resins] are so diverse that those from each plant species have a distinctive Py-GC-MS fingerprint that can be used to identify the plants that produced various ambers around the world.” David Grimaldi, “Pushing Back Amber Production,” *Science*, Vol. 326, 2 October 2009, p. 51.

25. Out-of-Sequence Fossils

- a. Walter E. Lammerts has published eight lists totaling almost 200 wrong-order formations in the United States alone. [See “Recorded Instances of Wrong-Order Formations or Presumed Overthrusts in the United States: Parts I–VIII,” *Creation Research Society Quarterly*, September 1984, p. 88; December 1984, p. 150; March 1985, p. 200; December 1985, p. 127; March 1986, p. 188; June 1986, p. 38; December 1986, p. 133; and June 1987, p. 46.]
- ◆ “In the fossil record, we are faced with many sequences of change: modifications over time from A to B to C to D can be documented and a plausible Darwinian interpretation can often be made after seeing the sequence. But the predictive (or postdictive) power of theory is almost nil.” David M. Raup, “Evolution and the Fossil Record,” *Science*, Vol. 213, 17 July 1981, p. 289.
- ◆ “Fossil discoveries can muddle our attempts to construct simple evolutionary trees—fossils from key periods are often not intermediates, but rather hodgepodes of defining features of many different groups.” Neil Shubin, “Evolutionary Cut and Paste,” *Nature*, Vol. 394, 2 July 1998, p. 12.

- j. R. M. Stainforth, "Occurrence of Pollen and Spores in the Roraima Formation of Venezuela and British Guiana," *Nature*, Vol. 210, 16 April 1966, pp. 292–294.
- ◆ A. K. Ghosh and A. Bose, pp. 796–797.
 - ◆ A. K. Ghosh and A. Bose, "Spores and Tracheids from the Cambrian of Kashmir," *Nature*, Vol. 169, 21 June 1952, pp. 1056–1057.
 - ◆ J. Coates et al., pp. 266–267.
- k. George F. Howe et al., "A Pollen Analysis of Hakatai Shale and Other Grand Canyon Rocks," *Creation Research Society Quarterly*, Vol. 24, March 1988, pp. 173–182.
- l. Stephen T. Hasiotis (paleobiologist, U.S. Geological Survey, Denver), Personal communication, 27 May 1995.
- ◆ Carl Zimmer, "A Secret History of Life on Land," *Discover*, February 1998, pp. 76–83.
- m. Dong Ren, "Flower-Associated Brachycera Flies as Fossil Evidence for Jurassic Angiosperm Origins," *Science*, Vol. 280, 3 April 1998, pp. 85–88.

26. Ape-Men?

- a. "... existing phylogenetic hypotheses about human evolution [based on skulls and teeth] are unlikely to be reliable." Mark Collard and Bernard Wood, "How Reliable Are Human Phylogenetic Hypotheses?" *Proceedings of the National Academy of Sciences*, Vol. 97, 25 April 2000, p. 5003.
- ◆ In 1995, nine anthropologists announced their discovery of early representatives of *Homo habilis* and *Homo ergaster* in China. [See Huang Wanpo et al., "Early Homo and Associated Artifacts from Asia," *Nature*, Vol. 378, 16 November 1995, pp. 275–278.] Fourteen years later the same journal published a retraction. The discovery was of a "mystery ape." [See Russell L. Ciochon, "The Mystery Ape of Pleistocene Asia," *Nature*, Vol. 459, 18 June 2009, pp. 910–911.]
- How many more mystery apes are there, and do they explain other so-called "ape-men"?
- ◆ "We have all seen the canonical parade of apes, each one becoming more human. We know that as a depiction of evolution, this line-up is tosh [tidy, but sheer nonsense]. Yet we cling to it. Ideas of what human evolution ought to have been like still colour our debates. ... almost every time someone claims to have found a new species of hominin, someone else refutes it. The species is said to be either a member of *Homo sapiens*, but pathological, or an ape." Henry Gee, "Crania with Clout," *Nature*, Vol. 478, 6 October 2011, p. 34.
- b. "Fossil evidence of human evolutionary history is fragmentary and open to various interpretations. Fossil evidence of chimpanzee evolution is absent altogether." Henry Gee, "Return to the Planet of the Apes," *Nature*, Vol. 412, 12 July 2001, p. 131.
- c. Lord Zuckerman candidly stated that if special creation did not occur, then no scientist could deny that man evolved from some apelike creature "without leaving any fossil traces of the steps of the transformation." Solly Zuckerman (former Chief Scientific Advisor to the British Government and Honorary Secretary of the Zoological Society of London), *Beyond the Ivory Tower* (New York: Taplinger Publishing Co., 1970), p. 64.
- ◆ Bowden, pp. 56–246.
 - ◆ Duane T. Gish, *Battle for Creation*, Vol. 2, editor Henry M. Morris (San Diego: Creation-Life Publishers, 1976), pp. 193–200, 298–305.
- d. Speaking of Piltdown man, Lewin admits a common human problem even scientists have:
- How is it that trained men, the greatest experts of their day, could look at a set of modern human bones—the cranial fragments—and “see” a clear simian signature in them; and “see” in an ape’s jaw the unmistakable signs of humanity? The answers, inevitably, have to do with the scientists’ expectations and their effects on the interpretation of data.* Lewin, *Bones of Contention*, p. 61.
- ◆ At least eleven people have been accused of being the perpetrator of the famous Piltdown hoax. These included Charles Dawson, Pierre Teilhard de Chardin, and Sir Arthur Conan Doyle, creator of Sherlock Holmes.
- The hoaxer may have been Martin A. C. Hinton, who had a reputation as a practical joker and worked in the British Museum (Natural History) when Piltdown man was discovered. In the mid-1970s, an old trunk, marked with Hinton's initials, was found in the museum's attic. The trunk contained bones stained and carved in the same detailed way as the Piltdown bones. [For details, see Henry Gee, "Box of Bones 'Clinches' Identity of Piltdown Palaeontology Hoaxer," *Nature*, Vol. 381, 23 May 1996, pp. 261–262.]
- e. Allen L. Hammond, "Tales of an Elusive Ancestor," *Science* 83, November 1983, pp. 37, 43.
- f. Adrienne L. Zihlman and J. Lowenstein, "False Start of the Human Parade," *Natural History*, Vol. 88, August–September 1979, pp. 86–91.
- g. Hammond, p. 43.
- ◆ "The dethroning of *Ramapithecus*—from putative [supposed] first human in 1961 to extinct relative of the orangutan in 1982—is one of the most fascinating, and bitter, sagas in the search for human origins." Lewin, *Bones of Contention*, p. 86.
- h. "A single small water-worn tooth, 10.5 mm by 11 mm in crown diameter, signals the arrival of a member of the family of anthropoid Primates in North America in Middle Pliocene time." Henry Fairfield Osborn, "Hesperopithecus, the First Anthropoid Primate Found in America," *Proceedings of the National Academy of Sciences of the United States of America*, Vol. 8, 15 August 1922, p. 245.
- i. Java man consisted of two bones found about 39 feet apart: a skull cap and femur (thighbone). Rudolf Virchow, the famous German pathologist, believed that the femur was from a gibbon. By concurring, Dubois supported his own non-Darwinian theory of evolution—a theory too complex and strange to discuss here.

- Whether the bones were from a large-brained gibbon, a hominid, another animal, or two completely different animals is not the only issue. This episode shows how easily the person, who knew the bones best, could shift his interpretation from Java “man” to Java “gibbon.” When evidence is so fragmentary, many interpretations are possible.
- ◆ “*Pithecanthropus* [Java man] was not a man, but a gigantic genus allied to the Gibbons, superior to its near relatives on account of its exceedingly large brain volume, and distinguished at the same time by its erect attitude.” Eugene Dubois, “On the Fossil Human Skulls Recently Discovered in Java and Pithecanthropus Erectus,” *Man*, Vol. 37, January 1937, p. 4.
- “Thus the evidence given by those five new thigh bones of the morphological and functional distinctness of *Pithecanthropus erectus* furnishes proof, at the same time, of its close affinity with the gibbon group of anthropoid apes.” *Ibid.*, p. 5.
- ◆ “The success of Darwinism was accompanied by a decline in scientific integrity ... A striking example, which has only recently come to light, is the alteration of the Piltdown skull so that it could be used as evidence for the descent of man from the apes; but even before this a similar instance of tinkering with evidence was finally revealed by the discoverer of *Pithecanthropus* [Java man], who admitted, many years after his sensational report, that he had found in the same deposits bones that are definitely human.” W. R. Thompson, p. 17.
- W. R. Thompson, in his “Introduction to *The Origin of Species*” by Charles Darwin, refers to Dubois’ discovery in November 1890 of part of a lower jaw containing the stump of a tooth. This was found at Kedung-Brubus (also spelled *Kedeong Broboes*), 25 miles east of his find of Java “man” at Trinil, eleven months later. Dubois was confident it was a human jaw of Tertiary age. [See Herbert Wendt, *In Search of Adam* (Westport, Connecticut: Greenwood Publishers, 1955), pp. 293–294.] Dubois’ claims of finding “the missing link” would probably have been ignored if he had mentioned this jaw. Similar, but less convincing, charges have been made against Dubois concerning his finding of obvious human skulls at Wadjak, 60 miles from Trinil.
- ◆ C. L. Brace and Ashley Montagu, *Human Evolution*, 2nd edition (New York: Macmillan Publishing Co., 1977), p. 204.
 - ◆ Bowden, pp. 138–142, 144–148.
 - ◆ Hitching, pp. 208–209.
 - ◆ Patrick O’Connell, *Science of Today and the Problems of Genesis*, 2nd edition (Roseburg, Oregon: self-published, 1969), pp. 139–142.
 - j. *Ibid.*, pp. 108–138.
 - ◆ Bowden, pp. 90–137.
 - ◆ Marcellin Boule and Henri V. Vallois, *Fossil Men* (New York: The Dryden Press, 1957), p. 145.
 - k. “[The reanalysis of Narmada Man] puts another nail in the coffin of *Homo erectus* as a viable taxon.” Kenneth A. R. Kennedy, as quoted in “*Homo Erectus* Never Existed?” *Geotimes*, October 1992, p. 11.
 - l. “One researcher began her talk with a call for ‘a moment of silence for the death of *H. heidelbergensis*.’ Michael Balter, “RIP for a Key Homo Species?” *Science*, Vol. 345, 11 July 2014, p. 129.
 - m. Donald C. Johanson et al., “New Partial Skeleton of *Homo Habilis* from Olduvai Gorge, Tanzania,” *Nature*, Vol. 327, 21 May 1987, pp. 205–209.
 - n. “We present a revised definition, based on verifiable criteria, for *Homo* and conclude that two species, *Homo habilis* and *Homo rudolfensis*, do not belong in the [Homo] genus.” Bernard Wood and Mark Collard, “The Human Genus,” *Science*, Vol. 284, 2 April 1999, p. 65.
 - o. Dr. Charles Oxnard and Sir Solly Zuckerman, referred to below, were leaders in the development of a powerful multivariate analysis technique. A computer simultaneously performs millions of comparisons on hundreds of corresponding dimensions of the bones of living apes, humans, and australopithecines. Their verdict, that the australopithecines are not intermediate between man and living apes, is quite different from the more subjective and less-analytical visual techniques of most anthropologists. To my knowledge, this technique has not been applied to the most famous australopithecine, commonly known as “Lucy.”
 - ◆ “... the only positive fact we have about the Australopithecine brain is that it was no bigger than the brain of a gorilla. The claims that are made about the human character of the Australopithecine face and jaws are no more convincing than those made about the size of its brain. The Australopithecine skull is in fact so overwhelmingly simian as opposed to human that the contrary proposition could be equated to an assertion that black is white.” Zuckerman, p. 78.
 - ◆ “Let us now return to our original problem: the Australopithecine fossils. I shall not burden you with details of each and every study that we have made, but ... the conventional wisdom is that the Australopithecine fragments are generally rather similar to humans and when different deviate somewhat towards the condition in the African apes, the new studies point to different conclusions. The new investigations suggest that the fossil fragments are usually uniquely different from any living form ...” Charles E. Oxnard (Dean of the Graduate School, University of Southern California, Los Angeles, and from 1973 to 1978 a Dean at the University of Chicago), “Human Fossils: New Views of Old Bones,” *The American Biology Teacher*, Vol. 41, May 1979, p. 273.
 - ◆ Charles E. Oxnard, “The Place of the Australopithecines in Human Evolution: Grounds for Doubt?” *Nature*, Vol. 258, 4 December 1975, pp. 389–395.
 - ◆ “For my own part, the anatomical basis for the claim that the Australopithecines walked and ran upright like man is so much more flimsy than the evidence which points to the conclusion that their gait was some variant of what one sees in subhuman Primates, that it remains unacceptable.” Zuckerman, p. 93.
 - ◆ “His Lordship’s [Sir Solly Zuckerman’s] scorn for the level of competence he sees displayed by paleoanthropologists is legendary, exceeded only by the force of his dismissal of

the australopithecines as having anything at all to do with human evolution. 'They are just bloody apes,' he is reputed to have observed on examining the australopithecine remains in South Africa." Lewin, *Bones of Contention*, pp. 164–165.

- ◆ "This Australopithecine material suggests a form of locomotion that was not entirely upright nor bipedal. The Rudolf Australopithecines, in fact, may have been close to the 'knuckle-walker' condition, not unlike the extant African apes." Richard E. F. Leakey, "Further Evidence of Lower Pleistocene Hominids from East Rudolf, North Kenya," *Nature*, Vol. 231, 28 May 1971, p. 245.
- p. "Among the fossil hominids, the australopithecines show great-ape-like proportions [based on CAT scans of their inner ears] and *H. erectus* shows modern-human-like proportions." Fred Spoor et al., "Implications of Early Hominid Labyrinthine Morphology for Evolution of Human Bipedal Locomotion," *Nature*, Vol. 369, 23 June 1994, p. 646. [Many *H. erectus* bones are probably those of *H. sapiens*.]
- q. "The closest parallel today to the pattern of dental development of [australopithecines] is not in people but in chimpanzees." Bruce Bower, "Evolution's Youth Movement," *Science News*, Vol. 159, 2 June 2001, p. 347.
- r. William L. Jungers, "Lucy's Limbs: Skeletal Allometry and Locomotion in *Australopithecus Afarensis*," *Nature*, Vol. 297, 24 June 1982, pp. 676–678.
- ◆ Jeremy Cheras, "Trees Have Made Man Upright," *New Scientist*, Vol. 93, 20 January 1983, pp. 172–178.
- ◆ Jack T. Stern Jr. and Randall L. Susman, "The Locomotor Anatomy of *Australopithecus Afarensis*," *American Journal of Physical Anthropology*, Vol. 60, March 1983, pp. 279–317.
- s. Adrienne Zihlman, "Pigmy Chimps, People, and the Pundits," *New Scientist*, Vol. 104, 15 November 1984, pp. 39–40.
- t. Zeresenay Alemseged et al., "A Juvenile Early Hominin Skeleton from Dikika, Ethiopia," *Nature*, Vol. 443, 21 September 2006, pp. 296–301.
- u. "At present we have no grounds for thinking that there was anything distinctively human about australopithecine ecology and behavior. ... [T]hey were surprisingly apelike in skull form, premolar dentition, limb proportions, and morphology of some joint surfaces, and they may still have been spending a significant amount of time in the trees." Matt Cartmill et al., "One Hundred Years of Paleoanthropology," *American Scientist*, Vol. 74, July–August 1986, p. 417.
- ◆ "The proportions calculated for africanus turned out to be amazingly close to those of a chimpanzee, with big arms and small legs. ... 'One might say we are kicking Lucy out of the family tree,' says Berger." James Shreeve, "New Skeleton Gives Path from Trees to Ground an Odd Turn," *Science*, Vol. 272, 3 May 1996, p. 654.
- ◆ "There is indeed, no question which the Australopithecine skull resembles when placed side by side with specimens of human and living ape skulls. It is the ape—so much so that only detailed and close scrutiny can reveal any differences between them." Solly Zuckerman, "Correlation of Change in

the Evolution of Higher Primates," *Evolution as a Process*, editors Julian Huxley, A. C. Hardy, and E. B. Ford (London: George Allen and Unwin Ltd., 1954), p. 307.

"We can safely conclude from the fossil hominoid material now available that in the history of the globe there have been many more species of great ape than just the three which exist today." *Ibid.*, pp. 348–349.

- v. Francis Ivanhoe, "Was Virchow Right About Neanderthal?" *Nature*, Vol. 227, 8 August 1970, pp. 577–578.
- ◆ William L. Straus Jr. and A. J. E. Cave, "Pathology and the Posture of Neanderthal Man," *The Quarterly Review of Biology*, Vol. 32, December, 1957, pp. 348–363.
- ◆ Bruce M. Rothschild and Pierre L. Thillaud, "Oldest Bone Disease," *Nature*, Vol. 349, 24 January 1991, p. 288.
- w. Jack Cuozzo, *Buried Alive: The Startling Truth about Neanderthal Man* (Green Forest, Arkansas: Master Books, 1998).
- ◆ Jack Cuozzo, "Early Orthodontic Intervention: A View from Prehistory," *The Journal of the New Jersey Dental Association*, Vol. 58, No. 4, Autumn 1987, pp. 33–40.
- x. Boyce Rensberger, "Facing the Past," *Science* 81, October 1981, p. 49.

27. Fossil Man

- a. Bowden, pp. 78–79.
 - ◆ Frank W. Cousins, *Fossil Man* (Emsworth, England: A. E. Norris & Sons Ltd., 1971), pp. 48–50, 81.
 - ◆ Sir Arthur Keith correctly stated the dilemma evolutionists face with the Castenedolo skeletons.
As the student of prehistoric man reads and studies the records of the "Castenedolo" find, a feeling of incredulity rises within him. He cannot reject the discovery as false without doing an injury to his sense of truth, and he cannot accept it as a fact without shattering his accepted beliefs. Arthur Keith, *The Antiquity of Man* (London: Williams and Norgate, Ltd., 1925), p. 334.
- However, after examining the strata above and below the Castenedolo skeletons, and after finding no indication that they were intrusively buried, Keith surprisingly concluded that the enigma must be resolved by an intrusive burial. He justified this by citing the unfossilized condition of the bones. However, these bones were encased in a clay layer. Clay would prevent water from transporting large amounts of dissolved minerals into the bone cells and explain the lack of fossilization. Again, fossilization depends much more on chemistry than age.
- b. Bowden, pp. 183–193.
 - c. *Ibid.*, pp. 79–88.
 - ◆ J. D. Whitney, "The Auriferous Gravels of the Sierra Nevada of California," *Memoirs of the Museum of Comparative Zoology of Harvard College*, Vol. 6, 1880, pp. 258–288.

- ◆ Bowden, pp. 76–78.
- ◆ Cousins, pp. 50–52, 82, 83.
- ◆ W. H. B., “Alleged Discovery of An Ancient Human Skull in California,” *American Journal of Science*, Vol. 2, 1866, p. 424.
- ◆ Edward C. Lain and Robert E. Gentet, “The Case for the Calaveras Skull,” *Creation Research Society Quarterly*, Vol. 33, March 1997, pp. 248–256.
- ◆ Cousins and Whitney state that the Calaveras skull was fossilized. This does not mean that it was pre-flood. Fossilization depends on chemistry much more than time.

For many years, a story circulated that the Calaveras skull, buried 130 feet below ground, was a practical joke. This tidy explanation conveniently overlooks hundreds of human bones and artifacts (such as spearheads, mortars and pestles, and dozens of bowls made of stone) found in that part of California. These artifacts have been found over the years under undisturbed strata and a layer of basaltic lava that evolutionists would date at 25-million years old—too old to be human. See, for example:

 - ❖ Whitney, pp. 262–264, 266, 274–276.
 - ❖ G. Frederick Wright, *Man and the Glacial Period* (New York: D. Appleton and Co., 1897), pp. 294–301.
 - ❖ George F. Becker, “Antiquities from under Tuolumne Table Mountain in California,” *Bulletin of the Geological Society of America*, Vol. 2, 20 February 1891, pp. 189–200.
- d. Fix, pp. 98–105.
- ◆ J. B. Birdsell, *Human Evolution* (Chicago: Rand McNally, 1972), pp. 316–318.

28. Chemical Elements of Life

- a. The four most abundant chemical elements, by weight, in the human body are oxygen (65%), carbon (18%), hydrogen (10%), and nitrogen (3%).
- b. Carbon is only the 18th most abundant element, by weight, in the Earth’s crust. Furthermore, almost all carbon is tied up in organic matter, such as coal and oil, or in sediments deposited after life began, such as limestone or dolomite.
- c. “*The cause of the initial rise in oxygen concentration presents a serious and unresolved quantitative problem.*” Leigh Van Valen, “The History and Stability of Atmospheric Oxygen,” *Science*, Vol. 171, 5 February 1971, p. 442.
- d. Since 1930, knowledgeable evolutionists have realized that life could not have evolved in the presence of oxygen. [See “*Proteins*” on page 15.] If the atmosphere had no oxygen as life evolved, how did the atmosphere get its oxygen?

Cyanobacteria break down carbon dioxide and water and release oxygen. In 1987, William J. Schopf claimed that he and his graduate student had discovered fossils of 3.4-billion-year-old cyanobacteria. This, he said, is how the atmosphere gained its oxygen after these bacteria—shielded by a shallow sea from ultraviolet radiation—

evolved. Evolutionists eagerly accepted this long-awaited discovery as a key part of their theory of how life evolved.

Schopf’s former graduate student and other experts have now charged Schopf with withholding evidence that those fossils were *not* cyanobacteria. Most experts feel betrayed by Schopf, who now accepts that his “*specimens were not oxygen-producing cyanobacteria after all.*” [See Rex Dalton, “Squaring Up over Ancient Life,” *Nature*, Vol. 417, 20 June 2002, p. 783.] A foundational building block in the evolution story—that had become academic orthodoxy—has crumbled.

- e. Hitching, p. 65.
- f. “*If there ever was a primitive soup [to provide the chemical compounds for evolving life], then we would expect to find at least somewhere on this planet either massive sediments containing enormous amounts of the various nitrogenous organic compounds, amino acids, purines, pyrimidines and the like, or alternatively in much metamorphosed sediments we should find vast amounts of nitrogenous cokes. In fact no such materials have been found anywhere on earth. Indeed to the contrary, the very oldest of sediments ... are extremely short of nitrogen.*” J. Brooks and G. Shaw, *Origin and Development of Living Systems* (New York: Academic Press, 1973), p. 359.
- ◆ “*No evidence exists that such a soup ever existed.*” Abel and Trevors, p. 3.
- g. “*How this nitrogen fixing root nodule (NFN) symbiosis arose repeatedly during plant evolution is an age-old mystery.*” ... “*the likelihood of parallel changes affecting tens to hundreds of the same genes is so low that multiple independent origins seem implausible.*” Laszlo Nagy, “Many Roads to Convergence,” *Science*, Vol. 361, 13 July 2018, p. 125–126.
- h. “*The acceptance of this theory [life’s evolution on Earth] and its promulgation by many workers [scientists and researchers] who have certainly not always considered all the facts in great detail has in our opinion reached proportions which could be regarded as dangerous.*” *Ibid.*, p. 355.

Certainly, ignoring indisputable, basic evidence in most scientific fields is expensive and wasteful. Failure to explain the evidence to students betrays a trust and misleads future teachers and leaders.

Readers should consider why, despite the improbabilities and lack of proper chemistry, many educators and the media have taught for a century that life evolved on Earth.

Abandoning or questioning that belief leaves only one strong contender—creation. Questioning evolution in some circles invites ostracism, much like stating that the proverbial emperor “has no clothes.”

29. Proteins

- a. An authoritative study concluded that the early biosphere contained oxygen before the earliest fossils (bacteria) formed. Iron oxides were found that “*imply a source of oxygen enough to convert into insoluble ferric material the ferrous solutions that must have first formed the flat, continuous horizontal*

- layers that can in some sites be traced over hundreds of kilometers.” Philip Morrison, “Earth’s Earliest Biosphere,” *Scientific American*, Vol. 250, April 1984, pp. 30–31.
- ◆ Charles F. Davidson, “Geochemical Aspects of Atmospheric Evolution,” *Proceedings of the National Academy of Sciences*, Vol. 53, 15 June 1965, pp. 1194–1205.
 - ◆ Steven A. Austin, “Did the Early Earth Have a Reducing Atmosphere?” *ICR Impact*, No. 109, July 1982.
 - ◆ “In general, we find no evidence in the sedimentary distributions of carbon, sulfur, uranium, or iron, that an oxygen-free atmosphere has existed at any time during the span of geological history recorded in well-preserved sedimentary rocks.” Erich Dimroth and Michael M. Kimberley, “Precambrian Atmospheric Oxygen: Evidence in the Sedimentary Distributions of Carbon, Sulfur, Uranium, and Iron,” *Canadian Journal of Earth Sciences*, Vol. 13, September 1976, p. 1161.
 - ◆ “What is the evidence for a primitive methane-ammonia atmosphere on earth? The answer is that there is **no** evidence for it, but much against it.” [emphasis in original] Philip H. Abelson, “Chemical Events on the Primitive Earth,” *Proceedings of the National Academy of Sciences*, Vol. 55, June 1966, p. 1365.
 - b. R. T. Brinkmann, “Dissociation of Water Vapor and Evolution of Oxygen in the Terrestrial Atmosphere,” *Journal of Geophysical Research*, Vol. 74, 20 October 1969, pp. 5355–5368.
 - c. “It is difficult to imagine how a little pond with just these components, and no others [no contaminants], could have formed on the primitive earth. Nor is it easy to see exactly how the precursors would have arisen.” Francis Crick, *Life Itself* (New York: Simon and Schuster, 1981), p. 85.
 - d. “But when multiple biopolymers must all converge at the same place at the same time to collectively interact in a controlled biochemical cooperative manner, faith in ‘self-organization’ becomes ‘blind belief. No empirical data or rational scientific basis exists for such a metaphysical leap.” Abel and Trevors, p. 9.
 - e. “I believe this [the overwhelming tendency for chemical reactions to move in the direction opposite to that required for the evolution of life] to be the most stubborn problem that confronts us—the weakest link at present in our argument [for the origin of life].” George Wald, “The Origin of Life,” p. 50.
 - f. “The conclusion from these arguments presents the most serious obstacle, if indeed it is not fatal, to the theory of spontaneous generation. First, thermodynamic calculations predict vanishingly small concentrations of even the simplest organic compounds. Secondly, the reactions that are invoked to synthesize such compounds are seen to be much more effective in decomposing them.” D. E. Hull, “Thermodynamics and Kinetics of Spontaneous Generation,” *Nature*, Vol. 186, 28 May 1960, p. 694.
 - ◆ Pitman, p. 140.
 - ◆ Duane T. Gish, *Speculations and Experiments Related to Theories on the Origin of Life*, ICR Technical Monograph, No. 1 (El Cajon, California: Institute for Creation Research, 1972).
 - g. “An honest man, armed with all the knowledge available to us now, could only state that in some sense, the origin of life appears at the moment to be almost a miracle, so many are the conditions which would have had to have been satisfied to get it going.” Crick, p. 88.
- Francis Crick, a Nobel Prize winner and co-discoverer of the DNA molecule, did not give up. He reasoned that if life could not have evolved on Earth, it must have evolved elsewhere in our galaxy and been transported to Earth—an old theory called *panspermia*. Just how life evolved on a distant planet is never explained. Crick proposed *directed panspermia*—that an *advanced civilization* sent bacteria to Earth. Crick (p. 15) recognized that “it is difficult to see how viable spores could have arrived here, after such a long journey in space, undamaged by radiation.” He mistakenly thought that a spacecraft might protect the bacteria from cosmic radiation. Crick grossly underestimated the problem. [See Eugene N. Parker, “Shielding Space Travelers,” *Scientific American*, Vol. 294, March 2006, pp. 40–47.]
- h. Robert Shapiro, *Origins* (New York: Bantam Books, 1986).
 - ◆ The experiments by Harold Urey and Stanley Miller are often mentioned as showing that the “building blocks of life” can be produced in the laboratory. Not mentioned in these misleading claims are:
 - ❖ Organic molecules in life are of two types: proteins and nucleic acids (DNA and RNA). Nucleic acids, which contain vast amounts of incredibly complex information, were not produced, nor would any knowledgeable person expect them to be produced.
 - ❖ The protein “building blocks” were merely the simpler amino acids. More complex amino acids have never been produced in the laboratory. (In 2011, several more amino acids were found in Miller’s old experimental materials, but the more complex amino acids found in life were still missing. See Eric T. Parker et al., “Primordial Synthesis of Amines and Amino Acids in a 1958 Miller H₂S-Rich Spark Discharge Experiment,” *Proceedings of the National Academy of Sciences*, 21 March 2011, pp. 1–6.)
 - ❖ Most products of these chemical reactions are poisonous to life.
 - ❖ Amino acids are as far from a living cell as bricks are from the Empire State Building.
 - ❖ Half the amino acids produced have the wrong handedness. [See “**Handedness: Left and Right**” on page 18.]
 - ❖ Urey and Miller’s experiments contained a reducing atmosphere, which the early Earth did not have (see Endnote “a” above), and components, such as a trap, that do not exist in nature. (A **trap** quickly removes fragile chemical products from the destructive energy sources that make the products.)
- All of the above show why intelligence and design are necessary to produce even the simplest components of life.
- ◆ “The story of the slow paralysis of research on life’s origin is quite interesting, but space precludes its retelling here. Suffice

it to say that at present the field of origin-of-life studies has dissolved into a cacophony of conflicting models, each unconvincing, seriously incomplete, and incompatible with competing models. In private even most evolutionary biologists will admit that science has no explanation for the beginning of life.” Behe, “Molecular Machines,” pp. 30–31.

- ◆ Rick Pierson, “Life before Life,” *Discover*, August 2004, p. 8.
- i. Endnote 7 on page 512 explains how incredibly small and numerous ribosomes are.
- j. “The ribosome, the machine that makes proteins, itself consists of lots of proteins. So how could the ribosome have even come into existence?” Venki Ramakrishnan, *Gene Machine* (New York: Basic books, 2018), p. 71.

Ramakrishnan attempts to answer his questions by saying there must have been primitive ribosomes that are no longer present.

30. The First Cell

- a. “Among the great scientific puzzles of our time is how life emerged from inorganic matter.” Sara Imari Walker, “A new Lens on Life’s Origins,” *Nature*, Vol.569, 2 May 2019, p. 36.
- ◆ “.Biology is the study of complicated things that give the appearance of having been designed for a purpose. Dawkins, *The Blind Watchmaker*, p. 1.

Yet, after such acknowledgments, Dawkins, an avowed atheist and perhaps the world’s leading Darwinian, tries to show that life came about by natural processes, not intelligent design. Dawkins fails to grasp the complexity in life.

- ◆ *We have seen that living things are too improbable and too beautifully ‘designed’ to have come into existence by chance.”* Ibid, p. 43.

Here Dawkins states that natural selection, not chance, accounts for this “apparent” design. While natural selection accounts for microevolution, it certainly cannot produce macroevolution. [See “[Natural Selection](#)” on page 6.]

- ◆ “The complexity of the simplest known type of cell is so great that it is impossible to accept that such an object could have been thrown together suddenly by some kind of freakish, vastly improbable, event. Such an occurrence would be indistinguishable from a miracle.” Denton, p. 264.

“Is it really credible that random processes could have constructed a reality, the smallest element of which—a functional protein or gene—is complex beyond our own creative capacities, a reality which is the very antithesis of chance, which excels in every sense anything produced by the intelligence of man? Alongside the level of ingenuity and complexity exhibited by the molecular machinery of life, even our most advanced artefacts appear clumsy. We feel humbled, as neolithic man would in the presence of twentieth-century technology. It would be an illusion to think that what we are aware of at present is any more than a fraction of the full extent of biological design. In practically every field of fundamental biological research ever-increasing levels of design and complexity are being revealed at an ever-accelerating rate.” Ibid., p. 342.

- ◆ “We have seen that self-replicating systems capable of Darwinian evolution appear too complex to have arisen suddenly from a prebiotic soup. This conclusion applies both to nucleic acid systems and to hypothetical protein-based genetic systems.” Shapiro, p. 207.

“We do not understand how this gap in organization was closed, and this remains the most crucial unsolved problem concerning the origin of life.” Ibid., p. 299.

- ◆ “More than 30 years of experimentation on the origin of life in the fields of chemical and molecular evolution have led to a better perception of the immensity of the problem of the origin of life on Earth rather than to its solution. At present all discussions on principal theories and experiments in the field either end in stalemate or in a confession of ignorance.” Klaus Dose, “The Origin of Life: More Questions Than Answers,” *Interdisciplinary Science Reviews*, Vol. 13, No. 4, 1988, p. 348.
- b. “The events that gave rise to that first primordial cell are totally unknown, matters for guesswork and a standing challenge to scientific imagination.” Lewis Thomas, foreword to *The Incredible Machine*, editor Robert M. Pool (Washington, D.C.: National Geographic Book Service, 1986), p. 7.
- ◆ “No experimental system yet devised has provided the slightest clue as to how biologically meaningful sequences of subunits might have originated in prebiotic polynucleotides or polypeptides.” Kenyon, p. A-20.
- ◆ “If we can indeed come to understand how a living organism arises from the nonliving, we should be able to construct one—only of the simplest description, to be sure, but still recognizably alive. This is so remote a possibility now that one scarcely dares to acknowledge it; but it is there nevertheless.” George Wald, “The Origin of Life,” p. 45.
- ◆ Experts in this field hardly ever discuss publicly how the first cell could have evolved. However, the world’s leading evolutionists know the problems. For example, on 27 July 1979, Luther D. Sunderland taped an interview with Dr. David Raup, Dean of the Field Museum of Natural History in Chicago. This interview was later transcribed and authenticated by both parties. Sunderland told Raup, “Neither Dr. Patterson [of the British Museum (Natural History)] nor Dr. Eldredge [of the American Museum of Natural History] could give me any explanation of the origination of the first cell.” Dr. Raup replied, “I can’t either.”
- ◆ “However, the macromolecule-to-cell transition is a jump of fantastic dimensions, which lies beyond the range of testable hypothesis. In this area all is conjecture. The available facts do not provide a basis for postulating that cells arose on this planet.” David E. Green and Robert F. Goldberger, *Molecular Insights Into the Living Process* (New York: Academic Press, 1967), pp. 406–407.
- ◆ “Every time I write a paper on the origins of life I swear I will never write another one, because there is too much speculation running after too few facts, though I must confess that in spite of this, the subject is so fascinating that I never seem to stick to my resolve.” Crick, p. 153.

This fascination explains why the “origin of life” topic frequently arises—despite so much evidence showing that it cannot happen by natural processes. Speculations abound.

31. Barriers, Buffers, and Chemical Pathways

- a. This delicate chemical balance, upon which life depends, was explained to me by biologist Terrence R. Mondy.
- b. Behe, pp. 77–97.

32. Genetic Distances

- a. Dr. Colin Patterson—Senior Principal Scientific Officer in the Palaeontology Department at the British Museum (Natural History)—gave a talk on 5 November 1981 to leading evolutionists at the American Museum of Natural History. He compared amino acid sequences in several proteins of different animals. The relationships of these animals, according to evolutionary theory, have been taught in classrooms for decades. Patterson explained to a stunned audience that this new information contradicts the theory of evolution. In his words, *“The theory makes a prediction; we’ve tested it, and the prediction is falsified precisely.”* Although he acknowledged that scientific falsification is never absolute, he admitted, *“evolution was a faith,”* he was *“duped into taking evolutionism as revealed truth in some way,”* and *“evolution not only conveys no knowledge but seems somehow to convey anti-knowledge, apparent knowledge which is harmful to systematics [the science of classifying different forms of life].”* “Prominent British Scientist Challenges Evolution Theory,” Audio Tape Transcription and Summary by Luther D. Sunderland, Personal communication. For other statements from Patterson’s presentation, see Tom Bethell, “Agnostic Evolutionists,” *Harper’s Magazine*, February 1985, pp. 49–61.
 - ◆ *“... it seems disconcerting that many exceptions exist to the orderly progression of species as determined by molecular homologies ...”* Christian Schwabe, “On the Validity of Molecular Evolution,” *Trends in Biochemical Sciences*, July 1986, p. 280.

“It appears that the neo-darwinian hypothesis is insufficient to explain some of the observations that were not available at the time the paradigm [the theory of evolution] took shape. ... One might ask why the neo-darwinian paradigm does not weaken or disappear if it is at odds with critical factual information. The reasons are not necessarily scientific ones but rather may be rooted in human nature.” Ibid., p. 282.
 - ◆ *“Evolutionary trees constructed by studying biological molecules often don’t resemble those drawn up from morphology.”* Trisha Gura, “Bones, Molecules ... or Both?” *Nature*, Vol. 406, 20 July 2000, p. 230.
- b. R. B. Brown, *Abstracts: 31st International Science and Engineering Fair* (Washington, D.C.: Science Service, 1980), p. 113.
 - ◆ Ginny Gray, “Student Project ‘Rattles’ Science Fair Judges,” *Issues and Answers*, December 1980, p. 3.

- ◆ While the rattlesnake’s cytochrome c was most similar to man’s, man’s cytochrome c was most similar to that of the rhesus monkey. (If this seems like a contradiction, consider that City A could be the closest city to City B, but City C might be the closest city to City A.)
- c. *“As morphologists with high hopes of molecular systematics, we end this survey with our hopes dampened. Congruence between molecular phylogenies is as elusive as it is in morphology and as it is between molecules and morphology.”* Colin Patterson et al., p. 179.
- d. Gregory J. Brewer, “The Imminent Death of Darwinism and the Rise of Intelligent Design,” *ICR Impact*, No. 341, November 2001, pp. 1–4.
 - ◆ Field, pp. 748–753.
 - e. Denton, p. 285.
 - f. *“The really significant finding that comes to light from comparing the proteins’ amino acid sequences is that it is impossible to arrange them in any sort of evolutionary series.”* Ibid., p. 289.

“Thousands of different sequences, protein and nucleic acid, have now been compared in hundreds of different species but never has any sequence been found to be in any sense the lineal descendant or ancestor of any other sequence.” Ibid., pp. 289–290.

“Each class at a molecular level is unique, isolated and unlinked by intermediates. Thus molecules, like fossils, have failed to provide the elusive intermediates so long sought by evolutionary biology.” Ibid., p. 290.

“There is little doubt that if this molecular evidence had been available one century ago it would have been seized upon with devastating effect by the opponents of evolution theory like Agassiz and Owen, and the idea of organic evolution might never have been accepted.” Ibid., pp. 290–291.

“In terms of their biochemistry, none of the species deemed ‘intermediate’, ‘ancestral’ or ‘primitive’ by generations of evolutionary biologists, and alluded to as evidence of sequence in nature, show any sign of their supposed intermediate status.” Ibid., p. 293.
- g. After sequencing just the first chimpanzee chromosome, surprises were apparent.

Surprisingly, though, nearly 68,000 stretches of DNA do differ to some degree between the two species ... Extra sections of about 300 nucleotides showed up primarily in the human chromosome ... Extra sections of other sizes—some as long as 54,000 nucleotides—appear in both species. Bruce Bower, “Chimp DNA Yields Complex Surprises,” *Science News*, Vol. 165, 12 June 2004, p. 382.

 - ◆ *“Indeed, 83% of the 231 coding sequences, including functionally important genes, show differences [even] at the amino acid sequence level. ... the biological consequences due to the genetic differences are much more complicated than previously speculated.”* H. Watanabe et al., “DNA Sequence and Comparative Analysis of Chimpanzee Chromosome 22,” *Nature*, Vol. 429, 27 May 2004, pp. 382, 387.

- h. Tarjei S. Mikkelsen et al., “Initial Sequence of the Chimpanzee Genome and Comparison with the Human Genome,” *Nature*, Vol. 437, 1 September 2005, p. 69.
- i. “*Surprisingly, however, >30% of chimpanzee MSY [male-specific portion of the Y chromosome] sequence has no homologous, alignable counterpart in the human MSY, and vice versa. ... Moreover, the MSY sequences retained in both lineages have been extraordinarily subject to rearrangement ...*” Jennifer F. Hughes et al., “Chimpanzee and Human Y Chromosomes Are Remarkably Divergent in Structure and Gene Content,” *Nature*, Vol. 463, 28 January 2010, p. 537.
- j. “*... the difference in MSY gene content in chimpanzee and human is more comparable to the difference in autosomal gene content in chicken and human, at 310-million years of separation.*” *Ibid.*, p. 538.
- k. “*Studying human and Western chimpanzees, we found no hotspot sharing between the two species.*” Adam Auton et al., “A fine-Scale Chimpanzee Genetic Map from Population Sequencing,” *Science*, Vol. 336, 13 April 2012, p. 196.
- ♦ “*Chimpanzees’ shuffling pattern is similar to that seen in some previously studied organisms, while the human pattern is unusual ...*” Gil McVean, as quoted by Tina Hesman Saey, “Going Ape Offers Better Family Tree,” *Science News*, Vol. 181, 21 April 2012, p. 16.
- l. “*Instead, the comparisons [using DNA] have yielded many versions of the tree of life that differ from the rRNA tree and conflict with each other as well.*” Elizabeth Pennisi, “Is It Time to Uproot the Tree of Life?” *Science*, Vol. 284, 21 May 1999, p. 1305.
- ♦ “*We are left with a conundrum. [Evolutionary trees based on bodily characteristics (morphology) differ from trees based on genetics.]*” Jonathan B. Losos et al., “Who Speaks with a Forked Tongue?” *Science*, Vol. 338, 14 December 2012, p. 1429.

“Follow the Money” on page 16

- a. Governmental agencies are by far the biggest funding source. And yet, they seldom can account for or justify years later the billions of dollars they spent.

*The group queried 24 government agencies [in the U.K.] to find out how they publish and archive research that they commission. Only four departments maintained a data base of their research; 11 could not create an inventory of what they had supported, mostly because no central records exist. Agency confusion over when research reports should be published has resulted in what the group calls “ghost research” that is “unsearchable in the national archives and exists only in the memories of officials.” The report also described examples of delays in releasing the results of what it called “politically awkward” studies. John Travis, “U.K. Loses Too Much Research,” *Science*, Vol. 352, 10 June 2016, p. 1257.*

The United States government has this problem as well.

- b. Lynn Margulis, as quoted by Dick Teresi, “Lynn Margulis,” *Discover*, April 2011, p. 71.

“The Elephant in the Living Room” on page 17

- a. George V. Caylor, “The Biologist,” *The Ledger*, Vol. 2, Issue 48, No. 92, 1 December 2000, p. 2. (www.ontherightside.com) Printed with permission.

33. Genetic Information

- a. Carl Sagan showed, using simple calculations, why one cell’s worth of genetic information approximates 4,000 books of printed information. Each of Sagan’s 4,000 books had 500 pages with 300 words per page. [See Carl Sagan, *The Dragons of Eden* (New York: Random House, 1977), p. 25.] Each book would have a volume of about 50 cubic inches. An adult human’s body contains about 30 trillion (3×10^{13}) cells. [See R. Sender et al., *Nature*, Vol. 529, 14 January 2016, p. 132.] About 800 cubic miles have been eroded from the Grand Canyon. Therefore, if the DNA in every cell in one person’s body were reduced to 4,000 books, they would fill the Grand Canyon 30 times

$$\frac{3 \times 10^{13} \times 4,000 \times 50 \text{ inches}^3}{800 \text{ mile}^3} \times \left(\frac{\text{mile}}{5,280 \times 12 \text{ inches}} \right)^3 = 30$$

The Moon is 240,000 miles from Earth. If the DNA in a human cell were stretched out and connected, it would be 7 feet long. If all the DNA in one person’s body were placed end-to-end, it would extend to the Moon 165,000 times.

$$\frac{3 \times 10^{13} \times 7 \text{ feet}}{240,000 \text{ miles}} \times \frac{\text{mile}}{5,280 \text{ feet}} = 165,000$$

The DNA in a human cell weighs 6.4×10^{-12} grams. [See Monroe W. Strickberger, *Genetics*, 2nd edition (New York: Macmillan Publishing Co., 1976), p. 54.] Probably less than 50 billion people have lived on Earth. If so, one copy of the DNA of every human who ever lived—enough to define the physical characteristics of all those people in microscopic detail—would weigh only

$$6.4 \times 10^{-12} \times 50 \times 10^9 = 0.32 \text{ grams}$$

This is less than the weight of one aspirin.

- ♦ “*... there is enough information capacity in a single human cell to store the Encyclopaedia Britannica, all 30 volumes of it, three or four times over. ... There is enough storage capacity in the DNA of a single lily seed or a single salamander sperm to store the Encyclopaedia Britannica 60 times over. Some species of the unjustly called ‘primitive’ amoebas have as much information in their DNA as 1,000 Encyclopaedia Britannicas.*” Dawkins, *The Blind Watchmaker*, pp. 116–117.
- b. These letters, called bases, are of four types—abbreviated A, C, G, and T. They are frequently shown as the rungs on a twisted ladder—the ladder representing the DNA molecule.

- c. Johan H. Gibcus, et al., “A Pathway for Mitotic Chromosome Formation,” *Science*, Vol. 359, 9 February 2018, p. 652.
- d. Cees Dekker, “DNA Looper Caught on Film,” *Science*, Vol. 555, 1 March 2018, p. 9.
- e. “*What is actually powering the loop formation, he adds, ‘has got to be the biggest problem in genome biology right now.’* Kim Nasmyth, as quoted by Elie Dolgin, in “A Loop of Faith,” *Nature*, Vol. 544, 20 April, 2017, p. 285.
- ◆ Siyuan Wang, et al., “Spatial Organization of Chromatin Domains and Compartments in Single Chromosomes,” *Science*, Vol. 353, pp. 598–602.
- f. “*... the human genome is over 2 m in length and yet it is packed into a cellular compartment that is merely about 10 μm in diameter.*” Daniel R. Larson and Tom Misteli, “The Genome—Seeing it Clearly Now,” *Science*, Vol. 357, 28 July 2017, p. 354.
- g. “*Biochemical systems are exceedingly complex, so much so that the chance of their being formed through random shufflings of simple organic molecules is exceedingly minute, to a point indeed where it is insensibly different from zero.*” Hoyle and Wickramasinghe, p. 3.
- “*No matter how large the environment one considers, life cannot have had a random beginning. Troops of monkeys thundering away at random on typewriters could not produce the works of Shakespeare, for the practical reason that the whole observable universe is not large enough to contain the necessary monkey hordes, the necessary typewriters, and certainly the waste paper baskets required for the deposition of wrong attempts. The same is true for living material.*” Ibid., p. 148.
- Not mentioned by Hoyle and Wickramasinghe is the simple fact that even a few correct words typed by the hordes of monkeys would decay long before a complete sentence of Shakespeare was completed. Correspondingly, a few correct sequences of amino acids would decay long before a protein was completed, not to mention the thousands of proteins that must be in their proper place to have a living cell. Finally, the most complex requirement of all is the presence of functioning DNA.
- “*From the beginning of this book we have emphasized the enormous information content of even the simplest living systems. The information cannot in our view be generated by what are often called ‘natural’ processes, as for instance through meteorological and chemical processes occurring at the surface of a lifeless planet. As well as a suitable physical and chemical environment, a large initial store of information was also needed. We have argued that the requisite information came from an ‘intelligence’, the beckoning spectre.*” Ibid., p. 150.
- “*Once we see, however, that the probability of life originating at random is so utterly minuscule as to make the random concept absurd, it becomes sensible to think that the favourable properties of physics on which life depends are in every respect deliberate.*” Ibid., p. 141.
- Hoyle and Wickramasinghe also say that our own intelligences must reflect a vastly superior intelligence, “*even to the extreme idealized limit of God.*” They believe that life was created by some intelligence somewhere in outer space and later was transported to Earth. [emphasis in original] Ibid., p. 144.
- h. Murray Eden, as reported in “Heresy in the Halls of Biology: Mathematicians Question Darwinism,” *Scientific Research*, November 1967, p. 64.
- ◆ “*It is our contention that if ‘random’ is given a serious and crucial interpretation from a probabilistic point of view, the randomness postulate is highly implausible and that an adequate scientific theory of evolution must await the discovery and elucidation of new natural laws—physical, physico-chemical, and biological.*” Murray Eden, “Inadequacies of Neo-Darwinian Evolution as a Scientific Theory,” *Mathematical Challenges to the Neo-Darwinian Interpretation of Evolution*, editors Paul S. Moorhead and Martin M. Kaplan, June 1967, p. 109.
- i. “*The trouble is that there are about two thousand enzymes, and the chance of obtaining them all in a random trial is only one part in $(10^{20})^{2,000} = 10^{40,000}$, an outrageously small probability that could not be faced even if the whole universe consisted of organic soup. If one is not prejudiced either by social beliefs or by a scientific training into the conviction that life originated on the Earth [by chance or natural processes], this simple calculation wipes the idea entirely out of court.*” Hoyle and Wickramasinghe, p. 24.
- “*Any theory with a probability of being correct that is larger than one part in $10^{40,000}$ must be judged superior to random shuffling [of evolution]. The theory that life was assembled by an intelligence has, we believe, a probability vastly higher than one part in $10^{40,000}$ of being the correct explanation of the many curious facts discussed in preceding chapters. Indeed, such a theory is so obvious that one wonders why it is not widely accepted as being self-evident. The reasons are psychological rather than scientific.*” Ibid., p. 130.
- After explaining the above to a scientific symposium, Hoyle said that evolution was comparable with the chance that “*a tornado sweeping through a junk-yard might assemble a Boeing 747 from the materials therein.*” Fred Hoyle, “Hoyle on Evolution,” *Nature*, Vol. 294, 12 November 1981, p. 105.
- ◆ “*All point mutations that have been studied on the molecular level turn out to reduce the genetic information and not to increase it.*” Lee Spetner, *Not by Chance* (Brooklyn, New York: The Judaica Press, Inc., 1996), p. 138.
- j. See Susuma Ohno, “So Much ‘Junk’ DNA in Our Genome,” *The Brookhaven Symposium on Biology*, Vol. 23, 1972, pp. 366–370.
- Ohno’s catchy term “junk DNA” stuck and no doubt discouraged a generation of researchers from studying the vast amount of important “junk” DNA that did not code for proteins. (Who wants to study junk?) This is one example of the harm that evolution thinking has done to science. Nevertheless, the thrust of Ohno’s paper made an insightful point: If all the DNA “of man, mice, and other organisms” was useful, so many mutations would accumulate in hundreds

of millions of years that those species would become extinct. What Ohno overlooked is that life has not been on Earth for hundreds of millions of years. Belief in the supposedly old age of the Earth has also been harmful to science.

- ◆ Non-coding DNA differs more among different species than does protein coding DNA. Had the non-coding DNA received equal attention since 1972, the great dissimilarity between species would have been more apparent.

“So whereas if you find a particular protein-coding gene in a human, you’re going to find nearly the same gene in a mouse most of the time, and that rule just doesn’t work for regulatory elements [non-coding DNA].” [See Ewan Birney, “Journey to the Genetic Interior,” *Scientific American*, Vol. 307, October 2012, p. 82.]

- k. *“The failure to recognize the importance of introns [so-called junk DNA] may well go down as one of the biggest mistakes in the history of molecular biology.”* John S. Mattick, as quoted by W. Wayt Gibbs, “The Unseen Genome: Gems among the Junk,” *Scientific American*, Vol. 289, November 2003, pp. 49–50.

“What was damned as junk because it was not understood may, in fact, turn out to be the very basis of human complexity.” Ibid., p. 52.

- ◆ *“Noncoding RNAs (ncRNAs) [so-called junk RNA] have been found to have roles in a great variety of processes, including transcription regulation, chromosome replication, RNA processing and modification, messenger RNA stability and translation, and even protein degradation and translocation. Recent studies indicate that ncRNAs are far more abundant and important than initially imagined.”* Gisela Storz, “An Expanding Universe of Noncoding RNAs,” *Science*, Vol. 296, 17 May 2002, p. 1260.
- ◆ *“The term ‘junk DNA’ is a reflection of our ignorance.”* Gretchen Vogel, “Why Sequence the Junk?” *Science*, Vol. 291, 16 February 2001, p. 1184.
- ◆ *“... non-gene sequences [what evolutionists called ‘junk DNA’] have regulatory roles.”* John M. Greally, “Encyclopaedia of Humble DNA,” *Nature*, Vol. 447, 14 June 2007, p. 782.

- l. Brendan Maher, “The Human Encyclopedia,” *Nature*, Vol. 489, 6 September 2012, pp. 46–48.

This issue of *Nature* contains six of the 30 papers explaining the discoveries of the ENCODE (Encyclopedia of DNA Elements) project, conducted by more than 500 international scientists beginning in 2003. Their discoveries will revolutionize our understanding of the vast complexity of the human genome. The other papers are published in *Genome Research* and *Genome Biology*.

- ◆ Gary Taubes, “RNA Revolution,” *Discover*, October 2009, pp. 47–52.

having a right-handed configuration. All nucleotides synthesized biologically today are right-handed. Yet on the primitive earth, equal numbers of right- and left-handed nucleotides would have been present.” Leslie E. Orgel, “The Origin of Life on the Earth,” *Scientific American*, Vol. 271, October 1994, p. 82.

- ◆ *“There is no explanation why cells use L [left-handed] amino acids to synthesize their proteins but D [right-handed] ribose or D-deoxyribose to synthesize their nucleotides or nucleic acids. In particular, the incorporation of even a single L-ribose or L-deoxyribose residue into a nucleic acid, if it should ever occur in the course of cellular syntheses, could seriously interfere with vital structure-function relationships. The well-known double helical DNA structure does not allow the presence of L-deoxyribose; the replication and transcription mechanisms generally require that any wrong sugar such as L-deoxyribose has to be eliminated, that is, the optical purity of the D-sugars units has to be 100%.”* Dose, p. 352.
- b. An important exception occurs in a component in cell membranes of eubacteria. There, the amino acids are right-handed. This has led many to conclude that they must have evolved separately from all other bacteria. Because evolving the first living cell is so improbable, having it happen twice, in effect, compounds the improbability. [See Adrian Barnett, “The Second Coming: Did Life Evolve on Earth More Than Once?” *New Scientist*, Vol. 157, 14 February 1998, p. 19.]
- c. Recent discoveries have found that some amino acids, most notably aspartic acid, flip (at certain locations in certain proteins) from the normal left-handed form to the right-handed form. Flipping increases with age and correlates with disease, such as Alzheimer’s disease, cataracts, and arteriosclerosis. As one ages, flipping even accumulates in facial skin, but not other skin. [See Noriko Fujii, “D-Amino Acid in Elderly Tissues,” *Biological and Pharmaceutical Bulletin*, Vol. 28, September 2005, pp. 1585–1589.]

If life evolved, why did this destructive tendency to flip not destroy cells long before complete organisms evolved?

- d. *“Many researchers have attempted to find plausible natural conditions under which [left-handed] L-amino acids would preferentially accumulate over their [right-handed] D-counterparts, but all such attempts have failed. Until this crucial problem is solved, no one can say that we have found a naturalistic explanation for the origin of life. Instead, these isomer preferences point to biochemical creation.”* Kenyon, p. A-23.
- ◆ Evolutionists who work in this field are continually seeking a solution. Occasionally, someone claims that it has been solved, but only after checking the details does one find that the problem remains. In Germany, in 1994, a doctoral candidate, Guido Zadel, claimed he had solved the problem. Supposedly, a strong magnetic field will bias a reaction toward either the left-handed or right-handed form. Origin-of-life researchers were excited. Zadel’s doctorate was awarded. At least 20 groups then tried to duplicate his results, always unsuccessfully. Later, Zadel admitted that he had dishonestly manipulated his data. [See Daniel Clery and

34. Handedness: Left and Right

- a. *“Equally disappointing, we can induce copying of the original template only when we run our experiments with nucleotides*

David Bradley, "Underhanded 'Breakthrough' Revealed," *Science*, Vol. 265, 1 July 1994, p. 21.]

- ◆ James F. Coppedge, *Evolution: Possible or Impossible?* (Grand Rapids: Zondervan Publishing House, 1973), pp. 71–79.
- ◆ A. E. Wilder-Smith, *The Natural Sciences Know Nothing of Evolution* (San Diego: Master Book Publishers, 1981), pp. 15–32, 154–160.
- ◆ Dickerson, p. 76.

35. Metamorphosis

- a. "Certainly it [metamorphosis] demonstrates the absurdity of invoking natural selection by successive mutation to explain such an obviously, yet subtly programmed, process. Why on that basis, should the ancestral insect have survived the mutations that projected it into the chrysalid stage, from which it could not yet develop into an adult? Where was natural selection then? How could pre-programmed metamorphosis, in insect, amphibian or crustacean, ever have evolved by chance? Indeed, how could development have evolved piece-meal? The ball is in the evolutionist's court, tangled in a net of inexplicability." Pitman, p. 71.
 - ◆ "Apart from the many difficulties in understanding how such a radical change [as metamorphosis] comes about, there is the larger question of why it should happen. Can there really be an evolutionary advantage in constructing one sort of organism and then throwing it away and starting again?" Taylor, p. 177.
 - ◆ "There is no evidence of how such a remarkable plan of life [metamorphosis] ever came about ..." Peter Farb, *The Insects*, Life Nature Library (New York: Time, Inc., 1962), p. 56.
 - ◆ "Does any one really believe that the ancestors of butterflies were as adults just masses of pulp enveloped in cases, having no means of procuring external nourishment? If not, it is for the evolutionist to explain how the process of metamorphosis became intercalated in the life-history of the caterpillar." Douglas Dewar, *The Transformist Illusion* (Murfreesboro, Tennessee: DeHoff Publications, 1957), p. 213.
 - ◆ Finding how metamorphosis evolved in one species, genus, family, order, or class is just the first question. Because many different larva-to-adult patterns exist, many other explanations are also needed.
- b. Pitman, pp. 193–194.
 - c. Christine Merlin et al., "Antennal Circadian Clocks Coordinate Sun Compass Orientation in Migratory Monarch Butterflies," *Science*, Vol. 325, 25 September 2009, pp. 1700–1704.
 - ◆ Jules H. Poirier, *From Darkness to Light to Flight: Monarch—the Miracle Butterfly* (El Cajon, California: Institute for Creation Research, 1995).
 - d. An evolutionist might claim that larvae once reproduced, but then lost that capability. If so, why is there no sign of any remnant reproductive equipment in any of the hundreds of thousands of larva types?

- e. Charles Darwin, *The Origin of Species*, 6th edition (New York: Macmillan Publishing Co., 1927), p. 179.

36. DNA and Proteins

- a. Ribosomes, complex structures that assemble proteins, have or require about 200 different proteins. The number depends somewhat on whether the organism is a bacterium, eukaryote, or archaea.
- b. Richard E. Dickerson, "Chemical Evolution and the Origin of Life," *Scientific American*, Vol. 239, September 1978, p. 73.
- ◆ "The amino acids must link together to form proteins, and the other chemicals must join up to make nucleic acids, including the vital DNA. The seemingly insurmountable obstacle is the way the two reactions are inseparably linked—one can't happen without the other. Proteins depend on DNA for their formation. But DNA cannot form without pre-existing protein." Hitching, p. 66.
- c. "The origin of the genetic code presents formidable unsolved problems. The coded information in the nucleotide sequence is meaningless without the translation machinery, but the specification for this machinery is itself coded in the DNA. Thus without the machinery the information is meaningless, but without the coded information the machinery cannot be produced! This presents a paradox of the 'chicken and egg' variety, and attempts to solve it have so far been sterile." John C. Walton, (Lecturer in Chemistry, University of St. Andrews, Fife, Scotland), "Organization and the Origin of Life," *Origins*, Vol. 4, No. 1, 1977, pp. 30–31.
- ◆ "Genes and enzymes are linked together in a living cell—two interlocked systems, each supporting the other. It is difficult to see how either could manage alone. Yet if we are to avoid invoking either a Creator or a very large improbability, we must accept that one occurred before the other in the origin of life. But which one was it? We are left with the ancient riddle: Which came first, the chicken or the egg?" Shapiro, p. 135.
- ◆ "Because DNA and proteins depend so intimately on each other for their survival, it's hard to imagine one of them having evolved first. But it's just as implausible for them to have emerged simultaneously out of a prebiotic soup." Carl Zimmer, "How and Where Did Life on Earth Arise?" *Science*, Vol. 309, 1 July 2005, p. 89.
- d. DNA produces protein-based enzymes that speed chemical reactions and synthesize lipids that are needed to create cell membranes that protect DNA and their products.
- e. "Of the nearly 1.7 million people diagnosed with cancer each year in the United States alone, about half have mutated versions of p53—a sign of how important the normal protein is in preventing the disease." Robert F. Service, "Rescuing the Guardian of the Genome," *Science*, Vol. 354, 7 October 2016, p. 27.
- ◆ Mitch Leslie, "Brothers in Arms Against Cancer," *Science*, Vol. 331, 25 March 2011, pp. 1551–1552.
- ◆ Erika Check Hayden, "Life Is Complicated," *Nature*, Vol. 464, 1 April 2010, pp. 664–667.

- f. "... the human body receives tens of thousands of DNA lesions per day." Stephen P. Jackson and Jiri Bartek, "The DNA-Damage Response in Human Biology and Disease," *Nature*, Vol. 461, 22 October 2009, p. 1071.
- g. DNA behaves like a wire and conducts electricity. If the DNA is damaged or its bases are paired up incorrectly, its electrical conductivity drops sharply. Pairs of repair proteins travel along a DNA strand and can thereby pinpoint any decrease in electrical resistance between them. [See Robert F. Service, "Live Wire," *Science*, Vol. 346, 12 December 2014, pp. 1284–1285.]
- h. Tomas Lindahl and Richard D. Wood, "Quality Control by DNA Repair," *Science*, Vol. 286, 3 December 1999, pp. 1897–1905.
- i. Charles Boone and Brenda J. Andrews, "The Indispensable Genome," *Science*, Vol. 350, 27 November 2015, pp. 1028–1029.

37. Sexual Reproduction

- a. In humans and in all mammals, a mother's immune system, contrary to its normal function, must learn not to attack her unborn baby—half of whom is a "foreign body" from the father. If these immune systems functioned "properly," mammals—including each of us—would not exist.
The mysterious lack of rejection of the fetus has puzzled generations of reproductive immunologists and no comprehensive explanation has yet emerged. [Charles A. Janeway Jr. et al., *Immuno Biology* (London: Current Biology Limited, 1997), p. 12:24.]
- b. N. W. Pixie, "Boring Sperm," *Nature*, Vol. 351, 27 June 1991, p. 704.
- c. Meredith Gould and Jose Luis Stephano, "Electrical Responses of Eggs to Acrosomal Protein Similar to Those Induced by Sperm," *Science*, Vol. 235, 27 March 1987, pp. 1654–1656.
- ◆ "When egg meets sperm in mammals, zinc sparks fly. ... [They] are needed to stimulate the transition from egg to embryo." Ashley Yeager, "Images Reveal Secrets of Zinc Sparks," *Science News*, Vol. 187, 10 January 2015, p. 14.
- d. For example, how could meiosis evolve?
- e. "But the sex-determination genes in the fruit fly and the nematode are completely unrelated to each other, let alone to those in mammals." Jean Marx, "Tracing How the Sexes Develop," *Science*, Vol. 269, 29 September 1955, p. 1822.
- f. "This book is written from a conviction that the prevalence of sexual reproduction in higher plants and animals is inconsistent with current evolutionary theory." George C. Williams, *Sex and Evolution* (Princeton, New Jersey: Princeton University Press, 1975), p. v.
- ◆ "So why is there sex? We do not have a compelling answer to the question. Despite some ingenious suggestions by orthodox Darwinians (notably G. C. Williams, 1975; John Maynard Smith, 1978), there is no convincing Darwinian history for the emergence of sexual reproduction. However, evolutionary

theorists believe that the problem will be solved without abandoning the main Darwinian insights—just as early nineteenth-century astronomers believed that the problem of the motion of Uranus could be overcome without major modification of Newton's celestial mechanics." Philip Kitcher, *Abusing Science: The Case Against Creationism* (Cambridge, Massachusetts: The MIT Press, 1982), p. 54.

- ◆ "The evolution of sex is one of the major unsolved problems of biology. Even those with enough hubris to publish on the topic often freely admit that they have little idea of how sex originated or is maintained. It is enough to give heart to creationists." Michael Rose, "Slap and Tickle in the Primeval Soup," *New Scientist*, Vol. 112, 30 October 1986, p. 55.
- ◆ "Indeed, the persistence of sex is one of the fundamental mysteries in evolutionary biology today." Gina Maranto and Shannon Brownlee, "Why Sex?" *Discover*, February 1984, p. 24.
- ◆ "Sex is something of an embarrassment to evolutionary biologists. Textbooks understandably skirt the issue, keeping it a closely guarded secret." Kathleen McAuliffe, "Why We Have Sex," *Omni*, December 1983, p. 18.
- ◆ "From an evolutionary viewpoint the sex differentiation is impossible to understand, as well as the structural sexual differences between the systematic categories which are sometimes immense. We know that intersexes [organisms that are partly male and partly female] within a species must be sterile. How is it, then, possible to imagine bridges between two amazingly different structural types?" Nilsson, p. 1225.
- ◆ "One idea those attending the sex symposium seemed to agree on is that no one knows why sex persists." [According to evolution, it should not.] Gardiner Morse, "Why Is Sex?" *Science News*, Vol. 126, 8 September 1984, p. 155.
- g. "In the discipline of developmental biology, creationist and mechanist concur except on just one point—a work of art, a machine or a body which can reproduce itself cannot first make itself." Pitman, p. 135.

38. Symbiotic Relationships

- a. Oscar L. Brauer, "The Smyrna Fig Requires God for Its Production," *Creation Research Society Quarterly*, Vol. 9, September 1972, pp. 129–131.
- ◆ Bob Devine, *Mr. Baggy-Skin Lizard* (Chicago: Moody Press, 1977), pp. 29–32.
- b. Jerry A. Powell and Richard A. Mackie, *Biological Interrelationships of Moths and Yucca Whipplei* (Los Angeles: University of California Press, 1966).

39. Immune Systems

- a. "We can look high or we can look low, in books or in journals, but the result is the same. The scientific literature has no answers to the question of the origin of the immune system." Behe, p. 138.

- ◆ “Unfortunately, we cannot trace most of the evolutionary steps that the immune system took. Virtually all the crucial developments seem to have happened at an early stage of vertebrate evolution, which is poorly represented in the fossil record and from which few species survive. Even the most primitive extant vertebrates seem to rearrange their antigen receptor genes and possess separate T and B cells, as well as MHC molecules. Thus has the immune system sprung up fully armed.” Avrion Mitchison, “Will We Survive?” *Scientific American*, Vol. 269, September 1993, p. 138.

40. Improbabilities

- a. Coppedge, pp. 71–72.
- ◆ “Whether one looks to mutations or gene flow for the source of the variations needed to fuel evolution, there is an enormous probability problem at the core of Darwinist and neo-Darwinist theory, which has been cited by hundreds of scientists and professionals. Engineers, physicists, astronomers, and biologists who have looked without prejudice at the notion of such variations producing ever more complex organisms have come to the same conclusion: The evolutionists are assuming the impossible. Even if we take the simplest large protein molecule that can reproduce itself if immersed in a bath of nutrients, the odds against this developing by chance range from one in 10^{450} (engineer Marcel Goulay in *Analytical Chemistry*) to one in 10^{600} (Frank Salisbury in *American Biology Teacher*.)” Fix, p. 196.
 - ◆ “I don’t know how long it is going to be before astronomers generally recognize that the combinatorial arrangement of not even one among the many thousands of biopolymers on which life depends could have been arrived at by natural processes here on the Earth. Astronomers will have a little difficulty at understanding this because they will be assured by biologists that it is not so, the biologists having been assured in their turn by others that it is not so. The ‘others’ are a group of persons who believe, quite openly, in mathematical miracles. They advocate the belief that tucked away in nature, outside of normal physics, there is a law which performs miracles (provided the miracles are in the aid of biology). This curious situation sits oddly on a profession that for long has been dedicated to coming up with logical explanations of biblical miracles.” Fred Hoyle, “The Big Bang in Astronomy,” *New Scientist*, Vol. 92, 19 November 1981, p. 526.
 - ◆ “The origin of life by chance in a primeval soup is impossible in probability in the same way that a perpetual motion machine is impossible in probability. ... A practical person must conclude that life didn’t happen by chance.” Hubert P. Yockey, *Information Theory and Molecular Biology* (Cambridge, UK: Cambridge University Press, 1992), p. 257.
- b. Harold J. Morowitz, *Energy Flow in Biology: Biological Organization as a Problem in Thermal Physics* (New York: Academic Press, 1968), pp. 2–12, 44–75.

41. Living Technology

- a. “Life implies movement. Most forms of movement in the living world are powered by tiny protein machines known as molecular motors.” Manfred Schliwa and Günther Woehlke, “Molecular Motors,” *Nature*, Vol. 422, 17 April 2003, p. 759.
- b. “We would see [in cells] that nearly every feature of our own advanced machines had its analogue in the cell: artificial languages and their decoding systems, memory banks for information storage and retrieval, elegant control systems regulating the automated assembly of parts and components, error fail-safe and proof-reading devices utilized for quality control, assembly processes involving the principle of prefabrication and modular construction. In fact, so deep would be the feeling of *deja-vu*, so persuasive the analogy, that much of the terminology we would use to describe this fascinating molecular reality would be borrowed from the world of late twentieth-century technology.
 “What we would be witnessing would be an object resembling an immense automated factory, a factory larger than a city and carrying out almost as many unique functions as all the manufacturing activities of man on earth. However, it would be a factory which would have one capacity not equalled in any of our own most advanced machines, for it would be capable of replicating its entire structure within a matter of a few hours. To witness such an act at a magnification of one thousand million times would be an awe-inspiring spectacle.” Denton, p. 329.
- c. “Ounce for ounce, watt for watt, it [the bat] is millions of times more efficient and more sensitive than the radars and sonars contrived by man.” Pitman, p. 219.
- d. For years, Dr. Duane Gish told a humorous story about the bombardier beetle (BB). It defends itself by shooting hot (212°F) irritating gases out of twin combustion tubes in its tail. Each tube carries a different chemical: hydrogen peroxide in one and hydroquinone in the other. When they combine—after exiting the tubes and just before striking the face of BB’s enemy—they explode. How then did this evolve inside that poor beetle without killing him? Even if BB figured out the chemistry before a predator killed him, BB’s defensive system wouldn’t work until (1) the tubes were designed to avoid the corrosive chemicals, (2) the muscles in BB’s body could quickly rotate his “guns” up to 360° (3) his eyes and brain worked well enough to accurately aim his “guns,” and (4) his muscles “could pull the trigger.

Some who have never had to design anything, might think that with billions of years and thousands of mutations, a normal beetle might become BB. However, when so many components are involved, nothing works until every component works—simultaneously. With each failure, the whole evolutionary process must begin again. [See Duane T. Gish, “*The Amazing Story of Creation*,” (El Cajon, CA, Institute for Creation Research, 1990), pp. 96–101.]

Scientists have recently learned that BB can survive even if a predator swallows him. BB survives “being eaten by squirting a boiling-hot chemical over predator’s innards, causing the

predator to vomit” and expel BB. [See ‘Beetles Cause Indigestion,’ *Nature*, Vol. 554, 15 February 2018, p. 279.]

I once ordered a dramatic picture, for use in this book. It showed BB shooting his “guns at a menacing toad. After offering to pay the dealer his asking price, the dealer asked if I was a creationist. I said I was. He then said he was not allowed to sell that picture to any creationists. Can you guess why?

- ◆ Robert E. Kofahl and Kelly L. Segraves, *The Creation Explanation* (Wheaton, Illinois: Harold Shaw Publishers, 1975), pp. 2–9.
- ◆ Thomas Eisner and Daniel J. Aneshansley, “Spray Aiming in Bombardier Beetles: Jet Deflection by the Coanda Effect,” *Science*, Vol. 215, 1 January 1982, pp. 83–85.
- ◆ Behe, pp. 31–36.
- e. Jason A. Etheredge et al., “Monarch Butterflies (*Danaus plexippus* L.) Use a Magnetic Compass for Navigation,” *Proceedings of the National Academy of Sciences*, Vol. 96, 23 November 1999, pp. 13845–13846.
- f. David H. Freedman, “Exploiting the Nanotechnology of Life,” *Science*, Vol. 254, 29 November 1991, pp. 1308–1310.
- ◆ Tom Koppel, “Learning How Bacteria Swim Could Set New Gears in Motion,” *Scientific American*, Vol. 265, September 1991, pp. 168–169.
- ◆ Howard C. Berg, “How Bacteria Swim,” *Scientific American*, Vol. 233, August 1975, pp. 36–44.
- g. Y. Magariyama et al., “Very Fast Flagellar Rotation,” *Nature*, Vol. 371, 27 October 1994, p. 752.
- h. Could a conventional electrical motor be scaled down to propel a bacterium through a liquid? No. Friction would overcome almost all movement, because the ratio of inertial-to-viscous forces is proportional to scale. In effect, the liquid becomes stickier the smaller you get. Therefore, the efficiency of the bacterial motor itself, which approaches 100% at slow speeds, is remarkable and currently unexplainable.
- i. C. Wu, “Protein Switch Curls Bacterial Propellers,” *Science News*, Vol. 153, 7 February 1998, p. 86.
- j. Yes, you read this correctly. The molecular motors are 25 nanometers in diameter while an average human hair is about 75 microns in diameter.
- k. “*Bacteria can organize into groups, they can communicate. ... How could this have evolved?*” E. Peter Greenberg, “Tiny Teamwork,” *Nature*, Vol. 424, 10 July 2003, p. 134.
- ◆ Bonnie L. Bassler, “How Bacteria Talk to Each Other: Regulation of Gene Expression by Quorum Sensing,” *Current Opinion in Microbiology*, Vol. 2, 1 December 1999, pp. 582–587.
- l. “*... the smallest rotary motors in biology. The flow of protons propels the rotation ...*” Holger Seelert et al., “Proton-Powered Turbine of a Plant Motor,” *Nature*, Vol. 405, 25 May 2000, pp. 418–419.

- ◆ “*The ATP synthase [motor] not only lays claim to being nature’s smallest rotary motor, but also has an extremely important role in providing most of the chemical energy that aerobic and photosynthetic organisms need to stay alive.*” Richard L. Cross, “Turning the ATP Motor,” *Nature*, Vol. 427, 29 January 2004, pp. 407–408.

42. The Validity of Thought

- a. “*But then arises the doubt, can the mind of man, which has, as I fully believe, been developed from a mind as low as that possessed by the lowest animals, be trusted when it draws such grand conclusions? I cannot pretend to throw the least light on such abstruse problems.*” Charles Darwin, *The Life and Letters*, Vol. 1, p. 313.
- ◆ “*For if my mental processes are determined wholly by the motions of atoms in my brain, I have no reason to suppose that my beliefs are true. They may be sound chemically, but that does not make them sound logically. And hence I have no reason for supposing my brain to be composed of atoms.*” J. B. S. Haldane, *Possible Worlds* (London: Chatto & Windus, 1927), p. 209.
- ◆ “*If the solar system was brought about by an accidental collision, then the appearance of organic life on this planet was also an accident, and the whole evolution of Man was an accident too. If so, then all our present thoughts are mere accidents—the accidental by-product of the movement of atoms. And this holds for the thoughts of the materialists and astronomers as well as for anyone else’s. But if their thoughts—i.e. of Materialism and Astronomy—are merely accidental by-products, why should we believe them to be true? I see no reason for believing that one accident should be able to give me a correct account of all the other accidents.*” C. S. Lewis, *God In the Dock* (Grand Rapids: Eerdmans Publishing Co., 1970), pp. 52–53.
- ◆ “*Each particular thought is valueless if it is the result of irrational causes. Obviously, then, the whole process of human thought, what we call Reason, is equally valueless if it is the result of irrational causes. Hence every theory of the universe which makes the human mind a result of irrational causes is inadmissible, for it would be a proof that there are no such things as proofs. Which is nonsense. But Naturalism [evolution], as commonly held, is precisely a theory of this sort.*” C. S. Lewis, *Miracles* (New York: Macmillan Publishing Co., 1947), p. 21.
- ◆ C. S. Lewis, “The Funeral of a Great Myth,” *Christian Reflections* (Grand Rapids: Eerdmans Publishing Co., 1968), p. 89.
- ◆ “*If the universe is a universe of thought, then its creation must have been an act of thought.*” James H. Jeans, *The Mysterious Universe*, new revised edition (New York: Macmillan Publishing Co., 1932), p. 181.
- ◆ “*A theory that is the product of a mind can never adequately explain the mind that produced the theory. The story of the great scientific mind that discovers absolute truth is satisfying*

only so long as we accept the mind itself as a given. Once we try to explain the mind as a product of its own discoveries, we are in a hall of mirrors with no exit.” Phillip E. Johnson, *Reason in the Balance: The Case Against Naturalism in Science, Law & Education* (Downers Grove, Illinois: InterVarsity Press, 1995), p. 62.

- ◆ “One of the absurdities of materialism [the belief that nothing exists except the material] is that it assumes that the world can be rationally comprehensible only if it is entirely the product of irrational, unguided mechanisms.” Phillip E. Johnson, “The Wedge in Evolutionary Ideology: Its History, Strategy, and Agenda,” *Theology Matters*, Vol. 5, March/April 1999, p. 5.

Phillip E. Johnson has also made the point that intelligence might produce intelligence. However, for lifeless, inorganic matter to produce intelligence, as the theory of evolution claims, would be an astounding miracle.

- b. Phillip Johnson, “The Demise of Naturalism,” *World*, 3 April 2004, p. 38.
- c. “Behind Darwin’s discomfiture [on how the human brain evolved] was the dawning realization that the evolution of the brain vastly exceeded the needs of prehistoric man. This is, in fact, the only example in existence where a species was provided with an organ that it still has not learned how to use.” Richard M. Restak, *The Brain: The Last Frontier* (Garden City, New York: Doubleday & Co., Inc., 1979), p. 59.
- ◆ Alfred Russel Wallace, who some mistakenly say co-discovered (with Charles Darwin) natural selection, believed the human brain was too complex to have evolved, because other primates got along fine with much smaller brains. Wallace thought the human brain—orders of magnitude more capable in many ways—must have been created by a superior intelligence, because early primates had no need for art, philosophy, or morality. Darwin recognized the logic of Wallace’s argument, but complained in a letter to Wallace in 1869, “I hope you have not murdered too completely your own and my child [the theory of evolution].” [See James Marchant, *Alfred Russel Wallace: Letters and Reminiscences* (New York: Harper & Brothers, 1916), p. 240.]

Actually, Edward Blyth, a creationist, discovered natural selection, not Wallace or Darwin. [See “Natural Selection” on page 52.]

- d. Albert Einstein, “Remarks on Bertrand Russell’s Theory of Knowledge,” *The Philosophy of Bertrand Russell*, Vol. 5 of *The Library of Living Philosophers*, editor Paul Arthur Schilpp (LaSalle, Illinois: Open Court, 1944), p. 289.
- e. Philip Van der Elst, *C. S. Lewis: A Short Introduction* (New York: Continuum, 1996), p. 24.

43. Strange Planets

- a. “... most every prediction by theorists about planetary formation has been wrong.” Scott Tremaine, as quoted by Richard A. Kerr, “Jupiters Like Our Own Await Planet Hunters,” *Science*, Vol. 295, 25 January 2002, p. 605.

- ◆ “To sum up, I think that all suggested accounts of the origin of the Solar System are subject to serious objections. The conclusion in the present state of the subject would be that the system cannot exist.” Harold Jeffreys, *The Earth: Its Origin, History, and Physical Constitution*, 6th edition (Cambridge, UK: Cambridge University Press, 1976), p. 387.

- ◆ “But if we had a reliable theory of the origin of planets, if we knew of some mechanism consistent with the laws of physics so that we understood how planets form, then clearly we could make use of it to estimate the probability that other stars have attendant planets. However, no such theory exists yet, despite the large number of hypotheses suggested.” R. A. Lyttleton, *Mysteries of the Solar System* (Oxford, England: Clarendon Press, 1968), p. 4.

- ◆ “A great array of observational facts must be explained by a satisfactory theory [on the evolution of the solar system], and the theory must be consistent with the principles of dynamics and modern physics. All of the hypotheses so far presented have failed, or remain unproved, when physical theory is properly applied.” Fred L. Whipple, *Earth, Moon, and Planets*, 3rd edition (Cambridge, Massachusetts: Harvard University Press, 1968), p. 243.

- ◆ “Attempts to find a plausible naturalistic explanation of the origin of the Solar System began about 350 years ago but have not yet been quantitatively successful, making this one of the oldest unsolved problems in modern science.” Stephen G. Brush, *A History of Modern Planetary Physics*, Vol. 3 (Cambridge, UK: Cambridge University Press, 1996), p. 91.

- b. “I wish it were not so, but I’m somewhat skeptical that we’re going to learn an awful lot about Earth by looking at other planetary bodies. The more that we look at the different planets, the more each one seems to be unique.” Michael Carr, as quoted by Richard A. Kerr, “The Solar System’s New Diversity,” *Science*, Vol. 265, 2 September 1994, p. 1360.

“The most striking outcome of planetary exploration is the diversity of the planets.” David J. Stevenson, as quoted by Richard A. Kerr, *Ibid.*

“Stevenson and others are puzzling out how subtle differences in starting conditions such as distance from the sun, along with chance events like giant impacts early in the solar system history, can send planets down vastly different evolutionary paths.” Kerr, *Ibid.*

“You put together the same basic materials and get startlingly different results. No two [planets] are alike; it’s like a zoo.” Alexander Dessler, as quoted by Richard A. Kerr, *Ibid.*, p. 1361.

- c. Uranus’ spin axis is “tilted” 97.77°. In other words, Uranus spins on its side and slightly backwards. Evolutionists have incorrectly speculated that Uranus must have been tipped over by a giant impact. However, such an impact would not have changed the orbital planes of Uranus’ larger moons, which are also “tipped over.”
- d. *The Astronomical Almanac for the Year 2003* (Washington, D.C.: U.S. Government Printing Office, 2003), p. F2.

- e. Ibid.
f. Ibid.

- ◆ The Moon's orbital plane is inclined 18.5° – 28.5° to Earth's equatorial plane. (The Moon's orbital plane precesses between those values over an 18.6-year cycle.) This is a considerable inclination when one recognizes that the Moon possesses 82.9% of the angular momentum of the Earth-Moon system. No other planet-satellite system comes close to this amount.

Theories that for centuries claimed to show how the Moon evolved can now be rejected because of this fact alone. A more recent theory claims that a Mars-size body collided with the early Earth and kicked up debris that formed the Moon. Ward and Canup acknowledge that

Recent models of this process predict that the orbit of the newly formed Moon should be in, or very near [less than 1°], the Earth's equatorial plane. William R. Ward and Robin M. Canup, "Origin of the Moon's Orbital Inclination from Resonant Disk Interactions," *Nature*, Vol. 403, 17 February 2000, p. 741.

Nevertheless, speculative ways to circumvent this problem continue to be suggested. Even if some theory could explain the Moon's high orbital inclination and angular momentum, other problems remain. [See "[Origin of the Moon](#)" on page 29.]

- g. "*There is no spot on Phoebe's surface that is absent of water absorption.*" Wesley C. Fraser and Michael E. Brown, "Phoebe: A Surface Dominated by Water," *The Astronomical Journal*, Vol. 156, July 2018, pp. 1–13
- h. Lyttleton, p. 16.
- ◆ Fred Hoyle, *The Cosmology of the Solar System* (Hillside, New Jersey: Enslow Publishers, 1979), pp. 11–12.
 - ◆ "*One of the detailed problems is then to explain how the Sun itself acquires nearly 99.9% of the mass of the solar system but only 2% of its angular momentum.*" Frank D. Stacey, *Physics of the Earth* (New York: John Wiley & Sons, 1969), p. 4.
 - ◆ Some have proposed transferring angular momentum from the Sun to the planets by "magnetic linking." McCrea states: *However, I scarcely think it has yet been established that the postulated processes would inevitably occur, or that if they did they would operate with the extreme efficiency needed in order to achieve the required distribution of angular momentum.* William Hunter McCrea, "Origin of the Solar System," *Symposium on the Origin of the Solar System* (Paris, France: Centre National de la Recherche Scientifique, 1972), p. 8.
- i. All those astronomers and planetary scientists said,
We, as planetary scientists and astronomers, do not agree with the IAU's definition of a planet, nor will we use it.
Jenny Hogan, "Pluto: The Backlash Begins," *Nature*, Vol. 442, 31 August 2006, pp. 965.

- ◆ A trans-Neptunian object (TNO) is any minor planet orbiting the Sun at a greater average distance than Neptune.
- ◆ The IAU said Pluto was not a planet, because of its small size (two-thirds the diameter of our moon) and the discovery, beginning in 1992, of thousands of smaller trans-Neptunian objects (TNOs). However, Pluto is the largest known TNO. A more likely reason for the IAU's decision was that Pluto contradicts in many ways evolutionary theories for how planets evolve. Pluto has been a thorn in the evolutionists' side.

Pluto has long been a misfit in the prevailing theories of the solar system's origin: it is thousands of times less massive than the four gas-giant outer planets, and its orbit is very different from the well-separated, nearly circular and co-planar orbits of the eight other major planets. Pluto's is eccentric: during one complete revolution, the planet's distance from the sun varies from 29.7 to 49.5 astronomical units [AU] Pluto also travels 8 AU above and 13 AU below the mean plane of the other planets' orbits. Renu Malhotra, "Migrating Planets," *Scientific American*, Vol 281, September 1999, p. 59.

A simple fix for the IAU would have been to consider Pluto as both a trans-Neptunian object and (for historical reasons) a planet. Also, an honest acknowledgement that all planets are unique would have clarified matters. The many newly discovered planets outside our solar system are completely different from those inside the solar system. Evolutionary processes do not explain them. [See "[Have Planets Been Discovered Outside the Solar System?](#)" on page 513.]

For more information on the battles among astronomers concerning Pluto's planetary status, see Laurence A. Marschall and Stephen P. Maran, *Pluto Confidential* (Dallas, Texas: Benbella Books, Inc., 2009). Thousands of professional astronomers will not abide by the IAU's stealthy vote and will continue to consider Pluto a planet.

44. Earth: The Water Planet

- a. "*Earth has substantially more water than scientists would expect to find at a mere 93 million miles from the sun.*" Ben Harder, "Water for the Rock: Did Earth's Oceans Come from the Heavens?" *Science News*, Vol. 161, 23 March 2002, p. 184.
- b. The water content of Comet Tempel 1 was 38% by mass. [See Endnote 5 on page 326.]
- c. "*Hence, if comets like Hale-Bopp brought in the Earth's water, they would have brought in a factor of 40,000 times more argon than is presently in the atmosphere.*" T. D. Swindle and D. A. Kring, "Implications of Noble Gas Budgets for the Origin of Water on Earth and Mars," *Eleventh Annual V. M. Goldschmidt Conference*, Abstract No. 3785 (Houston: Lunar and Planetary Institute, 20–24 May 2001). [To learn how comets probably gained argon, see Endnote 35 on page 328.]
- d. "*Oxygen, D/H and Os [osmium] isotopic ratios all ... rule out extant meteoritic material as sources of the Earth's water.*" Michael J. Drake and Kevin Righter, "Determining

the Composition of the Earth,” *Nature*, Vol. 416, 7 March 2002, p. 42.

D/H is the ratio of heavy hydrogen (also called *deuterium*, or D) to normal hydrogen (H). Drake and Righter give other reasons meteorites could not have provided much of Earth’s water.

- e. “If water came from millions of comets or small asteroids, the same steady rain would have bombarded Mercury, Venus, Earth, and Mars, so they would all have begun with the same water characteristics, he says. However, the waters of those four planets now have dissimilar profiles, Owen and other geochemists have found.” Ibid.

After reading pages 301–374, you will see that the water in comets, asteroids, and meteoroids—as well as some water detected elsewhere in the inner solar system—came primarily from the subterranean water chambers. During the flood, this subterranean water mixed with Earth’s surface water, giving our surface water different isotope characteristics from water in comets, asteroids, and meteoroids.

“The carrier’s [the tanker’s] elemental and isotopic characteristics would have to have been unlike those of any object that researchers have yet found in the solar system. ... it doesn’t seem geochemically plausible ...” Ibid., p. 186.

45. Molten Earth?

- a. “The textbook view that the earth spent its first half a billion years drenched in magma could be wrong.” John W. Valley, “A Cool Early Earth?” *Scientific American*, Vol. 294, October 2005, p. 59.
- b. “The kinetic energy ($\sim 5 \times 10^{38}$ ergs) released in the largest impacts (1.5×10^{27} g at 9 km/sec) would be several times greater than that required to melt the entire Earth.” George W. Wetherill, “Occurrence of Giant Impacts during the Growth of the Terrestrial Planets,” *Science*, Vol. 228, 17 May 1985, p. 879.
- c. If gold were found only near volcanoes, then one might claim that gold was brought up to Earth’s surface by volcanoes. However, gold is seldom found near volcanoes.

Suppose extremely hot water (932°F or 500°C) was once below Earth’s surface. Gold in high concentrations would go into solution. If the solution then escaped to Earth’s surface, most gold would precipitate as the water’s pressure and temperature dropped. If this happened, about 250 cubic miles of water must have burst forth to account for the gold found in just one gold mining region in Canada. [See Robert Kerrich, “Nature’s Gold Factory,” *Science*, Vol. 284, 25 June 1999, pp. 2101–2102.] If these ideal pressure-temperature conditions did not exist, even more water must come up faster to account for the Earth’s gold deposits. These are hardly the slow processes that evolutionists visualize. On pages 111–151 and 469–475, you will see how, why, and when vast amounts of hot water burst up through faults.

About 40% of all gold mined in the world is from the Witwatersrand Basin in South Africa. This gold, deposited

in compressional fractures within the basin, precipitated from water whose temperature exceeded 300°C. [See A. C. Barnicoat et al., “Hydrothermal Gold Mineralization in the Witwatersrand Basin,” *Nature*, Vol. 386, 24 April 1997, pp. 820–824.]

- ◆ Robert R. Loucks and John A. Mavrogenes, “Gold Solubility in Supercritical Hydrothermal Brines Measured in Synthetic Fluid Inclusions,” *Science*, Vol. 284, 25 June 1999, pp. 2159–2163.
- d. Valley, pp. 58–65.
- e. “Meteorites, he notes, contain 10 times as much xenon, relative to other noble gasses, than occurs in Earth’s atmosphere. In addition, the relative abundance of xenon isotopes found in meteorites doesn’t jibe with the pattern found on Earth. If meteorites did deliver most of the water to our planet, they also would have provided xenon, and our atmosphere would have to have a very different composition, Owen maintains.” Ron Cowen, “Found: Primordial Water,” *Science News*, Vol. 156, 30 October 1999, p. 285.

46. Evolving Planets?

- a. “Planet formation is a paradox: according to standard theory, dust grains orbiting newborn stars should spiral into those stars rather than accrete to form planets.” Philip Campbell, “Trap Holds Protoplanet Dust,” *Nature*, Vol. 498, 13 June 2013, p. 141.
- ◆ Very special conditions are required to capture and then merge orbiting bodies. They are discussed more fully starting on page 302.
- b. John F. Kerridge and James F. Vedder, “An Experimental Approach to Circumsolar Accretion,” *Symposium on the Origin of the Solar System* (Paris, France: Centre National de la Recherche Scientifique, 1972), pp. 282–283.
- ◆ “It turns out to be surprisingly difficult for planetesimals to accrete mass during even the most gentle collisions.” Erik Asphaug, “The Small Planets,” *Scientific American*, Vol. 282, May 2000, p. 54.
 - ◆ “But little is known about how microscopic dust particles can grow 14 orders of magnitude bigger to become a giant planet within the relatively short lifetime of the disk.” Zhaohuan Zhu, “Growing Planet Brought to Light,” *Nature*, Vol. 527, 19 November 2015, p. 310.
- c. Tim Folger, “This Battered Earth,” *Discover*, January 1994, p. 33.
- ◆ “‘We came to the conclusion,’ says Lissauer, ‘that if you accrete planets from a uniform disk of planetesimals, [the observed] prograde rotation just can’t be explained.’ The simulated bombardment leaves a growing planet spinning once a week at most, not once a day.” Richard A. Kerr, “Theoreticians Are Putting a New Spin on the Planets,” *Science*, Vol. 258, 23 October 1992, p. 548.
 - ◆ Luke Dones and Scott Tremaine, “Why Does the Earth Spin Forward?” *Science*, Vol. 259, 15 January 1993, pp. 350–354.

- ◆ Some believe that the inner planets (Mercury, Venus, Earth, and Mars) gained their spins through a few very large and improbable impacts. However, this appeal to large, improbable impacts will not work for the giant outer planets (Jupiter, Saturn, Uranus, and Neptune), which have the most spin energy. Such impacts on these gaseous planets would be even more improbable, because they move more slowly and are so far from the center of the solar system. Besides, impacts from large rocks would not account for the composition of the giant planets—primarily hydrogen and helium.
- d. *“Building Jupiter has long been a problem to theorists.”* George W. Wetherill, “How Special Is Jupiter?” *Nature*, Vol. 373, 9 February 1995, p. 470.
- ◆ *“Talk about a major embarrassment for planetary scientists. There, blazing away in the late evening sky, are Jupiter and Saturn—the gas giants that account for 93% of the solar system’s planetary mass—and no one has a satisfying explanation of how they were made.”* Richard A. Kerr, “A Quickie Birth for Jupiters and Saturns,” *Science*, Vol. 298, 29 November 2002, p. 1698.
- e. This idea has a further difficulty. If, as the solar system began to form, a large, rocky planet quickly formed near Jupiter’s orbit, why didn’t a rocky planet form in the adjacent asteroid belt where we see more than 200,000 rocky bodies (asteroids) today?
- f. B. Zuckerman et al., “Inhibition of Giant-Planet Formation by Rapid Gas Depletion around Young Stars,” *Nature*, Vol. 373, 9 February 1995, pp. 494–496.
- g. *“In the best simulations of the process [of evolving Uranus and Neptune], cores for Uranus and Neptune fail to form at their present positions in even 4.5-billion years, [what evolutionists believe is] the lifetime of the solar system. ‘Things just grow too slowly’ in the outermost solar system, says Weidenschilling. ‘We’ve tried to form Uranus and Neptune at their present locations and failed miserably.’”* Stuart Weidenschilling, as quoted by Richard A. Kerr, “Shaking Up a Nursery of Giant Planets,” *Science*, Vol. 286, 10 December 1999, p. 2054.
- ◆ Renu Malhotra, “Chaotic Planet Formation,” *Nature*, Vol. 402, 9 December 1999, pp. 599–600.
- ◆ This has also been observed for Jupiter’s rings. Jupiter has a few moons large enough to be hit frequently by meteoroids or comets, small enough to have little gravity so debris can escape the moon, and close enough to Jupiter that tidal effects can spread the moon’s debris into rings. [See Ron Cowen, “Mooning Over the Dust Rings of Jupiter,” *Science News*, Vol. 154, 12 September 1998, pp. 182–183. See also Gretchen Vogel, “Tiny Moon Source of Jupiter’s Ring,” *Science*, Vol. 281, 25 September 1998, p. 1951.]
- d. James O’Donoghue, et. al. “Observations of the Chemical and Thermal Response of ‘Ring Rain’ on Saturn’s Ionosphere,” *Icarus* (2018), doi: <https://doi.org/10.1016/j.icarus.2018.10.027>
- ◆ *“Yet nonstop erosion poses a difficult problem for the very existence of Saturn’s opaque rings—the expected bombardment rate would pulverize the entire system in only 10,000 years! Most of this material is merely redeposited elsewhere in the rings, but even if only a tiny fraction is truly lost (as ionized vapor, for example), it becomes a real trick to maintain the rings since the formation of the solar system [as imagined by evolutionists].”* Jeffrey N. Cuzzi, “Ringed Planets: Still Mysterious—II,” *Sky & Telescope*, Vol. 69, January 1985, p. 22.
- ◆ Jeffrey N. Cuzzi, “Saturn: Jewel of the Solar System,” *The Planetary Report*, July/August 1989, pp. 12–15.
- ◆ Also, water in Saturn’s rings is rapidly ionized and transported along magnetic lines to certain latitudes on Saturn. The Hubble Space Telescope has detected this water concentration in Saturn’s atmosphere. [See Richard A. Kerr, “Slow Leak Seen in Saturn’s Rings,” *Science*, Vol. 274, 29 November 1996, p. 1468.]
- ◆ Richard A. Simpson and Ellis D. Miner, “Uranus: Beneath That Bland Exterior,” *The Planetary Report*, July/August 1989, pp. 16–18.
- ◆ *“Saturn’s rings (as well as the recently discovered ring system around Uranus) are unstable, therefore recent formations.”* S. K. Vsekhsyvatsky, “Comets and the Cosmogony of the Solar System,” *Comets, Asteroids, Meteorites*, editor A. H. Delsemme (Toledo, Ohio: The University of Toledo, 1977), p. 473.
- ◆ See Endnote 159 on page 375.

47. Planetary Rings

- a. William K. Hartmann, *Moons and Planets*, 3rd edition (Belmont, California: Wadsworth Publishing Co., 1993), p. 143.
- b. Similar faulty logic claims that, because we see comets, asteroids, and meteoroids, the solar system must have evolved.
- c. *“Geysers on [Saturn’s moon] Enceladus replenish the E ring.”* Richard A. Kerr, “At Last, a Supportive Parent for Saturn’s Youngest Ring,” *Science*, Vol. 309, 9 September 2005, p. 1660.
- ◆ *“Saturn’s moons are bombarded by comets or micro-meteoroids. Those collisions knock off ice particles and send them into orbit around Saturn, forming rings.”* Ron Cowen, “Ring Shots,” *Science News*, Vol. 170, 21 October 2006, p. 263.

48. Origin of the Moon

- a. *“The whole subject of the origin of the moon must be regarded as highly speculative.”* Robert C. Haymes, *Introduction to Space Science* (New York: John Wiley & Sons, 1971), p. 209.
- ◆ On 10 November 1971, Dr. Harold Urey, a Nobel prize-winning chemist and lunar scientist, stated *“I do not know the origin of the moon, I’m not sure of my own or any other’s models, I’d lay odds against any of the models proposed being correct.”* Robert Treash, “Magnetic Remanence in Lunar Rocks,” *Pensee*, Vol. 2, May 1972, p. 22.
- ◆ *“In astronomical terms, therefore, the Moon must be classed as a well-known object, but astronomers still have to admit shamefacedly that they have little idea as to where it came from. This is particularly embarrassing, because the solution of the mystery was billed as one of the main goals of the US lunar*

- exploration programme.*” David W. Hughes, “The Open Question in Selenology,” *Nature*, Vol. 327, 28 May 1987, p. 291.
- b. Paul M. Steidl, *The Earth, the Stars, and the Bible* (Grand Rapids: Baker Book House, 1979), pp. 77–79.
- ◆ M. Mitchell Waldrop, “The Origin of the Moon,” *Science*, Vol. 216, 7 May 1982, pp. 606–607.
- ◆ “If the Moon had separated from the Earth, it would either have broken away completely or returned, but it could not have gone into orbit.” Stacey, p. 38.
- c. “... the $^{50}\text{Ti}/^{47}\text{Ti}$ ratio of the Moon is identical to that of the Earth within about four parts per million, which is only 1/150 of the isotopic range documented in meteorites.” Junjun Zhang et al., “The Proto-Earth as a Significant Source of Lunar Material,” *Nature Geoscience*, Vol. 5, April 2012, p. 251.
- d. “The giant impact has major problems. It doesn’t produce the moon as seen.” David J. Stevenson, as quoted by Daniel Clery, “Impact Theory Gets Whacked,” *Science*, Vol. 342, 11 October 2013, p. 184.
- ◆ “The moon rocks, however, showed [oxygen isotope] ratios markedly similar to those of rocks from Earth. ‘The moon and Earth are indistinguishable on the oxygen isotope plot,’ Melosh said. The isotopes of other elements told the same story.” Jay Melosh, as quoted by Daniel Clery, *Ibid.*
- e. “We conclude that an Earth system with multiple moons is the final result unless some particularly severe constraints on initial conditions in the disk are met.” Robin M. Canup and Larry W. Esposito, “Accretion of the Moon from an Impact-Generated Disk,” *Icarus*, Vol. 119, February 1996, p. 427.
- f. “... no reasonable means to rid the Earth/Moon system of this excess angular momentum has yet been proposed.” Shigeru Ida et al., “Lunar Accretion from an Impact-Generated Disk,” *Nature*, Vol. 389, 25 September 1997, p. 357.
- g. “A collision big and hot enough to yield the moon’s magma ocean would have melted at least part of Earth’s surface as well. But geologists could not find any evidence that the mantle had ever melted. If it had, they expected to find that iron-loving elements such as nickel, tungsten, and cobalt had been drawn from Earth’s upper layers into its iron core. Instead, the concentration of iron-loving elements, called siderophiles, remains relatively high in Earth’s mantle. And other elements that should have segregated in a liquid mantle were instead commingled.” Karen Wright, “Where Did the Moon Come From?” *Discover*, Vol. 24, February 2003, pp. 65–66.
- h. “This is a problem for the giant impact theory, says [Erik] Hauri. ‘It’s hard to imagine a scenario in which a giant impact melts, completely, the moon, and at the same time allows it to hold onto its water,’ he says. ‘That’s a really, really difficult knot to untie.’” Nell Greenfieldboyce, quoting Erik Hauri, “Glass Beads from Moon Hint of Watery Past,” www.npr.org/templates/story/story.php?storyId=92383117, 12 July 2008. [See Endnote 76 on page 331.]
- i. Jack J. Lissauer, “It’s Not Easy to Make the Moon,” *Nature*, Vol. 389, 25 September 1997, pp. 327–328.
- ▲
- ## 49. Evolution of the Solar System?
- a. “For decades, astronomers have speculated that debris left over from the formation of the solar system or newly formed from colliding asteroids is continuously falling toward the sun and vaporizing. The infrared signal, if it existed, would be so strong at the altitude of Mauna Kea [Hawaii], above the infrared-absorbing water vapor in the atmosphere, that the light-gathering power of the large infrared telescopes would be overkill. ... In the case of the infrared search for the dust ring, [Donald N. B.] Hall [Director of the University of Hawaii’s Institute for Astronomy] was able to report within days that ‘the data were really superb.’ They don’t tell an entirely welcome story, though. ‘Unfortunately, they don’t seem to show any dust rings at all.’” Charles Petit, “A Mountain Cliffhanger of an Eclipse,” *Science*, Vol. 253, 26 July 1991, pp. 386–387.
- ◆ “... interplanetary dust is not highly concentrated around the sun. In situ measurements made with impact detectors aboard the two Helios probes, which reached a heliocentric distance of 60 [solar radii], have also shown that the spatial IDP [interplanetary dust particle] density gradually levels off inside ~100 solar radii.
- “Our two-dimensional IR [infrared] observations have shown unambiguously that a prominent circumsolar dust ring did not exist at the time of the 11 July 1991 solar eclipse. Consistent with these results, a second recent IR eclipse experiment also found no evidence of surface brightness enhancements.” P. Lamy et al., “No Evidence of a Circumsolar Dust Ring from Infrared Observations of the 1991 Solar Eclipse,” *Science*, Vol. 257, 4 September 1992, p. 1379.
- b. L. F. Miranda et al., “Water-Maser Emission from a Planetary Nebula with a Magnetic Torus,” *Nature*, Vol. 414, 15 November 2001, pp. 284–286.
- c. In the 1780s, “William Herschel gave planetary nebula their name, because he found that their appearance resembled the greenish disk of a planet.” Sun Kwok, *The Origin and Evolution of Planetary Nebula* (Cambridge University Press, 2007), p. 1.
- ▲
- ## 50. Faint Young Sun
- a. Gregory S. Jenkins et al., “Precambrian Climate: The Effects of Land Area and Earth’s Rotation Rate,” *Journal of Geophysical Research*, Vol. 98, 20 May 1993, pp. 8785–8791.
- This paper acknowledges that if Earth rotated almost twice as fast as it does today, this problem would be lessened—but not solved. Still required are a flooded Earth and an atmosphere with 30–300 times more carbon dioxide than today.
- b. Let’s assume an old Earth and at least a fifth of the atmospheric carbon dioxide needed to prevent a runaway ice age had been present throughout Earth’s first 2,750,000,000 years. That carbon dioxide would have combined with weathered rocks to produce large amounts of the mineral siderite (FeCO_3). Siderite is missing from ancient soils, showing that the concentrations of carbon dioxide needed to prevent a frozen Earth were never present. [See Rob Rye et al., “Atmospheric Carbon Dioxide Concentrations before

- 2.2 Billion Years Ago,” *Nature*, Vol. 378, 7 December 1995, pp. 603–605.]
- ♦ “There is no direct evidence to show that carbon dioxide levels were ever a thousand times higher.” Gregory Jenkins, as quoted by Tim Folger, “The Fast Young Earth,” *Discover*, November 1993, p. 32.
 - c. William R. Kuhn, “Avoiding a Permanent Ice Age,” *Nature*, Vol. 359, 17 September 1992, p. 196.
 - d. “The methane greenhouse effect is limited, however, because organic haze starts to form [chemically] at CH_4/CO_2 ratios higher than ~ 0.1 , and this creates an anti-greenhouse effect that cools the surface if the haze becomes too thick.” James F. Kasting, “Faint Young Sun Redux,” *Nature*, Vol. 464, 1 April 2010, p. 688.
 - e. In 1972, Carl Sagan and George H. Mullen first proposed that the early Earth had lots of heat-trapping methane and ammonia. They had no evidence for early methane and ammonia; they simply were looking for something that might have warmed the Earth, so there would have been no runaway deep freeze and life could have evolved. At the time of Sagan’s death (1996), he was still looking.
 - f. “Despite all of these proposed warming mechanisms, there are still reasons to think that the faint young Sun problem is not yet solved. Ice albedo feedback has been neglected in all of these one-dimensional climate calculations.” Kasting, p. 688.
 - g. For a frank admission of these and other “special pleadings,” see Carl Sagan and Christopher Chyba, “The Early Faint Sun Paradox: Organic Shielding of Ultraviolet-Labile Greenhouse Gases,” *Science*, Vol. 276, 23 May 1997, pp. 1217–1221.
- b. “A final point to be made is that the second law of thermodynamics and the principle of increase in entropy have great philosophical implications. The question that arises is how did the universe get into the state of reduced entropy in the first place, since all natural processes known to us tend to increase entropy? ... The author has found that the second law tends to increase his conviction that there is a Creator who has the answer for the future destiny of man and the universe.” Gordon J. Van Wylen, *Thermodynamics* (New York: John Wiley & Sons, 1959), p. 169.
 - ♦ “The time asymmetry of the Universe is expressed by the second law of thermodynamics, that entropy increases with time as order is transformed into disorder. The mystery is not that an ordered state should become disordered but that the early Universe apparently was in a highly ordered state.” Don N. Page, “Inflation Does Not Explain Time Asymmetry,” *Nature*, Vol. 304, 7 July 1983, p. 39.
- “There is no mechanism known as yet that would allow the Universe to begin in an arbitrary state and then evolve to its present highly-ordered state.” *Ibid.*, p. 40.
- ♦ “The real puzzle is why there is an arrow of time at all; that is, why the Universe is not simply a thermodynamic equilibrium at all times (except during the inevitable local fluctuations). The theory of nonequilibrium systems [such as those described by Ilya Prigogine] may tell us how such systems behave, given that there are some; but it does not explain how they come to be so common in the first place (and all oriented in the same temporal direction). This is ‘time’s greatest mystery’, and for all its merits, the theory of nonequilibrium systems does not touch it. What would touch it would be a cosmological demonstration that the Universe was bound to be in a low-entropy state after the Big Bang.” Huw Price, “Past and Future,” *Nature*, Vol. 348, 22 November 1990, p. 356.

51. Mountains of Venus

- a. Richard A. Kerr, “A New Portrait of Venus: Thick-Skinned and Decrepit,” *Science*, Vol. 263, 11 February 1994, pp. 759–760.

52. Space, Time, and Matter

- a. Nathan R. Wood, *The Secret of the Universe*, 10th edition (Grand Rapids: Eerdmans Publishing Co., 1936).

53. A Beginning

- a. “So long as the universe had a beginning, we could suppose it had a creator.” Stephen W. Hawking, *A Brief History of Time* (New York: Bantam Books, 1988), pp. 140–141.

55. Second Law of Thermodynamics

- a. “The more orthodox scientific view is that the entropy of the universe must forever increase to its final maximum value. It has not yet reached this: we should not be thinking about it if it had. It is still increasing rapidly, and so must have had a beginning; there must have been what we may describe as a ‘creation’ at a time not infinitely remote.” Jeans, p. 181.

56. Big Bang?

- a. “Observations only recently made possible by improvements in astronomical instrumentation have put theoretical models of the Universe [the big bang theory] under intense pressure. The standard ideas of the 1980s about the shape and history of the Universe have now been abandoned—and cosmologists are now taking seriously the possibility that the Universe is pervaded by some sort of vacuum energy, whose origin is not at all understood.” Peter Coles, “The End of the Old Model Universe,” *Nature*, Vol. 393, 25 June 1998, p. 741.
 - ♦ “Three years ago, observations of distant, exploding stars blew to smithereens some of astronomers’ most cherished ideas about the universe [the big bang theory]. To piece together an updated theory, they’re now thinking dark thoughts about what sort of mystery force may be contorting the cosmos.
- “According to the standard view of cosmology, the once infinitesimal universe has ballooned in volume ever since its fiery birth in the Big Bang, but the mutual gravitational tug of all the matter in the cosmos has gradually slowed that expansion.
- “In 1998, however, scientists reported that a group of distant supernovas were dimmer, and therefore farther from Earth, than the standard theory indicated. It was as if, in the

- billion or so years it took for the light from these exploded stars to arrive at Earth, the space between the stars and our planet had stretched out more than expected. That would mean that cosmic expansion has somehow sped up, not slowed down. Recent evidence has only firmed up that bizarre result.” Ron Cowen, “A Dark Force in the Universe,” *Science News*, Vol. 159, 7 April 2001, p. 218.
- ◆ “Not only don’t we see the universe slowing down; we see it speeding up.” Adam Riess, as quoted by James Glanz, “Astronomers See a Cosmic Antigravity Force at Work,” *Science*, Vol. 279, 27 February 1998, p. 1298.
 - ◆ “In one of the great results of twentieth century science, NSF-funded astronomers have shown both that the universe does not contain enough matter in the universe to slow the expansion, and that the rate of expansion actually increases with distance. Why? Nobody knows yet.” National Science Foundation Advertisement, “Astronomy: Fifty Years of Astronomical Excellence,” *Discover*, September 2000, p. 7.
 - ◆ “The expansion of the universe was long believed to be slowing down because of the mutual gravitational attraction of all the matter in the universe. We now know that the expansion is accelerating and that whatever caused the acceleration (dubbed “dark energy”) cannot be Standard Model physics.” Gordon Kane, “The Dawn of Physics Beyond the Standard Model,” *Scientific American*, Vol. 288, June 2003, p. 73.
 - ◆ “Astronomy, rather cosmology, is in trouble. It is, for the most part, beside itself. It has departed from the scientific method and its principles, and drifted into the bizarre; it has raised imaginative invention to an art form; and has shown a ready willingness to surrender or ignore fundamental laws, such as the second law of thermodynamics and the maximum speed of light, all for the apparent rationale of saving the status quo. Perhaps no ‘science’ is receiving more self-criticism, chest-beating, and self-doubt; none other seems so lost and misdirected; trapped in debilitating dogma.” Roy C. Martin Jr., *Astronomy on Trial: A Devastating and Complete Repudiation of the Big Bang Fiasco* (New York: University Press of America, 1999), p. xv.
- b. Redshifts can be caused by other phenomena. [See Jayant V. Narlikar, “Noncosmological Redshifts,” *Space Science Reviews*, Vol. 50, August 1989, pp. 523–614.] However, large redshifts are probably the result of the Doppler effect.
 - c. “... energy in recognizable forms (kinetic, potential, and internal) in an expanding, spatially unbounded, homogeneous universe is not conserved.” Edward R. Harrison, “Mining Energy in an Expanding Universe,” *The Astrophysical Journal*, Vol. 446, 10 June 1955, p. 66.
 - d. “The evidence is accumulating that redshift is a shaky measuring rod.” Margaret Burbidge (former director of the Royal Greenwich Observatory and past president of the American Association for the Advancement of Science), as quoted by Govert Schilling, “Radical Theory Takes a Test,” *Science*, Vol. 291, 26 January 2001, p. 579.
 - e. Halton M. Arp, *Quasars, Redshifts, and Controversies* (Berkeley, California: Interstellar Media, 1987).
 - f. “It clearly took a while after that primordial explosion for clouds of gas to congeal into a form dense enough for stars and quasars to ignite, and the Sky Survey is already prompting astronomers to question some of the assumptions about how that process unfolded [i.e., the big bang theory].” Michael D. Lemonick, “Star Seeker,” *Discover*, November 2001, p. 44.
 - g. William G. Tifft, “Properties of the Redshift,” *The Astrophysical Journal*, Vol. 382, 1 December 1991, pp. 396–415.
 - h. “The big bang made no quantitative prediction that the ‘background’ radiation would have a temperature of 3 degrees Kelvin (in fact its initial prediction [by George Gamow in 1946] was 30 degrees Kelvin); whereas Eddington in 1926 had already calculated that the ‘temperature of space’ produced by the radiation of starlight would be found to be 3 degrees Kelvin.” Tom Van Flandern, “Did the Universe Have a Beginning?” *Meta Research Bulletin*, Vol. 3, 15 September 1994, p. 33.
 “Despite the widespread acceptance of the big bang theory as a working model for interpreting new findings, not a single important prediction of the theory has yet been confirmed, and substantial evidence has accumulated against it.” *Ibid.*, p. 25.
 - ◆ “History also shows that some BB [big bang] cosmologists’ ‘predictions’ of MBR [microwave background radiation] temperature have been ‘adjusted’ after-the-fact to agree with observed temperatures.” William C. Mitchell, “Big Bang Theory Under Fire,” *Physics Essays*, Vol. 10, June 1997, pp. 370–379.
 - ◆ “What’s more, the big bang theory can boast of no quantitative predictions that have subsequently been validated by observation.” Eric J. Lerner et al., “Bucking the Big Bang,” *New Scientist*, Vol. 182, 22 May 2004, p. 20. [This blistering article critiquing the big bang theory was originally signed by 33 scientists from 10 countries. Later 374 other scientists, engineers, and researchers endorsed the article. See www.cosmologystatement.org.]
 - i. “In each of the five patches of sky surveyed by the team, the distant galaxies bunch together instead of being distributed randomly in space. ‘The work is ongoing, but what we’re able to say now is that galaxies we are seeing at great distances are as strongly clustered in the early universe as they are today,’ says Steidel, who is at the California Institute of Technology in Pasadena.” Ron Cowen, “Light from the Early Universe,” *Science News*, Vol. 153, 7 February 1998, p. 92.
 - ◆ “One of the great challenges for modern cosmology is to determine how the initial power spectrum evolved into the spectrum observed today. ... the universe is much clumpier on those scales [600–900 million light-years] than current theories can explain.” Stephen D. Landy, “Mapping the Universe,” *Scientific American*, Vol. 280, June 1999, p. 44.
 - ◆ “There shouldn’t be galaxies out there at all, and even if there are galaxies, they shouldn’t be grouped together the way they are.” James Trefil, *The Dark Side of the Universe* (New York: Charles Scribner’s Sons, 1988), p. 3.
 - ◆ Geoffrey R. Burbidge, “Was There Really a Big Bang?” *Nature*, Vol. 233, 3 September 1971, pp. 36–40.

- ◆ Ben Patrusky, “Why Is the Cosmos ‘Lumpy?’” *Science* 81, June 1981, p. 96.
- ◆ Stephen A. Gregory and Laird A. Thompson, “Superclusters and Voids in the Distribution of Galaxies,” *Scientific American*, Vol. 246, March 1982, pp. 106–114.
- ◆ *“In fact, studies we have done show that the distribution of matter is fractal, just like a tree or a cloud.”* [Patterns that repeat on all scales are called *fractal*.] Francesco Sylos Labini, as quoted by Marcus Chown, “Fractured Universe,” *New Scientist*, Vol. 163, 21 August 1999, p. 23.
“If this dissenting view is correct [that the universe is fractal] and the Universe doesn’t become smoothed out on the very largest scales, the consequences for cosmology are profound. ‘We’re lost,’ says [Professor of Astrophysics, Peter] Coles. ‘The foundations of the big bang models would crumble away. We’d be left with no explanation for the big bang, or galaxy formation, or the distribution of galaxies in the Universe.’” Ibid.
- j. Margaret J. Geller and John P. Huchra, “Mapping the Universe,” *Science*, Vol. 246, 17 November 1989, pp. 897–903. [See also M. Mitchell Waldrop, “Astronomers Go Up Against the Great Wall,” *Science*, Vol. 246, 17 November 1989, p. 885.]
- ◆ John Travis, “Cosmic Structures Fill Southern Sky,” *Science*, Vol. 263, 25 March 1994, p. 1684.
- ◆ Will Saunders et al., “The Density Field of the Local Universe,” *Nature*, Vol. 349, 3 January 1991, pp. 32–38.
- ◆ *“But this uniformity [in the cosmic microwave background radiation, CMB] is difficult to reconcile with the obvious clumping of matter into galaxies, clusters of galaxies and even larger features extending across vast regions of the universe, such as ‘walls’ and ‘bubbles.’”* Ivars Peterson, “Seeding the Universe,” *Science News*, Vol. 137, 24 March 1990, p. 184.
- ◆ As described below, one of the largest structures in the universe, “The Great Wall,” was discovered in 1989. It consists of tens of thousands of galaxies lined up in a wall-like structure, stretching across half a billion light-years of space. It is so large that none of its edges have been found. An even larger structure, the Sloan Great Wall, was discovered in 2003 and is the largest structure known in the universe.
“The theorists know of no way such a monster [the Great Wall] could have condensed in the time available since the Big Bang, especially considering that the 2.7 K background radiation reveals a universe that was very homogeneous in the beginning.” M. Mitchell Waldrop, “The Large-Scale Structure of the Universe Gets Larger—Maybe,” *Science*, Vol. 238, 13 November 1987, p. 894.
“The map’s most eye-catching feature is the Sloan Great Wall of galaxies, a clustering of galaxies that stretches 1.37 billion light-years across the sky and is the largest cosmic structure ever found. Astronomers worried that such a humongous structure, 80 percent bigger than the famous Great Wall of galaxies first discerned in a sky survey 2 decades ago, might violate the accepted model of galaxy evolution.” Ron Cowen, “Cosmic Survey,” *Science News*, Vol. 164, 1 November 2003, p. 276.
- ◆ James Glanz, “Precocious Structures Found,” *Science*, Vol. 272, 14 June 1996, p. 1590.
- ◆ For many years, big bang theorists searched in vain with increasingly precise instruments for temperature concentrations in the nearly uniform CMB. Without concentrations, matter could never gravitationally contract around those concentrations to form galaxies and galaxy clusters. Finally, in 1992, with great fanfare, an announcement was made in the popular media that slight concentrations were discovered. Major shortcomings were not mentioned:
 - ❖ The concentrations were only one part in 100,000—not much more than the errors in the instruments. Such slight concentrations could not be expected to initiate much clustering. As Margaret Geller stated, *“Gravity can’t, over the age of the universe, amplify these irregularities enough [to form huge clusters of galaxies].”* Travis, p. 1684.
 - ❖ *“[The] data are notoriously noisy, and the purported effect looks remarkably like an instrumental glitch: it appears only in one small area of the sky and on an angular scale close to the limit of the satellite’s resolution.”* George Musser, “Skewing the Cosmic Bell Curve,” *Scientific American*, Vol. 281, September 1999, p. 28.
 - ❖ Slight errors or omissions in the many data processing steps could easily account for the faint signal.
 - ❖ Reported variations in the CMB spanned areas of the sky that were 100 or 1,000 times too broad to produce galaxies.
 - ❖ *“... mysterious discrepancies have arisen between [the inflationary big bang] theory and observations ... It looks like inflation is getting into a major jam.”* Glen D. Starkman and Dominik J. Schwarz, “Is the Universe Out of Tune?” *Scientific American*, Vol. 293, August 2005, pp. 49, 55.
The slight temperature variations (0.00003°C) detected have a strong statistical connection with the solar system. [Ibid., pp. 52–55.] They probably have nothing to do with a big bang.
- k. *“And no element abundance prediction of the big bang was successful without some ad hoc parameterization to ‘adjust’ predictions that otherwise would have been judged as failures.”* Van Flandern, p. 33.
 - ◆ *“It is commonly supposed that the so-called primordial abundances of D, ³He, and ⁴He and ⁷Li provide strong evidence for Big Bang cosmology. But a particular value for the baryon-to-photon ratio needs to be assumed ad hoc to obtain the required abundances.”* H. C. Arp et al., “The Extragalactic Universe: An Alternative View,” *Nature*, Vol. 346, 30 August 1990, p. 811.
 - ◆ *“The study of historical data shows that over the years predictions of the ratio of helium to hydrogen in a BB [big bang] universe have been repeatedly adjusted to agree with the latest available estimates of that ratio as observed in the real universe. The estimated ratio is dependent on a ratio of baryons to photons (the baryon number) that has also been arbitrarily adjusted to agree with the currently established helium to hydrogen ratio. These appear to have not been*

predictions, but merely adjustments of theory ('retrodictions') to accommodate current data." William C. Mitchell, p. 375.

- l. Steidl, pp. 207–208.
- ◆ D. W. Sciama, *Modern Cosmology* (London: Cambridge University Press, 1971), pp. 149–155.
 - m. *"Examining the faint light from an elderly Milky Way star, astronomers have detected a far greater abundance [a thousand times too much] of beryllium atoms than the standard Big Bang model predicts."* Ron Cowen, "Starlight Casts Doubt on Big Bang Details," *Science News*, Vol. 140, 7 September 1991, p. 151.
 - ◆ Gerard Gilmore et al., "First Detection of Beryllium in a Very Metal Poor Star: A Test of the Standard Big Bang Model," *The Astrophysical Journal*, Vol. 378, 1 September 1991, pp. 17–21.
 - ◆ Ron Cowen, "Cosmic Chemistry: Closing the Gap in the Origin of the Elements," *Science News*, Vol. 150, 2 November 1996, pp. 286–287.
 - n. *"One might expect Population III stars [stars with only hydrogen and helium and no heavier elements] to have the same sort of distribution of masses as stars forming today, in which case some should be small enough (smaller than 0.8 the mass of the Sun) still to be burning their nuclear fuel. The problem is that, despite extensive searches, nobody has ever found a zero-metallicity star."* Bernard Carr, "Where Is Population III?" *Nature*, Vol. 326, 30 April 1987, p. 829.
 - ◆ *"Are there any stars older than Population II [i.e., Population III stars]? There should be, if our ideas about the early history of the universe [i.e., the big bang theory] are correct. ... There is no statistically significant evidence for Population III objects [stars]."* Leif J. Robinson, "Where Is Population III?" *Sky and Telescope*, July 1982, p. 20.
 - ◆ *"Astronomers have never seen a pure Population III star, despite years of combing our Milky Way galaxy."* Robert Irion, "The Quest for Population III," *Science*, Vol. 295, 4 January 2002, p. 66.
- Supposedly, Population II stars, stars having slight amounts of some heavy elements, evolved after Population III stars. Predicted characteristics of Population II stars have never been observed.
- Spectral studies of ancient [Population II] stars in the Milky Way haven't turned up anything so distinctive [as the chemical elements that should be present], [Timothy] Beers notes, but the search continues.* Ibid., p. 67.
- ◆ A few stars might be Population III stars that became polluted with elements heavier than hydrogen and helium that fell into the star as dust. Tests are conducted to see if the right mix of these heavy elements that are in dust are present, such as titanium and iron. So far *"observations have yet to turn up any [Population III star]."* [See Christopher Crockett, "Milky Way May Harbor Primeval Stars," *Science News*, Vol. 188, 14 November, 2015, p. 12.]
 - o. *"Our result shows that this discrepancy is a universal problem concerning both the Milky Way and extra-galactic systems."* A. Mucciarelli et al., "The Cosmological Lithium Problem Outside the Galaxy," *Monthly Notices of the Royal Astronomical Society*, Vol. 444, 21 October 2014, p. 1812.
 - ◆ *"... stars in M54 have just as little lithium as stars in the Milky Way, suggesting that the lithium problem is universal."* Christopher Crockett, "Mystery of the Missing Lithium Extends Beyond the Milky Way," *Science News*, Vol. 186, 18 October 2014, p. 15.
 - p. Andrew Grant, "Lab Tests Mystery of Lithium Levels," *Science News*, Vol. 186, 9 August 2014, p.6.
 - q. *"It is a fundamental rule of modern physics [namely, the big bang theory] that for every type of particle in nature there is a corresponding 'antiparticle'."* Steven Weinberg, *The First Three Minutes* (New York: Bantam Books, Inc., 1977), p. 76.
 - ◆ *"If the universe began in the big bang as a huge burst of energy, it should have evolved into equal parts matter and antimatter. But instead the stars and nebulae are made of protons, neutrons and electrons and not their antiparticles (their antimatter equivalents)."* Kane, pp. 73–74.
 - ◆ *"But to balance the cosmic energy books—and to avoid violating the most fundamental laws of physics—matter and antimatter should have been created [in a big bang] in exactly equal amounts. And then they should have promptly wiped each other out. Yet here we are."* Tim Folger, "Antimatter," *Discover*, August 2004, p. 68.
 - ◆ *"As far as physicists know, matter and antimatter should have been created in equal amounts in the early Universe and so blasted each other into oblivion. But that didn't happen, and the origin of this fundamental imbalance remains one of the biggest mysteries in physics."* Elizabeth Gibney, "The Antimatter Race," *Nature*, Vol. 548, 3 August 2017, p. 20.
 - r. *"Within our galaxy, we can be confident that there are no stars of antimatter; otherwise, the pervasive interstellar medium would instigate annihilation and ensuing gamma-ray emission at a rate far in excess of that observed. ... One difficulty with the idea of antigalaxies lies in maintaining their separation from galaxies. Empty space may now separate them, but in the early universe, these regions must have been in relatively close contact. Annihilation seems difficult to avoid, particularly because we now know that many regions of intergalactic space are occupied by a tenuous gas. Interaction with the gas would make annihilation inevitable in antimatter regions, with the consequent emission of observable gamma radiation."* Joseph Silk, *The Big Bang* (San Francisco: W. H. Freeman and Co., 1980), p. 115.
 - ◆ *"Also, as far as we know, there is no appreciable amount of antimatter in the universe."* Weinberg, p. 88.
 - ◆ *"Antimatter continues to intrigue physicists because of its apparent absence in the observable Universe. Current theory requires that matter and antimatter appear in equal quantities after the Big Bang, but the Standard Model of particle physics offers no quantitative explanation for the apparent disappearance*

- of half the Universe.*” M. Ahmadi et al., “An Improved Limit on the Charge of Antihydrogen from Stochastic Acceleration,” *Nature*, Vol. 529, 21 January 2016, p. 373.
- s. “*Galaxy rotation and how it got started is one of the great mysteries of astrophysics. In a Big Bang universe, linear motions are easy to explain: They result from the bang. But what started the rotary motions?*” William R. Corliss, *Stars, Galaxies, Cosmos: A Catalog of Astronomical Anomalies* (Glen Arm, Maryland: The Sourcebook Project, 1987), p. 177.
- ◆ The big bang theory says that before the “bang,” all matter in the universe was concentrated at an infinitesimal point. Therefore, with the “primordial egg” having essentially a zero radius, matter would have had an infinitesimal amount of angular momentum. The law of conservation of angular momentum states that in an isolated system that has no external torques, which the universe would be (according to the theory), the angular momentum would not change. Therefore, according to the big bang theory, the universe today should have no net angular momentum. But it does!
- t. Alan Dressler, “The Large-Scale Streaming of Galaxies,” *Scientific American*, Vol. 257, September 1987, pp. 46–54.
- u. The “missing mass” problem is of historical interest only. It was first explained by R. H. Dicke, “Gravitation and the Universe: The Jayne Lectures for 1969,” *American Philosophical Society of Philadelphia*, 1970, p. 62. (It is sometimes called *the flatness problem*.) However, after the shocking discovery in 1998 that distant galaxies were accelerating (not decelerating) away from us, the missing mass problem was replaced by the “dark energy” problem. No longer was it necessary to find the missing mass that kept the universe from flying apart, because the best measurements showed that the universe was flying apart. The problem then became: (1) what force could overcome gravity and make the universe fly apart, and (2) since the universe was flying apart, how could mass be concentrated enough in the early universe to form stars and galaxies. To solve these problems, billions of dollars have been spent on experiments and observations. No solutions have been found, but theoretical speculations abound.
- Candidates for “missing mass” included neutrinos, black holes, dead stars, low-mass stars, various subatomic particles, and objects dreamed up by cosmologists simply to solve this problem. Each candidate had many scientific problems. Prior to 1998, this “missing mass” was sometimes called “dark matter.” Today, the term “dark matter” refers to a completely different problem with the big bang theory.
- v. “*Of all the many mysteries of modern astronomy, none is more vexing than the nature of dark matter. Most astronomers believe that large quantities of some unidentified material pervade the universe. ... Yet this dark matter has eluded every effort by astronomers and physicists to bring it out of the shadows. A handful of us suspect that it might not really exist, and others are beginning to consider this possibility seriously.*” Mordehai Milgrom, “Does Dark Matter Really Exist?” *Scientific American*, Vol. 287, August 2002, p. 43.
- ◆ One study of two adjacent galaxies showed that they had relatively little dark matter. [See Ron Cowen, “Ringing In a New Estimate for Dark Matter,” *Science News*, Vol. 136, 5 August 1989, p. 84.] Another study found no dark matter within 150 million light-years of Earth. [See Eric J. Lerner, “COBE Confounds the Cosmologists,” *Aerospace America*, March 1990, pp. 40–41.] A third study found no dark matter in a large elliptical galaxy, M105. [See “Dark Matter Isn’t Everywhere,” *Astronomy*, September 1993, pp. 19–20.] A fourth study found no dark matter in the main body of our galaxy. [See Alexander Hellemans, “Galactic Disk Contains No Dark Matter,” *Science*, Vol. 278, 14 November 1997, p. 1230.] A fifth study, after cataloging positions and distances of 100 million galaxies, concluded that the needed mass does not exist. [See Ron Cowen, “Whole-Sky Catalog,” *Science News*, Vol. 155, 6 February 1999, pp. 92–93.] A sixth study, the most sensitive ever conducted on Earth, found no dark matter. [See Charles Seife, “Once Again, Dark Matter Eludes a Supersensitive Trap,” *Science*, Vol. 304, 14 May 2004, p. 950.]
 - ◆ See “**93. Galaxy Clusters**” Endnote c on page 106.
 - ◆ “*... dark matter has not been detected in the laboratory, and there is no convincing theoretical explanation of dark energy.*” Carlton Baugh, “Universal Building Blocks,” *Nature*, Vol. 421, 20 February 2003, p. 792.
 - ◆ “*No one knows what dark matter is, but they know what it is not. It’s not part of the ‘standard model’ of physics that weaves together everything that is known about ordinary matter and its interactions.*” Jenny Hogan, “Welcome to the Dark Side,” *Nature*, Vol. 448, 19 July 2007, p. 241.
 - ◆ “*We should have seen hundreds or thousands of [dark matter] events and we simply don’t see any.*” Richard Gaitskell, as quoted by Adrian Cho, “New Experiment Torpedoes Lightweight Dark Matter,” *Science*, Vol. 342, 1 November 2013, p. 542.]
- w. James Peebles, as quoted by Steve Nadis, “Out of Sight, Out of MOND,” *Astronomy*, Vol. 29, August 2001, p. 31.
- ◆ “*We know little about that sea. The terms we use to describe its components, ‘dark matter’ and ‘dark energy,’ serve mainly as expressions of our ignorance.*” David B. Cline, “The Search for Dark Matter,” *Scientific American*, Vol. 288, March 2003, p. 52.
- x. One might also ask where the “cosmic egg” came from if there had been a big bang. Of course, the question is unanswerable. Pushing any origin explanation back far enough raises similar questions—all scientifically untestable. Thus, the question of **ultimate** origins is not a purely scientific matter. What science can do is test possible explanations once the starting assumptions are given. For example, if a tiny “cosmic egg” (having all the mass in the universe) existed, it should not explode or suddenly inflate, based on present understanding. Claiming that some strange, new phenomenon caused an explosion (or inflation) is philosophical speculation. While such speculation may or may not be correct, it is not science. [See “**How Can the Study of Creation Be Scientific?**” on page 438.]

- y. “Big Bang Gone Quiet,” *Nature*, Vol. 372, 24 November 1994, p. 304.
- ◆ Michael J. Pierce et al., “The Hubble Constant and Virgo Cluster Distance from Observations of Cepheid Variables,” *Nature*, Vol. 371, 29 September 1994, pp. 385–389.
 - ◆ Wendy L. Freedman et al., “Distance to the Virgo Cluster Galaxy M100 from Hubble Space Telescope Observations of Cepheids,” *Nature*, Vol. 371, 27 October 1994, pp. 757–762.
 - ◆ N. R. Tanvir et al., “Determination of the Hubble Constant from Observations of Cepheid Variables in the Galaxy M96,” *Nature*, Vol. 377, 7 September 1995, pp. 27–31.
 - ◆ Robert C. Kennicutt Jr., “An Old Galaxy in a Young Universe,” *Nature*, Vol. 381, 13 June 1996, pp. 555–556.
 - ◆ James Dunlop, “A 3.5-Gyr-Old Galaxy at Redshift 1.55,” *Nature*, Vol. 381, 13 June 1996, pp. 581–584.
 - ◆ “It’s clear to most people that you can’t be older than your mother. Astronomers understand this, too, which is why they’re so uncomfortable these days. The oldest stars in globular clusters seem to date back 15 billion years. The universe appears to be only 9 billion to 12 billion years old. At least one of those conclusions is wrong.” William J. Cook, “How Old Is the Universe?” *U.S. News & World Report*, 18–25 August 1997, p. 34.
 - z. “I have little hesitation in saying that a sickly pall now hangs over the big-bang theory. When a pattern of facts becomes set against a theory, experience shows that the theory rarely recovers.” Fred Hoyle, “The Big Bang Under Attack,” *Science Digest*, May 1984, p. 84.

57. Heavy Elements

- a. “Given that the cluster apparently comprises few galaxies, yet contains a large amount of iron, a new type of astronomical object is implied by our results. A revision of theoretical models of the metal [heavy element] enrichment process in galaxy clusters may therefore be required,” M. Hattori et al., “A Dark Cluster of Galaxies at Redshift $z=1$,” *Nature*, Vol. 388, 10 July 1997, p. 146.
- b. Lennox L. Cowie and Antoinette Songaila, “Heavy-Element Enrichment in Low-Density Regions of the Intergalactic Medium,” *Nature*, Vol. 394, 2 July 1998, pp. 44–46.
- c. “In both cases, the scatter of the observed values [of heavy hydrogen] is quite large and seems to reach a factor of 10. Although it is already surprising to see such variations within ~1000 pc from the sun, this looks unbelievable within only 30 pc from the sun.” [1 pc (or parsec) = 3.258 light-years] A. Vidal-Madjar, “Interstellar Helium and Deuterium,” *Diffuse Matter in Galaxies*, editors J. Audouze et al. (Boston: D. Reidel Publishing Co., 1983), pp. 77–78.

58. Interstellar Gas

- a. “The process by which an interstellar cloud is concentrated until it is held together gravitationally to become a protostar

is not known. In quantitative work, it has simply been assumed that the number of atoms per cm^3 has somehow increased about a thousand-fold over that in a dense nebula. The two principal factors inhibiting the formation of a protostar are that the gas has a tendency to disperse before the density becomes high enough for self-gravitation to be effective, and that any initial angular momentum would cause excessively rapid rotation as the material contracts. Some mechanism must therefore be provided for gathering the material into a sufficiently small volume that self-gravitation may become effective, and the angular momentum must in some way be removed.” Eva Novotny, *Introduction to Stellar Atmospheres and Interiors* (New York: Oxford University Press, 1973), pp. 279–280.

- b. Martin Harwit, *Astrophysical Concepts* (New York: John Wiley & Sons, 1973), p. 394.
- ◆ “... there is no reasonable astronomical scenario in which mineral grains can condense.” Fred Hoyle and Chandra Wickramasinghe, “Where Microbes Boldly Went,” *New Scientist*, Vol. 91, 13 August 1981, p. 413.
- c. “Contemporary opinion on star formation holds that objects called protostars are formed as condensations from the interstellar gas. This condensation process is very difficult theoretically, and no essential theoretical understanding can be claimed; in fact, some theoretical evidence argues strongly against the possibility of star formation. However, we know that the stars exist, and we must do our best to account for them.” John C. Brandt, *The Physics and Astronomy of the Sun and Stars* (New York: McGraw-Hill, 1966), p. 111.

59. Hertzsprung-Russell Diagram

- a. Li Chengyuan, et al., “The Exclusion of a Significant Range of Ages in a Massive Star Cluster,” *Nature*, Vol. 516, 18/25 December 2014, pp. 367–369.

60. Fast Binaries

- a. A. R. King and M. G. Watson, “The Shortest Period Binary Star?” *Nature*, Vol. 323, 4 September 1986, p. 105.
- ◆ Dietrick E. Thomsen, “A Dizzying Orbit for a Binary Star,” *Science News*, Vol. 130, 11 October 1986, p. 231.
- ◆ “Ultrafast Binary Star,” *Sky & Telescope*, February 1987, p. 154.
- b. Jonathan Eberhart, “Now You See It, Now You Don’t,” *Science News*, Vol. 135, 7 January 1989, p. 13.
- ◆ Patrick Moore, *The New Atlas of the Universe* (New York: Arch Cape Press, 1988), p. 176.

61. Star Births? Stellar Evolution?

- a. “The universe we see when we look out to its furthest horizons contains a hundred billion galaxies. Each of these galaxies contains another hundred billion stars. That’s 10^{22} stars all told. The silent embarrassment of modern astrophysics is that we do not know how even a single one of these stars managed

to form.” Martin Harwit, Book Reviews, *Science*, Vol. 231, 7 March 1986, pp. 1201–1202.

Harwit also lists three serious problems with all theories that claim stars formed—or are forming—by the gravitational collapse of interstellar gas clouds:

- i. *“The contracting gas clouds must radiate energy in order to continue their contraction; the potential energy that is liberated in this pre-stellar phase must be observable somehow, but we have yet to detect and identify it.”*
- ii. *“The angular momentum that resides in typical interstellar clouds is many orders of magnitude higher than the angular momentum we compute for the relatively slowly spinning young stars; where and how has the protostar shed that angular momentum during contraction?”*
- iii. *“Interstellar clouds are permeated by magnetic fields that we believe to be effectively frozen to the contracting gas; as the gas cloud collapses to form a star, the magnetic field lines should be compressed ever closer together, giving rise to enormous magnetic fields, long before the collapse is completed. These fields would resist further collapse, preventing the formation of the expected star; yet we observe no evidence of strong fields, and the stars do form, apparently unaware of our theoretical difficulties.”*

These problems are solved by the stretching explanation given in **“Why Is the Universe Expanding?”** on pages 439–453.

Actually, as of 2016, the best estimate of the number of galaxies that can be seen with the best telescopes is 1-3 trillion, not 100 billion that Harwit estimated. [See “Universe Much Richer in Galaxies,” *Nature*, Vol. 537, 22 September 2016, p. 453.]

- b. These explosions were misnamed “planetary nebulas,” because early astronomers thought these clouds were evolving planets around new stars. [See Bruce Balick and Adam Frank, “The Extraordinary Deaths of Ordinary Stars,” *Scientific American*, Vol. 291, July 2004, pp. 50–59.]
“Herschel ... speculated they might be planetary systems taking shape around young stars. The name stuck even though the opposite turned out to be true; this type of nebula consists of gas molted from dying stars. ... [Planetary nebulas] pose challenges to stellar evolution theory, the physics that describes the life story of stars.” Ibid., p. 52.
- c. *“... no one has unambiguously observed material falling onto an embryonic star, which should be happening if the star is truly still forming. And no one has caught a molecular cloud in the act of collapsing.”* Ivars Peterson, “The Winds of Starbirth,” *Science News*, Vol. 137, 30 June 1990, p. 409.
- ◆ *“Precisely how a section of an interstellar cloud collapses gravitationally into a star—a double or multiple star, or a solar system—is still a challenging theoretical problem. ... Astronomers have yet to find an interstellar cloud in the actual process of collapse.”* Fred L. Whipple, *The Mystery of Comets* (Washington, D.C.: Smithsonian Institution Press, 1985), pp. 211–212, 213.
- d. *“Yet astronomers have never witnessed [even] a high-mass star being born, and hotly debate how they form.”* Eric Hand,

“Mega-Array Reveals Birthplace of Giant Stars,” *Nature*, Vol. 492, 20/27 December 2012, p. 320.

This 1.4 billion dollar mega-array is being built *in hopes of* seeing a star being born. The birth of high-mass stars would be the easiest to see. So far, no births have been seen.

- ◆ *“The origin of stars represents one of the most fundamental unsolved problems of contemporary astrophysics.”* Charles J. Lada and Frank H. Shu, “The Formation of Sunlike Stars,” *Science*, Vol. 248, 4 May 1990, p. 564.
“Most disturbing, however, is the fact that, despite numerous efforts, we have yet to directly observe the process of stellar formation. We have not yet been able to unambiguously detect the collapse of a molecular cloud core or the infall of circumstellar material onto an embryonic star. Until such an observation is made, it would probably be prudent to regard our current hypotheses and theoretical scenarios with some degree of suspicion.” Ibid., p. 572.
- e. *“In fact, given our current understanding of how stars form and the properties of the galactic center, it’s [stellar evolution near the galactic center is] not allowed to happen.”* Andrea M. Gaze, as quoted by Ron Cowen, “Mystery in the Middle,” *Science News*, Vol. 163, 21 June 2003, p. 394.
- ◆ *“For example, no one can explain how the stars—which are 15 times heavier than our sun—got there [near the center of our galaxy]. According to most astronomical models, they are too big to have formed in the chaos of the galactic center but appear to be too young to have moved there from farther out.”* Robert Irion, “The Milky Way’s Dark, Starving Pit,” *Science*, Vol. 300, 30 May 2003, p. 1356.
“The bizarre question of the hour is what the young stars are doing there at all. Clouds of gas need a calm and cold setting to collapse into a ball dense enough to ignite nuclear fusion. Yet gravitational tidal forces—from the black hole and from stars in the galaxy’s nucleus—make the galactic center the antithesis of such a [stellar] nursery.” Ibid., p. 1357.
- ◆ *“Ironically, stars such as these have no business being so close to a black hole ... there is no plausible explanation of how and why the hot, young stars near the centre of the Milky Way and Andromeda got there.”* Fulvio Melia, “Odd Company,” *Nature*, Vol. 437, 20 October 2005, p. 1105.
- f. *“Little is known about the origins of globular clusters, which contain hundreds of thousands of stars in a volume only a few light years across. Radiation pressure and winds from luminous young stars should disperse the star-forming gas and disrupt the formation of the cluster.”* J. L. Turner et al., “An Extragalactic Supernebula,” *Nature*, Vol. 423, 5 June 2003, p. 621.
- g. *“Once a protostar reaches a threshold of about 20 solar masses, the pressure exerted by its radiation should overpower gravity and prevent it from growing any bigger. In addition to the radiation pressure, the winds that so massive a star generates disperse its natal cloud, further limiting its growth as well as interfering with the formation of nearby stars.”* Erick T. Young, “Cloudy with a Chance of Stars: Making

a Star Is No Easy Thing,” *Scientific American*, Vol. 302, February 2010, p. 40.

- ◆ “*Nascent stars above 20 solar masses are so luminous that they would be expected to disrupt their own formation, as well as that of nearby stars.*” Ibid., p. 37.
- h. Steidl, pp. 134–136.
- i. “*Nobody really understands how star formation proceeds. It’s really remarkable.*” Rogier A. Windhorst, as quoted by Corey S. Powell, “A Matter of Timing,” *Scientific American*, Vol. 267, October 1992, p. 30.
- ◆ “*If stars did not exist, it would be easy to prove that this is what we expect.*” Geoffrey R. Burbidge, as quoted by R. L. Sears and Robert R. Brownlee in *Stellar Structure*, editors Lawrence H. Aller and Dean McLaughlin (Chicago: University of Chicago Press, 1965), p. 577.
- ◆ “*We don’t understand how a single star forms, yet we want to understand how 10 billion stars form.*” Carlos Frenk, as quoted by Robert Irion, “Surveys Scour the Cosmic Deep,” *Science*, Vol. 303, 19 March 2004, p. 1750.

62. Galaxies

- a. “*There is much doubt, however, that galaxies evolve from one type to another at all.*” George Abell, *Exploration of the Universe*, 2nd edition (New York: Holt, Rinehart, and Winston, 1969), p. 629.
- ◆ “*Our conclusions, then, are that the sequence of the classification of galaxies is not an evolutionary sequence ...*” Paul W. Hodge, *The Physics and Astronomy of Galaxies and Cosmology* (New York: McGraw-Hill, 1966), p. 122.
- b. “*The problem of explaining the existence of galaxies has proved to be one of the thorniest in cosmology. By all rights, they just shouldn’t be there, yet there they sit. It’s hard to convey the depth of frustration that this simple fact induces among scientists.*” Trefil, p. 55.

Trefil explains the basis for this frustration in his fourth chapter, titled, “Five Reasons Why Galaxies Can’t Exist.”

- ◆ “*We cannot even show convincingly how galaxies, stars, planets, and life arose in the present universe.*” Michael Rowan-Robinson, “Review of the Accidental Universe,” *New Scientist*, Vol. 97, 20 January 1983, p. 186.
- ◆ “*A completely satisfactory theory of galaxy formation remains to be formulated.*” Silk, *The Big Bang*, p. 22.
- ◆ “*The theory of the formation of galaxies is one of the great outstanding problems of astrophysics, a problem that today seems far from solution.*” Weinberg, p. 68.
- ◆ Fifty cosmologists attended a conference on galaxy formation. After summarizing much observational data, two of the most respected authorities optimistically estimated the probability that any existing theory on galaxy formation is correct is about 1 out of 100. [See P. J. E. Peebles and Joseph Silk, “A Cosmic Book,” *Nature*, Vol. 335, 13 October 1988, pp. 601–606.]

c. Hodge, p. 123.

d. Harold S. Slusher, “Clues Regarding the Age of the Universe,” *ICR Impact*, No. 19, January 1975, pp. 2–3.

- ◆ Steidl, pp. 161–187.
- e. “*In its simplest form, the Big Bang scenario doesn’t look like a good way to make galaxies. It allows too little time for the force of gravity by itself to gather ordinary matter—neutrons, protons and electrons—into the patterns of galaxies seen today. Yet the theory survives for want of a better idea.*” Peterson, “Seeding the Universe,” p. 184.
- ◆ “*It [the Great Wall, composed of tens of thousands of galaxies] is far too large and too massive to have formed by the mutual gravitational attraction of its member galaxies.*” M. Mitchell Waldrop, “Astronomers Go Up Against the Great Wall,” *Science*, Vol. 246, 17 November 1989, p. 885. [See also Margaret J. Geller and John P. Huchra, “Mapping the Universe,” *Science*, Vol. 246, 17 November 1989, pp. 897–903.]

63. Radiometric Dating

- a. Larry Vardiman et al., *Radioisotopes and the Age of the Earth*, (El Cajon, California: Institute for Creation Research, 2005).
- ◆ Earlier researchers have argued that radioactive decay rates were much faster in the past. See:
 - ❖ “**Lead and Helium Diffusion**” on page 39.
 - ❖ Robert V. Gentry, “On the Invariance of the Decay Constant over Geological Time,” *Creation Research Society Quarterly*, Vol. 5, September 1968, pp. 83–84.
 - ❖ Robert V. Gentry, *Creation’s Tiny Mystery*, 2nd edition (Knoxville, Tennessee: Earth Sciences Associates, 1988), p. 282.
 - ❖ Paul A. Ramdohr, “New Observations on Radioactive Halos and Radioactive Fracturing,” *Oak Ridge National Laboratory Translation* (ORNL-tr-755), 26 August 1965, pp. 16–25.

64. Corals and Caves

- a. Ariel A. Roth, “Coral Reef Growth,” *Origins*, Vol. 6, No. 2, 1979, pp. 88–95.
- ◆ J. Th. Verstelle, “The Growth Rate at Various Depths of Coral Reefs in the Dutch East Indian Archipelago,” *Treubia*, Vol. 14, 1932, pp. 117–126.
- b. Ian T. Taylor, *In the Minds of Men* (Toronto: TFE Publishing, 1984), pp. 335–336.
- ◆ Larry S. Helmick et al., “Rapid Growth of Dripstone Observed,” *Creation Research Society Quarterly*, Vol. 14, June 1977, pp. 13–17.

65. Index Fossils

- a. “*Ever since William Smith [the founder of the index fossil technique] at the beginning of the 19th century, fossils have*

been and still are the best and most accurate method of dating and correlating the rocks in which they occur. ... Apart from very 'modern' examples, which are really archaeology, I can think of no cases of radioactive decay being used to date fossils." Derek V. Ager, "Fossil Frustrations," *New Scientist*, Vol. 100, 10 November 1983, p. 425.

b. "It cannot be denied that from a strictly philosophical standpoint geologists are here arguing in a circle. The succession of organisms has been determined by a study of their remains embedded in the rocks, and the relative ages of the rocks are determined by the remains of organisms that they contain." R. H. Rastall, "Geology," *Encyclopaedia Britannica*, Vol. 10, 1954, p. 168.

◆ "Are the authorities maintaining, on the one hand, that evolution is documented by geology and, on the other hand, that geology is documented by evolution? Isn't this a circular argument?" Larry Azar, "Biologists, Help!" *BioScience*, Vol. 28, November 1978, p. 714.

◆ "A circular argument arises: interpret the fossil record in the terms of a particular theory of evolution, inspect the interpretation, and note that it confirms the theory. Well, it would, wouldn't it?"

"... the fossils do not form the kind of pattern that would be predicted using a simple NeoDarwinian model." Thomas S. Kemp, "A Fresh Look at the Fossil Record," *New Scientist*, Vol. 108, 5 December 1985, p. 66.

◆ "The intelligent layman has long suspected circular reasoning in the use of rocks to date fossils and fossils to date rocks. The geologist has never bothered to think of a good reply, feeling that explanations are not worth the trouble as long as the work brings results. This is supposed to be hard-headed pragmatism." J. E. O'Rourke, "Pragmatism Versus Materialism in Stratigraphy," *American Journal of Science*, Vol. 276, January 1976, p. 47.

"The rocks do date the fossils, but the fossils date the rocks more accurately. Stratigraphy cannot avoid this kind of reasoning, if it insists on using only temporal concepts, because circularity is inherent in the derivation of time scales." *Ibid.*, p. 53.

Although O'Rourke attempts to justify the practices of stratigraphers, he recognizes the inherent problems associated with such circular reasoning.

◆ "But the danger of circularity is still present. For most biologists the strongest reason for accepting the evolutionary hypothesis is their acceptance of some theory that entails it. There is another difficulty. The temporal ordering of biological events beyond the local section may critically involve paleontological correlation, which necessarily presupposes the non-repeatability of organic events in geologic history. There are various justifications for this assumption but for almost all contemporary paleontologists it rests upon the acceptance of the evolutionary hypothesis." Kitts, p. 466.

◆ "It is a problem not easily solved by the classic methods of stratigraphical paleontology, as obviously we will land ourselves immediately in an impossible circular argument if we say, firstly that a particular lithology is synchronous on the evidence of its fossils, and secondly that the fossils are

synchronous on the evidence of the lithology." Derek V. Ager, *The Nature of the Stratigraphical Record*, 3rd edition (New York: John Wiley & Sons, 1993), p. 98.

◆ "The charge that the construction of the geologic scale involves circularity has a certain amount of validity." David M. Raup, "Geology and Creationism," *Field Museum of Natural History Bulletin*, Vol. 54, March 1983, p. 21.

◆ In a taped, transcribed, and approved 1979 interview with Dr. Donald Fisher, the state paleontologist for New York, Luther Sunderland asked Fisher how he dated certain fossils. **Answer:** "By the Cambrian rocks in which they were found." When Sunderland asked if this was not circular reasoning, Fisher replied, "Of course; how else are you going to do it?" "The Geologic Column: Its Basis and Who Constructed It," *Bible-Science News Letter*, December 1986, p. 6.

◆ "The prime difficulty with the use of presumed ancestral-descendant sequences to express phylogeny is that biostratigraphic data are often used in conjunction with morphology in the initial evaluation of relationships, which leads to obvious circularity." Bobb Schaeffer, Max K. Hecht, and Niles Eldredge, "Phylogeny and Paleontology," *Evolutionary Biology*, Vol. 6 (New York: Appleton-Century-Crofts, Inc., 1972), p. 39.

c. Peter Forey, "A Home from Home for Coelacanths," *Nature*, Vol. 395, 24 September 1998, pp. 319–320.

◆ Since the above discovery near Indonesia in 1998, most coelacanths are being caught off the coast of northern Tanzania, 500 miles north of what was thought to be their old habitats. [See Constance Holden, "Saving the Coelacanth," *Science*, Vol. 316, 8 June 2007, p. 1401.]

d. "Zoologists originally thought that the paired fins of coelacanths and the fossil lobe-fins functioned as true limbs, as props to lever the fish against the solid substrate of the bottom sand or against rocks." Keith S. Thomson, *Living Fossil: The Story of the Coelacanth* (New York: W. W. Norton & Co., Ltd., 1991), p. 160.

◆ "... much attention has been focused on their fins in the hope that they will tell more about how fins became limbs." Ommanney, p. 74.

◆ "For the coelacanth was a member of a very ancient class of fishes which was supposed to have disappeared some 70 million years ago. This great group of fishes, called crossopterygians, flourished during that decisive era in the history of the earth—when the fish, taking on legs and lungs, went forth to conquer the continents." Jacques Millot, "The Coelacanth," *Scientific American*, Vol. 193, December 1955, p. 34.

As late as 1955, Dr. Jacques Millot, who led many studies of freshly caught coelacanths, still believed coelacanths evolved legs.

Perhaps their stalked fins permit them to creep along the rocks like seals. *Ibid.*, p. 38.

This myth was buried only after Dr. Hans Fricke's team observed coelacanths in their natural habitat in 1987. Their bottom fins have nothing to do with legs or creeping.

Why did Millot ignore facts he knew best? The coelacanth, he thought, solved a big problem. In 1955, Millot wrote:

One of the great problems of evolution has been to find anatomical links between the fishes and their land-invading descendants ... For a long time evolutionists were troubled by this major gap between fishes and the amphibians. But the gap has now been bridged by studies of ancient fishes, and this is where the coelacanth comes in. Ibid., pp. 35–36.

Later (1987), after studying live coelacanths, the scientific world learned that Millot was wrong. The coelacanth did not bridge this gap. Therefore, the fish-to-amphibian problem is back.

- ◆ “He [J. L. B. Smith] was able to report [in the journal *Nature*] that, like the lungfishes, the fish had an air bladder or lung (on the basis of the taxidermist’s report of the discarded viscera), which was a median rather than paired structure.” Thomson, *Living Fossil*, p. 39. [It is now recognized that the discarded “bag” was not a lung, but an oil-filled swimming bladder.]
- e. “The brain of a 90-pound coelacanth weighs less than 50 grains [0.11 ounces]—that is, no more than one 15,000th of the body weight. No present-day vertebrate that we know of has so small a brain in relation to its size.” Millot, p. 39.
- f. “I confess I’m sorry we never saw a coelacanth walk on its fins.” Hans Fricke, “Coelacanths: The Fish That Time Forgot,” *National Geographic*, Vol. 173, June 1988, p. 838.
“... we never saw any of them walk, and it appears the fish is unable to do so.” Ibid., p. 837.
- g. “Few creatures have endured such an immense span of time with so little change as coelacanths. The cutaway drawing of a present-day specimen seems almost identical with the 140-million-year-old fossil found in a quarry in southern West Germany. ... Why have coelacanths remained virtually unchanged for eons ... 30 million generations?” Fricke, p. 833. [**Answer:** They were fossilized a few thousand years ago, during the flood.]
- ◆ “Throughout the hundreds of millions of years the coelacanths have kept the same form and structure. Here is one of the great mysteries of evolution—that of the unequal plasticity of living things.” Millot, p. 37.
- ◆ “The coelacanths have changed very little since their first known appearance in the Upper Devonian.” A. Smith Woodward, as quoted by Thomson, *Living Fossil*, p. 70.
- ◆ “What is even more remarkable is that in spite of drastic changes in the world environment, the coelacanths are still much the same organically as their ancestors. ... In the meantime, research is continuing ... and will try to penetrate the secret of the adaptability which has enabled them to live through many geological eras under widely differing conditions without modifying their constitution.” Millot, p. 39.
- ◆ “... the coelacanths have undergone little change in 300 million years ...” Ommanney, p. 74.

66. Humanlike Footprints

- a. Melvin A. Cook, “William J. Meister Discovery of Human Footprints with Trilobites in a Cambrian Formation of Western Utah,” *Why Not Creation?* editor Walter E. Lammerts (Phillipsburg, New Jersey: Presbyterian and Reformed Publishing Co., 1970), pp. 185–193.
- ◆ Michael A. Cremo and Richard L. Thompson, *Forbidden Archeology* (San Diego: Bhaktivedanta Institute, 1993), pp. 810–813.
- b. “Geology and Ethnology Disagree about Rock Prints,” *Science News Letter*, 10 December 1938, p. 372.
- c. Henry R. Schoolcraft and Thomas H. Benton, “Remarks on the Prints of Human Feet, Observed in the Secondary Limestone of the Mississippi Valley,” *The American Journal of Science and Arts*, Vol. 5, 1822, pp. 223–231.
- d. “Human-Like Tracks in Stone are Riddle to Scientists,” *Science News Letter*, 29 October 1938, pp. 278–279.
- e. “Make no mistake about it, says Tim [White, who is probably recognized as the leading authority on the Laetoli footprints]. ‘They are like modern human footprints. If one were left in the sand of a California beach today, and a four-year-old were asked what it was, he would instantly say that someone had walked there. He wouldn’t be able to tell it from a hundred other prints on the beach, nor would you. The external morphology is the same. There is a well-shaped modern heel with a strong arch and a good ball of the foot in front of it. The big toe is straight in line. It doesn’t stick out to the side like an ape toe, or like the big toe in so many drawings you see of Australopithecines in books.’” Johanson and Edey, p. 250.

The big toe of *Australopithecus africanus* splayed out to the side, as in apes. Obviously, the Laetoli footprints were not made by Australopithecines, as most evolutionists claim.

- ◆ “In sum, the 3.5-million-year-old footprint trails at Laetoli Site G resemble those of habitually unshod modern humans. None of their features suggest that the Laetoli hominids were less capable bipeds than we are. If the G footprints were not known to be so old, we would readily conclude that they were made by a member of our genus, *Homo*. ... we should shelve the loose assumption that the Laetoli footprints were made by Lucy’s kind, *Australopithecus afarensis*.” Russell H. Tuttle, “The Pitted Pattern of Laetoli Feet,” *Natural History*, Vol. 99, March 1990, p. 64.

67. Geologic Column

- a. “We are only kidding ourselves if we think that we have anything like a complete succession for any part of the stratigraphical column in any one place.” Ager, *Stratigraphical Record*, p. 48.
- b. John Woodmorappe, “The Essential Nonexistence of the Evolutionary-Uniformitarian Geologic Column: A Quantitative Assessment,” *Creation Research Society Quarterly*, Vol. 18, June 1981, pp. 46–71.

- c. The missing geologic periods are the Ordovician and Silurian. The Great Unconformity at the base of the sedimentary layers marks an even greater time gap—over a billion years.

68. Old DNA, Bacteria, Proteins, and Soft Tissue?

- a. This natural process is driven by the continual thermal vibrations of atoms in DNA. Just as marbles in a vibrating container always try to find lower positions, vibrating atoms tend to reorganize into arrangements with lower energies. Thus, DNA tends to form less-energetic compounds, such as water and carbon dioxide.
- b. Bryan Sykes, “The Past Comes Alive,” *Nature*, Vol. 352, 1 August 1991, pp. 381–382.
- ◆ “Many scientists still consider this idea [that DNA could last longer than 10,000 years] *far fetched, but Poinar points out that not long ago few people believed any ancient DNA could be sequenced.* ‘When we started, we were told that we were crazy,’ he says.” Kathryn Hoppe, “Brushing the Dust off Ancient DNA,” *Science News*, Vol. 142, 24 October 1992, p. 281.
- c. Ewen Callaway, “Hominin DNA Baffles Experts,” *Nature*, Vol. 504, 5 December 2013, pp. 16–17.
- d. Edward M. Golenberg et al., “Chloroplast DNA Sequence from a Miocene Magnolia Species,” *Nature*, Vol. 344, 12 April 1990, pp. 656–658.
- ◆ DNA disintegrates faster when it is in contact with water. In commenting on the remarkably old DNA in a supposedly 17-million-year-old magnolia leaf, Svante Pääbo remarked, “*The clay [in which the leaf was found] was wet, however, and one wonders how DNA could have survived the damaging influence of water for so long.*” Also see Svante Pääbo, “Ancient DNA,” *Scientific American*, Vol. 269, November 1993, p. 92. [Maybe those magnolia leaves are not 17-million years old.]
 - ◆ “*That DNA could survive for such a staggering length of time was totally unexpected—almost unbelievable.*” Jeremy Cherfas, “Ancient DNA: Still Busy after Death,” *Science*, Vol. 253, 20 September 1991, p. 1354.
- e. “*Fragments of 16S ribosomal RNA genes were detected by polymerase chain reaction amplification of DNA extracted from halite [salt, NaCl] samples ranging in age from 11 to 425 Myr (millions of years).*” Steven A. Fish et al., “Recovery of 16S Ribosomal RNA Gene Fragments from Ancient Halite,” *Nature*, Vol. 417, 23 May 2002, p. 432.
- f. Eske Willerslev et al., “Diverse Plant and Animal Genetic Records from Holocene and Pleistocene Sediments,” *Science*, Vol. 300, 2 May 2003, pp. 791–795.
- g. Hoppe, p. 281.
- ◆ Virginia Morell, “30-Million-Year-Old DNA Boosts an Emerging Field,” *Science*, Vol. 257, 25 September 1992, p. 1862.
- h. “*Under physiological conditions, it would be extremely rare to find preserved DNA that was tens of thousands of years old.*” Scott R. Woodward et al., “DNA Sequence from Cretaceous Period Bone Fragments,” *Science*, Vol. 266, 18 November 1994, p. 1229.

Some have charged that the DNA Woodward recovered from a large Cretaceous bone in Utah was contaminated with human or mammal DNA. Several of their arguments are based on evolutionary presuppositions. Woodward rebuts those claims in “Detecting Dinosaur DNA,” *Science*, Vol. 268, 26 May 1995, pp. 1191–1194.

- i. Hendrick N. Poinar et al., “DNA from an Extinct Plant,” *Nature*, Vol. 363, 24 June 1993, p. 677.
- ◆ Rob DeSalle et al., “DNA Sequences from a Fossil Termite in Oligo-Miocene Amber and Their Phylogenetic Implications,” *Science*, Vol. 257, 25 September 1992, pp. 1933–1936.
 - ◆ Raúl J. Cano et al., “Amplification and Sequencing of DNA from a 120–135-Million-Year-Old Weevil,” *Nature*, Vol. 363, 10 June 1993, pp. 536–538.
- j. Tomas Lindahl, a recognized expert on DNA and its rapid disintegration, claimed that contamination and poor measurement techniques account for the “old” DNA. He wrote, “*The apparent observation that fully hydrated plant DNA might be retained in high-molecular mass form for 20 million years is incompatible with the known properties of the chemical structure of DNA.*” [See Tomas Lindahl, “Instability and Decay of the Primary Structure of DNA,” *Nature*, Vol. 362, 22 April 1993, p. 714.] His claims of contamination are effectively rebutted in many of the papers listed above and by:
- ◆ George O. Poinar Jr., in “Recovery of Antediluvian DNA,” *Nature*, Vol. 365, 21 October 1993, p. 700. (The work of George Poinar and others was a major inspiration for the book and film, *Jurassic Park*.)
 - ◆ Edward M. Golenberg, “Antediluvian DNA Research,” *Nature*, Vol. 367, 24 February 1994, p. 692.
- The measurement procedures of Poinar and others were far better controlled than Lindahl realized. That is, modern DNA did not contaminate the fossil. However, Lindahl is probably correct in saying that DNA cannot last much longer than 10,000 years. All points of view are consistent when one concludes that these old ages are wrong.
- k. “*We know from chemical experiments that it [DNA] degrades and how fast it degrades. After 25 million years, there shouldn't be any DNA left at all.*” Rebecca L. Cann, as quoted by Morell, p. 1862.
- l. Raúl J. Cano and Monica K. Borucki, “Revival and Identification of Bacterial Spores in 25- to 40-Million-Year-Old Dominican Amber,” *Science*, Vol. 268, 19 May 1995, pp. 1060–1064.
- Many tests were performed to rule out contamination. [See also F. G. Priest, Andrew T. Beckenbach, and Raúl J. Cano, “Age of Bacteria from Amber,” *Science*, Vol. 270, 22 December 1995, pp. 2015–2017.]
- ◆ “*When you look at them they don't look any different from the modern ones, but these bacteria are ancient [supposedly 25–40-million years ancient] and they're alive!*” Joshua Fischman, “Have 25-Million-Year-Old Bacteria Returned to Life?” *Science*, Vol. 268, 19 May 1995, p. 977.

- m. *“There is also the question of how bacterial biopolymers can remain intact over millions of years in dormant bacteria; or, conversely, if bacteria are metabolically active enough to repair biopolymers, this raises the question of what energy source could last over such a long period.”* R. John Parkes, “A Case of Bacterial Immortality?” *Nature*, Vol. 407, 19 October 2000, pp. 844–845.
- ◆ Russell H. Vreeland et al., “Isolation of a 250 Million-Year-Old Halotolerant Bacterium from a Primary Salt Crystal,” *Nature*, Vol. 407, 19 October 2000, pp. 897–900.
 - ◆ Other tests have confirmed Vreeland’s discovery described above. [See Cindy L. Satterfield et al., “New Evidence for 250 Ma Age of Halotolerant Bacterium from a Permian Salt Crystal,” *Geology*, Vol. 33, April 2005, pp. 265–268.]
- n. See Endnote 104 on page 372.
- o. Richard Monastersky, “Protein Identified in Dinosaur Fossils,” *Science News*, Vol. 142, 3 October 1992, p. 213.
- ◆ Gerard Muyzer et al., “Preservation of the Bone Protein Osteocalcin in Dinosaurs,” *Geology*, Vol. 20, October 1992, pp. 871–874.
- p. *“I got goose bumps,’ recalls [Mary] Schweitzer. ‘It was exactly like looking at a slice of modern bone. But, of course, I couldn’t believe it. I said to the lab technician: The bones, after all, are 65 million years old. How could blood cells survive that long?’”* Virginia Morell, Dino DNA: The Hunt and the Hype,” *Science*, Vol. 261, 9 July 1993, p. 160.
- ◆ Blood vessels in bone appear to have been found in supposed 80-million-year-old dinosaur bones. [See “New Signs of Dinosaur Proteins,” *Science*, Vol. 350, 4 December 2015, p. 1137.]
 - ◆ *“Soft tissues are preserved within hindlimb elements of Tyrannosaurus rex (Museum of the Rockies specimen 1125). Removal of the mineral phase reveals transparent, flexible, hollow blood vessels ...”* Mary H. Schweitzer et al., “Soft-Tissue Vessels and Cellular Preservation in Tyrannosaurus Rex,” *Science*, Vol. 307, 25 March 2005, p. 1952.
 - ◆ *“I am quite aware that according to conventional wisdom and models of fossilization, these structures aren’t supposed to be there, but there they are,” said Schweitzer, lead author of the paper. ‘I was pretty shocked.’”* Evelyn Boswell, “Montana T. Rex Yields Next Big Discovery in Dinosaur Paleontology,” *Montana State University News Service*, 24 March 2005, p. 1.
 - ◆ Mary H. Schweitzer made these discoveries while completing her doctor’s degree under John “Jack” R. Horner, one of the world’s leading dinosaur researchers. Horner is the Curator of Paleontology at the Museum of the Rockies, and was a technical advisor for the film *Jurassic Park*.

When Schweitzer reported her discovery to Horner, he replied, *“Mary, the freaking creationists are just going to love you.”* Schweitzer replied, *“Jack, it’s your dinosaur.”* [See Jack Horner and James Gorman, *How to Build a Dinosaur* (New York: Penguin Group, 2009), pp. 80–81.

- ◆ See the interview with Mary Schweitzer on “60 Minutes” at www.youtube.com/watch?v=M9VbDFCndMI&feature=player_embedded
 - ◆ *“Here we report on an exceptionally complete specimen (LACM 128319) of the moderately derived genus Platecarpus that preserves soft tissues and anatomical details ...”* Johan Lindgren et al., “Convergent Evolution in Aquatic Tetrapods: Insights from an Exceptional Fossil Mosasaur,” *PloS ONE*, 5(8) e11998, 2010.
- q. Mary H. Schweitzer et al., “Heme Compounds in Dinosaur Trabecular Bone,” *Proceedings of the National Academy of Sciences*, Vol. 94, June 1997, pp. 6291–6296.
- r. *“This discovery also provides the oldest evidence of in situ preservation of complex organic remains in a terrestrial vertebrate.”* Robert R. Reisz et al., “Embryology of Early Jurassic Dinosaur from China with Evidence of Preserved Organic Remains,” *Nature*, Vol. 496, 11 April 2013, p. 210.
- s. *“We present multiple lines of evidence [from multiple independent institutions] that endogenous proteinaceous material is preserved in bone fragments and soft tissues from an 80-million-year-old Campanian hadrosaur, Brachylophosaurus canadensis. ... Transparent, flexible vessels were observed; some contained spherical microstructures, whereas others contained an amorphous red substance that is superficially similar to degraded blood products in vessels recovered from extant bone.”* Mary H. Schweitzer et al., “Biomolecular Characterization and Protein Sequence of the Campanian Hadrosaur B. Canadensis,” *Science*, Vol. 324, 1 May 2009, p. 626.
- t. *“What they found shocked them.”* Robert F. Service, “Signs of Ancient Proteins Seen Inside Dinosaur Bones,” *Science*, Vol. 348, 12 June 2015, p. 1184.
- u. *“University of Regina physicist Mauricio Barbi said the hadrosaur, a duck-billed dinosaur from the Late Cretaceous period (65–100 million years ago), was found close to a river bed near Grand Prairie, Alberta. ... ‘As we excavated the fossil, I thought that we were looking at a skin impression. Then I noticed a piece came off and I realized this is not ordinary—this is real skin.’ ... this is only the third three-dimensional dinosaur skin specimen ever found worldwide. ... But perhaps the greatest question Barbi is trying to answer at CLS is how the fossil remained intact for around 70-million years.”* Mark Ferguson, “Scientists Study Rare Dinosaur Skin Fossil at CLS,” Press Release, *Canadian Light Source*, 26 April 2013.
- v. *“There is still so much about ancient soft tissues that we do not understand. Why are these materials preserved when all our models say they should be degraded?”* Mary H. Schweitzer, “Blood from Stone,” *Scientific American*, Vol. 303, December 2010, p. 69.

Schweitzer and the *Scientific American* editors cannot account for the supposed 67-million-year age of the soft tissue and blood Schweitzer found. The answer is simple; its age is only 1/10,000th of that age. She and the editors don’t understand the flood and the origin of Earth’s radioactivity. [See pages 109–433.]

69. Human Artifacts

- a. J. Q. Adams, "Eve's Thimble," *American Antiquarian*, Vol. 5, October 1883, pp. 331–332.
- b. Wilbert H. Rusch, Sr., "Human Footprints in Rocks," *Creation Research Society Quarterly*, Vol. 7, March 1971, pp. 201–202.
- c. John Buchanan, "Discovery of an Iron Instrument Lately Found Imbedded in a Natural Seam of Coal in the Neighbourhood of Glasgow," *Proceedings of the Society of Antiquarians of Scotland*, Vol. 1, Part 2, Section IV, 1853.
- d. "A Necklace of a Prehistoric God," *Morrisonville Times* (Morrisonville, Illinois), 11 June 1891, p. 1.
- e. Robin Dennell, "The World's Oldest Spears," *Nature*, Vol. 385, 27 February 1997, pp. 767–768.
- ◆ Hartmut Thieme, "Lower Palaeolithic Hunting Spears from Germany," *Nature*, Vol. 385, 27 February 1997, pp. 807–810.
- f. "A Relic of a By-Gone Age," *Scientific American*, Vol. 7, 5 June 1852, p. 298.
- g. David Brewster, "Queries and Statements Concerning a Nail Found Imbedded in a Block of Sandstone Obtained from Kingoodie (MyInfield) Quarry, North Britain," reported to the British Association for the Advancement of Science, 1844.
- ◆ Rene Noorbergen, *Secrets of the Lost Races* (New York: The Bobbs-Merrill Co., Inc., 1977), p. 42.
- h. Ibid.
- i. J. R. Jochmans, "Strange Relics from the Depths of the Earth," *Bible-Science Newsletter*, January 1979, p. 1.
- j. Robert E. Gentet and Edward C. Lain, "The Nampa Image—An Ancient Artifact?" *Creation Research Society Quarterly*, Vol. 35, March 1999, pp. 203–210.
- ◆ G. Frederick Wright, *Man and the Glacial Period* (New York: D. Appleton and Co., 1897), pp. 297–300.
- ◆ G. Frederick Wright, "The Idaho Find," *American Antiquarian*, Vol. 2, 1889, pp. 379–381.
- ◆ G. Frederick Wright, "An Archaeological Discovery in Idaho," *Scribner's Magazine*, Vol. 7, 1890, pp. 235–238.
- k. Frank Calvert, "On the Probable Existence of Man during the Miocene Period," *Anthropological Institute Journal*, Vol. 3, 1873, pp. 127–129.
- ◆ J. B. Browne, "Singular Impression in Marble," *The American Journal of Science and Arts*, January 1831, p. 361.

70. Parallel Layers

- a. Geologists have known this for many years. [See Archibald Geikie, *Text-Book of Geology* (London: Macmillan Publishing Co., 1882), p. 602.]
- b. Henry M. Morris, *Scientific Creationism*, general edition (San Diego: Creation-Life Publishers, 1974), p. 113.
- c. "Potentially more important to geological thinking are those unconformities that signal large chunks of geological history are missing, even though the strata on either side of the

unconformity are perfectly parallel and show no evidence of erosion. Did millions of years fly by with no discernible effect? A possible though controversial inference is that our geological clocks and stratigraphic concepts need working on." William R. Corliss, *Unknown Earth* (Glen Arm, Maryland: The Sourcebook Project, 1980), p. 219.

- ◆ George McCready Price, *The New Geology*, 2nd edition (Mountain View, California: Pacific Press Publishing Assn., 1923), pp. 486, 500, 504, 506, 543, 620–627.
- ◆ George McCready Price, *Evolutionary Geology and the New Catastrophism* (Mountain View, California: Pacific Press Publishing Assn., 1926), pp. 90–104.

71. Helium

- a. "What Happened to the Earth's Helium?" *New Scientist*, Vol. 24, 3 December 1964, pp. 631–632.
- ◆ Melvin A. Cook, *Prehistory and Earth Models* (London: Max Parrish, 1966), pp. 10–14.
- ◆ Melvin A. Cook, "Where is the Earth's Radiogenic Helium?" *Nature*, Vol. 179, 26 January 1957, p. 213.
- ◆ Joseph W. Chamberlain, *Theory of Planetary Atmospheres* (New York: Academic Press, 1987), pp. 371–372.

72. Lead and Helium Diffusion

- a. "Taken together, these results strongly suggest that there has been little or no differential Pb loss which can be attributed to the higher temperatures existing at greater depths." Robert V. Gentry et al., "Differential Lead Retention in Zircons: Implications for Nuclear Waste Containment," *Science*, 16 April 1982, p. 296.
- ◆ Robert V. Gentry, "Letters," *Physics Today*, October 1982, pp. 13–14.
- b. Robert V. Gentry, "Letters," *Physics Today*, April 1983, p. 13.
- c. "In fact, considering the Precambrian age of the granite cores, our results show an almost phenomenal amount of He has been retained at higher temperatures, and the reason for this certainly needs further investigation ..." Robert V. Gentry et al., "Differential Helium Retention in Zircons," *Geophysical Research Letters*, Vol. 9, October 1982, p. 1130.
- ◆ Robert V. Gentry, Personal communication, 24 February 1984.
- ◆ D. Russell Humphreys et al., "Helium Diffusion Rates Support Accelerated Nuclear Decay," *Proceedings of the Fifth International Conference on Creationism* (Pittsburgh, Pennsylvania: Creation Science Fellowship, Inc., 2003), pp. 175–195.

73. Excess Fluid Pressure

- a. "It is certain that at the present time large areas of the Gulf Coast are underlain by zones containing water under pressure almost high enough to float the overlying rocks." Parke A. Dickey et al., "Abnormal Pressures in Deep Wells of South-western Louisiana," *Science*, Vol. 160, 10 May 1968, p. 614.

- b. "Some geologists find it difficult to understand how the great pressures found in some oil wells could be retained over millions of years. Creationists also use this currently puzzling situation as evidence that oil was formed less than 10,000 years ago." Stansfield, p. 82. [Stansfield had no alternative explanation.]
- ◆ Cook, *Prehistory and Earth Models*, p. 341.

74. Volcanic Debris

- a. Ariel A. Roth, "Some Questions about Geochronology," *Origins*, Vol. 13, No. 2, 1986, pp. 75–76.
- ◆ "It has been estimated that just four volcanoes spewing lava at the rate observed for *Paricutín* [a Mexican volcano that erupted in 1943] and continuing for five billion years could almost account for the volume of the continental crusts." Stansfield, p. 81.

75. River Sediments

- a. Stuart E. Nevins, "Evolution: The Ocean Says No!" *Symposium on Creation V* (Grand Rapids: Baker Book House, 1975), pp. 77–83.
- ◆ Roth, "Some Questions about Geochronology," pp. 69–71.

76. Continental Erosion

- a. Nevins, pp. 80–81.
- ◆ George C. Kennedy, "The Origin of Continents, Mountain Ranges, and Ocean Basins," *American Scientist*, Vol. 47, December 1959, pp. 491–504.
- ◆ Roth, "Some Questions about Geochronology," pp. 65–67.
- ◆ "North America is now being eroded at a rate that could level it in a mere 10 million years ..." Dott and Batten, p. 133.

77. Dissolved Metals

- a. "... most metals are markedly undersaturated with respect to their least soluble compounds, and the supply of metals during geological time has been more than sufficient to attain saturation." Peter G. Brewer, "Minor Elements in Sea Water," *Chemical Oceanography*, editors J. P. Riley and G. Skirrow, Vol. 1, 2nd edition (New York: Academic Press, 1975), p. 427.

78. Crater Creep

- a. Glenn R. Morton, Harold S. Slusher, and Richard E. Mandock, "The Age of Lunar Craters," *Creation Research Society Quarterly*, Vol. 20, September 1983, pp. 105–108.

The above study drew upon the work of Z. F. Danes, which was described as follows:

The history of a circular crater in a highly viscous medium is derived from the hydrodynamic equations of motion by Z. F. Danes. The variation in shape of the crater in the course of time is expressed as a function of a time constant, T, that involves viscosity and density of the medium, acceleration of gravity, and radius of the crater lip. Correspondence between theoretical

crater shapes and the observed ones is good. However the time constant, T, is surprisingly short if commonly accepted viscosity values are used. Geological Survey Professional Paper 550-A (Washington, D.C.: U.S. Government Printing Office, 1966), p. A 127.

Since Danes' work was published, rocks from the Moon have been returned to Earth and their viscosity has been measured. Their values fall between 10^{21} to 10^{22} poises. According to the Geological Survey paper just quoted, "If viscosities of lunar rocks were around 10^{21} to 10^{22} poises, the ages of large craters would have to be only 10^4 to 10^7 years."

79. Shallow Meteorites

- a. "In older geologic formations, no signs whatsoever of the presence of meteorites have been found ... If we consider, moreover, that since the onset of modern coal mining, some fifty to fifty-five billion tons of coal have been mined, all of which have passed through the hands of people with a professional familiarity with stones, it is certainly remarkable that ancient meteorite material has never been found or described up to now." Fritz Heide, *Meteorites* (Chicago: University of Chicago Press, 1964), p. 119.
- ◆ Peter A. Steveson, "Meteoritic Evidence for a Young Earth," *Creation Research Society Quarterly*, Vol. 12, June 1975, pp. 23–25.
- ◆ "... neither tektites nor other meteorites have been found in any of the ancient geologic formations ..." Ralph Stair, "Tektites and the Lost Planet," *The Scientific Monthly*, July 1956, p. 11.
- ◆ "No meteorites have ever been found in the geologic column." William Henry Twenhofel, *Principles of Sedimentation*, 2nd edition (New York: McGraw-Hill, 1950), p. 144.
- ◆ "... the astronomer Olbers had noticed: that there are no 'fossil' meteorites known, from any period older than the middle of the Quaternary. The quantity of coal mined during the last century amounted to many billions of tons, and with it about a thousand meteorites should have been dug out, if during the time the coal deposits were formed the meteorite frequency had been the same as it is today. Equally complete is the absence of meteorites in any other geologically old material that has been excavated in the course of technical operations." F. A. Paneth, "The Frequency of Meteorite Falls throughout the Ages," *Vistas in Astronomy*, Vol. 2, editor Arthur Beer (New York: Pergamon Press, 1956), p. 1681.
- ◆ "I have interviewed the late Dr. G. P. Merrill, of the U.S. National Museum, and Dr. G. T. Prior, of the British Natural History Museum, both well-known students of meteorites, and neither man knew of a single occurrence of a meteorite in sedimentary rocks." W. A. Tarr, "Meteorites in Sedimentary Rocks?" *Science*, Vol. 75, 1 January 1932, pp. 17–18.
- ◆ "No meteorites have been found in the geological column." Stansfield, p. 81.
- ◆ "In view of the connection of comets, meteors, and meteorites, the absence of meteorites in old deposits in the crust of the earth is very significant. It has been estimated that at least 500 meteorites should have been found in already worked coal

seams, whereas none has been identified in strata older than the Quaternary epoch (about 1 million years ago). This suggests a very recent origin of meteorites and, by inference, of comets.” N. T. Bobrovnikoff, “Comets,” *Astrophysics*, editor J. A. Hynek (New York: McGraw-Hill Book Co., 1951), p. 352.

- b. Hans Pettersson, “Cosmic Spherules and Meteoritic Dust,” *Scientific American*, Vol. 202, February 1960, pp. 123–129.
- c. “Examples of ancient rock slides have been identified from the geologic column in few instances.” William Henry Twenhofel, *Treatise on Sedimentation*, Vol. 1, 2nd edition (New York: Dover Publications, 1961), p. 102.

80. Moon Dust and Debris

- a. Before instruments were sent to the Moon, Isaac Asimov made some interesting, but false, predictions. After estimating the great depths of dust that should be on the Moon, Asimov dramatically ended his article by stating: *I get a picture, therefore, of the first spaceship, picking out a nice level place for landing purposes, coming in slowly downward tail-first and sinking majestically out of sight.* Isaac Asimov, “14 Million Tons of Dust Per Year,” *Science Digest*, January 1959, p. 36.
 - ◆ Lyttleton felt that dust from only the erosion of exposed Moon rocks by ultraviolet light and x-rays “could during the age of the moon be sufficient to form a layer over it several miles deep.” Raymond A. Lyttleton, *The Modern Universe* (New York: Harper & Brothers, 1956), p. 72.
 - ◆ Thomas Gold proposed that thick layers of dust accumulated in the lunar maria. [See Thomas Gold, “The Lunar Surface,” *Monthly Notices of the Royal Astronomical Society of London*, Vol. 115, 1955, pp. 585–604.]
 - ◆ Fears about the dust thickness lessened when instruments were sent to the Moon from 1964 to 1968. However, some concern remained, at least in Neil Armstrong’s mind, as he stepped on the Moon. [See transcript of conversations from the Moon, Chicago Tribune, 21 July 1969, Section 1, p. 1, and Paul D. Ackerman, *It’s a Young World After All* (Grand Rapids: Baker Book House, 1986), p. 19.]
- b. “Powdery particles resting on the moon’s surface could form a layer up to 1 millimeter thick every 1,000 years, according to a new analysis.” Meghan Rosen, “Moon Dust Gathers Surprisingly Fast,” *Science News*, Vol 185, 11 January 2014, p. 6.
 - ◆ Extrapolating this rate of 1 millimeter per 1,000 years would produce a dust layer almost 3-miles thick in 4.5-billion years!

81. Meteoritic Dust

- a. Steveson, pp. 23–25.

82. Rapid Cooling

- a. Harold S. Slusher and Thomas P. Gamwell, *Age of the Earth*, ICR Technical Monograph No. 7 (El Cajon, California: Institute for Creation Research, 1978).

- ◆ Leonard R. Ingersoll et al., *Heat Conduction: With Engineering, Geological and Other Applications*, revised edition (Madison, Wisconsin: University of Wisconsin Press, 1954), pp. 99–107.

84. Hot Moon

- a. “[The following is] a somewhat surprising outcome considering the size of the Moon and the assumption that most of its heat energy had been lost. ... These unexpectedly high lunar [heat flow] values seem to indicate the Moon’s interior is much hotter than most thermal models had anticipated. If the temperature gradient in the lower regolith is extrapolated to great depths, the lunar interior would appear to be at least partly molten—a condition contradicted by other evidence.” Nicholas M. Short, *Planetary Geology* (Englewood Cliffs, New Jersey: Prentice-Hall, 1975), p. 184.
 - ◆ In 2011, the Moon was discovered to have a small liquid core. [See Renee C. Weber et al., “Seismic Detection of the Lunar Core,” *Science*, Vol. 331, 21 January 2011, pp. 309–312.]
 - ◆ “Actual values of heat flow determined on the Moon at the Apollo 15 and 17 sites were two and three times higher than had been predicted.” Short, p.183.
- b. Dr. Kent Davey developed a 40,000 finite element model that considered a body of water ½ mile thick at temperature 150°F only ½ mile below the Moon’s surface. After 10,000 years that water’s temperature would only have decreased 53°F. Kent Davey, personal communication, 9 November 2015.
- c. The unexpectedly large heat flow may be a consequence of large impacts occurring on the lunar surface soon after the global flood. Because the flood was recent (only about 5300 years ago) excess heat should still be present. [See “[When Was the Flood, the Exodus, and Creation?](#)” on page 482, [Figure 175 on page 311](#) and “[Did the Preflood Earth Have a 30-Day Lunar Month?](#)” on page 586.]

85. Young Comets

- a. Ron Cowen, “Comets: Mudballs of the Solar System,” *Science News*, Vol. 141, 14 March 1992, pp. 170–171.
- b. Ray Jayawardhana, “Keeping Tabs on Cometary Breakups,” *Science*, Vol. 264, 13 May 1994, p. 907.
- c. See Endnote 29 on page 327.
- d. Raymond A. Lyttleton, “The Non-Existence of the Oort Cometary Shell,” *Astrophysics and Space Science*, Vol. 31, December 1974, p. 393.
 - ◆ If comet formation accompanies star formation, as evolutionists claim, then many comets should have been expelled from other stars. Some expelled comets should have passed through our solar system in recent years. No incoming comet has ever been observed with an interstellar (i.e. hyperbolic) orbit. [See Endnote 31 on page 328.]

86. Small Comets

- a. Louis A. Frank with Patrick Huyghe, *The Big Splash* (New York: Carol Publishing Group, 1990).

- ◆ Richard Monastersky, “Comet Controversy Caught on Film,” *Science News*, Vol. 133, 28 May 1988, p. 340.
- ◆ Timothy M. Beardsley, “Ice Storm,” *Scientific American*, Vol. 258, June 1988, p. 24.
- ◆ Jonathan Eberhart, “A Bunch of Little Comets—But Just a Little Bunch,” *Science News*, Vol. 132, 29 August 1987, p. 132.
- ◆ Richard A. Kerr, “In Search of Elusive Little Comets,” *Science*, Vol. 240, 10 June 1988, pp. 1403–1404.
- ◆ Richard A. Kerr, “Double Exposures Reveal Mini-Comets?” *Science*, Vol. 243, 13 January 1989, pp. 170–171.
- ◆ Richard Monastersky, “Small Comet Controversy Flares Again,” *Science News*, Vol. 137, 9 June 1990, p. 365.

87. Hot Planets

- a. H. H. Aumann and C. M. Gillespie Jr., “The Internal Powers and Effective Temperatures of Jupiter and Saturn,” *The Astrophysical Journal*, Vol. 157, July 1969, pp. L69–L72.
 - ◆ “*Jupiter radiates into space rather more than twice the energy it receives from space.*” G. H. A. Cole, *The Structure of Planets* (New York: Crane, Russak & Co., Inc., 1978), p. 114.
 - ◆ M. Mitchell Waldrop, “The Puzzle That Is Saturn,” *Science*, 18 September 1981, p. 1351.
 - ◆ Jonathan Eberhart, “Neptune’s Inner Warmth,” *Science News*, Vol. 112, 12 November 1977, p. 316.
- b. Ibid.
 - c. “The Mystery of Venus’ Internal Heat,” *New Scientist*, Vol. 88, 13 November 1980, p. 437.
 - d. To initiate nuclear fusion, a body must be at least ten times as massive as Jupiter. [See Andrew P. Ingersoll, “Jupiter and Saturn,” *Scientific American*, Vol. 245, December 1981, p. 92.]
 - e. Ingersoll and others once proposed that Saturn and Jupiter could generate internal heat if their helium gas liquefied or their liquid hydrogen solidified. Neither is possible, because each planet’s temperature greatly exceeds the critical temperatures of helium and hydrogen. (The critical temperature of a particular gas is that temperature above which no amount of pressure can squeeze it into a liquid or solid.) Even if the temperature were cold enough for gases to liquefy, what could initiate nucleation? When I mentioned this in a private conversation with Ingersoll in December 1981, he quickly acknowledged his error.
 - f. Paul M. Steidl, “The Solar System: An Assessment of Recent Evidence—Planets, Comets, and Asteroids,” *Design and Origins in Astronomy*, editor George Mulfinger Jr. (Norcross, Georgia: Creation Research Society Books, 1983), pp. 87, 91, 100.
 - ◆ Jupiter would have rapidly cooled to its present temperature, even if it had been an unreasonably hot 20,000 kelvins when it formed. Evolutionary models require too much time. [See Edwin V. Bishop and Wendell C. DeMarcus, “Thermal Histories of Jupiter Models,” *Icarus*, Vol. 12, May 1970, pp. 317–330.]

88. Solar Wind

- a. After showing photographic evidence for the presence of micrometeorites as small as 10^{-15} g that “*struck every square centimeter of the lunar surface,*” Stuart Ross Taylor stated:

It has been thought previously that radiation pressure would have swept less massive particles out of the inner solar system, but there is a finite flux below 10^{-14} g. Stuart Ross Taylor, *Lunar Science: A Post-Apollo View* (New York: Pergamon Press, Inc., 1975), p. 90.

Large lunar impacts are slowly, but continually, churning up and overturning the lunar surface. Therefore, for these micrometeorite impacts to blanket *the surface* so completely and not be erased, the impacts must have been recent. For more details, see [Figure 175 on page 311](#).

89. Poynting-Robertson Effect

- a. See “[Evolution of the Solar System?](#)” Endnote “a” on page 89. To understand the origin of zodiacal light, see page 342.
- b. Steidl, *The Earth, the Stars, and the Bible*, pp. 60–61.
- ◆ Harold S. Slusher and Stephen J. Robertson, *The Age of the Solar System: A Study of the Poynting-Robertson Effect and Extinction of Interplanetary Dust*, ICR Technical Monograph No. 6, revised edition (El Cajon, California: Institute for Creation Research, 1978).
- c. Stanley P. Wyatt Jr. and Fred L. Whipple, “The Poynting-Robertson Effect on Meteor Orbits,” *The Astrophysical Journal*, Vol. 3, January 1950, pp. 134–141.
- ◆ Ron Cowen, “Meteorites: To Stream or Not to Stream,” *Science News*, Vol. 142, 1 August 1992, p. 71.
- d. David A. Weintraub, “Comets in Collision,” *Nature*, Vol. 351, 6 June 1991, pp. 440–441.

90. Supernova Remnants

- a. “*An application of the present results to the [Milky Way] Galaxy yields one supernova per 26 (± 10 estimated error) years in very good agreement with the evidence from historical supernovae.*” G. A. Tammann, “On the Frequency of Supernovae as a Function of the Integral Properties of Intermediate and Late Type Spiral Galaxies,” *Astronomy and Astrophysics*, Vol. 8, October 1970, p. 458.
- ◆ A more recent technique that surveyed thousands of galaxies, including smaller galaxies, concluded that

... the time between [supernova] explosions is 100 years or more.” Michael S. Turner, “Yes, Things Really Are Going Faster,” *Science*, Vol. 299, 31 January 2003, p. 663.
- b. Keith Davies, “Distribution of Supernova Remnants in the Galaxy,” *Proceedings of the Third International Conference on Creationism* (Pittsburgh, Pennsylvania: Creation Science Fellowship, Inc., 1994), pp. 175–184.
- ◆ “*Where have all the remnants gone?*” Astronomy Survey Committee of the National Research Council, *Challenges to*

Astronomy and Astrophysics (Washington, D.C.: National Academy Press, 1983), p. 166.

91. Connected Galaxies

- a. Arp, *Quasars, Redshifts, and Controversies*.
- ◆ Fred Hoyle and Jayant V. Narlikar, "On the Nature of Mass," *Nature*, Vol. 233, 3 September 1971, pp. 41–44.
- ◆ William Kaufmann III, "The Most Feared Astronomer on Earth," *Science Digest*, July 1981, pp. 76–81, 117.
- ◆ Geoffrey Burbidge, "Redshift Rift," *Science* 81, December 1981, p. 18.

92. Unstable Galaxies

- a. Kevin Wagner, et al. "Direct Imaging Discovery of a Jovian Exoplanet within a Triple-Star System," *Science*, Vol. 353, 12 August 2016. p. 673.
- ◆ "...a number of other substellar objects have been observed in triple-star systems." Rebecca Oppenheimer, "Making Sense of the Exoplanet Zoo," *Science*, Vol. 353, 12 August 2016. p. 644.
- b. David Fleischer, "The Galaxy Maker," *Science Digest*, Vol. 89, October 1981, pp. 12, 116.

93. Galaxy Clusters

- a. "In 1933 the late Fritz Zwicky pointed out that the galaxies of the Coma cluster are moving too fast: there is not enough visible mass in the galaxies to bind the cluster together by gravity. Subsequent observations verified this 'missing' mass in other clusters." M. Mitchell Waldrop, "The Large-Scale Structure of the Universe," *Science*, Vol. 219, 4 March 1983, p. 1050.
- b. Faye Flam, "NASA PR: Hype or Public Education?" *Science*, Vol. 260, 4 June 1993, pp. 1417–1418.
- ◆ "It turns out that in almost every case the velocities of the individual galaxies are high enough to allow them to escape from the cluster. In effect, the clusters are 'boiling.' This statement is certainly true if we assume that the only gravitational force present is that exerted by visible matter, but it is true even if we assume that every galaxy in the cluster, like the Milky Way, is surrounded by a halo of dark matter that contains 90 percent of the mass of the galaxy." Trefil, p. 93.
- ◆ Gerardus D. Bouw, "Galaxy Clusters and the Mass Anomaly," *Creation Research Society Quarterly*, Vol. 14, September 1977, pp. 108–112.
- ◆ Steidl, *The Earth, the Stars, and the Bible*, pp. 179–185.
- ◆ Silk, *The Big Bang*, pp. 188–191.
- ◆ Arp, *Quasars, Redshifts, and Controversies*.
- ◆ Halton M. Arp, "NGC-1199," *Astronomy*, Vol. 6, September 1978, p. 15.
- ◆ Halton M. Arp, "Three New Cases of Galaxies with Large Discrepant Redshifts," *Astrophysical Journal*, 15 July 1980, pp. 469–474.

- c. A huge dust ring has been observed orbiting two galaxies. The measured orbital velocity of this ring allows the calculation of the mass of the two galaxies and any dark matter. There was little. Statistical analyses of 155 other small galactic groups also suggest that there is not enough dark matter to hold them together. [See Stephen E. Schneider, "Neutral Hydrogen in the M96 Group: The Galaxies and the Intergalactic Ring," *The Astrophysical Journal*, Vol. 343, 1 August 1989, pp. 94–106.]
- ◆ Nadia Drake, "Dark Matter, Where Art Thou?" *Science News*, Vol. 181, 19 May 2012, pp. 5–6.

94–102. Reports of Claimed Ark Sightings

- a. Violet M. Cummings, *Noah's Ark: Fact or Fable?* (San Diego: Creation-Science Research Center, 1972).
- ◆ Tim LaHaye and John D. Morris, *The Ark on Ararat* (San Diego: Creation-Life Publishers, 1976).
- ◆ John Warwick Montgomery, *The Quest for Noah's Ark* (Minneapolis: Bethany Fellowship, Inc., 1972).
- ◆ Rene Noorbergen, *The Ark File* (Mountain View, California: Pacific Press Publishing Assn., 1974).
- ◆ Violet M. Cummings, *Has Anybody Really Seen Noah's Ark?* (San Diego: Creation-Life Publishers, 1982).
- ◆ Dave Balsiger and Charles E. Sellier Jr., *In Search of Noah's Ark* (Los Angeles: Sun Classic Books, 1976).
- ◆ Charles E. Sellier and David W. Balsiger, *The Incredible Discovery of Noah's Ark* (New York: Dell Publishing, 1995).
- ◆ Richard C. Bright, *The Ark, A Reality?* (Guilford, New York: Ranger Associates, Inc., 1989).
- ◆ Bill Crouse, editor, *Ararat Report*, Vols. 1–32, 1986–present, published by CIS, 2050 N. Collins Blvd., Richardson, Texas 75080.
- ◆ Bill Crouse, *Project Ararat* (Richardson, Texas: CIS, 1985).
- ◆ Charles Berlitz, *The Lost Ship of Noah: In Search of the Ark at Ararat* (New York: G. P. Putnam's Sons, 1987).
- ◆ B. J. Corbin, *The Explorers of Ararat and the Search for Noah's Ark*, 2nd edition (Long Beach, California: Great Commission Illustrated Books, 1999).

94. Ancient Historians

- a. Marco Polo, *The Travels of Marco Polo* (New York: The Orion Press, 1958), p. 21.

98. George Hagopian

- a. Noorbergen, *Secrets of the Lost Races*, pp. 74–91.

99. Russian Expeditions

- a. Cummings, *Has Anybody Really Seen Noah's Ark?* pp. 61–108.
- b. Personal communication, Rex Geissler, 10 February 2000.

100. Ed Davis

- a. Robert Cornuke and David Halbrook, *Lost Mountains of Noah* (Nashville: Broadman & Holman Publishers, 2001).
- b. Don Shockey, *Agri-Dagh (Mount Ararat): The Painful Mountain* (Fresno, California: Pioneer Publishing Co., 1986), pp. 1–88.

129. Seashells on Mountaintops

- a. Alan Cutler, *The Seashell on the Mountaintop* (New York: Dutton, 2003).
- ◆ “Nothing is so high, nothing is so far from the sea that we cannot find [shells] of those creatures that only live in sea water.” Jan Van Gorp (1569), as quoted by Cutler, p. 59.
- ◆ John Woodward, *An Essay Towards a Natural History of the Earth* (London: 1695; reprint, New York: Arno Press, 1978), pp. 3–74.
- b. During the period 1508 to 1515, Leonardo da Vinci carefully studied the shells he found high in Italy’s Appennines Mountains. He raised valid arguments against all the hypotheses that others were proposing to explain seashells on mountaintops, but he offered no explanation of his own. [See Leonardo da Vinci, *The Notebooks of Leonardo Da Vinci*, Vol. 2, editor Jean Paul Richter (New York: Dover Publications, 1970), pp. 208–218.]
- c. For example, Voltaire wrote, “It always astonishes me that some refuse to allow that the earth produces these stones.” Cutler, p. 195.
- d. Twelve years before Thomas Jefferson became President of the United States, he was the U.S. Ambassador to France. In June of 1787, he traveled to the mountains near Tours, France to see dense deposits of clam shells 15,000 feet above sea level. Some, including Voltaire, had claimed that those shells were actually growing as “fruit of the earth.” After examining the deposit, Jefferson disagreed and wrote, The “*origin of shells in high places* [might be one of those questions] *beyond the investigation of human sagacity.*” [See H. A. Washington, *The Writings of Thomas Jefferson*, Vol. 9, (New York: Riker, Thorne & Co., 1854), p. 366.]

130. Flood Legends

- a. “It has long been known that legends of a great flood, in which almost all men perished, are widely diffused over the world ...” James George Frazer, *Folk-Lore in the Old Testament*, Vol. 1, (London: Macmillan Publishing Co., 1919), p. 105.
- ◆ Byron C. Nelson, *The Deluge Story in Stone* (Minneapolis: Bethany Fellowship, Inc., 1968), pp. 169–190.
- ◆ “... there are many descriptions of the remarkable event [the Genesis Flood]. Some of these have come from Greek historians, some from the Babylonian records; others from the cuneiform tablets, and still others from the mythology and traditions of different nations, so that we may say that no event has occurred either in ancient or modern times about

which there is better evidence or more numerous records, than this very one which is so beautifully but briefly described in the sacred Scriptures. It is one of the events which seems to be familiar to the most distant nations—in Australia, in India, in China, in Scandinavia, and in the various parts of America. It is true that many look upon the story as it is repeated in these distant regions, as either referring to local floods, or as the result of contact with civilized people, who have brought it from historic countries, and yet the similarity of the story is such as to make even this explanation unsatisfactory.” Stephen D. Peet, “The Story of the Deluge,” *American Antiquarian*, Vol. 27, July–August 1905, p. 203.

- ◆ C. H. Kang and Ethel R. Nelson, *The Discovery of Genesis* (St. Louis: Concordia Publishing House, 1979). This excellent book shows that the classical Chinese pictographs contain many stories and details found in the early chapters of Genesis. The earliest people of China, 4,000–5,000 years ago, brought with them stories of past events and the flood that became embedded in their language. [See Figure 40 on page 48.]

131. Was There Room?

- a. Actually, the Hebrew word for Ark (*tebah*) does not mean *boat*. It means “box,” “chest,” or “coffin.” Notice how the Ark depicted in Figure 41 on page 49 looks like a box, chest, or coffin. In the Bible, *tebah* occurs in only one other context besides the flood. (The “Ark of the Covenant” is a different Hebrew word.) Moses was saved as a baby in a pitch-covered ark, *tebah* (Exodus 2:3,5). Sometimes *tebah* is translated into a different English word, such as *basket*. Moses, perhaps acting as an editor, wrote the flood account. Don’t you suppose that Moses had a special interest in describing how a few people, his ancestors and ours, were saved in a *tebah*—as he was?
- b. The most detailed study of the many logistical requirements for the Ark and the number of animals on board is by John Woodmorappe, *Noah’s Ark: A Feasibility Study* (El Cajon, California: Institute for Creation Research, 1996).
- c. “The event of the koa dispersal is a giant fluke, but that’s part of the message of a lot of recent biogeographic studies: that giant flukes happen.” Alan de Queiroz, as quoted by Emma Marris. “Tree Hitched a Ride to Island,” *Nature*, Vol. 510, 19 June 2014, pp. 320–321.
- ◆ “‘Things don’t go from islands,’ he says, ‘or at least that was the general thought.’” Ibid.
- d. “Koa seeds are unlikely to have floated to Réunion—they will not germinate after being soaked in seawater, and the trees grow in the mountains, not near the shore.” Marris.
- e. “The startling finding is the latest in a string of improbable long-distance dispersal events that have been uncovered in the past 15 years or so. ... Such findings have shaken up the field of biogeography, which concerns itself with why species are found where they are.” Ibid.



Figure 42: Fountains of the Great Deep. Notice the bulge of western Africa beginning to form.

Part II explains the hydroplate theory, a scientific explanation for the global flood. The easiest and quickest way to understand the basics of this theory is to first watch Bryan Nickel’s partially animated PowerPoint presentations. His visual explanations also provide an interesting, easy-to-understand, and accurate framework for other aspects of Part II. See:

www.youtube.com/c/BryanNickel_Hydroplate

Part II:

Fountains of the Great Deep

Had the events of the global flood been understood when Darwin proposed organic evolution in 1859, evolution and its many adverse social, scientific, and educational consequences probably would not have arisen. Here’s why.

If a culture ignored, for any reason, a past event as cataclysmic as a global flood, major misunderstandings or errors would creep into science and society. One of the first would be the explanation for fossils. Typically, Fossil A lies below Fossil B, which lies below Fossil C, etc. If flood explanations were weak, unbelievable, or censored, then evolution would provide an answer: Organism A evolved into B, which much later evolved into C. Fossil layers would represent vast amounts of time. Other geologic features could then easily fit into that time frame. With so much time available, possible explanations multiply—explanations not easily tested in less than a million years. Billions of people, most of whom were not scientifically sophisticated, would hear and be taught these million-and-billion-year explanations for much of their lives. Belief in those unimaginable time spans would become the cultural norm. A century after Darwin, evolutionary explanations would be given for the universe, chemical elements, heavenly bodies, Earth, and life. Part I of this book shows that those ideas are false.

Part II will show, in ways an interested layman can understand, the flaws in those geologic explanations and that *a global flood, with vast and unique consequences, did occur*. For example, coal, oil, and methane did not form over hundreds of millions of years; they formed in months. Fossils and layered strata did not form over a billion years; they formed in months. The Grand Canyon did not form in millions of years; it formed in weeks. Major mountain

ranges did not form over hundreds of millions of years, but in less than an hour! Radioisotopes didn’t form over a billion years and then decay over billions of years; both were mostly completed in hours! These statements are shocking, until we carefully examine the evidence in Part II.

You will be hard-pressed to find anyone willing to debate these matters with someone who understands the flood. [See pages 570–571.] However, if you are the first to find someone with an earned doctoral degree in basic or applied science to rebut these statements and the conclusion of Part I (that evolution is bankrupt) and that person completes a written, publishable debate with me—then a \$10,000 finders fee will be yours. [See page 570 for details.]

Ironically, some leading creationists who *believe* in a global flood have contributed to its frequent rejection by advocating unsound *mechanisms* for the flood. They have failed to answer people’s most basic questions, such as: “*Where did so much water come from, and where did it go?*”

One such explanation is the canopy theory. (Pages 518–526 examine its many problems.) Others who know of these problems have proposed an equally weak explanation called *catastrophic plate tectonics*. Basically, it is a flawed plate tectonic theory sped up a millionfold by conveniently assuming miracles and unworkable mechanisms. Page 500 gives one reason the plate tectonic theory has been falsified.

Past failure to answer honest flood questions opened the door to evolution and old-Earth beliefs. Answering those questions will begin to (1) reestablish the flood as Earth’s defining geological event, and (2) reverse serious errors that have crept into science and society. Don’t be surprised at how catastrophic the flood was. Just follow the evidence.



Figure 43: The Grand Canyon. Probably the most spectacular of the seven wonders of the natural world is the Grand Canyon. It is awesome when viewed from its rim, but even more so from the air. From above, new insights become obvious, as you will see. For example, have you ever wondered how the Grand Canyon formed? Since the late 1800s, the standard answer has been that primarily the Colorado River carved the Grand Canyon over millions of years. If that happened, wouldn't you expect to find a gigantic river delta where the Colorado River enters the Gulf of California? It's not there. Nor have geologists found it anywhere else. Where did all the dirt go—2,800 cubic miles of it?

Notice the four segments of this river near the center of the picture. Compare the thin river with the canyon's vast expanse. Could that relatively small river carve such a huge, wide, and deep canyon? If so, why hasn't the same thing happened along dozens of faster and larger rivers? Why do hundreds of large side canyons, with no visible water source to erode them, enter the Grand Canyon?

In first studying this overview chapter and then the chapter on the Grand Canyon (pages 214–257), you will see a gigantic, focused water source and a surprisingly simple, but complete, explanation for the Grand Canyon's rapid formation as well as where all the dirt went. As you might expect, the Grand Canyon's origin is directly related to the origin of many other amazing and mysterious sights in the southwestern United States.

The Hydroplate Theory: An Overview

New evidence shows that the Earth has experienced a devastating, worldwide flood, whose waters violently burst forth from under Earth's crust. Standard "textbook" explanations for many of Earth's major features are scientifically flawed. We can now explain, using well-understood phenomena, how this cataclysmic event rapidly formed so many features. These and other mysteries, listed below and briefly described in the next 11 pages, are best explained by an earthshaking event, far more catastrophic than almost anyone has imagined. Entire chapters are devoted to the italicized topics listed below.

- ◆ *The Grand Canyon* (pages 215–257)
- ◆ Mid-Oceanic Ridge
- ◆ Earth's Major Components
- ◆ *Oceanic Trenches, Earthquakes, and the Ring of Fire* (pages 153–192)
- ◆ Magnetic Variations on the Ocean Floor
- ◆ Submarine Canyons
- ◆ Coal and Oil
- ◆ Methane Hydrates
- ◆ Ice Age
- ◆ *Frozen Mammoths* (pages 267–299)
- ◆ Major Mountain Ranges
- ◆ Overthrusts
- ◆ Volcanoes and Lava
- ◆ Geothermal Heat
- ◆ *Strata and Layered Fossils* (pages 195–213)
- ◆ *Limestone* (pages 260–266)
- ◆ Metamorphic Rock
- ◆ Plateaus
- ◆ The Moho and Black Smokers
- ◆ Salt Domes
- ◆ Jigsaw Fit of the Continents
- ◆ Changing Tilt of Earth's Axis
- ◆ *Comets* (pages 301–335)
- ◆ *Asteroids, Meteoroids and TNOs* (pages 337–377)
- ◆ *Earth's Radioactivity* (pages 379–433)

Each appears to be a consequence of a sudden, unrepeatable event: a global flood whose waters erupted from interconnected, worldwide subterranean chambers with a *directed* energy release—focused upward—that exceeded the explosion of trillions of hydrogen bombs.¹ *The hydroplate theory*, explained later in this chapter, will resolve all these mysteries.

But first, what is a *hydroplate*? Before the global flood, an ocean of water was under Earth's crust. Pressure increases in this subterranean water ruptured that crust, breaking it into *plates*. The escaping water flooded the Earth. Because *hydro* means water, those crustal plates will be called *hydroplates*. Where and why they broke, how they moved, and hundreds of other details and evidence—all consistent with the laws of physics—explain so many of Earth's major features and constitute the hydroplate theory.

Plate tectonics, currently the most widely taught theory in the Earth sciences, has many little-known problems. According to this theory, Earth's crust is composed of many plates,² each 30–60-miles thick. They move relative to each other, about an inch per year—at the rate a fingernail grows. Continents and oceans ride on top of these plates. Some continents, such as North America, are on more than one plate. For example, different parts of North America, separated by the San Andreas Fault running up through western California, are sliding past each other. (A fault is a large fracture in the Earth along which slippage has occurred.) Supposedly, material deep inside the Earth is rising toward the crest of the entire Mid-Oceanic Ridge—a strange feature that wraps around the Earth like the seam of a baseball. This claimed motion, called seafloor spreading, would be similar to that of two conveyor belts rising together from under a floor and then moving along the floor in opposite directions. If plate tectonics happens on Earth, why is it not seen on other planets?³ As you will see on page 500, **recently declassified data falsifies the plate tectonic theory.**

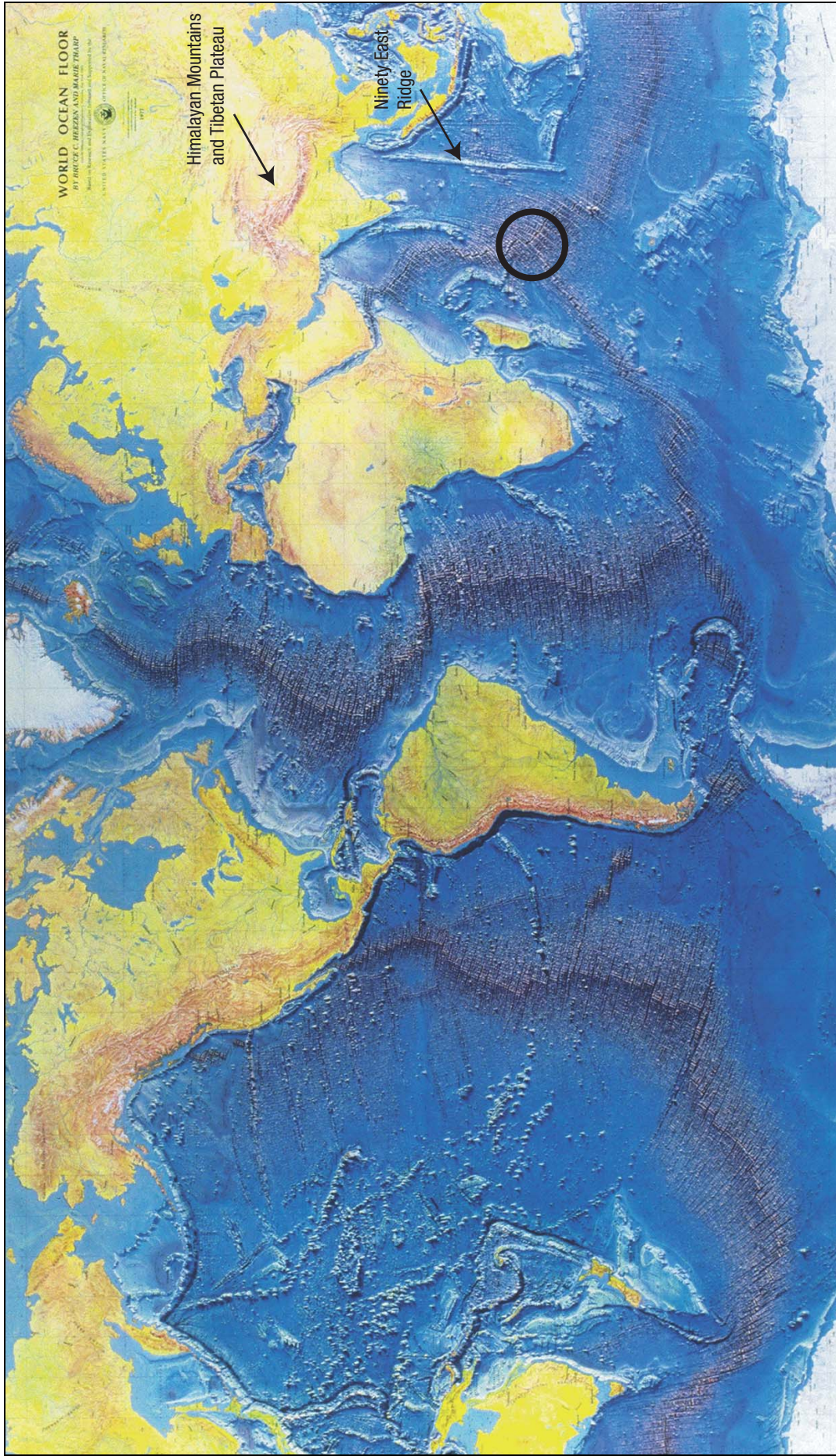

Figure 44: World Ocean Floor by Marie Tharp. Notice the characteristic margins of each continent. Seaward from each ocean beach is a shallow, gradually sloping *continental shelf*, then a relatively steep drop, called the *continental slope*. This strange pattern is worldwide. Why? For a better look at the typical shape of this margin, see Figure 47 on page 115. Also, notice the different characteristics of (1) continents and ocean basins, and (2) the Atlantic and Pacific Basins. *Ninety East Ridge* is so named because it lies almost exactly along 90°E longitude. Its straight, 3,000-mile length and curious north-south orientation aimed at the Himalayas are important clues to past events on Earth. (Note: As one moves toward polar regions on this type of map projection, east-west distances are stretched and do not reflect true distances.) Why does the Mid-Oceanic Ridge intersect itself in the Indian Ocean (shown by the black circle)? The Plate tectonic theory says the seafloor is spreading along the Mid-Oceanic Ridge. So at the intersection point, spreading should be occurring in **four** directions—on both sides of two ridge axes. Is a deep hole opening up at that point? Obviously not! As will be explained with many more examples in this and the next chapter, *seafloor spreading is a myth*. That alone falsifies plate tectonics. The hydroplate theory provides a simple explanation for that intersection point and the Mid-Oceanic Ridge. [See “**Does Recently Declassified Data Falsify Plate Tectonic Theory?**” on page 500.]

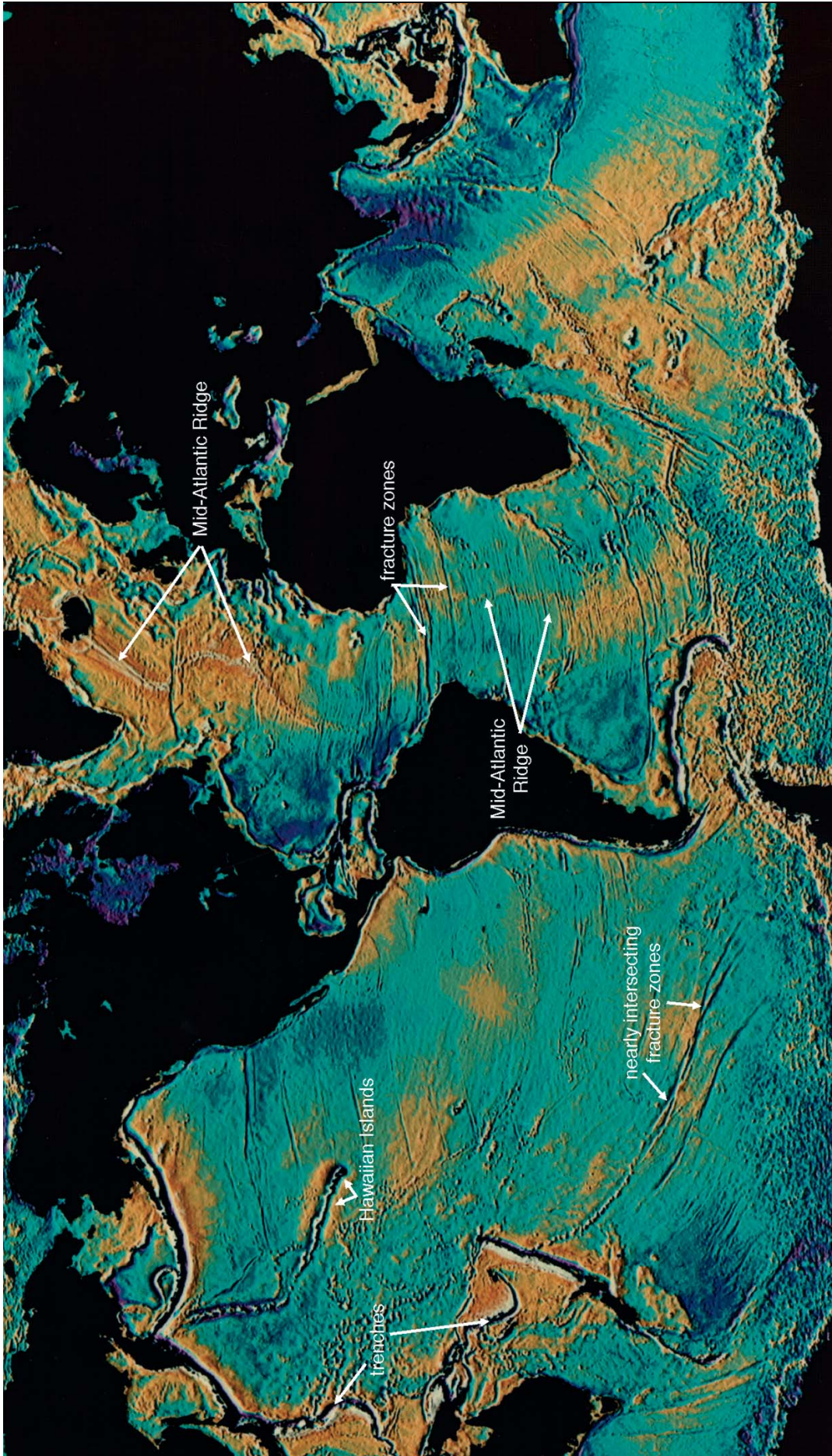

Figure 45: “Unlevel” Sea Level. An amazing technological development reveals details on ocean floors.⁴ In 1983, the U.S. Navy’s SEASAT satellite measured with a radar altimeter the satellite’s distance above the ocean surface with an accuracy of several inches! “Sea level” is far from level. Instead, the ocean surface “humps up” over mountains on the ocean floor and is depressed over trenches. The gravitational attraction of the Hawaiian Islands, for example, pulls the surrounding water toward them, raising sea level there about 80 feet higher than it would be otherwise. The satellite’s data have been color coded to make this spectacular “picture” of the ocean surface. Darker areas show depressions in sea level. Notice that the ocean surface is depressed over long scars, called *fracture zones*, running generally perpendicular to the Mid-Oceanic Ridge. Which theory explains this—the plate tectonic theory or the hydroplate theory? Also consider the nearly intersecting fracture zones in the South Pacific. Which theory explains them? This technique for showing features on the ocean floor has steadily improved since 1983. Today, ridges and fracture zones can be seen in places that are inconsistent with the plate tectonic interpretation. For example a *crooked* fracture zone can be traced from South America to Africa, and oceanic ridges are found *in the Gulf of Mexico*. As you will see, both are consistent with the hydroplate theory.

Crisis in Earth Science. The most perplexing question in the Earth sciences today is barely mentioned in classrooms and textbooks: *What force moves plates over the globe?*

The single most difficult question that faces the theory of plate tectonics today is the same question that led to the downfall of Wegener's [1912] theory of continental drift. ... That is, what is the mechanism that drives the plate tectonic machine?"⁵

The hydroplate theory gives a surprisingly simple answer that will be clear by the end of this chapter. It involves gravity, the Mid-Atlantic Ridge, Earth's core, and water—lots of it. Be patient, and read the next 37 pages carefully.

A Few of the Mysteries

The Grand Canyon and Other Canyons. See Figure 43.

Mid-Oceanic Ridge. This 46,000-mile-long ridge, discovered in the 1950s, is the world's longest mountain range. It wraps around the Earth on primarily a *great-circle path*. [See Figure 44 on page 112.] Unlike most mountains, it is composed of a type of rock called *basalt*. Because most of the ridge lies on the ocean floor, relatively few people know it exists. How did it get there? Why is it primarily on the ocean floor? Why does it intersect itself in a Y-shaped junction in the Indian Ocean? The portion in the Atlantic Ocean is called the *Mid-Atlantic Ridge*. Is it just a coincidence that it splits the Atlantic from north to south and is generally perpendicular to and bisected by the equator? If Europe, Africa, and the Americas were once connected, how did they break apart?

Cutting across the Mid-Oceanic Ridge, at almost right angles, are hundreds of long cracks, called *fracture zones*. Whenever the axis of the Mid-Oceanic Ridge is offset, it is always along a fracture zone. [See Figure 45 on page 113.] Why? According to plate tectonics, plates move parallel to fracture zones. But fracture zones are not always parallel. Sometimes they are many degrees “out of parallel.”⁶ How then can solid plates be bounded by and move in the direction of these fracture zones? (Can a train move on tracks that aren't parallel?) Notice the white arrows in Figure 45 showing nearly intersecting fracture zones.

In at least eight places on the Atlantic and Pacific floors, segments of the Mid-Oceanic Ridge overlap for about 10 miles. They are called *overlapping spreading centers*.⁷ [See Figure 46.] If plates are moving away from the Mid-Oceanic Ridge, then the distance between overlapping segments must be increasing. However, overlapping regions are always near each other—contradicting plate tectonics.

Earth's Major Components. What accounts for Earth's oceans, continents and their boundaries (shelves and slopes), crust, mantle, and core (inner and outer)? Why are the shapes of continental shelves and slopes so uniform worldwide? [See Figures 44 and 47 and Figure 87 on page 157.]

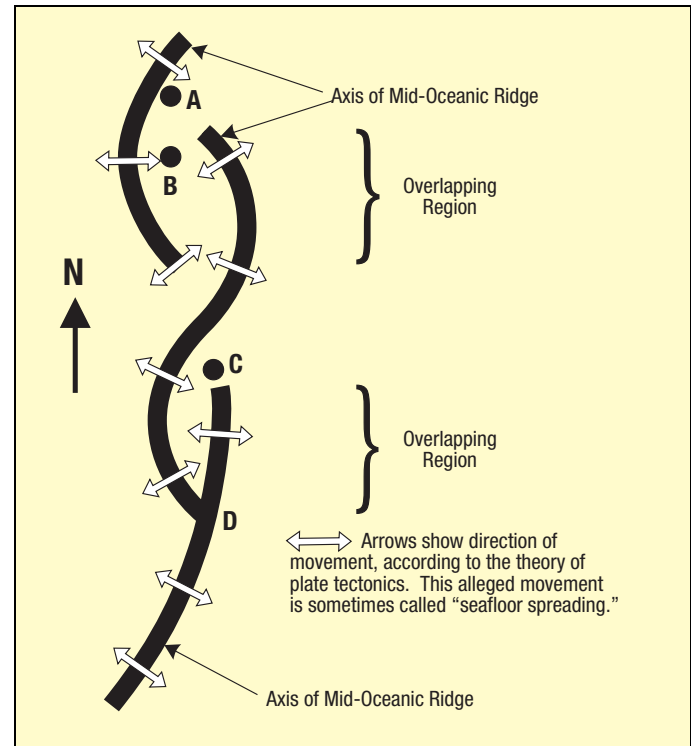

Figure 46: Overlapping Spreading Centers. Bold lines represent the axes of the Mid-Oceanic Ridge. According to plate tectonics, the ocean floor is moving in the direction of the white arrows—away from the Mid-Oceanic Ridge. If so, in which direction is point B moving? If B is stationary, and A is moving east, why is there no fault between them? What is happening at C and D if the plate tectonic theory is correct? *Obviously, the sea floor is not spreading.* Later, these overlaps will be shown to support the hydroplate theory.

Low-salinity water is being discovered far below continental shelves worldwide. Why would water, typically less salty than sea water, be found beneath the sea floor?⁸

Ocean Trenches. Ocean trenches are long, narrow depressions on the ocean floor, some of which are several times deeper than the Grand Canyon. They can be seen in the western Pacific in Figures 44, 45, and 83. Plate tectonics claims that a trench forms when a plate dives down into the mantle at a 30°–60° angle below the horizontal, a process advocates call *subduction*. How this dive begins is never explained. This would be similar to pushing a 30-mile-thick shovel into the ground. What pushes a continental-size plate down at such a steep angle? If subduction occurs, why do instruments detect almost no distortion of the horizontal sedimentary layers in trenches? Worse yet, if any plate reached a depth of only several miles, pressures would be so great that frictional forces would exceed the rock's strength. Therefore, large-scale sliding of a relatively thin slab by pushing, pulling, or dragging should be impossible. [See page 593.] This is similar to trying to push our 30-mile-thick shovel, now pinched in the jaws of a vise, down farther. It may break, buckle, deform, or crush, but it will not slip. (*The next chapter will show that deep faults have been misinterpreted as subducting plates.*)

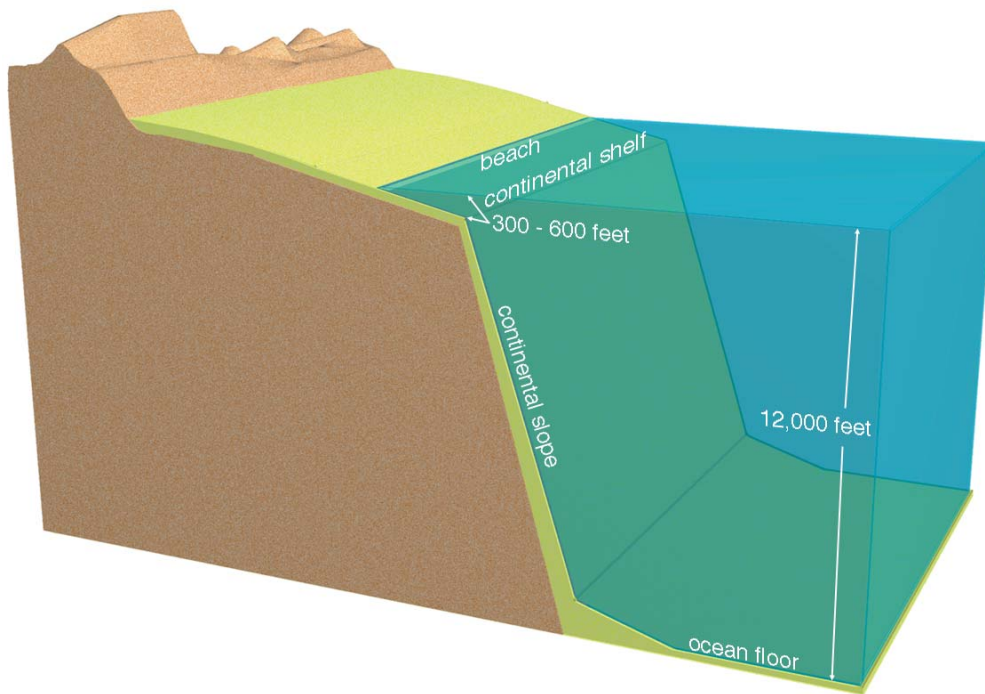

Figure 47: Continental Margin. The typical shape of ocean-continent boundaries worldwide is shown here. The actual continental boundary is generally considered to be halfway down the continental slope. Compare this figure with Figure 44 on page 112, and notice that Asia and North America would become connected by a wide land bridge if sea level were lowered about 300 feet. Australia and Asia would be almost connected. Sediments and sedimentary rock are shown in yellow.

With so much ice on the continents during the height of the ice age (a few centuries after the flood), sea level was temporarily about 400 feet lower than it is today. Therefore, land animals and humans could then have easily migrated between all continents.

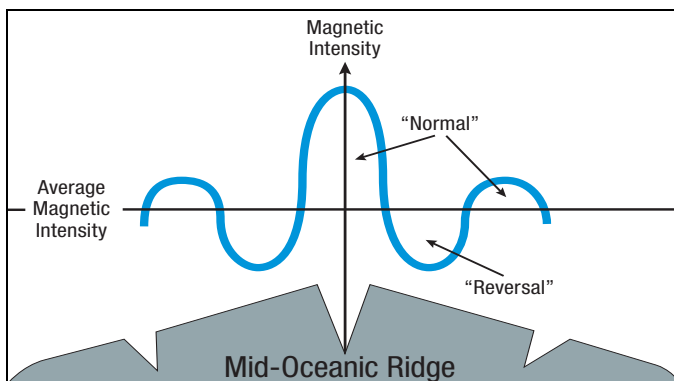

Figure 48: Magnetic Anomalies. Notice the fluctuations in magnetic intensity as one moves across the Mid-Oceanic Ridge. The so-called *reversals* are simply regions of lower magnetic intensity. Why is the intensity greatest along the crest of the ridge?

Magnetic Variations on the Ocean Floor. At a few places along the Mid-Oceanic Ridge, magnetic patterns on one side of the ridge are almost a mirror image of those on the other side. The plate tectonic theory gained wide acceptance in the 1960s when this surprising discovery was misinterpreted.

Some people proposed that these variations were caused by periodic reversals of the Earth's magnetic field, although there is no theoretical understanding of how that could happen.⁹ Supposedly, as molten material moves away from the ridge (in seafloor spreading) over millions of years, the magma solidifies, and its magnetic material is locked in the orientation of the Earth's magnetic field at the time. Thus, a record of past "flips" of Earth's magnetic field is preserved in rocks at different distances from the ridge.

That explanation is wrong, as detailed magnetic maps clearly show. No compass, shielded from Earth's magnetic field, would reverse direction whenever it crossed an alleged (and misleading) reversed band. However, as one moves across the Mid-Oceanic Ridge, magnetic intensities fluctuate, as shown in Figure 48. Someone merely drew a line through these fluctuations and labeled everything below this average intensity as a "reversal." There is a false but widespread impression that these slight deviations below the average represent magnetic fields that reversed millions of years ago. Calling these fluctuations reversals causes one to completely miss a more likely explanation.

Although textbooks show these so-called "reversals" as smooth bands paralleling the Mid-Oceanic Ridge for thousands of miles, there is nothing smooth about them. Some "bands" are even perpendicular to the ridge axis—the opposite of what plate tectonics predicts. Also, the perpendicular "bands" correspond to fracture zones.¹⁰ The hydroplate theory offers an explanation for these magnetic anomalies. [See "[No Seafloor Spreading](#)" on page 176.]

A few lava flows show that rapid but limited changes in Earth's magnetic field have occurred. Lava cools at known rates, from the outside of the flow toward its center. Magnetic particles floating in lava align themselves with the Earth's magnetic field. When the lava cools and solidifies, that orientation becomes fixed. Knowing this cooling rate and measuring the changing directions of the magnetic particles within several solidified lava flows, shows that at one time Earth's magnetic field shifted rapidly—by up to 6 degrees per day for several days.¹¹ (Note: This does not mean Earth's magnetic field periodically flips.)

Submarine Canyons. The ocean floor has hundreds of canyons, some that exceed the Grand Canyon in both length and depth. One submarine canyon is ten times longer (2,300 miles), so long it would stretch nearly across the United States.¹² Many of these V-shaped canyons are extensions of major rivers. Examples include the Amazon Canyon, Hudson Canyon, Ganges Canyon, Congo Canyon, and Indus Canyon. How were canyons gouged out, sometimes 15,000 feet below sea level? Did ancient rivers (or major drainage paths) cut these canyons when sea level was lower or the ocean floor was higher? If so, why did those elevations change? Swift rivers supposedly cut most continental canyons. However, currents measured in submarine canyons are too slow, generally less than one mile per hour. Frequently, the flow is in the wrong direction. Submarine landslides that produce dense, muddy currents sometimes occur. However, they would not form the long, tributary patterns that characterize river systems and submarine canyons. Furthermore, experiments with thick, muddy water in submarine canyons have not demonstrated any canyon-cutting ability.

Coal and Oil Formations. Large fossilized trees are found near the North and South Poles.¹³ In Antarctica, some fossilized trees are 24 feet long and 2 feet thick! Nearby are 30 layers of anthracite (or high-grade) coal, each 3–4 feet thick.¹⁴ Buried redwood forests, with trees more than 100 feet long and root structures showing that they grew in place, are found on Canadian islands well inside the Arctic Circle.¹⁵ Much oil is also found inside the Arctic Circle. Was it once warm enough for trees to grow in Antarctica or inside the Arctic Circle? If so, how could so much vegetation grow where it is nighttime 6 months of the year? Were these cold lands once at temperate latitudes? Not according to plate tectonics, which places both regions near their present latitudes when their now-fossilized forests were growing.¹⁶

Methane Hydrates. Some bacteria can live without oxygen. They feed on organic matter and produce methane gas, a combustible fuel. Since 1970, methane has been discovered inside ice mixed within sediments lying up to 8,000 feet below the deep ocean floor off coastlines.¹⁷ The ice molecules form microscopic cage-like structures encasing one or more methane molecules. The total energy value of this methane-ice combination, called *methane hydrate*, is at least twice that of all the world's known coal and oil combined!¹⁸

Why is so much methane buried along coastlines? How did all the bacteria, that produced the methane, get there, and what was their gigantic source of food? The largest single deposit known, named “Hydrate Ridge,” lies off Oregon's coast. According to plate tectonics, that part of the seafloor is sliding under North America, and should be removing the methane hydrates. However, there is — along all coast lines worldwide, just as there are where seafloors are not supposedly subducting. [See Figure 49.]



Figure 49: Flaming Ice. This ice contains methane, a flammable gas. Water will freeze at slightly warmer temperatures than normal if it is under high pressure and contains dissolved methane. Such temperatures and pressures exist 2,000 feet or more below sea level. There, vast methane deposits are found trapped in ice on and under the deep seafloor, primarily along coastlines. How did so much methane get there?

Ice Age. An ice age implies extreme snowfall which, in turn, requires cold temperatures and heavy precipitation. Heavy precipitation can occur only if oceans are warm enough to produce heavy evaporation. How could warm oceans exist with cold atmospheric temperatures?

Another problem is stopping an ice age once it begins—or beginning a new ice age after one ends. As glaciers expand, they reflect more of the Sun's radiation away from Earth and lower temperatures, causing glaciers to grow even more. Eventually, the entire globe should freeze permanently. Conversely, if glaciers shrink, as they have in recent decades, the Earth should reflect less heat into space, warm up, and eventually melt all glaciers.

Don't be misled by claims that hundreds of thousands of layers of glacial ice can be counted, and therefore the ice age began hundreds of thousands of years ago. Yes, layers can be

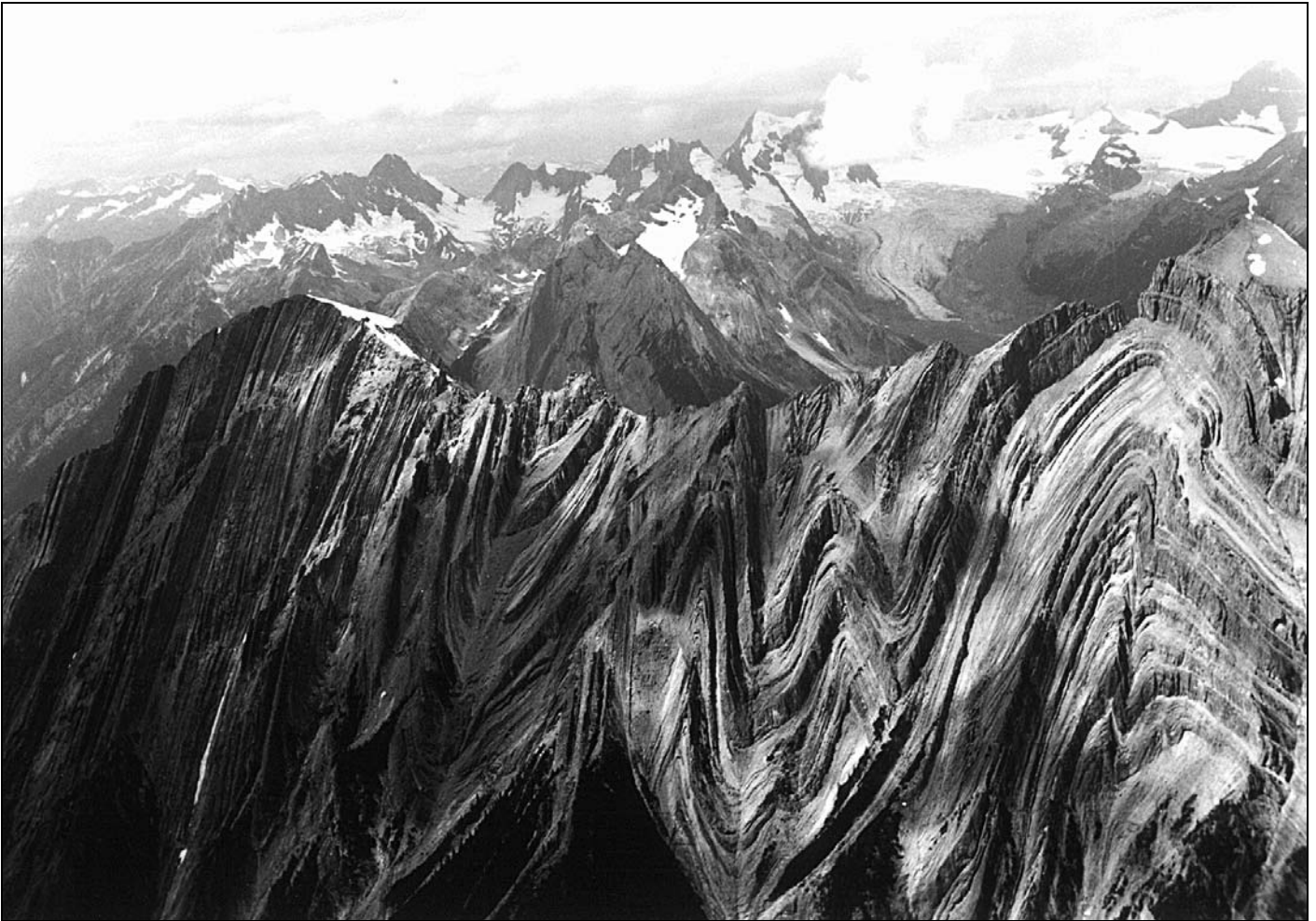

Figure 50: Buckled Mountain. Textbooks and museums frequently refer to some uplifting force that formed mountains. Can you see that an uplifting force, by itself, would not produce this pattern? Horizontal compression was needed to buckle these sedimentary layers near the Sullivan River in southern British Columbia, Canada. Such layers—seen worldwide—must have been soft, like wet sand, at the time of compression. Today, surface rocks are brittle.

seen in ice cores extracted from deep in glaciers in Antarctica and Greenland, but less than 2,000 annual layers can be counted visually for a very simple reason. The weight of the overlying layers have compressed all the layers below. They are now so thin that the eye can no longer count them.

To justify hundreds of thousands of layers, mathematical models are created in which some measured characteristic of the ice core (such as dust content, acidity, or various chemical isotopes) is measured along every millimeter of the core's length. Then, mathematical curves having hundreds of thousands of cycles are fit to the data. Missing is the statistical analysis showing that the fit is significant—that the data (such as dust content, acidity, or the variation pattern of oxygen-18) is not random noise. If laymen are not impressed by the claim that it took 800,000 “years” for all those cycles to be laid down, those same laymen may be impressed by the technical jargon describing the oxygen-18 or acidity measurements. **Hidden is the simple fact that less than 2,000 true annual layers can be counted—even with magnification.**¹⁹

Major Mountain Ranges. How did mountain ranges form? Mountains are often crumpled like an accordion. [See [Figure 50](#).] Satellite photos of mountain ranges show that some resemble throw rugs that have been pushed against walls. But what force could push a long, thick slab of rock and cause it to buckle and sometimes fold back on itself? Any force large enough to overcome the gigantic frictional resistance at the base of a slab that is longer than 8 miles, would crush the end being pushed before movement could even begin. Therefore, a mountain would not form. [See [“Key Requirements for Folding Strata, Buckling Mountains, and Overthrusting”](#) on page 204.]

We can see, especially in mountains and road cuts, thinly layered rocks folded like doubled-over phone books. Other “bent” rocks are small enough to hold in one's hand. The tiny, crystalline grains in those folds are not stretched. So, how could brittle rock, showing little evidence of heating or cracking, fold? Rocks are strong in compression but weak in tension, so their stretched outer surfaces should have easily fractured. Bent sedimentary rocks, found worldwide, often look as if they had the consistency

of putty when they were compressed. They must have been squeezed and folded soon after the sediments were laid down, but before they hardened chemically. What squeezed and folded them?

Frozen Mammoths. Fleishy remains of about 50 elephant-like animals called *mammoths*, and a few rhinoceroses, have been found frozen and buried in Siberia and Alaska. One mammoth still had identifiable food in its mouth and digestive tract. To reproduce this result, one would have to *suddenly* push a well-fed elephant (dead or alive) into a very large freezer that had somehow been precooled to -150°F . Anything less severe would result in the animal's internal heat and stomach acids destroying its food. If the animal remained alive for more than a few minutes, one would not expect to find food in its mouth. What could cause such a large and sudden temperature drop? Even if the Sun suddenly stopped shining, Earth's temperature would not drop rapidly enough to produce such effects. Finally, these giant animals would have to be buried in what was presumably frozen ground—quite a trick.

How could large herds of elephant-like animals, each requiring much food, live in the Arctic? Even if the Arctic were warm, the lack of winter sunlight would allow far less vegetation to grow than is needed to sustain so many large animals. Today, the average January temperature in northern Siberia is -28°F . Your nose gets cold after a few minutes in $+32^{\circ}\text{F}$ weather. Consider how you would feel if your nose were a 6-foot-long trunk and the average temperature were a frigid 60°F *colder* for weeks. Where would you, or a mammoth, find drinking water?

Overthrusts. For over a century, geologists have struggled unsuccessfully to explain *overthrusts*—large blocks of rock, hundreds of feet thick and hundreds of miles long, that have slid horizontally over other rocks for 50 miles or more. Such blocks should have considerable rubble under them. Many have none. Pushing a large slab of rock with enough force to overcome the gigantic friction would crush the slab before it would move. Those who appreciate this problem simply say that the pore pressure of water in rocks must have lubricated the sliding, and the slab slid downhill. What is overlooked is that rocks do not contain nearly enough water to do this, and overthrust blocks are seldom on steep slopes.

Volcanoes and Lava. Erupting lava usually exceeds $2,000^{\circ}\text{F}$. Where does it come from, and why is it so hot? Earth's mantle and inner core are essentially solid. Only the outer core, which lies 1,800–3,200 miles below the Earth's surface, is a liquid. The standard explanation is that lava (called *magma* when it is inside the Earth) originates in hot pockets, called *magma chambers*, at depths of about 60 miles, but how did it get there? Then, how could magma escape to the surface? A key fact to remember is that at depths greater than about 5 miles, pressures are so great that all empty channels through which magma might rise should be squeezed shut.²⁰ Even

if a crack could open, the magma must rise through colder rock. Unless this happened quite rapidly, magma would cool, solidify, and plug up the crack. Also, heat diffuses. So, what concentrated enough heat to create the “hot pockets” and melt vast volumes of rock that erupted in the past?

On the Columbia Plateau in the northwestern United States, 64,000 square miles of lava, with an average depth of $\frac{2}{3}$ mile, spilled out rapidly under water.²¹ On the Deccan Plateau in western India, 200,000 square miles have been flooded with lava to an average depth of $\frac{3}{4}$ mile. In southwestern Siberia, lava deposits are many times larger. Four times more magma spilled out on the Ontong-Java Plateau (on the floor of the western Pacific) than on the Deccan Plateau. How did so much magma form, and how did it get out?

Two of the world's deepest drill holes are on the Kola Peninsula in northern Russia and in Germany's northeastern Bavaria.²² They were drilled to depths of 7.6 miles and 5.7 miles, respectively. Deep in the Russian hole, to everyone's surprise, was hot, salty water flowing through *crushed* granite.²³ Why was the granite crushed? In the German hole, the drill encountered cracks throughout the lower few miles. All cracks contained saltwater with salt concentrations about *twice that of seawater*. Remember, surface waters cannot seep deeper than 5 miles, because the weight of overlying rock squeezes shut even microscopic flow channels.²⁰

Geologists are mystified by this deep saltwater. Another surprise was greater-than-expected increases in the granite's temperature with increasing depth—so much so that each drilling project was terminated early. This raises the question of why the Earth's crust is so hot. The hydroplate theory provides a simple answer.

Geothermal Heat. Heat inside the Earth is called *geothermal heat*. The deeper man has gone into the Earth—first in deep caves and mines and later with drills—the hotter the rock generally gets. What is the origin of geothermal heat? As children, most of us were told the Earth slowly grew (evolved) by meteoritic impacts that melted the Earth, so geothermal heat is what remains after billions of years.

This popular story has several problems. First, the rate of temperature increase with depth, called the *temperature gradient*, varies, even in rock far from volcanoes, by at least a factor of six.²⁴ If the Earth has been cooling for billions of years, one would expect very uniform temperature increases with depth at most locations. Unusually hot or cold regions should not exist, because heat diffuses from hotter to colder regions.

Mathematical solutions for heat conduction in spheres, such as the Earth, are well known. These solutions can incorporate many facts, including the Earth's thermal properties, radioactive heat generation, and temperatures at the Earth's surface. Such analyses are hopelessly inconsistent with the “molten-Earth” story and “billions

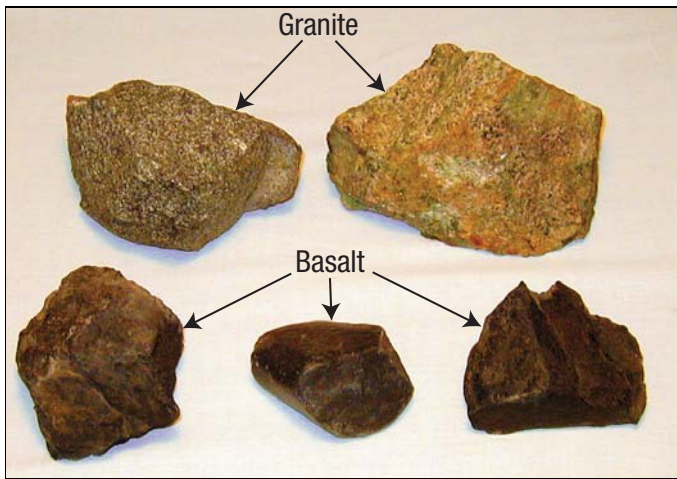

Figure 51: Granite and Basalt. Granite, the primary continental rock, has a grayish-to-pinkish color. Coarse grains of quartz, which have a glassy luster, occupy about 27% of granite's volume. Basalt, the most common rock beneath oceans today, is solidified lava—a dark, fine-grained rock. The hydroplate theory assumes that before the flood, granite was above the subterranean water and the mantle was below. As you will see, during and after the flood, molten basalt spilled out onto the chamber floor, so most ocean floors today are paved with basalt.

of years of cooling.” [See “**Molten Earth?**” on page 28 and “**Rapid Cooling**” on page 41.] What then generated geothermal heat, and why does it still vary so widely?

Strata. Earth's crust is frequently stratified with layered rock (or *strata*) composed of *cemented sediments*. These layers are typically parallel, thin, uniform in thickness, vast in area, and, within mountains and under valleys, tipped at all angles. Often one layer rests on another having a completely different texture, color, and mineral content. What global process sorted and cemented these sediments? Present processes do not.

Why are strata so uniform in hardness? If truckloads of sand and other dry sediments were dumped on your yard and bags of cement were placed in another pile, anyone would have difficulty mixing them uniformly. Without a uniform mixture of cementing agent, concrete (and sedimentary rock) would quickly crumble.

Limestone. A typical cementing agent in sedimentary rock is calcium carbonate (CaCO_3)—commonly called *limestone*. Any geologist who stops to think about it should realize that, based on present processes, the Earth has too much limestone. Sediments and sedimentary rock on the continents average about a mile in thickness and contain 10–15% limestone.²⁵ How did so much limestone form—much of it quite pure? Limestone, without the impurities that normally drift in, suggests rapid burial. Most limestone is in vast layers, tens of thousands of square miles in area and hundreds of feet thick. Today, limestone forms either as it precipitates out of seawater or as sea creatures manufacture shells and corals containing

limestone. In either case, oceans supply limestone sediments, but oceans already contain about as much dissolved limestone as they can possibly hold. So, where did all the limestone come from, especially its calcium and carbon, which are relatively rare outside of limestone?

Metamorphic Rock. Rocks change structurally and chemically when their temperatures and/or pressures exceed certain high values. The new rock is called a *metamorphic rock*. For example, limestone becomes marble (a metamorphic rock) when its temperature exceeds 1,600°F and confining pressures correspond to the weight of a 23-mile-high column of rock. Diamonds, another metamorphic rock, form under confining pressures corresponding to the weight of a 75-mile-high column of rock and 1,600°F, yet diamonds are found in crustal rocks that were never deep.²⁶ Most metamorphic rocks were formed in the presence of water, often flowing water.²⁷ What accounts for the extreme temperature, pressure, and abundance of water needed to form metamorphic rock?

The standard answer is that the original rock, such as limestone, was heated and compressed under a tall mountain or deep in the Earth. Later, over millions of years, either the mountain eroded away or the deep rock rose to Earth's surface. It is difficult to imagine mountains 23 or 75 miles high, because the world's tallest mountain, Mount Everest, is only 5½ miles high. Raising buried layers of rock 23 or 75 miles to the Earth's surface is even more difficult to explain, but with millions of years supposedly available, few consider the problem. Most don't know of the problem, and almost no one addresses it.

Plateaus. Plateaus are relatively flat regions of extensive area that have been uplifted (not buckled) more than 500 feet relative to surrounding regions. A plateau contains nearly horizontal rock layers. The same sequence of horizontal layers surrounds the plateau, but at a lower elevation. Professor George C. Kennedy clearly explains some problems associated with plateaus.

The problem of the uplift of large plateau areas is one which has puzzled students of the Earth's crust for a very long time. ... Given an Earth with sialic [granitic] continents floating in denser simatic [basaltic] substratum, what mechanism would cause a large volume of low standing continents to rise rapidly a mile in the air? Furthermore, evidence from gravity surveys suggests that the rocks underlying the Colorado plateau are in isostatic balance, that is, this large area is floating at its correct elevation in view of its mass and density. Recent seismic evidence confirms this, in that the depth to the M discontinuity [the Moho, explained below] under the Colorado plateau is approximately 10 kilometers [6 miles] greater than over most of continental North America. Thus, appropriate roots of light rock extend into the dense substratum to account for the higher elevation

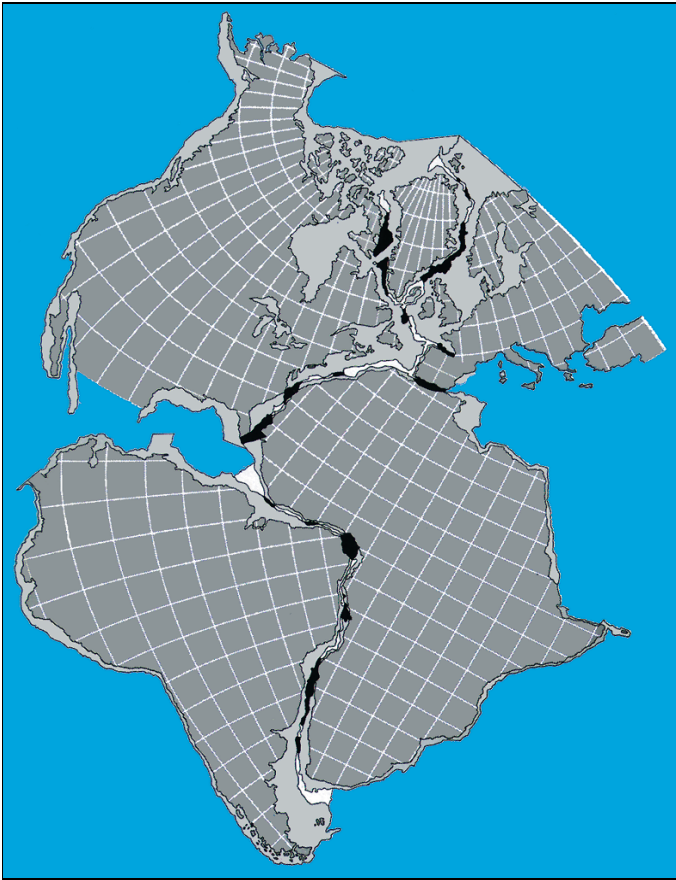

Figure 52: Continental Fit Proposed by Bullard. Can you identify five distortions in this popular explanation of how the continents once fit together? First, Africa was shrunk in area by 35%. Second, Central America, southern Mexico, and the Caribbean Islands were removed. Third, Australia is ignored, because its fit anywhere is problematic—and where is Asia? Fourth, a slice was made through the Mediterranean, and Europe was rotated counterclockwise and Africa was rotated clockwise. Finally, North and South America were rotated relative to each other. Notice the rotation of the north-south and east-west lines. Scientific justifications are not given for any of these five distortions.

Overlapping areas are shown in black and gaps in the fit are in white. If a supercontinent simply broke apart, what did the breaking, and how could the pieces (plates) move? Each plate should be locked by friction to the rock it rested on? What accounts for the gaps and overlaps? Evidently, something wore away the edges of the plates after the supercontinent broke into plates.

Do you suppose that water, trapped below the crust, isolated each plate from what would otherwise be its rock foundation, and allowed the plates to move to where they are today? If so, that water, in escaping violently upward would have eroded the edges of the plates, producing the overlaps and gaps.

of the Colorado plateau. We have then a double-ended mystery, for the Colorado plateau seems to have grown downward at the same time that its emerged part rose upward. This is just as startling as it would be to see a floating cork suddenly rise and float a half inch higher in a pan of water. To date, the only hypothesis to explain the upward motion of large regions like the Colorado plateau is that of convection currents. Slowly moving convection currents in the

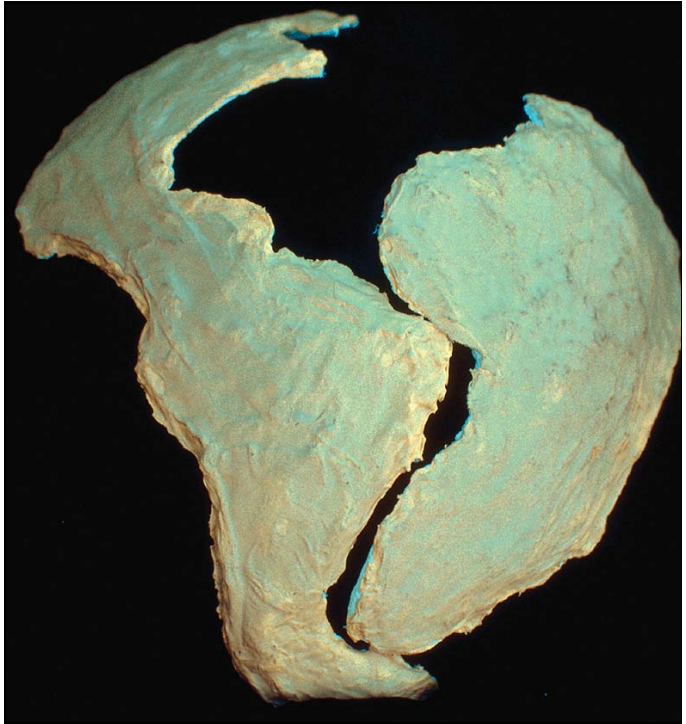

Figure 53: Poor Fit. Notice that the fit of the actual continents is not as good as Bullard proposed. [See Figure 52.]

solid rock, some 40 to 50 kilometers [25 to 30 miles] below the surface of the Earth, are presumed to have swept a great volume of light rock from some unidentified place and to have deposited it underneath the Colorado plateau. A total volume of approximately 2,500,000 cubic miles of sialic rock is necessary to account for the uplift of the Colorado plateau. While it is not hard to visualize rocks as having no great strength at the high pressures and temperatures existing at depths of 40 to 50 kilometers, it is quite another matter to visualize currents in solid rock of sufficient magnitude to bring in and deposit this quantity of light material in a relatively uniform layer underneath the entire Colorado plateau region.

The Tibetan plateaus present a similar problem, but on a vastly larger scale. There, an area of 750,000 square miles has been uplifted from approximately sea level to a mean elevation of roughly three miles, and the Himalayan mountain chain bordering this region has floated upward some five miles, and rather late in geologic time, probably within the last 20,000,000 years. The quantity of light rock which would need to be swept underneath these plateaus by convection currents to produce the effects noted would be an order of magnitude greater than that needed to uplift the Colorado plateau, that is, approximately 25,000,000 cubic miles. Even more troublesome than the method of transporting all this light rock at shallow depths below the surface of the Earth is the problem of its source. The region from which the light rock was moved should



Figure 54: Best Fit. By far the best fit of these continents is against the base of the Mid-Atlantic Ridge—not as shown in Figure 53. The distortions of Figure 52 are unnecessary and deceptive.

*have experienced spectacular subsidence, but no giant neighboring depressions are known. A lesser but large problem is how such enormous quantities of light rock can be dispersed so uniformly over so large an area.*²⁸

The Moho and Black Smokers. The Mohorovicic discontinuity, usually called the Moho, is the boundary between Earth's crust and mantle. The Moho was discovered in 1909 by seismologist Andrija Mohorovicic. He noticed that earthquake waves travel noticeably faster below the Moho than above. In the early 1960s, efforts were made to drill deep enough to penetrate and examine the Moho, but cost overruns and alleged mismanagement shut the project down after drilling only 601 feet into the seafloor. Today, drilling efforts are finding that above the Moho the "rock has been thoroughly fractured and is saturated with water; free water normally cannot migrate down to those depths!"²⁹ What is the Moho, why is the rock above fractured, and why does it contain liquid water? Figure 56 describes black smokers.

Salt Domes. Vast salt layers are sometimes buried as much as several miles below Earth's surface. Under the Gulf of Mexico is a single salt layer, called "the mother salt layer." It is at least 20,000 feet below sea level, 100,000 square miles in area, and 1,000 feet thick!³⁰ Many tall salt domes rise several miles above the mother salt layer; some salt domes are taller than Mount Everest! Large salt deposits are not being laid down today, even in the Great Salt Lake. What concentrated so much deep salt? Certainly, 20,000 feet of water did not evaporate.

A thicker "mother salt layer" with dozens of salt domes is also found under the Mediterranean Sea. A codiscoverer of these deposits, using refuted arguments,³¹ claims that the Mediterranean must have evaporated 8–10 times to deposit so much salt.³² His estimate is probably low, but even so, why didn't each refilling of the Mediterranean Basin redissolve the salt residue left from prior evaporations, allowing currents to remove the basin's salt?

Jigsaw Fit of the Continents. For centuries, beginning possibly with Francis Bacon in 1620, many have noticed the approximate jigsaw fit of the continents bordering the Atlantic. It is only natural that bold thinkers, such as Alfred Wegener in 1915, would propose that the continents were once connected as shown in Figure 52, and somehow they broke apart and moved to their present positions. But would continents, including their broad but submerged continental shelves, really fit together as shown in textbooks? Distances are distorted when a globe is flattened into a two-dimensional map. Therefore, to answer this question, I formed two plates on a globe, matching the true shape and curvature of the continents. [See Figure 54.]

The classical fit (Figure 52), proposed by Sir Edward Bullard, appears at first glance to be a better fit of the continents than my plates. However, notice in Figure 52's description the great "latitude" Bullard took in juggling continents. Were these distortions made to improve the fit? Few, if any, textbooks inform us of these distortions.

Instead of fitting the continents to each other, notice in Figure 54 how well they each fit the base of the Mid-Atlantic Ridge. The hydroplate theory proposes that:

- These continents were once in the approximate positions shown in Figure 54.
- They were connected by rock that was rapidly eroded and transported worldwide by erupting subterranean water.
- As these eroded sediments were deposited, they trapped and buried plants and animals. The sediments became today's sedimentary rock, and buried organisms became fossils.
- The continents quickly slid on a layer of water (rapid continental drift) away from the rising Mid-Atlantic Ridge and toward the subsiding Pacific floor. They came to rest near their present locations.

Why Do We Have Radioactivity on Earth?

This question stuns most people. Hasn't radioactivity always been? Not according to evolutionists. They say everything began with a big bang, which produced only the three lightest chemical elements: hydrogen, helium, and lithium. There are 91 other naturally occurring elements, some radioactive. How did they get here?

Claims that those 91 elements formed inside stars are probably not correct, even if one accepts the big bang theory and ignores its many problems. We only know how the lightest 26 elements *might be* produced in stars. (Fusion—forming heavier elements by squeezing lighter elements together—cannot be sustained inside stars to produce the 68 heaviest elements.) For example, how did uranium, the 92nd heaviest element, form? Most physicists recognize the problem.³³ As astrophysicist, James Lattimer said,

*One of the universe's overriding mysteries is where heavy elements originate.*³⁴

Nonscientists usually say that heavy elements formed when stars exploded as supernovas, but that is incorrect. It overlooks the special energy requirements for fusion, and the need for a vast production of neutrons.³⁵ (Such a production process has never been observed.) Obviously, gigantic explosions are much more likely to scatter the lighter elements than to force them together, and the powerful electrical forces that oppose the merging of atomic nuclei become even stronger as nuclei become heavier. Finally, as explained in **“Star Births? Stellar Evolution?”** on page 34, stars would not form after a big bang.

So what is the origin of Earth's radioactivity? It is a consequence of the global flood. [For details, see pages 379–433.] I suggest you first examine all other chapters in Part II. Then, if you study the more difficult radioactivity chapter, you will receive three bonuses: an awareness of (1) the power of the flood, (2) the staggering amount of nuclear energy released, and (3) the scientific errors made by those claiming that radioactive dating shows the Earth is billions of years old.

Details and evidence will be given later in this chapter.

Layered Fossils. Fossils rarely form today, because dead plants and animals decay before they are buried in enough sediments to preserve their shapes. Nor do we see fossils forming in layered strata that can be traced over thousands of square miles. How, then, did so many fossils form? It will soon become apparent why animals and plants were trapped and buried in tens of millions of cubic miles of sediments that were quickly cemented to form the fossil record and why fossils of sea life are found on every major mountain range.

Changing Tilt of Earth's Axis. George F. Dodwell served as the Government Astronomer for South Australia from 1909 to 1952. In the mid-1930s, he became interested in past changes in the tilt of the Earth's axis. He collected almost 100 astronomical measurements made over a 4,000-year period. Those measurements show that the tilt of the Earth's axis smoothly decayed from 25°10' to its present value of 23°27'. Based on the shape of the decay curve, Dodwell estimated that this axis shift began recently.³⁶

The gravitational forces of the Sun, Moon, and planets do change the tilt of the Earth's axis, but much more slowly than the changes Dodwell measured. An extraterrestrial body striking the Earth would provide an abrupt change in axis orientation, not the smooth changes Dodwell measured. Also, only a massive and fast asteroid striking the Earth at a favorable angle would tilt the axis that much. However, the resulting pressure pulse would pass through the entire atmosphere and quickly kill most air-breathing animals—a recent extinction without evidence.

Comets, Asteroids, and Meteorites. These strange bodies, sometimes called “the mavericks of the solar system,” have several remarkable similarities with planet Earth. They contain considerable water. (About 38% of the mass of comet Tempel 1 is frozen water.³⁷) Water is rare in the universe, but both common and concentrated on Earth—often called “the water planet.” Most of the remaining mass of a comet is dust, primarily the crystalline mineral olivine. Solid material that formed in space would not be crystalline. Olivine may be the most abundant of the more than 2,500 known minerals in Earth's crust and mantle. Asteroids and meteorites are similar in many ways to Earth rocks. Surprisingly, a few meteorites contain salt crystals, liquid water, and living bacteria!³⁸ Some asteroids have a chemical substance (kerogen) found in plants.

Earth's Radioactivity. Few people realize that the origin of Earth's radioactivity and the heavier chemical elements have never been explained.³³ Furthermore, radiometric dating assumes that radioactive decay rates have always been constant. A careful understanding of the flood will show how and why Earth acquired its heaviest chemical elements and radioactive materials, and why the “constant rate” assumption (and, therefore, radiometric dating) is grossly in error. This understanding will also show (1) just how powerful the fountains of the great deep were and (2) how the flood destroyed the Earth in ways that are still being felt.

Summary. These are a few of the mysteries associated with the 25 topics listed on page 111. The hydroplate theory will explain these mysteries and tie together the causes and effects of this dramatic, global catastrophe.

How to Evaluate Theories

To explain scientifically an unobserved, unrepeatable event, we must first assume the conditions existing before

that event. From these assumed starting conditions, we then try to determine what should happen according to the laws of physics. Three criteria should be used to evaluate the proposed explanation.

Criterion 1: Process. If we can explain all relevant observations better than any other proposed explanation, confidence in our explanation increases. However, if these starting conditions and the operation of physical laws (or known processes) should have produced results that are not present, then confidence in our explanation decreases.

For example, a frequent and intriguing question is, “What caused the extinction of the dinosaurs?” (We will not answer that question now, but will use it to show how to evaluate scientific theories attempting to explain unobserved and unrepeatable events.) Some dinosaur extinction theories assume large climatic changes. While many types of climate variation might kill all dinosaurs, we must also (by Criterion 1) look at other consequences of large climatic changes. Flowering plants and many small animals are more vulnerable to large climatic changes than dinosaurs. Because most plants and animals did not become extinct with the dinosaurs, “climatic change” theories for dinosaur extinctions are weakened.

Criterion 2: Parsimony. (*Parsimony* here means “the use of few assumptions.”) If a few assumptions allow us to explain many things, then confidence in the explanation will be great. Conversely, if many assumptions are used to explain a few observations, or if we must continually add new assumptions or modify our proposed theory as new observations are made, then we should have little confidence in the explanation.

For example, some say that a large asteroid or comet struck the Earth and killed all the dinosaurs. Supposedly, the asteroid or comet, containing the rare element iridium, kicked up a worldwide dust cloud that blocked sunlight for several years, reduced photosynthesis on Earth, and choked off the dinosaurs’ food chain. Support for this theory comes from layers of clay, containing iridium, in Europe, New Zealand, and elsewhere. Iridium-rich layers sometimes contain dinosaur fossils and, based on evolutionary assumptions, are about 65-million years old.

This one starting condition (an impact of a large asteroid or comet) explains two important observations: dinosaur extinctions and iridium layers. This is good. But there are some hidden assumptions. While most meteorites contain iridium, it has not been detected in asteroids or comets. So, advocates of the impact theory must assume that asteroids or comets have large amounts of iridium (or that meteorites came from comets or asteroids). Other iridium-rich layers have since been discovered too far above *and below* the layer thought to mark the extinction of the dinosaurs. Further studies have found few iridium-rich layers near known impact craters.

(Scientists have recently learned that airborne particles expelled by volcanoes also contain considerable iridium.)³⁹

Also, many marine plants require daily sunlight.⁴⁰ How could they have survived a global dust cloud that killed the dinosaurs? Each problem might be solved by adding new assumptions. However, by Criterion 2, this lowers our confidence in the theory.

Criterion 3: Prediction. A legitimate theory allows us to predict unusual things we should soon see if we look in the right places and make the right measurements. Verified predictions will greatly increase our confidence in an explanation. *Published predictions are the most important test of any scientific theory.* Few evolutionists make predictions that can be tested within a thousand years.

What predictions can be made based on the “climatic variation” and “impact” theories? Few, if any, have been made publicly. This does not inspire confidence in these explanations. Rarely do predictions accompany explanations of ancient, unobserved events. But the impact theory can make some predictions. For example, a very large impact crater should be found whose age corresponds to the time of the extinction of the dinosaurs. Fossils of many forms of life should be concentrated near the crater or, at least, in the hemisphere containing the crater. However, dinosaur fossils are *uniformly* distributed worldwide,⁴¹ a point worth remembering.

For several years, no suitable crater could be found.⁴² Finally, in 1990, an impact site was proposed on Mexico’s Yucatán Peninsula, centered near the village of Chicxulub (CHICK-shoo-loob). Evolutionists initially dated the site as 40–50-million years *before* dinosaurs became extinct. No crater shape was visible, but a buried crater was claimed based on slightly circular magnetic and gravitational patterns, some imagination, and a desire to explain dinosaur extinctions. Impact advocates then redated the region and, in effect, predicted that drilling in and around Chicxulub would reveal an iridium layer and a buried impact crater. Controversy still rages as to whether a crater is present.⁴³

Other dinosaur extinction theories have even more problems. Our purpose in this section is not to settle this issue but to show how scientific reasoning should be applied to unobserved, nonreproducible events. Incidentally, another theory on dinosaur extinction will soon become obvious—a theory involving a global flood and the harsh conditions afterward. [For more on dinosaurs, see “**What about the Dinosaurs?**” on page 493.]

Scientific explanations are never certain or final, and the overused word “prove” is never justified except possibly in mathematics or a court of law. Science is even less certain when dealing with ancient, unrepeatable events, because other starting conditions might work as well or better than the proposed starting conditions. Maybe we have overlooked a physical consequence or have improperly

Figure 55: Cross Section of the Preflood Earth. (Not to scale.) Several aspects of the early Earth are shown here. The thickness of the subterranean chamber varied, because the chamber's granite roof sagged and pressed against the chamber floor at locations that will be called *pillars*. Pillars partially supported the roof. (The confined, high-pressure subterranean water provided most of the support.) Unlike cylindrical pillars we see in buildings, the subterranean pillars were tapered downward. [Pages 469–475 explain how, why, and when pillars formed.]

Supercritical water (SCW) in the subterranean chamber dissolved certain minerals in the chamber's floor and ceiling—giving that rock a porous, spongelike texture. [SCW is explained on pages 126–127.] High-pressure water filled those voids. The Moho, defined as the sudden transition between slow and fast seismic waves, lies about 3 miles below the chamber floor and marks the bottom of that porous, water-filled layer. This is why seismic waves travel more slowly immediately above

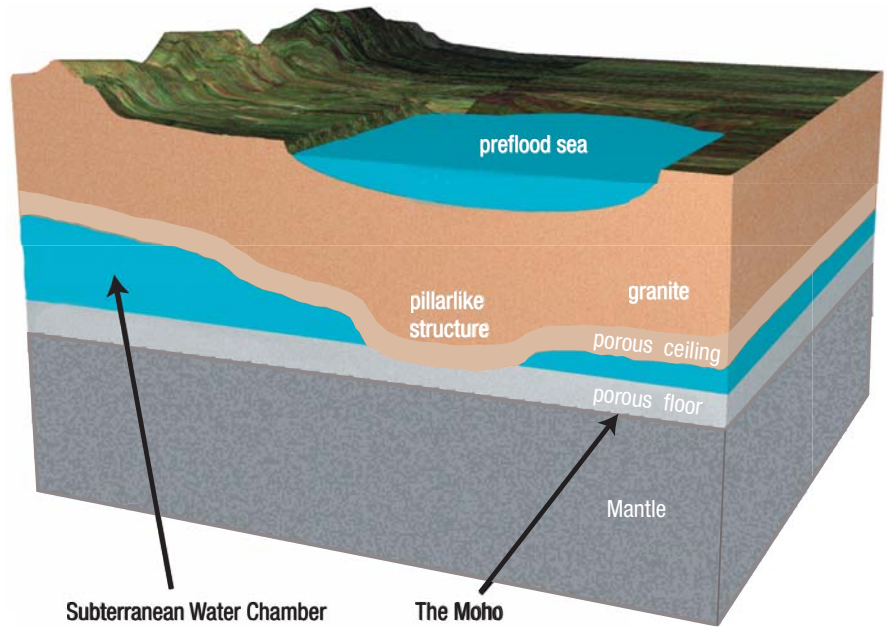

Quartz was one of the first minerals to dissolve. This opened tiny grain-size pockets totaling 27% of the volume of granite. Other minerals undoubtedly also dissolved, so the chamber floor and ceiling would have looked like rigid sponges—each a few miles thick. [An interesting ancient writing mentions this. See the quote from *The Book of the Cave of Treasures* on page 471.] Trapped SCW that filled these tiny pockets remains today. In fact, in 2008, SCW was discovered two miles under the Atlantic floor. Scientists were shocked at finding the first naturally occurring SCW.⁴⁴ This vast, steady source of superhot water, thick with dissolved minerals, the rare isotope of helium (^3He)⁴⁵, and sometimes hydrocarbons⁴⁶, is jetting up through the ocean floors as *black smokers*. [See Figure 56.]

When the flood began, these pockets, a few miles above and below the subterranean chamber, contained much water. To escape to the Earth's surface after the flood, that water had to traverse microscopic, tortuous paths through compressed rock—a very slow process even for a gas or SCW. Black smokers we see today show that small amounts of the subterranean water are still escaping from what was the floor of the subterranean chamber.

applied the laws of physics. Certainly, we can never consider all possibilities or have all the data.

So, to try to scientifically understand unobservable, unrepeatable events, we must consider many sets of starting conditions, estimate their consequences based on physical laws, and then see how well those consequences meet the above three criteria. Ancient records, such as legends or the Mosaic account in the Bible, do not give *scientific* support for the truth or falsity of an ancient event. Such records may provide important *historical* support to people with confidence in a particular ancient record. This, however, is not science. Here in Part II, we will focus on science.

The Hydroplate Theory: Key Assumptions

Starting assumptions, as explained above, are always required to explain ancient, unrepeatable events. The hydroplate theory has one major and two minor starting assumptions. All else follows from them and the laws of physics. Proposed explanations for past events always have some initial conditions. Usually they are not mentioned.

Major Assumption: Subterranean Water. About half the water now in the oceans was once in interconnected chambers, 60 miles below the entire Earth's surface. At thousands of locations, the chamber's sagging ceiling pressed against the chamber's floor. These solid contacts will be called

pillars. The average thickness of the subterranean water was *at least* 1 mile. Above the subterranean water was a granite crust; beneath that water was EARTH's mantle. [See Figure 55.]

Minor Assumption 1: A Global Continent. The Earth's preflood crust encircled the globe. On the crust were deep and shallow seas, and mountains, generally smaller than those of today, but some perhaps 5,000 feet high.

Minor Assumption 2: An Initial Crack. A small initial crack occurred in the Earth's crust. (Several ways this crack could have started will soon be mentioned.) Once a tension crack formed, the high pressures in the chamber and the stress concentrations at each end of the crack would have quickly propagated the crack around the Earth in a great-circle path.

Why does the Mid-Oceanic Ridge also encircle the Earth a great-circle path? The violently escaping subterranean water widened the crack, which removed weight from the chamber floor below. That allowed the chamber floor to bulge upward and form the Mid-Oceanic Ridge. Thus the Mid-Oceanic Ridge also follows a great-circle path.

All 25 major mysteries described earlier, such as major mountain ranges, ice ages, comets, and the Grand Canyon, are consequences of these assumptions. The chain of events that flows naturally from these starting conditions will now be described as an observer might relate those events. The events fall into four phases.

Figure 56: Black Smoker. Black smokers, some as hot as 867°F (464°C), were discovered in 1977 jetting up on a portion of the Mid-Oceanic Ridge in the Pacific. Many other black smokers have since been found along the entire, globe-encircling Mid-Oceanic Ridge, even inside the Arctic Circle and near Antarctica. As hot supercritical water (SCW)⁴⁴ [explained on pages 126–127], from deep under the ocean floor, shoots up into the frigid ocean, dissolved minerals (and on rare occasions, *asphalt*) precipitate out, giving the smoker its black color. SCW can hold vast volumes of dissolved minerals, such as copper, iron, zinc, sulfur, and sometimes hydrocarbons.⁴⁶ SCW has been produced by man in strong, *closed containers*, but never before has SCW been seen in its natural state, even around volcanoes.

How do evolutionary geologists explain black smokers? They say water seeps down several miles below the ocean floor where it is heated by magma to these incredible temperatures and forced it back up through the floor. This could not happen, because SCW can only form in closed containers. Besides, water could not seep downward against a powerful pressure gradient. Uncontained liquid water, heated while slowly seeping downward, would expand, rise, and cool, long before it became supercritical.) If the evolutionary explanation were true, the surface of the magma body would quickly cool, form a crust, and soon be unable to transfer much heat to the circulating water. (This is why we can walk over lava days after a crust forms. The crust insulates us from the hot lava below.) Obviously, black smokers could not be millions of years old, because they are venting so much (1) heat, and (2) water from a finite reservoir below. However, black smokers must have been active for decades, because large ecosystems (composed of complex life forms, such as clams and giant tubeworms) have had time to become established around the base of smokers. Figure 55 explains the origin of black smokers.

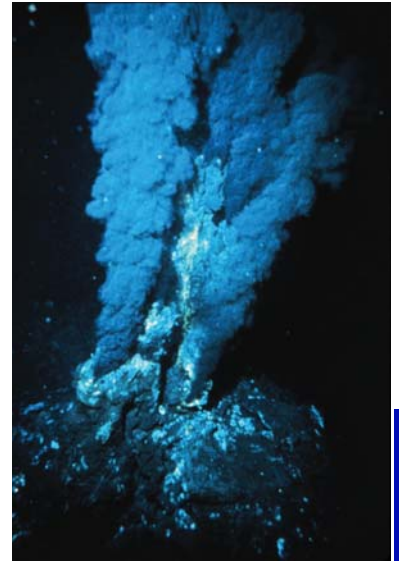

Phases of the Hydroplate Theory: Rupture, Flood, Drift, and Recovery

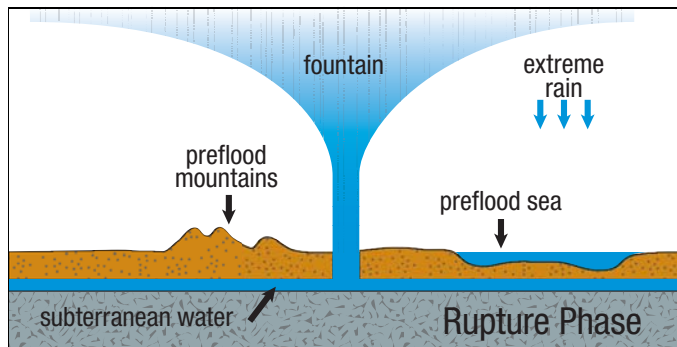

Figure 57: Rupture Phase of the Flood. This 46,000-mile-long rupture encircled the Earth near what is now the Mid-Oceanic Ridge.



Figure 58: Jetting Fountains. For a global perspective of what this may have looked like, see page 108.

Rupture Phase. Centuries of tidal pumping (explained on page 126 and pages 595–596) in the subterranean chamber steadily increased its temperature and pressure. The subterranean water soon became supercritical, as

explained on pages 126–127. Increasing heat losses in the chamber eventually balanced the constant heat input by tidal pumping, so temperatures (and pressure) no longer increased. The overlying crust was stretched, just as a balloon is stretched by internal pressure.

The rupture began with a deep crack at the Earth's surface. Because stresses in tension cracks are concentrated at each end of the crack, both ends grew rapidly—at about 3 miles per second.⁴⁷ Within seconds, this crack penetrated down to the subterranean chamber and then followed the path of least resistance. The rupture probably completed its path around the Earth in about 2 hours.⁴⁸ Initial stresses were largely relieved when one end of the crack ran into the path left by the other end. In other words, the crack traveled a path that intersected itself at a large angle, forming a “T” on the opposite side of the Earth from where the rupture began. That “T” can be seen inside the circle in Figure 44 on page 112.

As the crack raced around the Earth along a great-circle path, the 60-mile-thick crust opened like a rip in a tightly stretched cloth. Pressure in the subterranean chamber directly beneath the rupture suddenly dropped to nearly atmospheric pressure. This caused supercritical water to explode with great violence out of the 60-mile-deep “slit” that wrapped around the Earth like the seam of a baseball.

All along this globe-circling rupture, whose path approximates today's Mid-Oceanic Ridge,⁴⁹ a fountain of water jetted hypersonically into *and far above* the atmosphere. Some of the water fragmented into an “ocean” of droplets that fell as torrential rain great distances away. This produced rains such as the Earth has never experienced—before or after.

Other jetting water rose above the atmosphere, where it froze and then fell on various regions of the Earth as huge masses of extremely cold, muddy “hail.” That hail buried, suffocated, and froze many animals, including some

Three Common Questions

Those not familiar with the behavior of high-pressure fluids sometimes raise three questions.

1. How could rock float on water? The crust did not float on water; water was trapped and sealed under the crust. (Water pressure and contact points (called *pillars*) between the chamber's sagging ceiling and the chamber floor supported the crust.) The crust was like a thin, dense slab of rock resting on and covering an entire waterbed. As long as the waterbed mattress does not rupture, the dense slab will rest on top of less-dense water. Unlike a waterbed's seal, which is only a thin sheet of rubber, the chamber's seal was compressed rock about 60-miles thick. Pressures 5 miles or more below the Earth's surface are so great that rock deforms like highly compressed, extremely stiff putty.²⁰ Therefore, the slightest tension crack could not open *from below*.

2. Temperatures increase with depth inside the Earth. Subterranean water about 60 miles below the Earth's surface would have been extremely hot. Wouldn't all life on Earth have been scalded if that water flooded the Earth?

No. Today's geothermal heat is a result of the flood. Let's first understand *tidal pumping* that continually heated the *supercritical* subterranean water (SCW) —a very high-energy, explosive form of water discovered in 1822.⁵⁰ (Besides, the expanding fountains of the great deep became very cold. [See “**Rocket Science**” on pages 581–582.]

Tidal Pumping.⁵¹ Tides in the subterranean water lifted and lowered the massive crust twice daily, stretching and compressing the pillars, thereby generating heat and raising the temperature of the subterranean-water. As quartz and certain other minerals dissolved, this hot, high-pressure water increasingly contained the ingredients that would later produce limestone (CaCO₃), salt (NaCl), other forms of quartz (SiO₂). In a few chapters, you will see why, after the flood, this dissolved quartz petrified some wood and cemented loose flood sediments into sedimentary rocks.

SCW. At a pressure of one atmosphere—about 1.01 bar or 14.7 psi (pounds per square inch)—water boils at a temperature slightly above 212°F (100°C). As pressure increases, the boiling point rises. At a pressure of 3,200 psi (220.6 bars) the boiling temperature is 705°F (374°C). **Above this pressure-temperature combination, called the critical point, water is supercritical and cannot boil! Nor will any amount of pressure liquefy the water vapor!**

The pressure in the 60-mile-deep subterranean chamber, simply due to the weight of the crust, was about 372,000 psi (25,550 bars)—far above the critical pressure. As the denser and thicker portions of the crust sagged in places and settled to the chamber floor, it lost potential energy which was gained as heat by the subterranean water. That water then became supercritical, exceeding 705°F and to a degree ionized.⁵² [See Figures 240-241 on pages 476-477.]

SCW can dissolve much more salt (NaCl) per unit volume than normal water—up to 840°F (450°C). At higher temperatures, all salt precipitates (**out-salts**).⁵³ In a few pages, this fact will show why our oceans have so much salt, and how salt domes formed.

SCW consists of microscopic liquid droplets dispersed within very dense water vapor. Hot droplets cool primarily by evaporation from their surfaces.⁵⁴ The cooling rate is proportional to their total surface area. The smaller a droplet, the larger its surface area is relative to its volume, so more of its heat can be quickly transferred to its surroundings. Liquid droplets in SCW have an area-to-volume ratio that is **a trillion (10¹²) times greater** than that of the flood water that covered the Earth's surface. Consequently, the liquid in SCW cools almost instantly if its pressure drops, because the myriad of shimmering liquid droplets, each surrounded by vapor, can simultaneously evaporate.⁵⁵ A typical SCW droplet at 300 bars and 716°F (380°C) consists of 5–10 molecules. These droplets evaporate, break up, and reform rapidly and continually.⁵⁶

This explains how the escaping supercritical *liquid* transferred its energy into supercritical *vapor*. How did the vapor lose its energy and cool? **Rapid expansion.** A remarkable characteristic of supercritical fluids is that a small decrease in pressure produces a gigantic increase in volume—and cooling.⁵⁷ So, as the SCW flowed toward the base of the rupture, its pressure dropped and the vapor portion expanded and cooled to an extreme extent. [See “**Rocket Science**” on page 581.] As it expanded, it pushed on the surrounding fluid (gas and liquid), giving all fluid downstream *ever increasing kinetic energy*.

As the horizontally flowing liquid-gas mixture began to flow upward through the rupture, the pressure steadily dropped in each bundle of supercritical fluid. This released its electrical ionization energy, and some of each liquid droplet evaporated to become vapor. Within seconds, portions of the flow rose above the atmosphere where the pressure was almost zero. This 10,000-fold expansion was a weeks-long, focused explosion of indescribable magnitude—“splitting” the atmosphere and accelerating much of the water, along with rock and dirt, into the vacuum of space.⁵⁸

In summary, as the flood began, SCW jetted up through a globe-encircling rupture in the crust—as from a ruptured pressure cooker. This huge acceleration expanded the spacing between water molecules, allowing flash evaporation, sudden and extreme cooling, followed by even greater expansion, acceleration, and cooling. Therefore, most of the vast thermal, electrical, chemical, and surface energy⁵⁹ in the subterranean water ended up *not as heat at the Earth's surface but as extreme kinetic energy in all the fountains of the great deep*. As you will see, these velocities were high enough to launch rocks into outer space—the final dumping ground for most of the energy in the SCW.

3. What happens as a fluid becomes supercritical?

Key Experiments. In 1822, French Baron Cagniard de la Tour performed a famous experiment.⁵⁰ A specific amount of liquid was sealed inside a strong glass tube. The meniscus (the boundary between the liquid below and the vapor above) was visible. As the tube was heated, some liquid evaporated. Therefore, the pressure inside the tube and the vapor's low density steadily increased, but as temperatures rose, the liquid's higher density slowly decreased. When the two densities became equal—at a specific temperature and pressure, now called the *critical point*—the meniscus disappeared! Was the substance a liquid, a vapor, or something else? For almost two centuries, no one knew.⁶⁰

In 2005, the results of sophisticated experiments on supercritical water were published. That work by scientists in Germany, France, Sweden, the Netherlands, and the United States showed that both liquid and vapor were present. The liquid consisted of microscopic droplets dispersed—actually floating—throughout the dense vapor.⁵⁶

A Thought Experiment. What follows is conjecture. To my knowledge, no one has described the microscopic behavior of supercritical fluids (SCFs) as I will below, but based on the 2005 experiments, the physics now seems clear. If we could view the meniscus in microscopic detail as the temperature approached the critical point, I believe we would see the following:

The liquid below the meniscus becomes increasingly agitated and resembles a choppy lake on a windy day. The liquid and vapor are nearly in equilibrium, so about as many molecules evaporate from the liquid as enter the liquid from the vapor. At these very high temperatures, vapor molecules strike the liquid surface at a furious rate and splash droplets of liquid up into the dense vapor. As the vapor's density approaches the liquid's density, *the droplets float in the vapor!* This process continues until all liquid below the meniscus is dispersed as microscopic droplets in the vapor, so the meniscus suddenly disappears. The shimmering droplets, suspended in the vapor, are then bombarded from all directions by vapor molecules acting as bullets. When these “bullets” strike a droplet, they either fragment the droplet, stick to it, or bounce off the droplet. Droplets quickly fragment, merge, or evaporate.⁶¹

Would these microscopic droplets float to the top of the vapor? No, but let's assume they did. It would mean that the vapor was denser than the liquid droplets. Vapor molecules would be closer to each other, on average, than liquid molecules. Therefore, vapor molecules would frequently bond with each other and become liquid droplets. The presence of liquid droplets *throughout* the supercritical vapor contradicts our assumption that all the liquid had floated to the top of the vapor. With a little thought, it should become clear that liquid droplets almost instantly

form and disappear within the dense vapor. With water (H_2O), the molecules when fragmented (ionized) become electrically charged particles: H^+ and OH^- .⁵²

As temperatures rise, the vapor molecules travel faster and fragment more droplets. The droplets become, on average, even smaller.⁶² They also collide and merge more frequently, so at each new temperature, an equilibrium is quickly reached between droplets forming and disappearing.

Energy is expended in fragmenting droplets, because work must be done in stretching and breaking molecular bonds in the liquid phase. Most of the energy expended in fragmenting molecules becomes ionization (electrical) energy. If the pressure drops, electrical energy is recovered and surface energy is given up, so the volume expands rapidly and enormously. The faster the pressure drops, the more explosive—and cooler—the expansion.

When the flood began, the pressure in the jetting SCW dropped in seconds from at least 372,000 psi (25,620 bars) to almost zero above the atmosphere. (In a later chapter, you will see how nuclear reactions significantly increased this pressure during the early days of the flood.) The energy released was huge. Because the 46,000-mile-long fountains continued this release for several weeks, one should not think of it as a single explosion. Instead, the jetting water was a powerful, Earth-size nuclear engine that launched considerable mass from Earth.

Great Solubility. Today, SCFs (usually water or carbon dioxide) are studied primarily because of their great dissolving power. In 1879, J. B. Hannay and J. Hogarth first demonstrated this. When they rapidly dropped the pressure in a SCF, the dissolved material precipitated as “falling snow.”⁶³ Why is the solubility of SCFs so great, and why did the solute precipitate so rapidly?

Supercritical liquid droplets impacting solids (like a dense spray of bullets, each slightly larger than a gas molecule) will penetrate, break up, and dissolve more of the solids than will pure liquids.⁶⁴ Also, as described above, the liquid droplets almost instantaneously form and evaporate. When they evaporate, the dissolved solids precipitate (out-salt) as sediments onto a floor. When new droplets form from merging vapor molecules, they contain no solute and can then dissolve more of the solid they encounter. During the flood, the escaping subterranean waters swept most of these loose, precipitated sediments on the chamber floor up to the Earth's surface.

Therefore, supercritical fluids can dissolve large quantities of organic material and certain minerals.⁶⁵ If the pressure in the supercritical fluid suddenly drops, the liquid evaporates explosively and solids precipitates as “snow.” Common precipitates from the subterranean water were limestone ($CaCO_3$), salt ($NaCl$), quartz (SiO_2), and various ores.

A Puzzle Solved

“What drives the super-rotation [on Venus] is a fundamental physics question.”⁶⁶

With our understanding of supercritical fluids (from pages 126-127), puzzles not directly related to the flood are now solved, although they still baffle the experts. We will briefly digress from this study of the flood to see another powerful effect of supercritical fluids.

Why does the upper atmosphere of Venus rotate up to sixty times faster than Venus’ solid surface?

The atmosphere of Venus is 96% carbon dioxide (CO₂) by volume. In the extremely hot, high-pressure lower atmosphere, the CO₂ is supercritical. As the sun begins to heat the day side of Venus, the microscopic droplets floating in the dense, supercritical CO₂ vapor quickly evaporate, expanding and lifting the atmosphere on the day side.

The opposite effect occurs on the night side of Venus. That is, as the night side of Venus radiates its heat into space, supercritical vapor condenses into microscopic supercritical droplets that float within the atmosphere on the night side. This shrinks the atmosphere’s volume on the night side, and creates a standing wave in Venus’ atmosphere—a wave stationary when viewed from the Sun.

Therefore, the height of the atmosphere on the day side, is always higher than on the night side, so the upper atmosphere on Venus, in effect, flows “downhill”—super-rotates at up to 220 miles per hour from the higher day side to the lower night side. [See Prediction 1 below.] As mass shifts from the day to the night side of Venus, pressure on the day side drops slightly, expanding supercritical CO₂ even more and accelerating the process.

The gas-giant planets (Jupiter, Saturn, Uranus, and Neptune) have supercritical interiors—which accounts

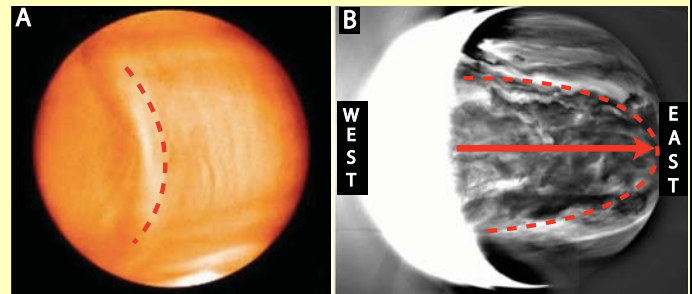

Figure 59: Thermal Images of Venus. In 2016, the Japanese spacecraft Akatsuki took thermal images of Venus. They showed a strange bow shape (highlighted by the dashed red lines) sweeping across the planet for days. The bow “seemed to rotate with Venus’ surface, rather than its much quicker moving atmosphere.”⁶⁸

A: Day (orange), sulfuric-acid clouds (white streaks).

B: Day (white), night (gray). The greatest heating and expansion occurs near Venus’ equator, on the day side, so the upper atmosphere flows in a bow shape that appears as if it were fixed to the terminator (the day-to-night boundary) that rotates with the planet. The parabolic velocity profile extending into the night side resembles that from a powerful fire hose expelling water into an otherwise still lake.

Venus rotates from east to west (opposite to Earth’s rotation), so the Sun rises in the west and sets in the east. The expansion of colder supercritical night-time atmosphere as it rotates into the rising sun, lifts the atmosphere so it flows to the east, in the direction of the red arrow. To conserve angular momentum, there must be a counter thrust that acts to rotate Venus backward. This contributes to Venus’ backward rotation.

for their extremely high wind speeds. (On Jupiter, winds exceed 220 miles per hour (100 meters per second).)



PREDICTION 1: The atmosphere on the day side of Venus will be found to be higher than on the night side. Therefore, a high flow rate occurs in the upper atmosphere from the day side to the night side.

mammoths. [For details, see “Frozen Mammoths” on pages 267–299.] The most powerful jetting water and rock debris escaped Earth’s gravity and became the solar system’s comets, asteroids, and meteoroids. [For details, see “The Origin of Comets” on pages 301–335, and “The Origin of Asteroids, Meteoroids, and Trans-Neptunian Objects” on pages 337–374.] To understand the gigantic energy source that launched this material, one must study “The Origin of Earth’s Radioactivity” on pages 379–433.

Carried up in the fountains were seeds and spores. Those that remained in the atmosphere settled for years after the flood, repopulating the plant kingdom globally.

Flood Phase. Each side of the rupture was initially a 60-mile-high cliff. In the bottom 90% of the cliff face, compressive, vibrating⁶⁷ loads greatly exceeded the rock’s crushing strength, so the bottom 90% continually crumbled, collapsed, and spilled out into the jetting fountains. That

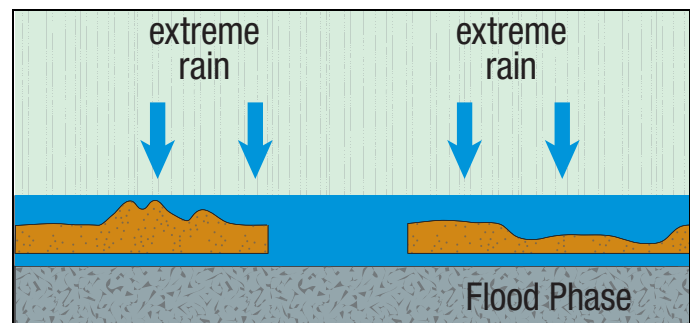

Figure 60: Flood Phase. Sediments in the escaping water increased until their volume nearly equaled the volume of water gushing out. These suspended particles quickly settled and buried plants and animals in a chaotic mixture. During this phase, a phenomenon called *liquefaction* sorted sediments, animals, and plants into uniform horizontal layers that covered vast areas. Traces of these dead organisms are called *fossils*. Global liquefaction is explained on pages 195–213.

Two More Puzzles Solved

Iceland and its many volcanoes straddle the Mid-Atlantic Ridge. Large amounts of supercritical water (SCW) at 840°F have been found in porous rock a mile below Iceland's surface, but scientists, interested in using that SCW as a geothermal source for generating electricity, are puzzled by two issues.⁶⁹

1. They believe the SCW must be heated by conduction from a magma chamber far below. However, just as heat rises rapidly in a chimney, hot water convects up from the base of that SCW much faster than heat from the magma chamber could conduct up through rock. How then could the water's temperature have ever risen—let alone become supercritical?

2. At the high temperatures and pressures required to produce SCW, the flow channels in the porous rock should have already collapsed and not be porous. No convection should occur, but it does.

Based on what you have learned about SCW, especially on pages 126-127 can you resolve these two problems?

Answer: *The water became supercritical by tidal pumping in the preflood subterranean chamber, not by a deep magma chamber. Once the water became supercritical, the more soluble minerals, such as quartz in the chamber's floor and ceiling, dissolved, making that rock porous or spongelike. The subterranean water then filled the hollowed out channels in the chamber's floor and ceiling with high pressure SCW that kept the channels open. Today, some of that SCW is leaking up to the surface of Iceland. Heat does not need to be conducted up into the water; the heat has been in the water since before the flood.*

removed support for the top 10% of the cliff, so it also fragmented and fell into the pulverizing hypersonic flow. The 46,000-mile-long rupture rapidly widened, reaching an average width of about 1,400 miles all around the Earth.

Later, in the chapter, **“The Origin of Earth's Radioactivity”** on pages 379–433, you will see that the water in the spongelike pockets in the crust experienced tremendous heating and expansion that forced that water back into the chambers. Therefore, the hydroplates settled slowly.⁷⁰

Sediments swept up in the escaping flood waters gave the water a thick, muddy consistency. These sediments rapidly settled out over the Earth's surface, burying many plants and animals, forming the fossil record.

The downward sagging edges of the massive hydroplates slowly closed the powerful jetting fountains, but massive

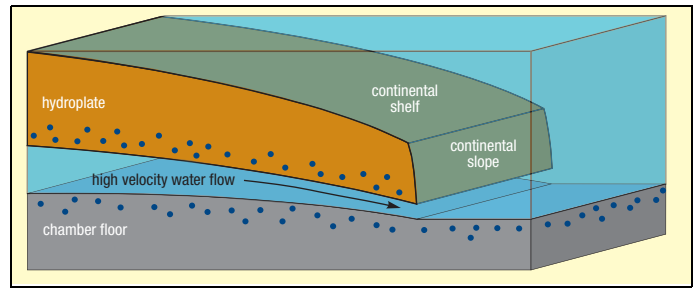

Figure 61: Continental Shelves and Slopes. The escaping SCW expanded and accelerated continuously as it flowed out from under the hydroplates and up through the rupture. Therefore, the plates were increasingly eroded along those paths. (The horizontal flow made the plates thinner toward their edges, and the flow up through the rupture eroded more near the top of each edge.)

Also, the edges of each hydroplate sagged downward, because the pressure below the edges was less than the pressure below the center. This eroded the bottom edges even more. Consequently, after the hydroplates settled onto the chamber floor, continental shelves and slopes existed worldwide.

Before the flood, much of the SCW water in the subterranean chamber had migrated into the spongelike openings (shown as blue dots above) in the chamber's roof and floor. Once the temperatures in the SCW exceeded about 840°F (450°C), its dissolved salt precipitated (*out-salted*, as explained on page 127). Therefore, it should not be surprising that low salinity water is found under the sea floor, but most geologists are surprised.⁸

During the flood, thick layers of sediments blanketed the granite crust, forming aquifers—permeable, sedimentary layers filled with generally salt-free water. Today, some of those aquifers lie below the continental shelf which constitutes part of the sea floor.

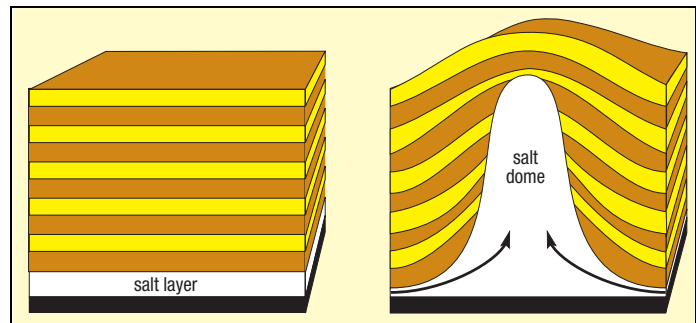

Figure 62: Salt Dome. Just as a cork released at the bottom of a swimming pool will float up through water, wet salt can float up through denser, *freshly deposited* sediments. A salt dome begins to form when a small part of a wet salt layer rises. Other salt in the layer then flows horizontally and up into a rising plume. If the salt is thick and saturated with water, friction offers little resistance, and salt will continue to feed into the rising plume. The upturned (or bowl-shaped) layers next to the salt dome can become traps in which oil collects, so understanding salt domes has great economic value. *Note: If all the sediments in and above the salt layer had not been loose, freshly deposited, and nearly frictionless (saturated with water), there would be no salt dome.*

amounts of water continued to leak out. Because today's major mountains had not yet formed, global flooding covered Earth's relatively smooth topography. As explained on page 126, salt had precipitated out of the supercritical subterranean water before the flood began, covering the chamber floor with solid, but mushy, salt. Escaping water swept much of it out of the chamber.

Figure 63: Upward Buckling. The floor of a limestone quarry buckled upward in Yorkshire, England, in 1887.⁷¹ The explanation is quite simple. Shale, which lay beneath the floor, consists of platelike particles that can slide over each other like playing cards in a deck. The weight of the quarry's walls squeezed shale toward the center of the quarry, increasing the upward pressure on the quarry floor. Once the slightest upward buckling began, the limestone floor weakened, allowing the shale to push up even more.

In the flood cataclysm, the “quarry” was about 60 miles deep, hundreds of miles wide, and 46,000 miles long. The high upward pressure on the “exposed” portion of the subterranean chamber floor was no longer balanced by the weight of the crust pressing down. Therefore, that portion of the chamber floor increasingly bulged upward, as happened in the quarry. Eventually, the hydroplates, still supported by high-pressure water, began to slide downhill, away from the rapidly rising bulge. This removed even more weight from the chamber floor, accelerating its upward bulging. Today, the upbuckled region is the globe-encircling Mid-Oceanic Ridge.

Mechanical and civil engineers call this phenomenon “the buckling of a plate on an elastic foundation.”⁷² I have demonstrated this to hundreds of audiences. Place long bricks on top of a foam mattress that is horizontally compressed in a rigid box. Then, slowly remove the bricks from the foam mattress, beginning at the center and moving outward. When enough bricks are removed, the mattress suddenly springs upward, raising the remaining bricks. If these bricks were on a frictionless surface (such as water), they would accelerate downhill, just as continents (hydroplates) did during the continental-drift phase. When the hydroplates crashed, hours after continental drift began, mountains worldwide were buckled up and wide ocean basins opened up.

Although a void opens up under the upbuckled foam mattress, no void would open deep inside the Earth, because pressures are too great. Consequently, high-pressure rock from below would buckle up to fill the space. That would not leave a void farther down, because even deeper rock would be squeezed up to fill the space. Ultimately, mass from the opposite side of the Earth must depress to compensate for the rising Mid-Atlantic Ridge—and the entire Atlantic floor. Therefore, the Pacific and Indian Oceans rapidly formed. Evidence and details are given on pages 153–192.

When sediments falling through the flood waters blanketed the pasty, low-density salt, an unstable arrangement arose, much like having a layer of light oil beneath a denser layer of water. A slight jiggle of that mixture will cause the lighter layer below to flow up as a plume through the denser layer above. A plume of salt is called a *salt dome*. [See Figure 62.] Deep salt layers—some 20,000 feet below today's sea level³⁰—are resting on what was the much deeper chamber floor. Wherever the chamber roof was blown off, the floor below rose. Two such places are now the Gulf of Mexico and the Mediterranean Sea.

The supercritical water (SCW) in the subterranean chamber had also dissolved minerals containing calcium, carbon, and oxygen. They, too, had precipitated out of the SCW as temperatures rose before the flood, blanketing the chamber floor with limestone (CaCO_3) particles. As the flood waters escaped, these particles were swept out and up onto the Earth's surface. The total volume of limestone on the Earth today is staggering and cannot be explained by processes occurring at the Earth's surface. [See “**The Origin of Limestone**” on pages 260–266.]

Today, on the floor of the Gulf of Mexico, SCW sometimes escapes up through salt domes and precipitates *asphalt (tar)*,

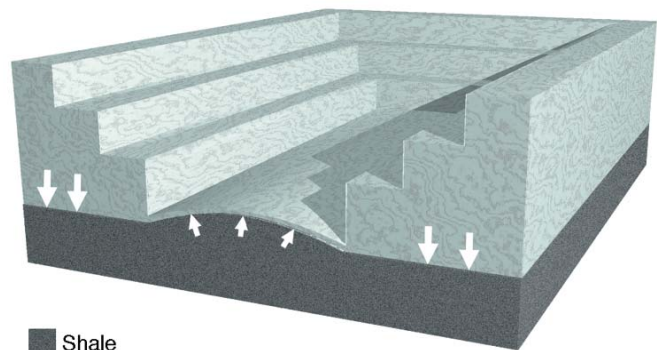

■ Shale
■ Limestone and Marble

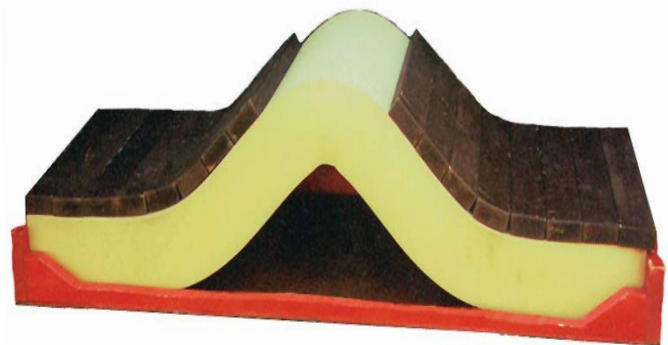

the least volatile component of petroleum.⁴⁶ What is the hydrocarbon source? Obviously, organic material. Recall that black smokers—with their escaping SCW—are usually surrounded by buried vegetation and large ecosystems, such as swarms of giant tubeworms feeding on chemicals dissolved in SCW. That organic material is quickly dissolved by the SCW when the vents shift locations. As the SCW jets up into the cold sea water and cools, hydrocarbons quickly precipitate, paving the seafloor with a tar residue.

Flooding uprooted most of Earth's abundant vegetation and transported it to regions where it accumulated in great masses. [Pages 195–213 explain how this vegetation was collected and sorted into thin layers within the sediments.] Later, at the end of the continental-drift phase, buried layers of vegetation were rapidly compressed and heated, precisely the conditions that laboratory experiments have shown will form coal and oil.⁷³ The flood phase ended with continents near the positions shown in Figure 54 and the top frame of Figure 67.

Continental-Drift Phase. Material within the Earth is compressed by overlying rock. Rock's slight elasticity gives it springlike characteristics.⁷⁴ The deeper the rock, the more weight above, so the more tightly compressed the “spring”—all the way down to the center of the Earth.

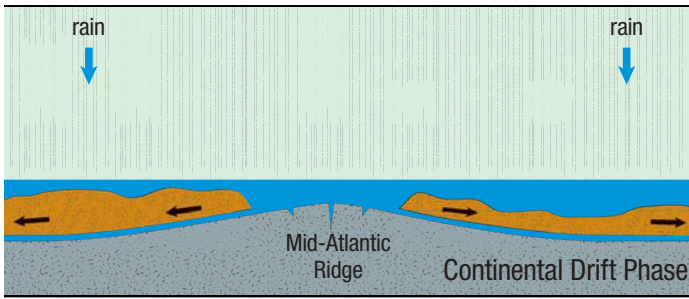

Figure 64: Continental-Drift Phase of the Flood.

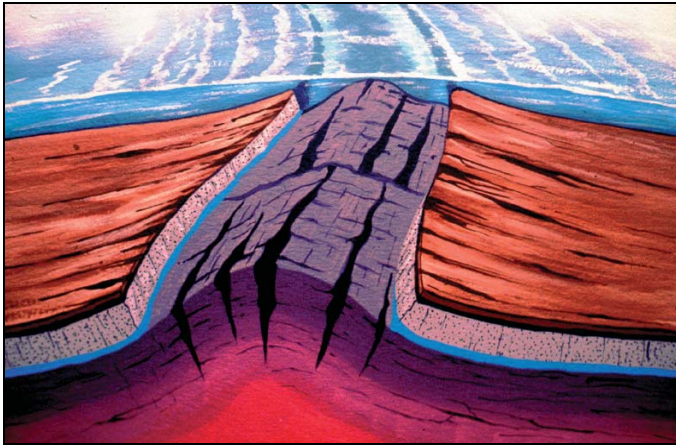

Figure 65: Birth of Mid-Atlantic Ridge and the Ultimate Slippery Slope. Ice is slick, especially if one is on ice skates, because as long as ice is directly under the great pressure of the metal blades, that ice normally turns to liquid water. So ice skaters are actually sliding on liquid water.

Imagine how fast a skater—or a hydroplate—would slide down a mountainside the size of the Mid-Atlantic Ridge, whose surface was *fifty times slicker than liquid water!* Supercritical water (SCW) has a viscosity (frictional resistance) about one-fiftieth that of normal water. SCW provided almost no resistance to the massive sliding hydroplates; it was much like riding on a cushion of air.⁷⁵ Later in this book, we will calculate that speed. If you haven't studied Figure 50 on page 117, the answer will surprise you.

Contrast that with the century-old problem geologists have trying to understand how the rock in massive continental plates can scrape over and through mantle rock, which is a solid, not a liquid. Obviously, the plates cannot. Geologists have a serious problem.

The rupture path steadily widened during the flood phase. [See Figure 66e.] Eventually, the width was so great, and so much of the surface weight had been removed, that the compressed rock beneath the exposed floor of the subterranean chamber sprung upward. [See Figure 66f.]

As the Mid-Atlantic Ridge began to rise, the granite *hydroplates* started to slide downhill on the steepening slopes. This removed even more weight from what was to become the floor of the Atlantic Ocean, so the floor rose faster, the slopes increased, and the hydroplates accelerated, removing even more weight, etc. The entire Atlantic floor rapidly rose about 30 miles. When the first segment of the Mid-Atlantic Ridge began to rise, it helped lift adjacent portions of the chamber floor just enough for them to become unstable and spring upward. This process continued

all along the rupture path, forming the Mid-Oceanic Ridge. Also formed were fracture zones and the ridge's strange offsets at fracture zones.⁷⁶ Soon afterward, magnetic anomalies (Figure 48 on page 115) began to develop.⁷⁷

The sliding hydroplates were almost perfectly lubricated by water still escaping from beneath them. (Remember, the water trapped in spongelike pockets in the chamber floor and ceiling was slowly squeezed out. See Figure 55 on page 124.) This sliding process resembled the following:

A long train sits at one end of a very long, level track. If we could somehow just barely lift the end of the track under the train and the wheels were frictionless, the train would start rolling downhill. Then we could lift the end of the track even higher, causing the train to accelerate more. If this continued, the high-speed train would eventually crash into something. The long train of boxcars would suddenly decelerate, compress, crush, and jackknife."

Continental plates accelerated away from the widening Atlantic. Recall that the rupture encircled the Earth, and the escaping subterranean water widened that rupture to an average of about 1,400 miles—on both the Atlantic and Pacific sides of the Earth. Plates then slid away from the rising Mid-Atlantic Ridge and toward that 1,400-mile-wide gap on the Pacific side of the Earth.⁷⁸ The next chapter will explain why the Pacific floor simultaneously dropped as the Atlantic floor rose, further steepening the downhill slide and removing obstacles to the accelerating hydroplates.

Eventually, the hydroplates ran into resistances of two types. The first happened as the water lubricant beneath each sliding plate was depleted. The second occurred when a plate collided with something. As each massive hydroplate decelerated, it experienced a gigantic *compression event*—buckling, crushing, and thickening each plate, and pushing up major mountain ranges, many with fossils of sea life on top. [See “[Seashells on Mountaintops](#)” on page 49.]

To illustrate this extreme compression, imagine yourself in a car traveling 45 miles per hour. You gently step on the brake as you approach a stop light and brace yourself by straightening and stiffening your arms against the steering wheel. You might feel 15 pounds of compressive force in each arm, similar to what you would feel lifting 15 pounds above your head with each hand. If we repeated this deceleration at the stop light, but each time doubled your weight, the compressive force in your arms would also double. After about six doublings, especially if you were sitting on a lubricated surface, your arm bones would break. If your bones were made of steel, they would break after nine doublings. If your arm bones were one foot in diameter and made of granite, 17 doublings would crush them.

If the decelerating mass was a hydroplate, the compressive forces would increase enough to crush and thicken the hydroplate and push up major mountain chains and create overthrusts in less than an hour. [For details, see “[Can](#)

Spring Analogy

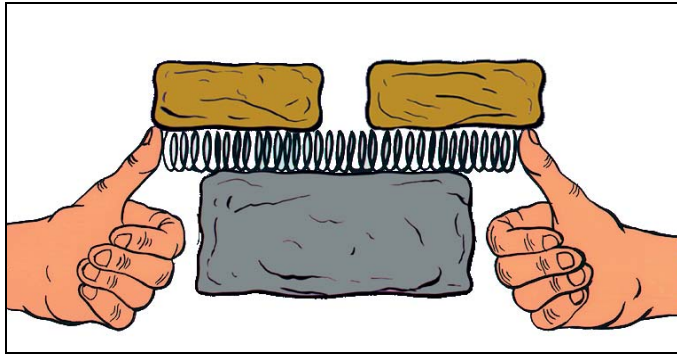

a) Overlying rocks keep a compressed spring horizontal.

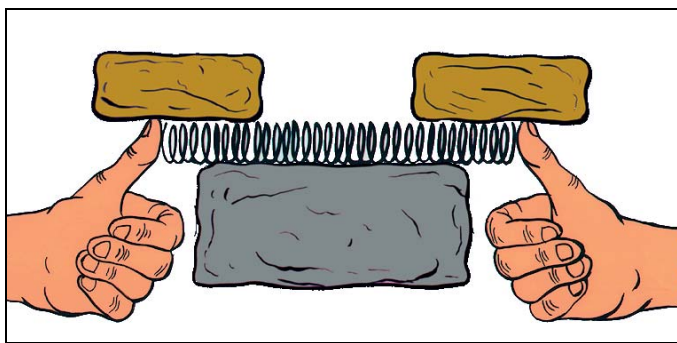

b) The spring remains aligned and compressed as the gap between the rocks widens.

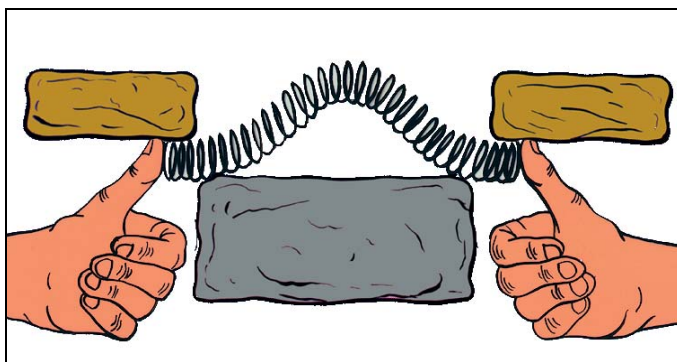

c) When the gap reaches a certain critical width, the spring suddenly buckles upward. Now consider thousands of similar but parallel springs lined up behind the first spring—all linked together and repeating, in unison, steps a–c. The upward buckling of any one spring will cause adjacent springs to become unstable and to also buckle up. They, in turn, will lift the next spring, and so on, in ripple fashion (like falling dominoes), but slowly, because the Mid-Oceanic Ridge is so massive.

Hydroplate Theory

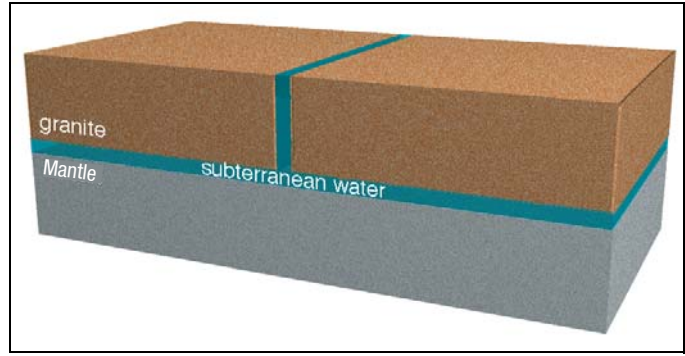

d) Rupture completed. Jetting water not shown.

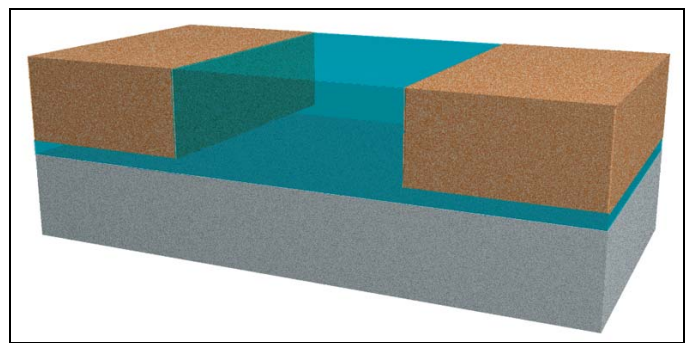

e) The rupture's path widens by the erosion, crumbling,⁷⁹ and collapse of the unsupportable vertical walls, exposing part of the chamber floor. Most of Earth's sediments (tens of millions of cubic miles of sediments) are quickly produced by escaping, high-velocity waters—the fountains of the great deep.

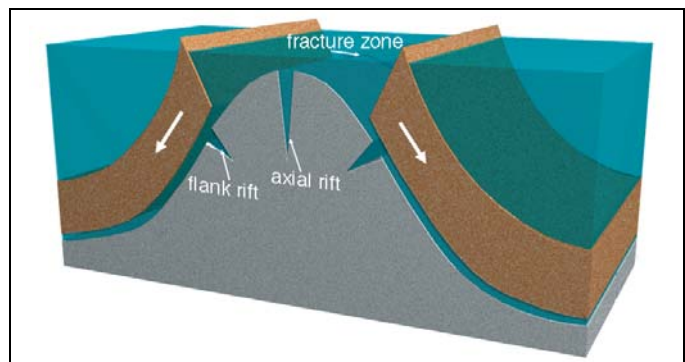

Fracture zones form perpendicular to the ridge axis; rifts form along the ridge axis.⁷⁶ The massive hydroplates, lubricated by water, begin to accelerate downhill. As more and more weight slides away from the newly-formed ridge, the exposed chamber floor quickly rises several miles, accelerating the hydroplates even more, and becomes the Atlantic floor. (In the next chapter, you will see why events in the Pacific greatly steepened the downhill slope and opened up more space for the plates to slide.)

Figure 66: Spring Analogy Showing Development of the Mid-Atlantic Ridge.

Figure 67: Computer Animation of the Continental-Drift Phase. The top frame shows one side of the Earth at the end of the flood phase. Because the rupture encircled the Earth, a similar eroded gap existed between the hydroplates on the other side of the globe. The Mid-Oceanic Ridge rose first in the Atlantic, hours or days before the ends of the rising ridge extended into what is now the Pacific. This caused the hydroplates to accelerate downhill on a layer of lubricating water, away from the widening Atlantic and into the gap on the opposite side of the Earth.

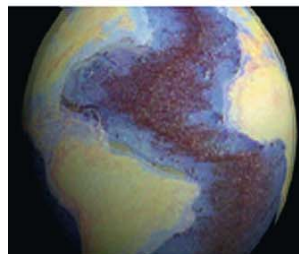
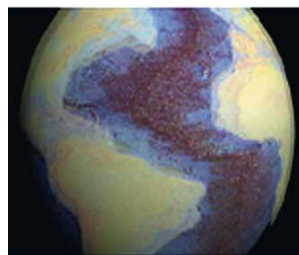
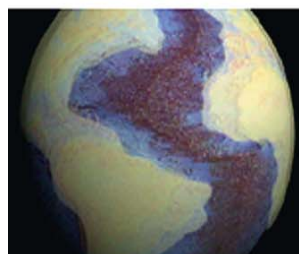
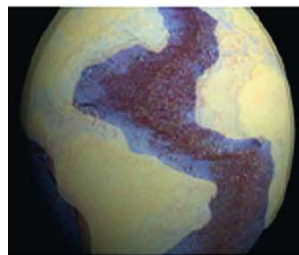
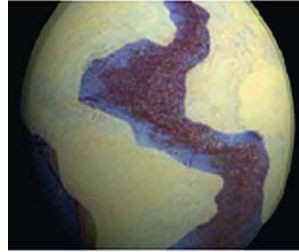
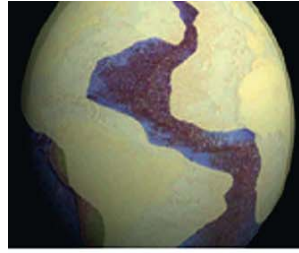

The continental-drift phase ended (bottom frame) with the dramatic *compression event* that squeezed up Earth's major mountain ranges. These six frames simply rotate the present continents about today's polar axis. Therefore, greater movement occurs at lower latitudes. Movement begins from where the continents best fit against today's base of the Mid-Atlantic Ridge (Figure 54 on page 121) and ends near their present locations.

Not shown are other consequences of the compression event. For example, continents were squeezed and thickened, narrowing their widths and widening the Atlantic. Of course, regions where mountains formed thickened the most, but nonmountainous regions thickened as well. Regions that did not thicken are now part of the shallow ocean floor. [See Figure 44 on page 112.]

While it may seem strange to think of squeezing, thickening, and shortening granite, one must understand the gigantic forces required to decelerate sliding continental plates. If compressive forces are great enough, granite deforms, much like putty, on a global scale. On a human scale, however, one would not see smooth, puttylike deformation; instead, one would see and hear blocks of granite fracturing and sliding over each other. Some blocks would be the size of a small state or province, many would be the size of a house, and even more would be the size of a grain of sand. Friction at all sliding surfaces would generate heat. At great depths, this would melt rock. Liquid rock (magma) would squirt up and fill spaces between the blocks. This is seen in most places where basement rocks are exposed, as in the Black Canyon of the Gunnison and the inner gorge of the Grand Canyon (shown on pages 134 and 135).

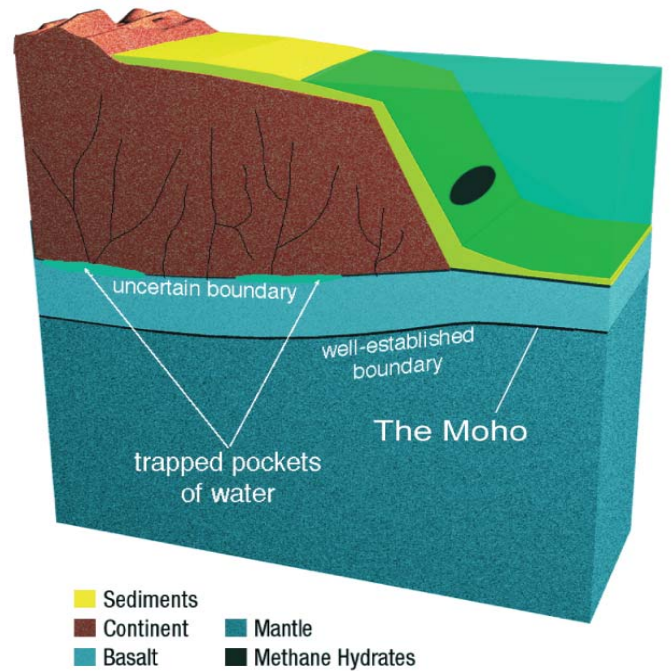

Figure 68: Typical Cross Section of Today's Continents and Oceans. Notice how the Moho is depressed under major mountains and higher under the ocean floor. Although some boundaries are uncertain, most of these general characteristics are well known. Also notice that large pockets of water should be under major mountains.

Overthrusts Occur? Can Strata Fold? Can Mountains Buckle?" on page 204.] Water could then drain off the thickened continents and into the newly opened and very deep ocean basins. For each cubic mile of land that rose out of the flood waters, one cubic mile of flood water drained.

Compressing a long, thin object, such as a yardstick, produces no bending or displacement until the compressive force reaches a certain critical amount. Once this threshold is exceeded, the yardstick (or any long compressed beam or plate) suddenly arches into a bowed position. Further compression bows it up even more. Buckling a hydroplate at one point also bends adjacent portions.

Therefore, mountain chains were pushed up by the *crushing* of hydroplates. Where the compression exceeded the crushing strength of granite, the plate thickened and shortened. The collapse of strength in the crushed region increased the load on adjacent regions, causing them to crush and the mountain chain to lengthen. Therefore, bending and crushing rapidly lifted mountain ranges. Naturally, the long axis of each buckled mountain was generally perpendicular to its hydroplate's motion—that is, parallel to the portion of the Mid-Oceanic Ridge from which it slid. So, the Rockies, Appalachians, and Andes have a north-south orientation. (Later sections of this book will explain why, in the years after the flood, melting deep inside the Earth produced the Earth's core and further vertical changes at the Earth's surface.) The forces acting during this dramatic event were not applied to stationary

A Picture with a Story

Here at the Black Canyon of the Gunnison in Colorado, cliffs are exposed for up to 2,700 feet above the Gunnison River. Their marble-cake appearance comes from melted rock, primarily quartz, that was forced up through cracks in the darker rock.⁸⁰ To appreciate the size of this cliff, notice the trees, 10–15 feet tall, at the top of the cliff.

Now, let's put aside all prior opinions and ask, "What caused this marble-cake pattern?" First, deep magma must be present or be produced.

Second, the black rock must be fractured. This obviously takes gigantic forces acting over a large area, but the forces must be of a special kind. A tensile (stretching) force would produce one crack, or at most a few evenly-spaced cracks. At the instant of breakage, the pieces would scatter. (Try breaking something by pulling on it. When it breaks, the pieces will fly apart.) This leaves us with only one viable type of force—compression.⁸¹

If compressive forces acted equally in all directions, no breaks would occur. For example, deep sea creatures, living under high compressive pressure (inside and out), are not crushed. Also not crushed are many delicate pieces of pottery found in sunken vessels on the ocean floor. [See the technical note, "**Highly Compressed Solids**," on page 608.]



Figure 69: Black Canyon of the Gunnison.

If compressive forces acted slowly but were almost evenly balanced, slight but slow movements would occur at the molecular level, a phenomenon called *creep*. The rock would slowly flow like putty, until the forces balanced.

Some channels (or cracks) are wider than others. Normally, the largest channels provide the least flow resistance, so all magma from below should have spilled out through them. (Pump a liquid into a closed container until it cracks. You will see only one or at most a few major cracks, not many little cracks.) If the magma had been in a chamber below, just waiting for a crack to appear, the first crack should release all the magma, unless it solidified on its way up through the colder rock.

(static) continents resting on other rocks. The forces were dynamic, produced by rapidly decelerating hydroplates riding on lubricating water that had not yet escaped.

As mountains buckled upward, water remaining under the plates tended to fill the voids formed. Some pooled water should still be in cracked and contorted layers of rock under mountains. [See Figures 68 and 71.] This partially explains the reduced mass beneath mountains that gravity measurements have shown for over a century.⁸²



PREDICTION 3: Salty water frequently fills cracks in granite, 5-10 miles below the Earth's surface (where surface water should not be able to penetrate).

(Note: Each of the 58 predictions in this book is marked by an icon at the left representing Figure 42 on page 108.)

Friction at the base of skidding hydroplates and below sinking mountains generated immense heat, enough to melt rock. Crushing produced similar effects, as broken and extremely compressed blocks and particles slid past each other. The deeper the sliding, the greater the pressure pushing the sliding surfaces together, so the greater the frictional heat generated. Where heat was most intense, large volumes of rock melted. High-pressure magma squirted up through cracks between broken blocks. Sometimes magma escaped to the Earth's surface, producing volcanic activity and "floods" of lava outpourings, called *flood basalts*, as seen on the Pacific floor and the Columbia

PREDICTION 2: Beneath major mountains are large volumes of pooled saltwater. (Recent discoveries support this prediction, first published in 1980. Supercritical saltwater appears to be below the Tibetan Plateau, which is bounded on the south by the largest mountain range on Earth.)⁸³



But if all cracks formed simultaneously, then magma would fill most cracks. All this leaves us with one conclusion for how the fractures occurred—**rapid crushing**.

Next, magma must rapidly squirt up through the cracks in the black rock. If it happened slowly, or even at the rate a river flows, the front edge of the upward-flowing magma would solidify (freeze), stopping the flow. If water is dissolved in any molten rock, its melting temperature is lowered considerably. Therefore, melted quartz *with dissolved water* would be more likely to complete the cold, upward journey.

Each channel (or vein) at the Black Canyon has a fairly uniform thickness. This reveals that the liquid's pressure exceeded the rock's pressure by nearly the same amount all along the channel. Again, this would not happen if the flow were slow or had the consistency of cold tar.

This marble-cake appearance is exposed for at least 50 miles along the Gunnison River, so the compressive force must have been about the same over at least those 50 miles. Magma, if it came from one spot below, would tend to escape through the shortest cracks leading to the surface. Instead, magma has filled cracks over a 50-mile range. Consequently, the magma source and any water were probably spread over a large area directly below.

Because similar structures are seen where other deep basement rocks are exposed at the Earth's surface, these gigantic forces either "cropped up" many times at different places or this happened once on a continental or global scale. The parsimony criterion (seeking the simplest explanation) leads us to favor one big event. We will call this **the compression event**.

and Deccan Plateaus. In some regions, high temperatures and extreme pressures from the compression event formed metamorphic rock, such as marble and diamonds. (The next chapter will explain the simultaneous production of deeper and far greater amounts of magma, some of which also escaped to the Earth surface as flood basalts.)

Some high-pressure subterranean water was quickly injected *up* into cracks in the crushed granite. This explains the concentrated saltwater discovered in cracks 7.6 and 5.7 miles under Russia and Germany, respectively. Remember, *surface* water cannot seep deeper than 5 miles,²⁰ implying that *subsurface* water was the source. This explains why the water's salt concentration in these cracks was about twice that of seawater. Because that high concentration of subterranean saltwater mixed during the flood with an approximately equal volume of preflood surface water (which had little dissolved salt), the new oceans gained most of their present salt.



Figure 70: Inner Gorge of the Grand Canyon. The same marble-cake pattern exists in the inner gorge of the Grand Canyon, but with less color contrast than in the Black Canyon of the Gunnison.

We can conclude that ***this crustal rock was rapidly crushed over a wide area. Magma (probably containing dissolved water) was then quickly injected up through the cracks.***

In studying this effect—an immense layer of “marble-cake rock”—we tried to deduce its cause. One can easily err when reasoning from effect back to cause. Another approach, reasoning from cause to effect, requires starting assumptions. We began this cause-to-effect study of the flood on [page 124](#) with only three assumptions and then looked at their logical consequences. When “cause-to-effect reasoning” is consistent with “effect-to-cause reasoning,” as it is here, confidence in our conclusion increases greatly.

As the Mid-Atlantic Ridge and Atlantic floor rose, mass had to shift within the Earth toward the Atlantic. Subsidence occurred on the opposite side of the Earth, especially in the western Pacific, where a granite plate buckled downward, forming trenches. [For details and evidence, see **“The Origin of Ocean Trenches, Earthquakes, and the Ring of Fire”** on pages 153–192.]

Surrounding the Pacific is the “Ring of Fire,” containing the greatest concentration of earthquake and volcanic activity on Earth. On the floor of the Pacific and surrounded by the Ring of Fire, are vast, thick lava flows and 40,000 volcanoes, each taller than 1 kilometer. Frictional heating caused by high-pressure movements under the Pacific floor generated these lava outpourings that covered the Pacific hydroplate.

Therefore, the western Pacific floor is littered with volcanic cones composed of minerals typically found in granite and basalt. Continental crust has been discovered under the Pacific floor. [See Endnote 50 on page 186, and the prediction on [page 170](#).]

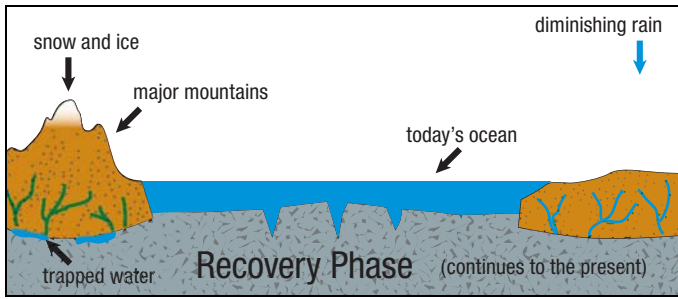

Figure 71: Recovery Phase of the Flood.

Recovery Phase. *Where did the water go?* When the compression event began on a particular hydroplate, the plate crushed, thickened, buckled, and rose out of the water. As it did, the flood waters receded.

Simultaneously, the upward-surging, subterranean water was “choked off” as the plates settled onto the subterranean chamber floor. With the water source largely shut off, the deep, newly-opened basins between continents became reservoirs into which the flood waters returned.

As you will recall, the floor of the subterranean chamber was about 60 miles below the Earth’s surface. Consequently, a few centuries after the flood, sea level was much lower than it is today. This provided land bridges between continents, allowing animal and human migration for perhaps several centuries.

Draining flood waters swept vegetation, its attached bacteria, and sediments onto the new ocean floors. There, the bacteria fed on the vegetation and produced methane. Much of this methane has combined with cold, deep ocean waters to become vast amounts of methane hydrates along coastlines.

Flood waters draining down steep continental slopes eroded deep channels called *submarine canyons*. They are now on the ocean floor, but downstream of today’s major rivers.

After the flood, hydroplates rested on portions of the former chamber floor and oceans covered most other portions. Because the thickened hydroplates applied greater pressure to the floor than did the water, the hydroplates slowly sank into the chamber floor (the mantle) over the centuries, lifting other parts of the deep ocean floor *and raising sea level*. (Imagine covering half of a waterbed with a cloth and the other half with a thick metal plate. The sinking metal plate will lift the cloth.)

As sea level rose in the centuries after the flood, animals were forced to higher ground and were sometimes isolated on islands far from present continental boundaries. Classic examples of this are finches and other animals Charles Darwin found on the Galapagos Islands, 650 miles off the coast of Ecuador. Today, those islands are the only visible remains of a submerged South American peninsula. Darwin believed the finches were blown there during a

giant storm. Even if Darwin’s unlikely storm happened, both a male and female finch, rugged enough to survive the traumatic trip, must have ended up on the same island.

The more sediments continents carried and the thicker continents grew during the compression event, the deeper continents sank. This also depressed the Moho beneath them. Newly formed mountains sank even more, depressing the Moho as deep as 50 miles below the Earth’s surface. [See [Figure 68](#).] As ocean floors rose in compensation, the Moho below them rose as well. This is why continents are so different from ocean bottoms and why the Moho (where it can be detected) is so deep beneath mountains and yet so shallow beneath the ocean floor.

Plateaus. Many other things were far from equilibrium after the continental-drift phase. Over the centuries, the new mountain ranges and thickened continental plates settled slowly toward their equilibrium depth—just as a person’s body sinks into a waterbed. Sinking mountains increased the pressure under the crust on both sides of mountain ranges, so weaker portions of the overlying crust fractured and rose, forming plateaus. In other words, **as continents and mountains sank, plateaus rose**. This explains the otherwise strange aspects of plateaus noted by George Kennedy on page 119 and tells us why plateaus are adjacent to major mountain ranges. For example, the Tibetan Plateau, the world’s largest, is next to the most massive mountain range in the world—the Himalayas. The Tibetan Plateau covers 750,000 square miles and rose to an elevation of about 3 miles. Other dramatic examples are the Colorado Plateau, next to the Rocky Mountains, and the Columbia Plateau, next to the Cascade Mountains. [See **“Plateau Uplift,”** beginning on page 226, for more details.]

Earth Roll. The sudden formation of major mountains altered the spinning Earth’s balance, causing the Earth to slowly roll somewhere between 34°–57°.⁸⁴ The North Pole, then in what is now central Asia, began a slow shift to its present position.⁸⁵ (The shift produced a 6° precession of the Earth’s axis that Dodwell discovered from studying almost 100 astronomical measurements made over the last 4,000 years. (Satellite pictures also support this 6° precession.)⁸⁴ That is why coal,¹³ dinosaur fossils,⁸⁶ and other temperate fossils⁸⁷ are found near today’s South Pole and fossils show that baby hadrosaurs lived year-round in today’s Arctic.⁸⁸ Many researchers have also discovered vast dinosaur and mammoth remains inside the Arctic Circle. All were at temperate latitudes before and during the flood but rolled to their present latitudes after the flood.

The direction and magnitude of the roll are also shown by fossils found inside the Arctic Circle of animals and plants that today live at specific temperate latitudes. Remains of a camel,⁸⁹ horse, bear, beaver, badger, shrew, wolverine, rabbit, and considerable temperate vegetation are found on Canada’s Ellesmere Island, inside the Arctic Circle. Today, these animals and plants require temperatures about 27°F

A Whale of a Tale

For some researchers, the most baffling fossil bed in the world is at Cerro Blanco, Peru, on the western slopes of the Andes Mountains. Found there, 3,800 feet above sea level, are 346 fossilized whales (mostly baleen whales) plus a menagerie of other creatures—sharks, turtles, seals, penguins, ground sloths, and porpoises—all at various depths beneath an elongated strip 370 acres in area.⁹⁰ But in Chile, 870 miles south of Blanco, Peru (and also on the western slopes of the Andes Mountains) are other fossilized desert-whales [See Figure 72.] Both deposits clearly illuminate details of one of the most dramatic events in Earth's history—the *compression event*.

These animals are buried primarily in nonlayered diatomaceous earth (the skeletal remains of diatoms) mixed with clay⁹¹ and volcanic ash. Diatoms are microscopic organisms living near the surface of open water—oceans or lakes. A teaspoon of diatoms contains hundreds of millions of individual skeletons. When diatoms die, their silica skeletons slowly sink. In deep water, the silica often dissolves before reaching the seafloor. Today, in shallow seas, a mushy layer of diatoms can accumulate at rates of up to 0.1 inch per year.

From erosion patterns, researchers at this site could tell that diatomaceous earth was swept in, but how could sea bottom sediments get swept uphill, 3,800 feet above sea level, and why were these sediments so thick—up to 260 feet thick? If the seafloor rose, what forces, energy, and mechanisms were involved? Obviously, the burial of 346 whales and other animals must have been quite rapid to preserve their bodies, not a slow burial at 0.1 inch a year.⁹² And why are land and sea animals buried together? Ground sloths never lived with whales.

The Answer. The continental-drift phase ended with the compression event, the sudden crushing, buckling, and thickening of crashing hydroplates. [Page 486 explains why Earth's mountains, such as the Andes, were pushed up in less than an hour.] Evidence of that compression event can be seen in Figure 50 on page 117, in thousands of similar places on Earth, and in all the “Seashells on Mountaintops” described on page 49. Not only did part of the seafloor rapidly rise to become the Andes Mountains, the overlying water was also lifted. It then drained down the rising slopes and back into the sea, sweeping with it stranded sea creatures and drowned *land* animals. Larger animals (whales, etc.) tended to become lodged in these streams, while smaller animals (fish, etc.) were swept into and out of ponds created by large animals damming up the flow. Sediments (especially diatomaceous earth, easily swept off the rising seafloor) filled these ponds, fossilizing the larger animals. Mystery solved.

More to Come. In the next chapter, you will see that hours before Earth's major mountain ranges suddenly rose, the



Figure 72: Desert Whales. In 2010, more than 80 fossilized whales (adult and juvenile baleen whales and an extinct sperm whale) were discovered in a narrow 65-foot by 800-foot strip near the coastal town of Caldera, Chile—in the Atacama Desert, the driest desert in the world, where rain has never been recorded.⁹³ Other fossils included sharks, a porpoise, a bird with a 17-foot wingspan, an extinct tusked dolphin, and a possible seal.

What concentrated such large and diverse creatures, and how were they fossilized at the western base of the Andes Mountains? A few species (sperm whales, killer whales, and dolphins) sometimes become disoriented and beach themselves, but not baleen whales, or the other powerful swimmers found in this mass graveyard. (SONAR often causes whales to beach themselves, but, of course, SONAR did not exist when these whales died.) Environmental factors might kill some large sea animals, but would not lift them so high,⁹⁴ concentrate them in an area the size of two football fields, and quickly bury them in enough sediments to provide excellent fossilization. Instead, the animals would decompose or be scavenged. If this happened over millions of years, what clustered so many, some overlapping? Even if a whale became trapped in a lagoon, why would a shark—a sleek and powerful swimmer? Besides, what would drive so many different—and large—sea creatures into a lagoon?

Pacific crust was pulled down, steepening the hydroplates' downhill slide. The Ring of Fire, which surrounds the Pacific crust that sank, is the most volcanically-active, earthquake-prone region on Earth. Those initial volcanoes were probably the source of the volcanic ash that was mixed with the diatomaceous earth at the Peruvian site. Both these Chilean and Peruvian fossil sites lie on the thin coastline between the Ring of Fire and the Andes Mountains. [See the inset in Figure 83 on page 152.] As all these animals were fleeing east, away from the deafening sounds and shock waves coming from the west, the compression event began, and the seafloor beneath the animals rose.



PREDICTION 4: The 346 whales fossilized in Peru and the 80 fossilized whales found in Chile are just the tip of the iceberg. Similar fossil graveyards will be found along the western base of the Andes and Rocky Mountains. (In 1976, an 80-foot-long baleen⁹⁵ whale, fossilized in diatomaceous earth, was found in Lompoc, California, “standing” on its tail.⁹⁶)

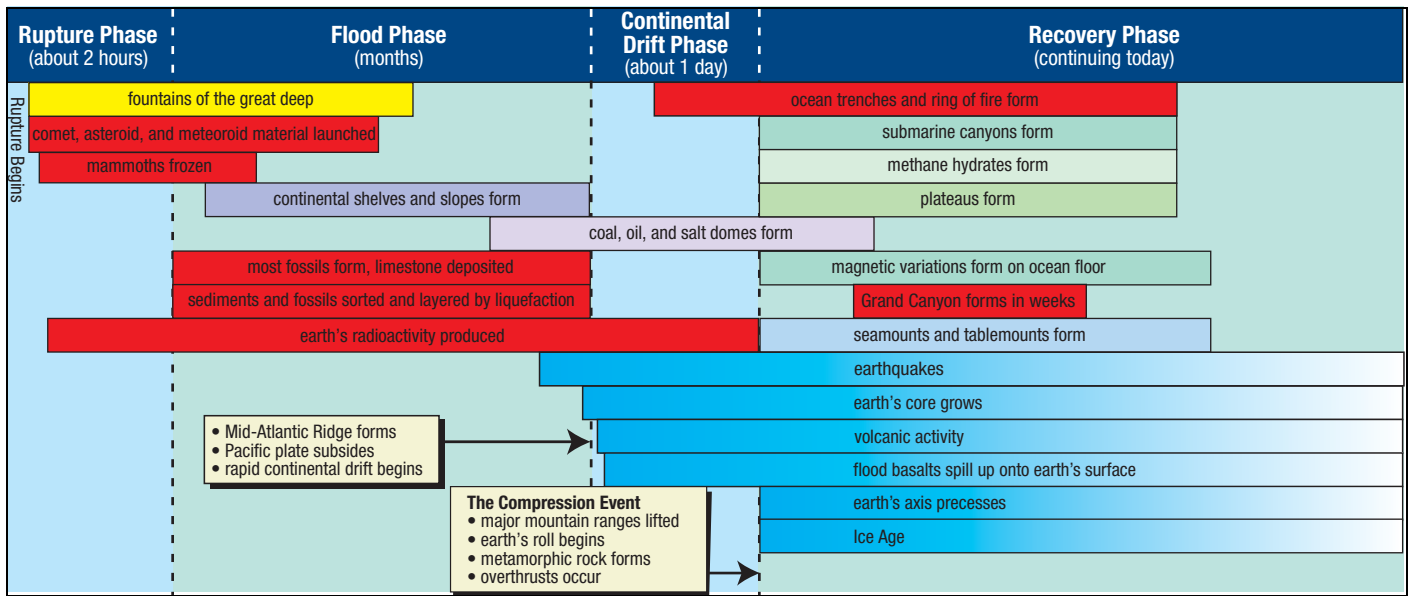

Figure 73: Sequence of Events. Although the flood’s consequences, displayed above, are correctly sequenced, each phase has a different time scale. Each consequence shown in red is the subject of a later chapter. (Notice that the mammoths were frozen during the rupture phase, but the Ice Age began during the recovery phase and is diminishing today. See “[Is Global Warming Occurring? If So, What Causes It?](#)” on pages 495–499.)

warmer in the winter and 18°F warmer in the summer.⁹⁷ Also found are remains of “large lizards, constrictor snakes, tortoises, alligators, tapirs, and flying lemurs—now found only in Southeast Asia.”⁹⁸ Isotopic studies of the cellulose in redwood trees on Axel Heiberg Island, just west of Ellesmere Island, show that they grew in a climate similar to that of today’s coastal forests of Oregon (35° farther south in latitude).⁹⁹

Ellesmere Island and Axel Heiberg Island may have the largest known contrast between current temperatures and inferred ancient temperatures based on fossils. Both islands straddle 85°W longitude. Therefore, regions near this longitude experienced large northward shifts after the flood. On the opposite side of the Earth, the preflood North Pole rolled south near 95°E longitude while, points along 85°W longitude (including today’s North Pole) rolled to the north. Also implied is a roll of at least 34°. Physics,⁸⁴ geology,⁸⁵ and biology^{86–98} give a similar picture.

An ancient historical record tells of a catastrophic flood and an apparent Earth roll. Famous linguist Charles Berlitz reports that early Jesuit missionaries in China located a 4,320-volume work “compiled by Imperial Edict” and containing “all knowledge.” It states,

*The Earth was shaken to its foundations. The sky sank lower toward the north. The sun, moon, and stars changed their motions. The Earth fell to pieces and the waters in its bosom rushed upward with violence and overflowed the Earth. Man had rebelled against the high gods, and the system of the Universe was in disorder.*¹⁰⁰

Endnote 84 explains why the Asian sky began “sinking” toward the north immediately after the flood. Page 586

describes a similar historical account of a “cosmic upheaval” that is preserved in ancient Vedic and classical Sanskrit texts.

David Warner Mathisen, in his book *The Mathisen Corollary*, documents other historical records and monuments showing that cultures worldwide were apparently aware of this temporary “Earth roll.” By precisely tracking what must have been startling changes in star movements in the years after the flood, observers appear to have calculated the rate at which the equinox precesses in Earth’s orbit around the sun: about one degree every 72 years. Today, few could make that measurement, even those who understand the term “the precession of the equinoxes.”¹⁰¹

Canyons. Drainage of the waters that covered the Earth left every continental basin filled to the brim with water. Some of these postflood lakes lost more water by evaporation and seepage than they gained by rainfall and drainage from higher elevations. Consequently, they shrank over the centuries. A well-known example was former Lake Bonneville, part of which is now the Great Salt Lake.

Through rainfall and drainage from higher terrain, other lakes gained more water than they lost. Thus, water overflowed each lake’s rim at the lowest point on the rim. The resulting erosion at that point on the rim allowed more water to flow over it. This eroded the cut in the rim even deeper and caused much more water to cut it faster. Therefore, the downcutting accelerated catastrophically. The entire lake quickly dumped through a deep slit, which we today call a canyon. These waters spilled into the next lower basin, causing it to breach its rim and create another canyon. It was like falling dominoes. The most famous canyon of all, the Grand Canyon, formed

Lake Kashmir



maps: © WorldSat International, 1999, www.worldsat.ca, all rights reserved

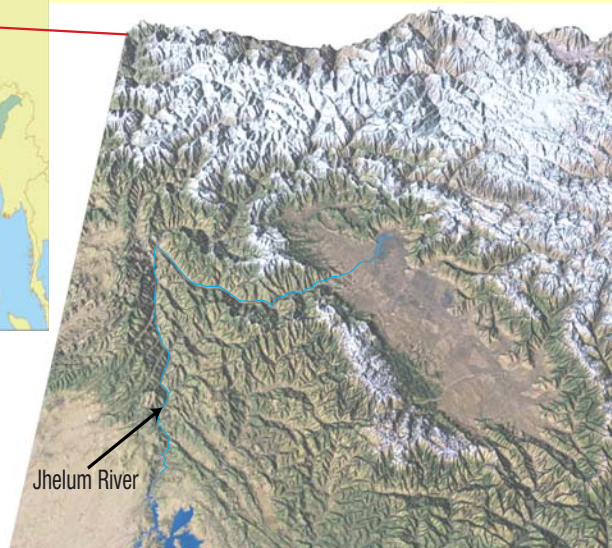

Figure 74: Kashmir Basin Today. Consider whether this region and its bowl-shaped depression quickly rose several miles, carrying in its basin flood waters and fish. If so, the potential existed for “Lake Kashmir” to later overflow its rim and quickly carve a huge canyon, leaving the Jhelum River as a remnant of that event.

While legends and geological facts are consistent with this scenario, two questions remain. What could quickly lift the Himalayas, the most massive mountain range on Earth? Can conventional geology explain these geological facts?

This chapter has answered the first question. Details below address the second question. The Grand Canyon and many other canyons are prime exhibits showing that they too are best explained by a similar catastrophic event. Wouldn't it be nice if eye witnesses could confirm this event? Consider the legend described below.

Kashmir, a disputed territory high on the borders of northern India and Pakistan, has an interesting geological and cultural history. Half of Kashmir's seven million people live in an oval valley the size of Delaware, more than one mile above sea level. That valley is surrounded by high mountains containing fossils of sea life. Rain falling into this bowl-shaped region eventually enters the Jhelum River which flows out between almost vertical canyon walls, 7,000 feet high, in a channel cut through the rim of the bowl.

The Nilamata Purana, written sometime between the sixth and eighth century, contains many Hindu legends. Verses 138–180 tell of a vast, ancient lake that once filled this valley and contained a demonic sea monster who ate people. Hindu gods decided to help the people by cutting an outlet for the lake's waters through the surrounding mountains. Once the lake drained, the hero killed the immobilized monster. Since then, the lake's bottom has been a fertile home for the people of Kashmir, most of whom know this story.

Geologists have confirmed that the valley once held a giant lake! Thinly layered strata (of clay, limestone, and shale containing microscopic seashells) show that the valley was once under water. Was this just a lucky guess by the ancient writers of *The Nilamata Purana* myth? Did they understand geology and create a story to fit the evidence? They would have needed a microscope to see much of the evidence. This myth may be based on human observations of the carving of a huge canyon by the breaching of a natural dam.

Geologists claim that the entire region, including the bordering Himalayan Mountains, rose millions of years ago. If so, the fossils on top should have eroded away, because erosion occurs rapidly in mountainous terrain subject to many freezing-thawing cycles. What lifted this region? How could a lake—and fish—accumulate above a high, remote, draining valley? Even if the valley's outlet had not yet formed, why would a large lake form at that cold, high elevation? Snow or glaciers might accumulate, but rarely a large lake. At high elevations, evaporation rates are generally faster and precipitation rates slower. (Today, the world's largest lake more than a mile above sea level is Lake Titicaca,¹⁰² astride the border of Bolivia and Peru. Kashmir's ancient lake was probably larger.) If such a high lake could not form, or if it breached before it rose millions of years before humans evolved, why does a human account, historical or mythical, speak of the cutting of the canyon as the lake breached?

The hydroplate theory unifies, clarifies, and provides additional details to this cultural and geological picture. As crashing hydroplates crushed, thickened, and buckled, the Himalayan Mountains rose, and the waters drained off the continents. Every basin became a lake, regardless of elevation. Kashmir's lake was immediately full and could have held fish. Later, after people migrated to the region, the lake breached part of its boundary and quickly cut its canyon. Today, the upper Jhelum River is a remnant of that lake. Undoubtedly, other canyons of the world, including the Grand Canyon, formed in a similar way.

primarily by the dam breaching of what we will call **Grand Lake**. It occupied much of southeast Utah, parts of northeastern Arizona, and small areas of Colorado and New Mexico. [See the map on page 214 and pages 215–257.] Grand Lake, standing at an elevation of 5,700 feet above today's sea level, quickly eroded its natural dam 22 miles southwest of what is now Page, Arizona. As a result, the northwestern boundary of former Hopi Lake (elevation 5,950 feet) was eroded, releasing its waters that occupied the present valley of the Little Colorado River.

With thousands of large, high lakes after the flood, many other canyons were carved. “Lake California” filling the Great Central Valley of California carved a canyon (now filled with sediments) under what is now the Golden Gate Bridge in San Francisco. The Strait of Gibraltar was a breach point as the rising Atlantic Ocean eventually spilled eastward into the Mediterranean Basin. The Mediterranean Sea, in turn, spilled eastward over what is now the Bosphorus and Dardanelles, forming the Black Sea.



PREDICTION 5: The crystalline rock under Gibraltar, the Bosphorus and Dardanelles, and the Golden Gate Bridge will be found to be eroded into V-shaped notches. (This prediction, first published in 1995, was confirmed for the Bosphorus and Dardanelles in 1998¹⁰³ and for Gibraltar in 2009¹⁰⁴ and 2018.¹⁰⁵)

Earthquakes. The flood produced great mass imbalances on Earth; today those imbalances cause earthquakes. Continents (crushed, buckled, thickened and loaded with sediments) sank into the mantle and lifted ocean floors. Mountain ranges sank into the mantle and raised plateaus. [See “Plateau Uplift” beginning on page 226.] Shifting material within the Earth is the root cause of earthquakes and the slow shifting of continents. Both phenomena have been misinterpreted as supporting plate tectonics. The next chapter will explain this in greater detail.

Ice Age. As mentioned on page 116, an ice age requires cold continents and warm oceans. Indeed, even the Arctic Ocean was a warm 73°F (23°C) soon after the Mid-Oceanic Ridge formed. While standard climate models, even making use of liberal assumptions, fail to explain this discovery,¹⁰⁶ the flood does.

Sliding hydroplates generated frictional heat, as did movements within the Earth resulting from the rising of the Atlantic floor and subsiding of the Pacific Ocean floor.

Floods of lava spilling out, especially onto the Pacific floor, became vast reservoirs of heat that maintained elevated temperatures in certain ocean regions for centuries—the ultimate and first “El Niño.”¹⁰⁷ Warm oceans produced high evaporation rates and heavy cloud cover.

Temperatures drop about 3.5°F for every 1,000 feet of elevation increase. Therefore, after the flood, the elevated continents and lower sea level produced colder continents. Also, volcanic debris in the air and heavy cloud cover shielded the continents from much of the Sun's rays. Finally, lowered sea levels meant warmer oceans.

At higher latitudes and elevations, such as the newly elevated and extremely high mountains, this combination of high precipitation and low temperatures produced immense snow falls—perhaps 100 times those of today. Large temperature differences between the cold land and warm oceans generated high winds that rapidly transported moist air up onto the elevated, cool continents where heavy snowfall occurred, especially over glaciated areas. As snow depths increased, glaciers flowed downhill in periodic spurts, much like an avalanche. During summer months, rain caused some glaciers to melt partially and retreat, marking the end of that year's “ice age.”

Now that (1) the continents (thickened by the compression event and temporarily elevated) have sunk into the mantle, and (2) the heat produced by the flood has dissipated, the ice ages are ending. Yes, the Earth is slowly warming. [See page 495.]

What's Ahead

Twenty-five major interrelated mysteries have been briefly described and solved. Each of the next eight chapters will examine one of these mysteries in detail: ocean trenches, earthquakes and the Ring of Fire, strata and layered fossils, the Grand Canyon, limestone, frozen mammoths, comets, asteroids and meteoroids, and finally, Earth's radioactivity. Each chapter will contrast the hydroplate theory with all leading explanations and will add a surprising new dimension to the hydroplate theory and to the flood's destructiveness. As you read these chapters, keep in mind that all the theory's details and events were consequences of only three assumptions (explained on page 124) and the laws of physics.

References and Notes

1. See Endnote 89 on page 426 to see how this energy was calculated.
2. The plate tectonic theory, as first proposed, had 6 to 8 plates. This number has grown as followers of the theory have applied it to specific regions of the Earth and found problems with the theory. Although textbooks usually

mention only about a dozen plates, the theory now requires more than 100, most of them small.

This is reminiscent of the use of epicycles, from A.D. 150 to 1543, to explain planetary motion. Ptolemy (A.D. 100–175) proposed that planets revolved about the Earth on *epicycles*—wheels that carried planets and rode on the circumferences

of other wheels. As more was learned about planetary motion, more epicycles were required to protect Ptolemy's geocentric theory. Any theory can appear to explain facts if the theory has enough variables (adjustable parameters).

Both the plate tectonic theory and the hydroplate theory claim that plates have moved over the globe. The plate tectonic theory says that plates move, by an unknown mechanism, slowly for hundreds of millions of years. The hydroplate theory, using an understood mechanism, says that a few hydroplates moved rapidly near the end of a global flood. Upon collision, they fragmented into pieces which today are shifting slowly, but in jerks, toward equilibrium.

As historians of science know, old theories frequently accumulate many anomalies—discoveries that oppose the theory. These problems do not overthrow the theory until a new theory comes along that can explain all that the old theory did *plus* the anomalies. [See Thomas S. Kuhn, *The Structure of Scientific Revolutions* (Chicago: The University of Chicago Press, 1970).] Plate tectonics is becoming more complex as new information is learned, a sign that “epicycles” are with us again. This has caused a growing number of international scientists to announce that *“a lot of phenomena and processes are incompatible with this theory [plate tectonics] ... we must develop competitive hypotheses.”* [A. Barto-Kyriakidis, editor, *Critical Aspects of the Plate Tectonics Theory*, Vol. I (Athens, Greece: Theophrastus Publications, 1990), p. v.]

3. *“Scientists don’t fully understand why Earth has plate tectonics while other planets, such as Venus, don’t.”* Thomas Sumner, “No Plate Tectonics on Super-Earths,” *Science News*, Vol. 188, 25 July 2015, p. 11.
4. Cheinway Hwang and Emmy T. Y. Chang, “Seafloor Secrets Revealed,” *Science*, Vol. 346, 3 October 2014, pp. 32–33.
 - ◆ David T. Sandwell et al., “New Global Marine Gravity Model from CryoSat-2 and Jason-1 Reveals Buried Tectonic Structure,” *Science*, Vol. 346, 3 October 2014, pp. 65–67.
5. Gordon A. Macdonald et al., *Volcanoes in the Sea*, 2nd edition (Honolulu: University of Hawaii Press, 1983), p. 337.
6. W. Jason Morgan, “Rises, Trenches, Great Faults, and Crustal B,” *Journal of Geophysical Research*, Vol. 73, 15 March 1968, p. 1973.
 - ◆ Jürgen Friedrich and Guy G. Leduc, “Curvilinear Patterns of Oceanic Fracture Zones,” *Journal of Geodynamics*, Vol. 37, 2004, pp. 169–179.
7. Ken C. Macdonald and P. J. Fox, “Overlapping Spreading Centers,” *Nature*, Vol. 302, 3 March 1983, pp. 55–58.
8. Vincent E. A. Post et al., “Offshore Fresh Groundwater Reserves as a Global Phenomenon,” *Nature*, Vol. 504, 5 December 2013, pp. 71–78.
9. *“Any successful account of geomagnetism must explain what caused the pole reversals at various times in history. ... No one has developed an explanation of why the sign reversals take place. The apparently random reversals of the Earth’s dipolar field have remained inscrutable.”* Charles R. Carrigan and David Gubbins, “The Source of the Earth’s Magnetic Field,” *Scientific American*, Vol. 240, February 1979, p. 125.
10. Arthur D. Raff, “The Magnetism of the Ocean Floor,” *Scientific American*, October 1961, pp. 146–156.

This paper is enlightening, because it shows some understanding of these magnetic anomalies (and even localized reversals) before the plate-tectonic interpretation was given to the anomalies. Once the plate-tectonic interpretation was given, few considered these more likely mechanisms.
11. R. S. Coe and M. Prevot, “Evidence Suggesting Extremely Rapid Field Variations during a Geomagnetic Reversal,” *Earth and Planetary Science Letters*, Vol. 92, 1989, pp. 292–298.
 - ◆ R. S. Coe, M. Prevot, and P. Camps, “New Evidence for Extraordinarily Rapid Change of the Geomagnetic Field during a Reversal,” *Nature*, Vol. 374, 20 April 1995, pp. 687–692.
 - ◆ Roger Lewin, “Earth’s Field Flipping Fast,” *New Scientist*, Vol. 133, 25 January 1992, p. 26.
12. The Mid-Ocean Canyon begins between Canada and Greenland and extends south 2,300 miles.
13. Quinn A. Blackburn, “The Thorne Glacier Section of the Queen Maud Mountains,” *The Geographical Review*, Vol. 27, 1937, p. 610.
 - ◆ Ernest Henry Shackleton, *The Heart of the Antarctic*, Vol. 2 (New York: Greenwood Press, 1909), p. 314.
 - ◆ Stefi Weisburd, “A Forest Grows in Antarctica,” *Science News*, Vol. 129, 8 March 1986, p. 148.
 - ◆ Richard S. Lewis, *A Continent for Science: The Antarctic Adventure* (New York: Viking Press, 1965), p. 134.
14. Lewis, p. 130.
15. “[Canada’s Ellesmere Island, well inside the Arctic Circle, was] *warm enough throughout the year to sustain palm trees and other tropical flora and fauna.*” Daniel B. Kirk-Davidoff et al., “On the Feedback of Stratospheric Clouds on Polar Climate,” *Geophysical Research Letters*, Vol. 29, 15 June 2002, p. 51–1.
 - ◆ *“On eastern Axel Heiberg Island [in northern Canada], ... fossil forests are found. ... just 680 miles from the North Pole. The stumps of ancient trees are still rooted in the soil and leaf litter where they once grew. ... many trees reaching more than a hundred feet in height.”* Jane E. Francis, “Arctic Eden,” *Natural History*, Vol. 100, January 1991, pp. 57–58.
16. Carl K. Seyfert and Leslie A. Sirkin, *Earth History and Plate Tectonics*, 2nd edition (New York: Harper & Row, 1979), p. 312.
17. *“... at almost 2.5 km beneath the sea floor, microbial life is not only present and compositionally distinct from that in shallower sediments, but also producing methane.”* Huber, Julie A., “Making Methane Down Deep,” *Science*, Vol. 349, 24 July 2015, p. 376.
18. *“Estimates vary widely, but most experts agree that marine gas hydrates collectively harbor twice as much carbon as do all known natural gas, crude oil and coal deposits on Earth.”*

- Erwin Suess et al., “Flammable Ice,” *Scientific American*, Vol. 281, November 1999, p. 78.
- ◆ “... even by the most conservative estimates, the energy dormant in natural gas hydrates worldwide is double that of all conventional fossil fuel deposits combined.” Matthew R. Walsh et al., “Microsecond Simulations of Spontaneous Methane Hydrate Nucleation and Growth,” *Science*, Vol. 326, 20 November 2009, p. 1095.
19. “Dating of an ice core is prerequisite for proper interpretation of a data series. A number of dating methods have been developed on the basis of ice flow models, and analyses of isotopes, volcanic debris and continental dust in ice cores. Most accurate are the stratigraphical methods, that is, detection and counting of the individual annual layers downwards from the surface. In areas with high accumulation (>25 cm ice year⁻¹) and no melting, these methods allow absolute dating to within a few years per thousand if the ice core is in perfect physical condition. This accuracy is required when high-frequency components of the time series are to be compared with similar features in other time series. For example, the acidity of annual layers could be reconciled with historical records of volcanic eruptions within the past millenium only because each layer was dated back to near the correct year of deposition. **So far, no ice core has been absolute-dated beyond AD 553.** [emphasis added] W. Dansgaard, “Ice Core Studies: Dating the Past to Find the Future,” *Nature*, Vol. 290, 2 April 1981, p. 360.
 20. See “**Highly Compressed Solids**” on page 608.
 21. John Woodmorappe and Michael J. Oard, “Field Studies in the Columbia River Basalt, North-West USA,” *Technical Journal*, Vol. 16, No. 1, 2002, pp. 103–110.
 22. Richard A. Kerr, “Looking—Deeply—into the Earth’s Crust in Europe,” *Science*, Vol. 261, 16 July 1993, pp. 295–297.
 - ◆ Richard A. Kerr, “German Super-Deep Hole Hits Bottom,” *Science*, Vol. 266, 28 October 1994, p. 545.
 - ◆ Richard Monastersky, “Inner Space,” *Science News*, Vol. 136, 21 October 1989, pp. 266–268.
 - ◆ Richard A. Kerr, “Continental Drilling Heading Deeper,” *Science*, Vol. 224, 29 June 1984, p. 1418.
 23. Yevgeny A. Kozlovsky, “Kola Super-Deep: Interim Results and Prospects,” *Episodes*, Vol. 5, No. 4, 1982, pp. 9–11.
 24. The geothermal gradient in a few continental regions far from volcanoes varies from 10° to 60°C per kilometer.
 25. Harvey Blatt, *Sedimentary Petrology* (New York: W. H. Freeman and Co., 1982), pp. 3, 6, 241.
 26. In Norway, China, and Kazakhstan, tiny diamond grains have been found in nonvolcanic, metamorphosed, crustal rocks that were once sediments. [See Larissa F. Dobrzhinetskaya et al., “Microdiamond in High-Grade Metamorphic Rocks of the Western Gneiss Region, Norway,” *Geology*, Vol. 23, July 1995, pp. 597–600 and Richard Monastersky, “Microscopic Diamonds Crack Geologic Mold,” *Science News*, Vol. 148, 8 July 1995, p. 22.]
 27. John V. Walther and Philip M. Orville, “Volatile Production and Transport in Regional Metamorphism,” *Contributions to Mineralogy and Petrology*, Vol. 79, 1982, pp. 252–257.
 28. George C. Kennedy, “The Origin of Continents, Mountain Ranges, and Ocean Basins,” *American Scientist*, Vol. 47, December 1959, pp. 493–495.
 29. Larry Gedney, “The World’s Deepest Hole,” *Alaska Science Forum*, Article 725, 15 July 1985, p. 2.
 30. “... we estimate the depth of the mother salt layer as about 20,000 feet in the Texas Gulf Coast. This is in general agreement with estimates on the same basis made by Barton.” L. L. Nettleton, “Fluid Mechanics of Salt Domes,” *Bulletin of the American Association of Petroleum Geologists*, Vol. 18, September 1934, p. 1177.
 31. “As the name suggests, it was once thought that evaporites formed exclusively from the drying out of enclosed marine basins. This required improbably large volumes of seawater to provide the resultant evaporites.” R. C. Selley, “Mineralogy and Classification,” *Encyclopedia of Geology* (Amsterdam: Elsevier, 2005), p. 31.
 - ◆ Robert S. Dietz and Mitchell Woodhouse, “Mediterranean Theory May Be All Wet,” *Geotimes*, May 1988, p. 4.
 32. Kenneth J. Hsu, *The Mediterranean Was a Desert* (Princeton, New Jersey: Princeton University Press, 1983).
 33. The United States National Research Council, in 2000, compiled a list of the eleven “Greatest Unanswered Questions of Physics.” This listing included such questions as “What Is Dark Matter?” “What Is Dark Energy?” and “How Did the Universe Begin?” This book points out the faulty science that led to these unanswerable questions.

Another of those eleven unanswered questions is relevant to the flood: “How Were the Heavy Elements from Iron to Uranium Made?”

But when fusion creates elements that are heavier than iron, it requires an excess of neutrons. Therefore, astronomers assume that heavier atoms are minted in supernova explosions, where there is a ready supply of neutrons, although the specifics of how this happens are unknown. [See Eric Haseltine, “The Greatest Unanswered Questions of Physics,” *Discover*, February 2002, p. 40.]

Where the heaviest elements, such as uranium and lead, came from still remains something of a mystery. Ibid., p. 41.
 34. James Lattimer, as quoted by Andrew Grant, “Atom Sheds Light on Neutron Stars,” *Science News*, Vol. 183, 9 March 2013, p. 16.
 35. “*But simulations* [of supernovas] *show that these explosions have an insufficient quantity of neutrons.*” Grant, p. 17.
 36. Barry Setterfield, “An Investigation That Led to Unexpected Results by the Late Mr. G. F. Dodwell, B.A., F.R.A.S., South Australian Government Astronomer, 1909–1952,” *Bulletin of the Astronomical Society of South Australia*, September 1967.

- ◆ Another data point that could be added to Dodwell's long list is the Great Pyramid of Egypt. For it to line up with today's cardinal directions, it would need to be rotated about 3 degrees counterclockwise. The pyramid's builders were much too skilled to have made such a large error.
- 37. See Endnote 5 on page 326.
- 38. See "[Meteorites Return Home](#)" on page 351.
- 39. "[Strikingly large concentrations of iridium were also observed \[in the eruption debris of Hawaii's Kilauea volcano\], the ratio of iridium to aluminum being 17,000 times its value in Hawaiian basalt.](#)" William H. Zoller et al., "Iridium Enrichment in Airborne Particles from Kilauea Volcano: January 1983," *Science*, Vol. 222, 9 December 1983, p. 1118.
 - ◆ Charles Officer and Jake Page, *The Great Dinosaur Extinction Controversy* (Reading, Massachusetts: Addison-Wesley Publishing Co., Inc., 1996), pp. 110–124.
- 40. *Ibid.*, pp. 98, 114–115, 117–121.
- 41. "[Taken together, our analyses indicate that the end-Cretaceous mass extinction was a globally uniform event.](#)" David M. Raup and David Jablonski, "Geography of End-Cretaceous Marine Bivalve Extinctions," *Science*, Vol. 260, 14 May 1993, p. 973.
- 42. Sometimes, the popular press has announced the discovery of craters that might explain the extinction of dinosaurs. Usually, after the initial fanfare, other discoveries falsified the explanation.
- 43. Officer and Page, pp. 151–156.
 - ◆ Rex Dalton, "Hot Tempers, Hard Core," *Nature*, Vol. 425, 4 September 2003, pp. 13–14.
 - ◆ "[To date, no one has found iridium associated with Chicxulub.](#)" Gerta Keller, as quoted by Barry DiGregorio, "Doubts on Dinosaurs," *Scientific American*, Vol. 292, May 2005, p. 28.
- 44. "[The stability of the high-heat flow vapor-emanation phase for at least 4 years calls for an unusually large and constant heat source beneath this area.](#)" Andrea Koschinsky et al., "Hydrothermal Venting at Pressure-Temperature Conditions above the Critical Point of Seawater, 5°S on the Mid-Atlantic Ridge," *Geology*, Vol. 36, August 2008, p. 617.
 - ◆ "[Even Jules Verne didn't foresee this. Down at the bottom of the Atlantic Ocean is the hottest water on Earth, in a 'supercritical' state never seen before in nature ... and could offer a glimpse of how minerals such as gold, copper and iron are leached out of the entrails of the Earth and released into the oceans. Its water, but not as we know it ...](#)" Catherine Brahic, "Superheated Water Spews from the Seabed," *New Scientist*, Vol. 198, 9 August 2009, p. 14.
- 45. "[Helium has two stable isotopes, ³He and ⁴He, and hydrothermal water is enriched in ³He relative to the proportion found in atmospheric helium—there is said to be excess ³He. The presence of excess ³He therefore indicates water of hydrothermal origin.](#)" Kazuhiro Misumi, "Iron's Voyage from the Abyss," *Nature*, Vol. 523, 9 July 2015, p. 160.
- 46. "[Some tubeworm aggregations were completely embedded in solidified tar, indicating that they were later overcome by flows.](#)" I. R. MacDonald et al., "Asphalt Volcanism and Chemosynthetic Life in the Campeche Knolls, Gulf of Mexico," *Science*, Vol. 304, 14 May 2004, p. 1000.
 - ◆ Martin Hovland et al., "Chapopote Asphalt Volcano May Have Been Generated by Supercritical Water," *Eos*, Vol. 86, 18 October 2005, pp. 397–398.
- 47. Cracks propagate rapidly through solids under tension, because much of the tensile stress is concentrated at the tips of the cracks. Also, pressure waves travel about twice as fast through solids as they do through liquids, so the crack will race ahead of the pressure drop in the water below. If the crust were not in tension, the crack would not grow.
- 48. Large earthquakes rupture (in both directions) at speeds approaching 3 mi/sec—nearly the speed of sound in rock. [See Michel Bouchon and Martin Vallée, "Observation of Long Supershear Rupture during the Magnitude 8.1 Kunlunshan Earthquake," *Science*, Vol. 301, 8 August 2003, pp. 824–826.]

As the flood began, the crack's two ends circumscribed the globe and produced the 46,000-mile rupture in about 2 hours.

$$\frac{46,000 \text{ mi}}{2 \times 3.0 \frac{\text{mi}}{\text{sec}} \times 3600 \frac{\text{sec}}{\text{hr}}} = 2.1 \text{ hours}$$

The pressure drop in the subterranean chamber began immediately below the rupture and then propagated horizontally through the liquid shell at the speed of sound in water, which is only about a third of the speed of sound in rock.

The *rupture* did not begin in what is now the Atlantic as some people have thought. (The later upbuckling of the *Mid-Oceanic Ridge* began in the Atlantic.) Notice on the map on [page 112](#) that the *Mid-Oceanic Ridge* intersects itself only once (in the Indian Ocean). The end of the crack that passed south of what is now Africa must have reached that intersection *after* the other end of the crack had passed by that point as it traveled to the northwest. Therefore, if the rupture began anywhere between what is now the North Pole and Alaska, the two ends of the crack (traveling at the same speed) would have formed that intersection in the Indian Ocean.

Also, by starting anywhere in that 2,500-mile region, *the crack always propagated through crust that was still in tension from the pressure below. (Tension cracks grow only through solids that are in tension.)* Therefore, the crack *raced ahead of the dropping pressure in the subterranean water.*
- 49. Yes, the *Mid-Oceanic Ridge* encircles the Earth, generally along a *great-circle path*. On maps showing the *Mid-Oceanic Ridge*, it may seem to disappear along the northwest coast of North America. However, if you place red dots everywhere an earthquake occurs, most of those dots will form a continuous red line along the *Mid-Oceanic Ridge*. That line goes under the northwest coast of North America. So, the ridge lies under California, western Canada, and Alaska. The North American plate overrode that segment of the ridge at the end of the continental-drift phase.

50. Robert Vickers Dixon, *Treatise on Heat* (Dublin: Hodges and Smith, 1849), pp. 143–144.
51. For more on tidal pumping, see pages 595–596.
52. In water at room temperature and atmospheric pressure, about one in a billion water molecules is *ionized*. That is, the random vibrations of water molecules sometimes break a molecule (H₂O), which has no net electrical charge, into H⁺ and OH⁻ (a positive and negative charge). Because they are electrically charged, the particles are said to be *ionized*. The more ionized the water, the easier it is for water to conduct an electrical current.

Energy is required to pull positive and negative charged particles apart, but that energy is recovered if those charges recombine, as positive and negative charges always try to do. If you expend energy by rubbing your shoes on a carpet, some electrons from the carpet stick to your shoes. Your body becomes negatively charged, and your hair will tend to stick out. Then, if you touch the nose of your unsuspecting sister, a spark will jump between your finger and her nose; energy is released instantly, much to your sister's surprise.

As the temperature of the subterranean water increased, its ionization increased. At the temperatures and pressures in the subterranean water, each gram of water was ionized hundreds of millions of times more than the water you drink. When the flood began, the temperature and pressure of the water jetting up through the rupture suddenly dropped, so oppositely charged electrical particles slammed together, thereby converting the electrical (ionization) energy into heat that then accelerated the water to even greater speeds.

- ◆ For a good discussion of the ionization of water at high temperatures and pressures, see E. U. Franck, "Fluids at High Pressures and Temperatures," *Pure and Applied Chemistry*, Vol. 59, No. 1, 1987, pp. 25–34.
53. "Both numerical simulations and laboratory experiments confirm that supercritical out-salting is a viable process of geological significance for the formation and accumulation of evaporites." Martin Hovland et al., "Sub-Surface Precipitation of Salts in Supercritical Seawater," *Basin Research*, Vol. 18, 2006, p. 221. (Figure 2 on page 223 of that paper shows the pressure-temperature curve at which "out-salting" occurs.)
54. Conduction and convection (including boiling) within the liquid remove relatively little heat *from the liquid*; radiation at these temperatures is small.
55. Conversely, if the pressure increases, a small amount of vapor quickly condenses, on each liquid droplet, releases its heat of condensation, which then keeps the remaining vapor from condensing. This explains why no amount of pressure can liquefy all the water vapor.
56. Philippe Wernet et al., "Spectroscopic Characterization of Microscopic Hydrogen-Bonding Disparities in Supercritical Water," *The Journal of Chemical Physics*, Vol. 123, 12 October 2005, pp. 154503-1–154503-7.

What this paper calls "small patches of hydrogen bonded water molecules," I am calling shimmering, microscopic droplets.

- ◆ M. C. Bellissent-Funel, "Structure of Supercritical Water," *Journal of Molecular Liquids*, Vol. 90, February 2001, pp. 313–322.
57. In addition to the physical processes described on pages 126 and 477, this is also seen by studying the Clausius-Clapeyron equations found in any good advanced thermodynamics textbook.
58. [See "The Origin of Earth's Radioactivity" on pages 379–433.] Because the expanding vapor had such high kinetic energy, the mass of rocks that escaped Earth's gravity was comparable to the mass of jetting water.
59. The energy in the subterranean chamber was vastly greater than one would suspect by simply examining a steam table. Steam tables do not include the dominant forms of energy that were in the subterranean water, namely (1) ionization energy (explained in Endnote 52 and sometimes called energy of dissociation), (2) surface energy, (3) chemical energy from burning within SCW, and (4) nuclear energy. [See "Energy in the Subterranean Water" on pages 597–602 and "The Origin of Earth's Radioactivity" on pages 379–433.]
- What is surface energy? Energy is required to create a surface, because chemical bonds must be broken. Immediately before the rupture, the total surface area of all *microscopic* liquid bundles in the SCW was about a trillion times greater than before tidal heating began. (Furthermore, the polar nature of water molecules gives liquid water unusually high surface energy.) Therefore, as tidal pumping added energy to the SCW, most of that energy (1) ionized both the liquid and vapor, and (2) increased the total surface area of the liquid bundles by further fragmenting the microscopic liquid particles. Consequently, temperatures did not rise as much as one might expect. Based on the Widmanstätten patterns found in iron meteorites (which came from crushed subterranean pillars), temperatures exceeded 1,300°F. [See Figure 185 on page 341.]
60. Baron Cagniard de la Tour and most researchers before 2005 thought supercritical fluids (SCFs) were gases. They were wrong, although at the macroscopic level, SCFs behave in many ways as gases. Unseen were microscopic droplets of liquid floating throughout the dense vapor. These shimmering droplets account for many amazing properties of SCFs.
- De la Tour's fluids included ether and alcohol. With water, he could not reach the critical point, because of its high temperature and pressure—705°F (374°C) and 3,200 psi (220.6 bars). Also, his glass tubes were attacked by the high solubility of water as it approached the critical point.
61. A well-known novelty item, the lava lamp, demonstrates some aspects of this. A lava lamp is a vertical, transparent tube containing two brightly colored liquids with slightly different densities. A light bulb at the bottom heats the denser liquid, causing it to expand (become less dense) and float up into the liquid above. Because the densities are almost equal, a slight undulation in the lower liquid will rise far into the liquid above and then pinch off to become a droplet. Sometimes droplets collide and merge.
62. Each liquid droplet is compressed by the surface tension of its "skin," similar to the stretched rubber of a balloon compressing the air inside the balloon. The pressure increase

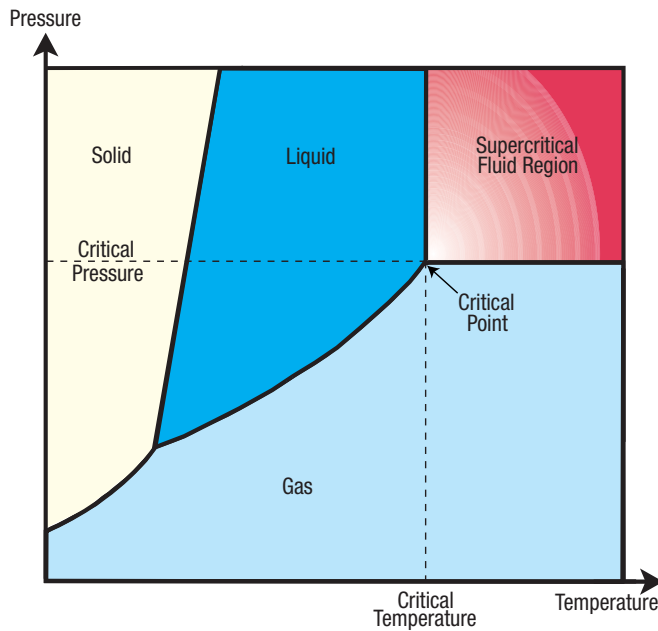

Figure 75: Supercritical Fluid Region. Most of us were taught as children that pure substances can be one of three forms: a solid, liquid, or gas. Usually omitted was a fourth form: supercritical fluids. Although supercritical fluids were discovered in 1822, even teachers are usually unaware of their existence. Any pure substance (such as water, carbon dioxide, or lead) is supercritical when its pressure and temperature exceed those of its critical point—the pressure-temperature combination at which the density of the liquid and vapor are equal. The critical point for water is 705°F (374°C) and 3,200 psi (220.6 bars). For carbon dioxide, the critical point is 88°F (31°C) and 1,072 psi (74 bars).

is inversely proportional to the droplet's radius. Because the liquid droplets in supercritical fluids are so small, these intermolecular forces are huge. Therefore, the liquid's pressure and "boiling point" are much greater than one might expect, so even at very high temperatures, the droplets can remain in the liquid state. Therefore, SCW cannot boil.

63. "When the solid is precipitated by suddenly reducing the pressure, it is crystalline, and may be brought down as a 'snow' in the gas, or on the glass as a 'frost,' but it is always easily redissolved by the gas on increasing the pressure." J. B. Hannay and James Hogarth, "On the Solubility of Solids in Gases," *Proceedings of the Royal Society*, Vol. 29, 1879, p. 326.
64. Extremely high-velocity water droplets can cut steel and other hard solids, much as a knife cuts butter.
65. In 1964, one of the first solids dissolved in a SCF for economic purposes was caffeine from coffee beans. This produced decaffeinated coffee. Organic wastes and toxic substances (such as the agents in chemical weapons) can be dissolved in SCFs and rendered harmless. The SCF is usually carbon dioxide (CO₂), because it is cheap, nontoxic, nonflammable, and its critical point, 88°F (31°C) and 1,072 psi (74 bars), is so low.
66. Sanjay Limaye, as quoted by Dennis Normile in "Japanese Probe Primed for a Second Run at Venus," *Science*, Vol. 350, 4 December 2015, p. 1142.
 - ◆ "... the drivers [of this super-rotation] remain mysterious." Paul Voosen, "Jilted Again, Venus scientists Pine for their

Neglected Planet," *Science*, Vol. 355, 13 January 2017, p. 116.

67. Vibrating hydroplates are explained in "Water Hammers and Flutter Produced Gigantic Waves" on page 197.
68. Elizabeth Gibney, "Rescued Akatsuki Spacecraft Delivers First Results from Venus," *Nature*, Vol. 532, 14 April 2016, p. 157–158.
69. "Heat transfer from a magmatic intrusion to groundwater occurs at depths below drilled geothermal reservoirs and, due to a lack of direct observations, the deep, very high-temperature parts of geothermal systems are not well understood." Samuel Scott et al., "Geologic Controls on Supercritical Geothermal Resources above Magmatic Intrusions," *Nature Communications*, Vol. 6, 27 July 2015, p. 2.

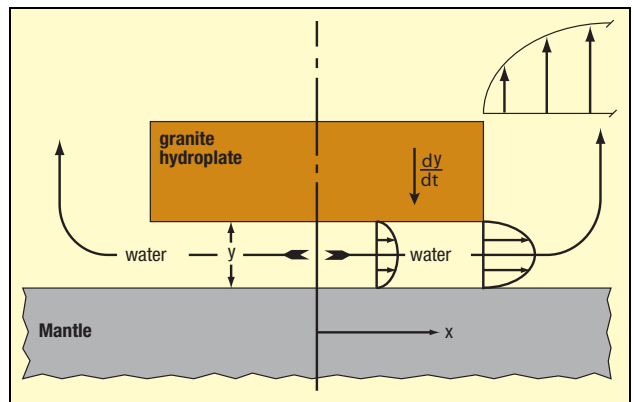

Figure 76: Water Flowing from under a Hydroplate.

70. Even if the water trapped in the spongelike pockets was not forced back into the subterranean chambers, the plate would settle very slowly, for other reasons. Consider a semi-infinite hydroplate, settling at a rate $\frac{dy}{dt}$ and overlying a water layer of thickness y . A water particle exactly below the center of the plate will not move, because it is "undecided" whether to flow to the right or left, but the farther a particle is from the center, the faster it will flow. A simple conservation-of-mass calculation shows that a typical water particle at a distance x from the plate's center will move with a velocity of $\frac{x}{y} \frac{dy}{dt}$.

The water's steadily increasing speed and decreasing pressure in the downstream direction expanded the water and produced increasing viscous flow resistance and back pressure from that expansion. Also, the increasing load of sediments, especially from crushed pillars, slowed the flow.

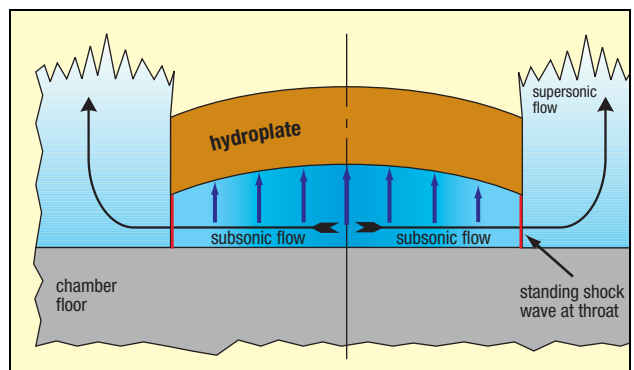

Figure 77: Subsonic-Supersonic Transition at Edge of Hydroplate.

Because the water's pressure decreases in the direction of flow, edges of the hydroplate have less pressure support from below (blue vertical arrows in Figure 77). The plate became concave downward. Flow below the plate is in converging channels, and therefore, subsonic, until the edge of the plate is reached. This edge becomes the *throat* (shown in red) of a converging-diverging "nozzle." There the flow is *choked*; that is, it cannot exceed the relatively slow velocity of sound in water. However, as water passes that constriction, it accelerates supersonically. (For details, consult any textbook on compressible flow.) The volume of water accelerates upward and expands powerfully, because so much nuclear energy (in the form of heat and pressure) was added to that water as it escaped from under the crust. [See "[The Origin of Earth's Radioactivity](#)" on pages 379–433.] As the plate settles toward the chamber floor, the throat's area narrows, so the volume flow rate out from under the plate decreases, causing the plate to settle even more slowly.

Velocity and erosion from the upward expanding flow will increase as the top of the plate is approached. When the plate finally settles onto the chamber floor, it will have a continental shelf and a continental slope. [See Figures 44, 47, and 61.]

71. T. McKenny Hughes, "Bursting Rock Surfaces," *Geological Magazine*, Vol. 3, 1887, pp. 511–512.
72. J. P. Den Hartog, *Advanced Strength of Materials* (New York: McGraw-Hill, 1952), pp. 141–171.
73. John Larsen, "From Lignin to Coal in a Year," *Nature*, Vol. 314, 28 March 1985, p. 316.

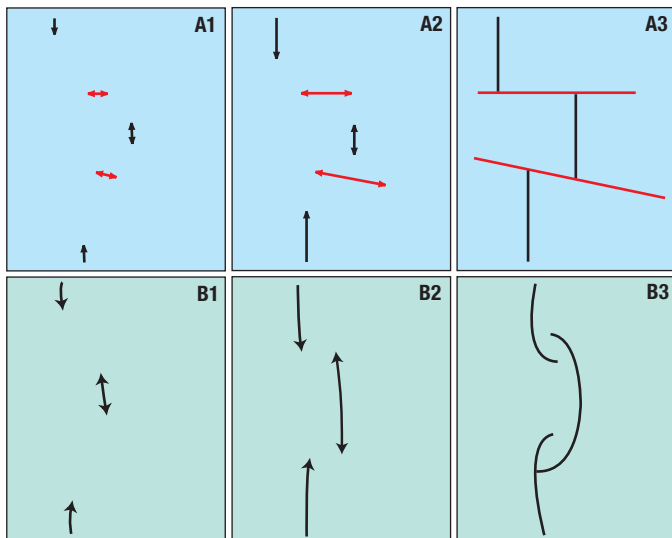

Figure 78: Growth of Two Types of Cracks along Mid-Oceanic Ridge. Figures A1–A3 illustrate the growth of fracture zones (shown in red) and the formation of the offset pattern all along the Mid-Oceanic Ridge. [Compare A3 with Figure 44 on page 112.] If no cracks form perpendicular to the rising ridge, as shown in B1–B3, the axial rifts will often grow past each other, forming overlapping spreading centers as shown in B3 and in Figure 46 on page 114.

74. Compressed solids, liquids, and gases store energy. Springs are common examples. If a force, F , compresses some material by a small amount, D , the additional energy stored in the material is $F \times D$. If the compressed material is rock, D will be small, but F will be huge. The product of the two

could be very large. The compressive energy stored in the Earth's mantle and core is immense.

Just before the rupture, the strain energy in the crust would have been about 1.2×10^{30} ergs. The released energy, as the Mid-Oceanic Ridge sprung upward, was about 10^{33} ergs. (This is explained beginning on page 132.) Only a small fraction of this energy was needed to form mountains. (In International Standard Units, a 1-megaton hydrogen bomb releases 4.184×10^{22} ergs of energy.) Two of the most violent volcanic eruptions in modern times, Tambora in 1815 and Krakatau in 1883, released about 8.4×10^{26} ergs and 10^{25} ergs, respectively. [Gordon A. Macdonald, *Volcanoes* (Englewood Cliffs, New Jersey: Prentice-Hall, 1972), p. 60.]

75. Pillars (places where the crust sagged slightly and touched the chamber floor) did provide resistance, but only initially. Sliding pillar bases would have instantly become hot liquid magma, which is itself slick.
76. As the Mid-Oceanic Ridge rose, its surface stretched in two perpendicular directions. Because rock is weak in tension, two types of cracks grew, each perpendicular to a direction of stretching. Both types of cracks are shown in Figures 44, 65, 66f, and 78.

Just as the tops of the spring's coils are farther apart on page 132 in (c) than (a) or (b), so the surface of the ridge was stretched perpendicular to its axis. One can also feel this type of stretching by grabbing a phone book firmly in both hands and arching it. The outer cover is placed in tension.

The other type of stretching was along the ridge axis. A circle's circumference increases as its radius grows. Likewise, the entire length of the ridge's crest was stretched as the ridge moved farther from the center of the Earth.

Each type of crack began as a microscopic opening with stress concentrations at both ends. As the ridge rose, both types of cracks grew perpendicular to each other. Cracks along the ridge axis, called *axial rifts*, began at different locations along the ridge crest. Later, flank rifts, also parallel to the ridge axis, formed farther down the flanks of the ridge. Axial rifts formed before flank rifts because the greatest curvature, and therefore, greatest tension, occurs at the ridge crest. Rifts stopped growing when they ran into the perpendicular cracks called *fracture zones*. However, fracture zones never ran into axial rifts, because fracture zones always began at the crest, where the ridge was farthest from the center of the Earth. [See A1–A3 in Figure 78.] Both types of cracks are still growing, although sporadically and at a much slower rate. This is due to cooling and thermal contraction, and it accounts for much earthquake activity along the ridge.

As the ridge rose, hundreds of short axial rifts began growing at different places along the rupture path. The more the ridge rose, the longer and wider these cracks became. This created a line of bending weakness, which caused the ridge to rise symmetrically with the axial rift. In general, each axial rift did not align with the next axial rift, so segments of the Mid-Oceanic Ridge are offset from each other at fracture zones.

Lengthening axial rifts also explain overlapping spreading

centers (OSCs), where two portions of the ridge axis overlap. Macdonald and Fox, who first reported on OSCs, demonstrated how the overlaps occur. [See Endnote 7 on page 141.] They took a knife and made two parallel cuts in the top of a block of frozen wax—one cut ahead of the other. The block was then pulled perpendicular to both cuts, causing adjacent cuts to grow slightly past each other. Overlapping ends then turned toward each other. Sometimes they intersected. [See Figure 46 on page 114 and B1–B3 in Figure 78.] This suggests that OSCs were formed by lengthening axial rifts as the ridge rose. OSCs contradict the plate tectonic theory.

Another test of the hydroplate theory vs. the plate tectonic theory concerns the cross-sectional profile of fracture zones. According to the hydroplate theory, fracture zones are tension cracks formed when the ridge suddenly rose and was stretched parallel to the ridge axis. The cracks grew from the surface downward, so their profiles should be V-shaped or trough-shaped. [See Figure 79 (a).] Relatively shallow cracks will be V-shaped; deep cracks will be trough-shaped, because the pressure is so great at the base of the crack that the rock would flow as the sides of the crack are pulled apart. The plate tectonic theory says that a fracture zone formed by horizontal shearing. If so, the profile should look as shown in Figure 79 (b). These two predictions were jointly made on April 30, 1986 with the late Robert S. Dietz, one of the developers of the plate tectonic theory. Bob Dietz and I then set out to learn the actual shape of fracture zones.

The true profiles confirm the hydroplate prediction. [See Tjeerd H. van Andel et al., “The Intersection between the Mid-Atlantic Ridge and the Vema Fracture Zone in the North Atlantic,” *Journal of Marine Research*, Vol. 25, 15 September 1967, pp. 343–351. See also A. A. Meyerhoff and Howard A. Meyerhoff, “Tests of Plate Tectonics,” *Plate Tectonics: Assessments and Reassessments*, editor Charles F. Kahle (Tulsa: American Association of Petroleum Geologists, 1974), p. 108.]

This exercise produced two other surprising confirmations of the hydroplate theory. First, the actual fracture zones were trough-shaped near the ridge axis where the fractures should be deepest. At the ends of fracture zones, the profiles were V-shaped. The second surprise was the presence of undeformed, layered sediments inside fracture zones. If opposite sides of a fracture zone are sliding past each other, as plate tectonics claims, sediments caught between the sliding plates would be highly deformed.

Plate tectonic theory predicts and, some textbooks erroneously claim, that earthquakes in fracture zones occur only between the two offset ridge axes, where the plates, according to plate tectonics, are moving in opposite directions. To the contrary, earthquakes occur all along fracture zones, as the hydroplate theory predicts.

77. Basalt is highly magnetic because it contains magnetite and hematite. Magnetic material will lose its magnetism if its temperature exceeds a certain value called the *Curie Point*. Increasing the pressure on these minerals raises the Curie Point. At the Earth’s surface, the Curie point for basalt is near 578 °C.

A typical cross section of the Mid-Oceanic Ridge is shown in Figure 80. The ridge’s temperature generally increases with

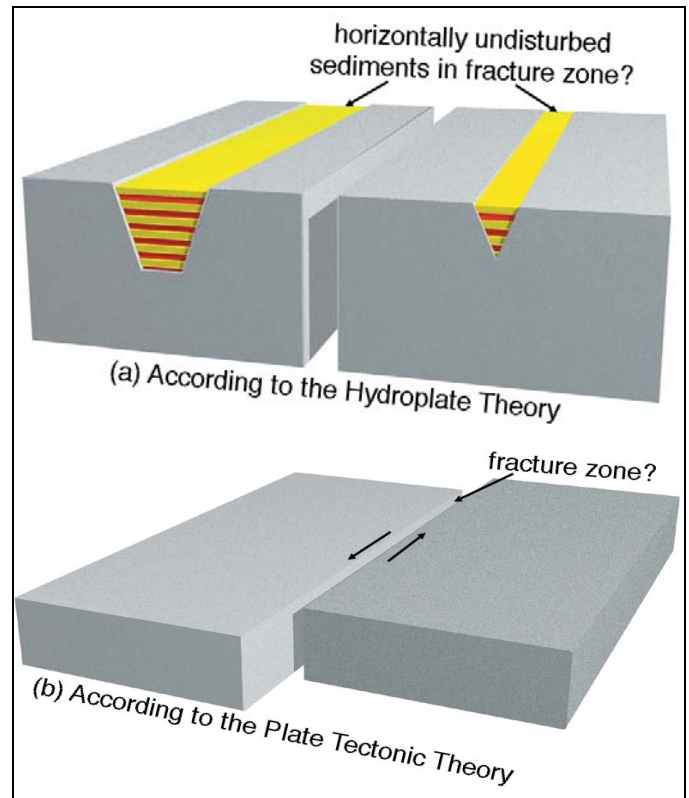

Figure 79: Two Possible Cross Sections of Fracture Zones. Figure 45’s description on page 113 explains why fracture zones have less mass along their lengths. Water-saturated sediments, shown in red and yellow layers in Figure (a) above, are much less dense than the crystalline rock below the ocean floor. Therefore, only Figure (a) explains the large absence of mass along fracture zones.

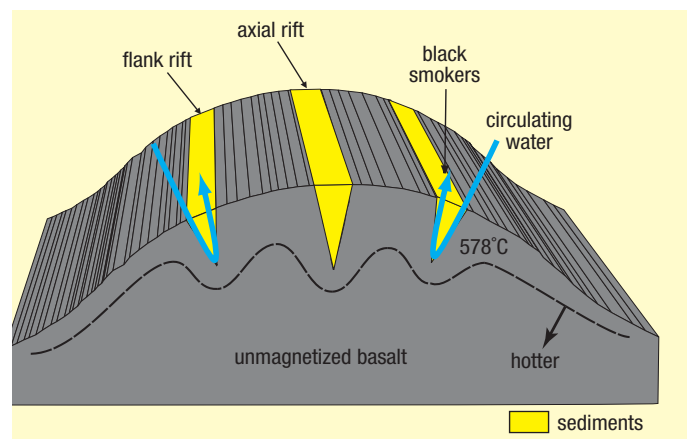

Figure 80: Curie Point under the Mid-Oceanic ridge.

depth. However, the walls of the cracks in the Mid-Oceanic Ridge are cooled by cold water circulating down into and up out of them by natural convection. After several thousand years of cooling, the constant temperature line corresponding to the Curie point is shown by the dashed line. As a rock particle cools from 579°C to 577°C, for example, it takes on the magnetism of the Earth’s magnetic field at that point. Therefore, more magnetized material lies between each crack. Magnetic anomalies also occur *perpendicular to the ridge*, along fracture zones. According to plate tectonics, such perpendicular magnetic anomalies should not exist.

Naturally, if a device measuring magnetic intensity (a *magnetometer*) is towed across the ridge, it will show the magnetic anomalies of [Figure 48 on page 115](#). These magnetic anomalies, however, are not magnetic reversals.



PREDICTION 6: Fracture zones and axial and flank rifts will always be along lines of high magnetic intensity.



PREDICTION 7: The magnetic intensity above black smokers slowly increases because the rock below, fractured since the flood a few thousand years ago, is cooling.

78. Other factors complicate the movement.

- i. The rupture didn't necessarily widen by the same amount all along its path.
- ii. The Mid-Oceanic Ridge, especially in the Pacific, would not exactly follow the path of the rupture.
- iii. A large plate moving over the Earth's surface is actually part of a spherical shell rotating about an imaginary axis passing through the center of the Earth. Points on the plate far from the poles of that axis move farther and faster than those near the poles.
- iv. Depending on exactly where the Mid-Atlantic Ridge began to rise, the hydroplates would not necessarily slide perpendicular to the entire Mid-Atlantic Ridge. In fact, the Americas Plate rotated about 10° clockwise during its slide, and the European-Asian-African Plate rotated about 10° counterclockwise. (This implies that the Mid-Atlantic Ridge began to rise south of the centers of mass of each hydroplate, very near the present equator.)

79. See [“Highly Compressed Solids” on page 608](#).

80. Some geologists have wondered if quartz migrated out of the black rock. One look at the sharp boundary between the light veins and dark host rock should eliminate that possibility. Also, quartz is the first common mineral to melt as rock heats up and the last to solidify as it cools.
81. Shearing forces would produce fairly smooth, straight crack patterns, not the “tangled” patterns at the Black Canyon of the Gunnison. Other forces (viscous, thermal, gravitational, electrical, and magnetic stresses) can be eliminated on other grounds. Because few would even entertain them as a means of breaking so much rock, we will not discuss them here.
82. In 1749, Pierre Bouger discovered that the Andes Mountains did not gravitationally attract a plumb bob as much as expected. In 1854, a similar discovery was made concerning the Himalayan Mountains. Geologists then realized that some mass is missing beneath mountains. Since then, more precise measurements on many mountains have confirmed this.
83. *“A layer of aqueous fluids could produce the conductance observed in Tibet with a lower fluid fraction and/or layer thickness than considered above for partial melt. For example, a layer only 1.6 km thick containing 10% of 100 S/m brine would be needed to yield the observed 10,000-S conductance.”* Wenbo Wei et al., “Detection of Widespread Fluids in the Tibetan Crust by Magnetotelluric Studies,” *Science*, Vol. 292, 27 April 2001, p. 718.



Figure 81: Fixed Spin Axis. Some have expressed surprise that the Earth's spin axis in [Figure 82B](#) would keep its north-south orientation during Earth's slow 34°–57° roll. A simple experiment demonstrates this, and shows that *one good experiment is worth a thousand expert opinions*. Drill two shallow holes on opposite sides of a croquet ball and fill both holes with lead. If the ball is spun with the lead-filled holes not at the equator, the spin axis does not change as the ball quickly rotates so the lead is at the equator. (When spinning, the white stripes reveal the orientation of the ball and axis.) However, the quickest way to understand that the Earth's spin axis would not change its orientation is to apply the law of the conservation of angular momentum. It assures us that a rigid body's spin axis will not change unless an external torque acts on the body.

- ◆ *“Our results imply that of the order of 10% volume of free aqueous fluids in the Tibetan middle crust produces the observed bright spot reflections. The presence of relatively large quantities of free aqueous fluids, presumably mostly saline supercritical H₂O, does not preclude the presence of melt but does constrain the maximum temperature at the bright spots to the wet granite solidus (about 650°C).”* Yizhaq Makovsky and Simon L. Klemperer, “Measuring the Seismic Properties of Tibetan Bright Spots: Evidence for Free Aqueous Fluids in the Tibetan Middle Crust,” *Journal of Geophysical Research*, Vol. 104, No. B5, 10 May 1999, p. 10,795.
84. As each mountain quickly rose, its distance from Earth's spin axis increased. This, in turn, increased the mountain's centrifugal force (blue arrow in [Figure 82A](#)), a force that is always directed away from and perpendicular to the spin axis. (Likewise, a rock whirled at the end of a string produces a centrifugal force that pulls the string taut.)

Part of each new mountain's centrifugal force acted tangentially to the Earth's surface and tended to roll the Earth. Because the rising mountains were scattered around the Earth, many of their “rolling” forces counterbalanced each other. However, the Himalayan Mountains and Tibetan Plateau are so massive that their effect dominates that of all other mountains. (The world's ten highest peaks relative to sea level—including Mount Everest—are part of the Himalayas.) In other words, crashing hydroplates thickened continents and created today's mountain ranges. Their net centrifugal force, and that of the massive and thickened Eurasian hydroplate, rolled the Earth so that the Himalayas moved toward today's equator.

Fortunately, the Earth's spin creates an equatorial bulge that acts like a huge gyroscope stabilizing the Earth. As the

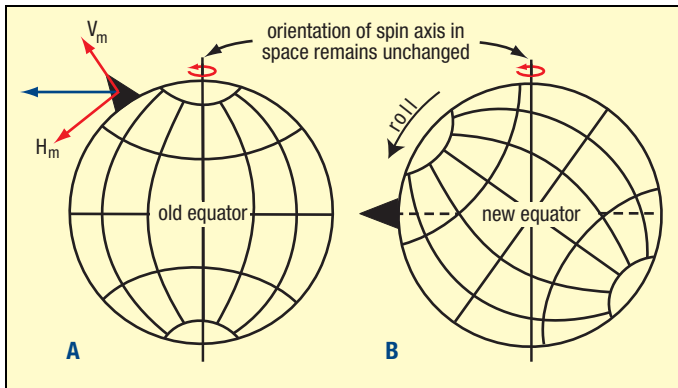
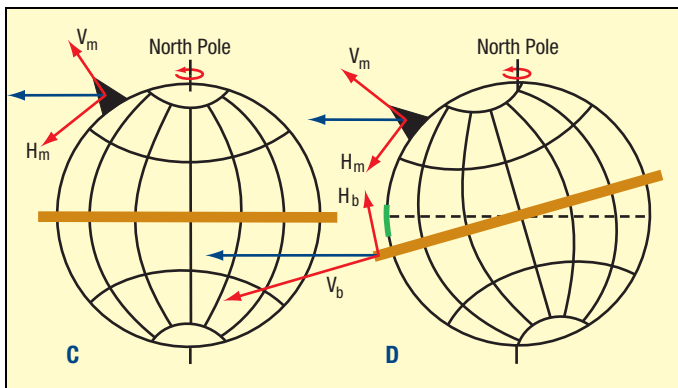

Figure 82: Earth's Big Roll. (A) If the Earth were a perfect sphere and the black mountain (black triangle) suddenly formed, the spinning Earth would become unbalanced and start "rolling" counterclockwise. This happens because a centrifugal force, shown in blue, acts on the mountain. That blue force is equivalent to the combined forces H_m and V_m (red arrows). Force H_m is always directed toward the new equator, shown in (B). The roll, which rebalances the Earth, would not change Earth's north-south spin axis or its yearly orbit around the Sun. [See Figure 81.]



(C) However, the Earth is not a perfect sphere, but has an equatorial bulge, which gives our planet great stability. We can think of the bulge as a big, brown hoop around the equator. This bulge, exaggerated above, is produced by centrifugal forces acting to deform every particle inside the Earth. (D) The more the black mountain rolled the Earth, the more the bulge tilted and the greater its force H_b became. When H_b equaled H_m in magnitude, the roll temporarily stopped. This roll angle was small, because the bulge is so much more massive than any mountain.

The equatorial bulge did not stay tipped, as shown in (D), for long. Remember, the bulge exists because every particle comprising the Earth has its own centrifugal force, which tries to move each particle as far from the Earth's axis as gravity will allow. Material inside the Earth deformed as the bulge slowly reoriented itself toward a new equator, perpendicular to the north-south spin axis. (The brown hoop can be thought of as slipping over the spherical portion of the Earth toward the new equator when H_b becomes large enough to overcome friction.) Each slight reduction in the bulge's tilt reduced H_b , so the mountain rolled the Earth another small increment—again counterclockwise. The North Pole, the point where the spin axis penetrates the Northern Hemisphere, shifted. This cycle continued at a diminishing rate until, after a few centuries and $34^\circ - 57^\circ$ of total roll, all the Earth's mass was balanced.

Because the diameter of the equatorial bulge is 26.5 miles greater than the polar diameter, the brittle crust stretched and ripped a short distance with each cycle. That rip, shown in green in Figure 82D, began slightly south of the old equator and extend north to and slightly beyond the new equator. Magma quickly flowed up into this rip, which eventually grew 3,000 miles long and is today called *Ninety East Ridge*. It is inclined 6° to longitude 90°E and can be seen in Figure 44 on page 112. Notice how *Ninety East Ridge* points toward the Himalayas, Earth's dominant mountain range, represented by the black mountain in (A)–(D). The rip at 90°E longitude reduced the stress that was tending to cause a similar rip on the opposite side of the Earth.

Earth began a slight roll immediately after the compression event, the equatorial bulge also rotated, so it was no longer perpendicular to the spin axis. The more the bulge rotated, the more its centrifugal force resisted the rolling force due to the Himalayas and the thickened Eurasian hydroplate. (Please study all of Figure 82.)

The liquid outer core partially isolated the solid inner core from this slow $34^\circ - 57^\circ$ roll. However, as the outer Earth slipped over the outer core, the core applied a torque on the outer Earth from inside. The law of conservation of angular momentum required the outer Earth's spin axis to precess, with the North Pole in Figure 82C precessing "into the page." (The last paragraph in Figure 82 explains the 6° precession that George Dodwell, in the 1930s, discovered by painstakingly analyzing almost 100 ancient astronomical measurements. See "Earth Roll" on page 136.)

The law of the conservation of angular momentum also requires that the total angular momentum of the entire Earth remain constant. Therefore, as the outer Earth (the crust, mantle, and to a large extent the liquid outer core) rolled and precessed, the solid inner core had to role and precess in the opposite direction—but more than a thousand times faster. This was because the inner core's moment of inertia is less than one thousandth of that of the outer Earth. So, the outer Earth and the inner core developed different spin orientations soon after the compression event. This difference gradually diminished as the liquid in the outer core transmitted torque between the two spinning bodies (the inner core and outer Earth).

The precession, when viewed from above the Indian Ocean, very slowly shifted the Northern Hemisphere to the west and the southern hemisphere to the east. Consequently, that rip has a slight curvature and is not a perfectly straight line. As the rip progressed northward, it curved slightly to the east. This curvature can be seen on very accurate maps of the Indian Ocean floor. For example, Google Earth shows the slight curvature not only at *Ninety East Ridge* but also along parallel stress fractures east of *Ninety East Ridge*.

The following chapter (pages 153–192) explains why the Earth's magnetic field emanates from the inner core. Therefore, the initial precession of the inner core probably produced the rapid drifting of the Earth's magnetic field described on page 115. The rate of this reverse precession has greatly diminished, but it is probably seen in today's slight westward drift of the Earth's magnetic field, the so-called *secular variation of the magnetic field*.

Earth's slow roll after the flood steadily changed the paths of the Sun and stars across the sky. That no doubt alarmed the survivors of the flood that had occurred in 3290 B.C. [See p. 484.] Attempts to measure those alarming irregularities led to the construction of Stonehenge, an ancient observatory built between 3000–2480 B.C., 90 years after the flood. [See "Stonehenge Remains Hail from Wales," *Science*, Vol. 361, 10 August, p.536.]

Besides pushing up mountains, the crashing hydroplates crushed and thickened continents, especially in weak regions. Each plate moving on the surface of a sphere has an *axis of rotation*. Because the driving forces that moved the two largest hydroplates came from the sudden upbuckling of the same

ridge (the Mid-Atlantic Ridge), both hydroplates had almost the same axis of rotation. The fastest plate movement and the most thickening would have occurred near the equator of that axis of rotation. After the compression event, centrifugal forces rolled the temporarily out-of-balance Earth, so the axis of plate rotation approximately aligned with Earth's spin axis. Therefore, today's equator approximately bisects and is perpendicular to the Mid-Atlantic Ridge. Since the compression event, isostatic adjustments have smoothed out the Earth's surface to some extent, but imbalances and adjustments—such as earthquakes—continue within the Earth.

85. As explained in Figure 82, the Himalayas (centered today at 89°E, 33°N) was somewhat south of the old North Pole but near what is now 89°E longitude. Therefore, the Himalayas could have rolled south by as much as 57° (90 – 33 = 57). However, the Himalayas had to roll at least 34° south to shift what is now the southern extreme of Ninety East Ridge (85°E, 34°S) over the equatorial bulge along 90°E longitude. So *after the compression event, but before the big roll*, the North Pole would have been somewhere on the great-circle segment joining 85°E, 56°N and 89°E, 33°N—basically central Asia.

Ninety East Ridge is a tension fracture from the crust being stretched east and west as it shifted over the equatorial bulge. Today, this stretching may continue and explain why one of the largest earthquakes in recent years occurred near that point on 26 December 2004, causing a tsunami that killed over 230,000 people. The flood is still producing death and destruction. Indeed, *all earthquakes, tsunamis, and most other natural disasters are a consequence of the flood.*

Just as the Earth roll produced stretching and tearing along Ninety East Ridge, it produced compression and buckling near both poles. At the South Pole, that compression buckled the crust downward, forming a long basin which holds a 76-mile-long subsurface (*unfrozen*) lake, appropriately named “90°E Lake.” Parallel and adjacent to that lake is another long, subsurface, Antarctic lake named Sovetskaya Lake. An earlier study concluded that these lakes were produced by stresses in the Earth's crust, not by glacial scouring or meteorite impacts. [See Robin E. Bell et al., “Tectonically Controlled Subglacial Lakes on the Flanks of the Gamburtsev Subglacial Mountains, East Antarctica,” *Geophysical Research Letters*, Vol. 33, 28 January 2006, pp. L02504–L02507.] Perhaps a compensating upward buckling at the North Pole produced the remarkably straight 1,000-mile-long Lomonosov Ridge.

86. William R. Hammer and William J. Hickerson, “A Crested Theropod Dinosaur from Antarctica,” *Science*, Vol. 264, 6 May 1994, pp. 828–830.
87. Allan C. Ashworth and F. Christian Thompson, “A Fly in the Biogeographic Ointment,” *Nature*, Vol. 423, 8 May 2003, p. 135.
88. Anthony R. Fiorillo et al., “Herd Structure in Late Cretaceous Polar Dinosaurs: A Remarkable New Dinosaur Tracksite, Denali National Park, Alaska, USA,” *Geology*, 30 June 2014.
89. Erin Wayman, “Camel Ancestors Lived in Arctic,” *Science News*, Vol. 183, 6 April 2013, p. 9.
90. This fossil deposit is located at 14°52'11.34"S, 74°50'06.18"W. For details, see Leonard R. Brand et al., “Fossil Whale

Preservation Implies High Diatom Accumulations Rate in the Miocene-Pliocene Pisco Formation of Peru,” *Geological Society of America*, Vol. 32, February 2004, pp. 165–168.

91. Water degrades rock to clay, either by gently acting on the rock over long time periods or by briefly acting violently—or by some combination of long time or high intensity. Here, a 260-foot-thick deposit of clay, mixed with volcanic ash and diatomaceous earth, has entombed hundreds of whales, 3,800 feet above sea level. This suggests great violence.
92. “*The most viable explanation for whale preservation seems to be rapid burial, fast enough to cover whales 5–13 m long and ~50 cm thick within a few weeks or months, to account for whales with well-preserved bones and some soft tissues. Such burial requires diatom accumulation rates at least three to four orders of magnitude faster than is usual in the ocean today—centimeters per week or month, rather than centimeters per thousand years.*” Brand et al., p. 167.
93. Smithsonian and National Geographic have sent teams to study this fossil graveyard at 27°03'13.72"S, 70°48'09.13"W. After a year of study, and recognizing the global importance of this site, the researchers admitted they are puzzled.
94. This burial site is only 150 feet above sea level, but some water and animals would have drained from as high as the top of the Andes—22,000 feet above sea level—down narrow ravines and into and out of depressions (temporary ponds).
95. Why are the fossilized whales mostly baleen whales? Baleen whales take large gulps of food and water, and then expel the water through filters in their mouths called *baleen plates*. If the water was thick with diatomaceous earth and other sediments stirred up by water flowing off a rapidly rising mountain during the compression event, those filters would tend to clog up, so the baleen whales would choke and die.
96. Kenneth M. Reese, “Workers Find Whale in Diatomaceous Earth Quarry,” *Chemical and Engineering News*, Vol. 54, 11 October 1976, p. 40.
- On 7 April 1986, I contacted Lawrence G. Barnes of the Natural History Museum of Los Angeles County, the scientist who excavated this fossilized whale from a quarry for diatomaceous earth. He said the whale was lying parallel to strata that had been tipped up 60° from the horizontal. Only the front half of the whale was recovered. At the time, it was stored in a warehouse and had not been cleaned up. He also saw other whales in the quarry along with a small seal, fish, and birds. The quarry, elevation 238–530 feet above sea level, is at 34°37'30.40"N, 120°29'01.79"W.
97. Obviously, the whale was rapidly and catastrophically buried in an approximately horizontal position; then those layers and the whale were tipped up by 60°. This is completely consistent with the compression event. Richard H. Tedford and C. Richard Harington, “An Arctic Mammal Fauna from the Early Pliocene of North America,” *Nature*, Vol. 425, 25 September 2003, pp. 388–390.
98. L. David Mech, “Life in the High Arctic,” *National Geographic*, Vol. 173, June 1988, p. 757.
99. A. Hope Jahren, “Humidity Estimate for the Middle Eocene Arctic Rain Forest,” *Geology*, Vol. 31, May 2003, pp. 463–466.

- ◆ See also Endnote 15 on page 141.
100. Charles Berlitz, *The Lost Ship of Noah: In Search of the Ark at Ararat* (New York: G. P. Putnam's Sons, 1987), p. 126.
 101. David Warner Mathisen, *The Mathisen Corollary* (Paso Robles, California: Beowulf Books, 2011).
 102. When stocking Lake Titicaca with trout in 1939, officials noticed the presence of *Orestias*, a genus of killifish. How did killifish get into such a remote lake, 2.3 miles above sea level—naturally, or by man? Humans have little desire for killifish for food or sport. Besides, men would have difficulty keeping any fish or their eggs alive while transporting them by foot from some distant source to Lake Titicaca. Did the fish swim there? Hardly. Because of strong winds, intense sunshine, and low atmospheric pressure, 95% of Lake Titicaca's water leaves by evaporation. Only 5% trickles into a distant, shrinking, brackish lake with no outlet to the sea. Evidently, Lake Titicaca rose along with the Andes. Did this happen thousands or millions of years ago? Knowing how rapidly environments can change and destroy habitats, one would be wise to bet on a recent date.
 103. For details, see William Ryan and Walter Pitman, *Noah's Flood* (New York: Simon & Schuster, 1998). These authors correctly conclude that the Mediterranean Sea breached its boundary, carved the Bosphorus and Dardanelles Straits, and flooded the shores of the Black Sea—which was previously predicted and explained by the hydroplate theory. [See prediction 5 on page 140. "*The channel cut through bedrock*" and formed a "*gorge more than 350 feet deep*" (p. 65). Ryan and Pitman incorrectly conclude that this led to the "myth" of Noah's flood. Instead, the local flood they discovered around the Black Sea was a *consequence* of the global flood, and bears no resemblance to many details in famous flood legends, secular or otherwise. Nor would any *local* flood explain the uncanny similarity of flood stories in almost every ancient culture *around the world*. A global flood does. Furthermore, a child could have walked away unscathed from Ryan and Pitman's flood, which they admit rose only 6 inches a day. No doubt, the Middle East has experienced many local floods. Why pick one and claim that it led to the world-famous story of Noah's flood?
 104. A buried, 125-mile-long, 650-foot-deep channel across the Gibraltar Strait shows that the Atlantic Ocean spilled into the Mediterranean Basin at 1,000 times the flow rate of the Amazon River. [See D. Garcia-Castellanos et al., "Catastrophic Flood of the Mediterranean after the Messinian Salinity Crisis," *Nature*, Vol. 462, 10 December 2009, pp. 778–781.]
 105. Aaron Micallef, et al., "Evidence of the Zanclean Megaflood in the Eastern Mediterranean Basin," *Scientific Reports*, Vol. 8, 18 January 2018, pp. 1-8.
 106. Corings into the portion of the Mid-Oceanic Ridge beneath the Arctic Ocean have revealed ferns and algae that required these warm temperatures.
 - ... extremely warm polar temperatures indicate that, despite much recent progress, feedbacks responsible for early Palaeogene mid- to high-latitude warmth remain poorly understood and are not implemented in existing climate models. Appy Sluijs et al., "Subtropical Arctic Ocean Temperatures during the Palaeocene/Eocene Thermal Maximum," *Nature*, Vol. 441, 1 June 2006, p. 612.
 - ◆ Chert forms when silica precipitates from sea water. The ratio of oxygen-18 to oxygen-16 in chert indicates that the water temperatures were once as high as 60-80 degrees C. This is confirmed independently by silicon isotopes ratios as well. [See Christina L. De La Rocha, "In Hot Water," *Nature*, Vol. 443, 26 October 2006, pp. 920–921.]
 107. An "El Niño" is the sudden warming of waters in the western Pacific. Today, it occurs every few years and alters climate worldwide, especially precipitation rates.

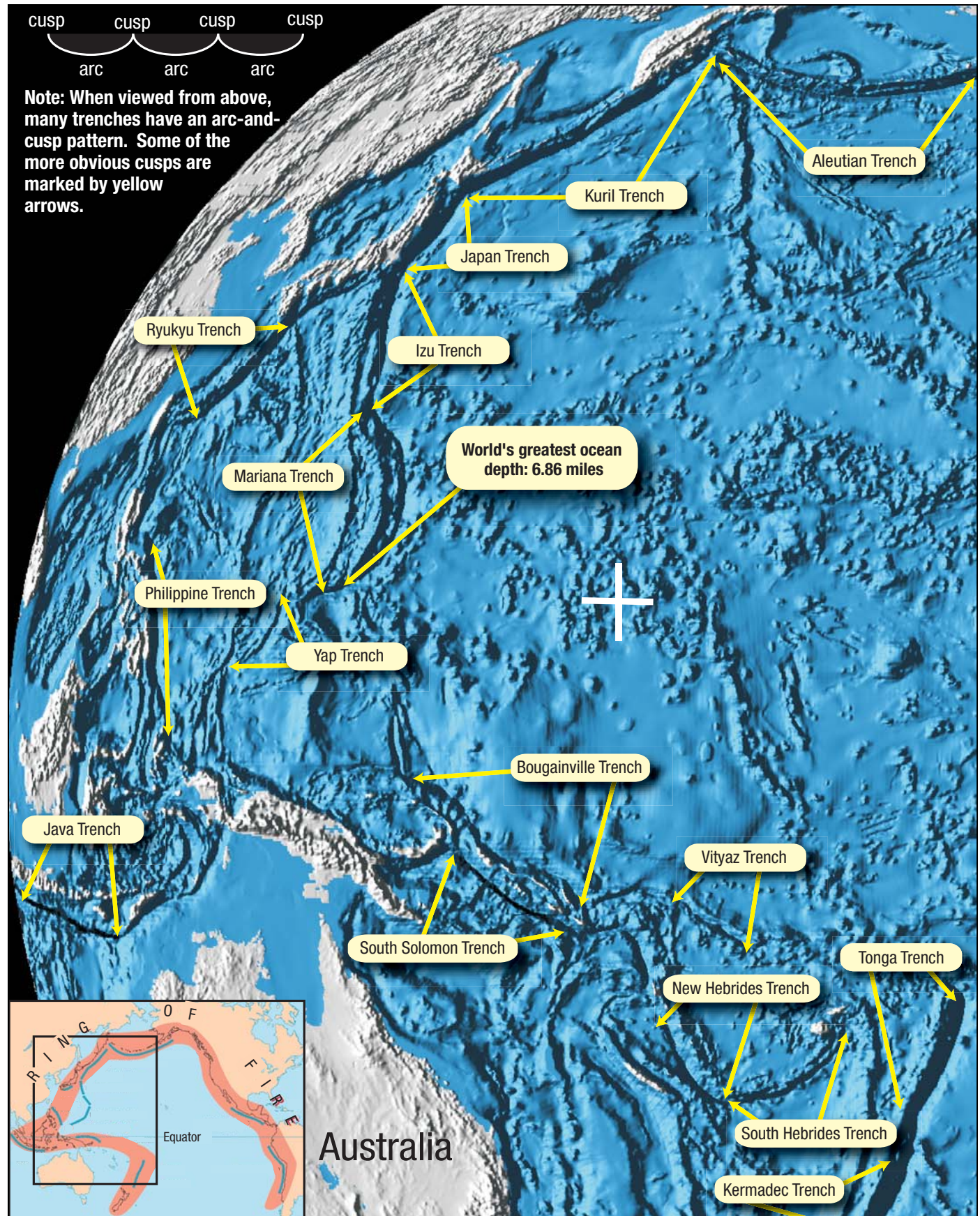

Figure 83: Trenches of the Western Pacific. Sixteen ocean trenches are concentrated in the western Pacific. Four others are located elsewhere.¹ The area above, with 40,000 volcanoes taller than 1 kilometer, has obviously been greatly disturbed. The white cross marks the center of this concentrated trench region. Visualize Earth as a sphere, not a flat map. Why is the center of this trench region almost exactly opposite the center of the Atlantic Ocean, both in latitude and longitude? The inset map shows a few trenches in green and, in orange, the Ring of Fire—a band of extreme volcanic and earthquake activity.

The Origin of Ocean Trenches, Earthquakes, and the Ring of Fire

SUMMARY: Ocean trenches, some thousands of miles long and several miles deep, lie on the floor of the western Pacific, directly opposite the center of the Atlantic. The plate tectonic theory claims that plates, drifting on the Earth's surface, dive into the Earth and form trenches. Seventeen reasons will be given why this is incorrect.

The flood began with a rupture of the Earth's crust that raced around the globe in about 2 hours. For months, escaping subterranean water eroded the rupture to an average width of about 1,400 miles all along its 46,000-mile path—even on Earth's Pacific side. The hydroplates were no longer prevented from moving at least a few hundred miles toward the Pacific side of the Earth.

Near the end of the flood, a “tipping point” was reached. So much mass had been removed from the Atlantic side of the Earth that the Mid-Atlantic Ridge started to buckle up. Hydroplates began sliding downhill on the remaining subterranean water, away from the rising Mid-Atlantic Ridge. This steadily removed gigantic amounts of weight from what would become the Atlantic floor, so the ridge and chamber floor rose even faster. Material within the Earth then had to shift toward the Atlantic side. Near the center of the Earth, where pressures are greatest and movement was most constricted, that shifting produced so much frictional heat that the inner Earth melted and shrank. (Magma is much more compressible than solid rock,² as explained on pages 156-157.) Thus the center of the Earth began its transformation into what is today's inner and outer core. Further shrinkage in the inner Earth caused the Pacific crust, surrounded by what is now called the Ring of Fire, to begin sinking. Portions of the Pacific crust directly opposite the center of the rising Atlantic floor buckled inward, forming trenches. In less than a day, the Pacific plate subsided at least 30 miles—enough to remove any obstacle to the hydroplates sliding away from the Mid-Atlantic Ridge.

Weeks later, the oceanic ridge that began rising in the Atlantic had extended to the Pacific side of Earth. After many years, gravity squeezed the Earth back toward its nearly spherical shape. Mass imbalances remain, so earthquakes now occur, and continents sporadically shift—not drift—toward the trench region of the Pacific.

Drifting vs. Shifting

The distinction between drifting and shifting is subtle but important. A box *drifts* on the sea, but a box *shifts* on a ship's deck. Drifting is a continuing movement on or in a fluid, often for a great distance, while shifting is usually a slight, but limited, lateral movement on or in a solid. Drifting is caused by a steady, unyielding, outside force, while shifting is typically caused by gravity and a change in equilibrium. Drifting requires a continuing energy source, but shifting requires a disturbance. The plate tectonic theory says that crustal plates drift very slowly for hundreds of millions of years. The hydroplate theory says crustal plates drifted very rapidly for hours on a layer of escaping, high-pressure water near the end of the flood. This drifting produced imbalances. Since then, these and other imbalances caused by the flood sporadically *shift* continents and everything below.

Imagine standing at the edge of a vast depression that reminds you of the Grand Canyon, but this depression is several times deeper. Its smoother walls are almost as steep as the Grand Canyon's, but the view across the 60-mile-wide depression is never obstructed by intermediate land forms. This “canyon,” thousands of miles longer than the Grand Canyon, does not have sharp turns. Such depressions, called **ocean trenches**, would be the leading natural wonders of the world if water did not hide them. (Average ocean depth is 2.5 miles; the deepest trench reaches 6.86 miles below sea level.) Why are sixteen trenches concentrated on the western Pacific floor?

Surprisingly, trenches contain shallow-water fossils.³

*Materials [like fossils] which are usually supposed to be deposited only in shallow water have actually been found on the floor of some of the deep trenches.*⁴

Why are such unlikely fossils in a remote part of the ocean—a thousand times deeper than one would expect?

Today, most of the Earth's crust is vertically balanced, like blocks of ice floating in a pan of water. Less dense blocks “float” higher up than denser blocks. This is called

isostatic equilibrium. However, ocean trenches are Earth's most glaring departure from this equilibrium. This imbalance may be an important clue for how trenches formed. As various authorities have written:

... trenches are characterized by large negative gravity anomalies. That is, there appears to be a mass deficiency beneath the trenches, and thus something must be holding the trenches down or else they would rise in order to restore isostatic equilibrium.⁵

The most striking phenomenon associated with the trenches is a deficiency in gravity ... Measurements of gravity near trenches show pronounced departures from the expected values. These gravity anomalies are among the largest found on Earth. It is clear that isostatic equilibrium does not exist near the trenches. The trench-producing forces must be acting ... to pull the crust under the trenches downward!⁶

In a modeling study [of the deepest ocean floor], the team reproduced the Challenger Deep's topography and fissure pattern only after factoring in a massive and mysterious downward force tugging at the Pacific Plate.⁷

You now know what that mysterious force was. Simply put, *trenches were pulled down, not pushed down*. Today, the downward pull of gravity in and above trenches is less than expected even after adjusting for the trench's shape and depth, so less mass exists under trenches than one would expect. It is as if something deep inside the Earth "sucked" downward the material directly below trenches. This would reduce the mass below trenches. (If you want to show a slight weight loss, weigh yourself while sailing over a trench.)

A useful illustration is to think of a slight vacuum, or reduced mass, under trenches—much like a partial vacuum, which "nature abhors." That is, nature always tries to move material to fill a vacuum. If one waited long enough, material inside the Earth would flow in under trenches to fill this "partial vacuum." Today, crustal plates move an inch or so each year toward trenches, so this "partial vacuum" is slowly being filled in modern times. Later, we will see where the missing mass under trenches went and what created the "partial vacuum." Clearly, this "filling in" has not been going on for millions of years.

A technique called *seismic tomography* has shown that rock in the upper mantle is denser under continents than under oceans. The technique uses earthquake waves to "see" inside the Earth, just as a CAT scan uses x-rays from many angles to "see" inside your body. Each earthquake radiates waves through the Earth. Knowing the precise time of an earthquake and the times the waves reach seismometers around the world, scientists can calculate each wave's average velocity along a specific path. After many earthquakes and knowing the velocities along thousands of different paths, a computer can estimate the wave speed at every point inside the Earth. Higher speeds



Figure 84: Spin. A spinning object, such as a figure skater or the Earth, spins faster if it becomes more compact about its spin axis. This skater starts a spin with outstretched arms. Then, as she pulls her arms in near her spin axis, she spins so fast she becomes a blur.

Gravity tries to make the Earth as compact and round as possible. Earthquakes cause the Earth to become more compact and spin slightly faster.⁸ Therefore, the further back in time we look, the less compact we should find the Earth, at least until we arrive at the time the out-of-balance condition arose. Because earthquakes can occur deep within the Earth, the out-of-balance condition affected the entire Earth and, as you will see, produced trenches and the Ring of Fire.

imply colder, or denser, rock. Earthquake waves travel faster under continents. Some increases in speed are too great to be caused entirely by colder temperatures.⁹

Earthquakes. The major goal of earthquake research is to predict earthquakes. Normally, the best way to predict something is to understand how it works. Because, earthquakes are poorly understood, much effort is spent studying events that sometimes seem to precede earthquakes—*earthquake precursors*, such as strange animal behaviors, abrupt changes in water levels in wells, swelling of the ground, and sudden irregularities in local geyser eruptions.

Plate tectonic theory claims that earthquakes occur when plates rub against each other, temporarily lock, and then jerk loose. If so, why are some powerful earthquakes far from plate boundaries?¹⁰ Why do many earthquakes occur when water is forced into the ground?¹¹ Following the 2004 Sumatran earthquake and tsunami that killed 230,000 people, why was there a permanent drop in the pull of gravity below the epicenter? According to plate tectonics, the mass should not have changed. This was measured very precisely by the GRACE satellite system.¹²

A fault is a fracture in the Earth's crust along which movement has occurred. During most earthquakes, opposite sides of a *preexisting* fault "unlock" and suddenly slip. If the side of a fault nearest a distant seismometer moves toward the seismometer, a compression wave will be detected first. If that side moves away from the seismometer, a tension wave will be detected first. By examining the first wave to reach many seismometers, one can deduce the orientation of the fault plane and whether the earthquake was triggered by compression or tension. *Earthquakes near a trench are almost always due to horizontal tension perpendicular to the trench axis—not compression as predicted*

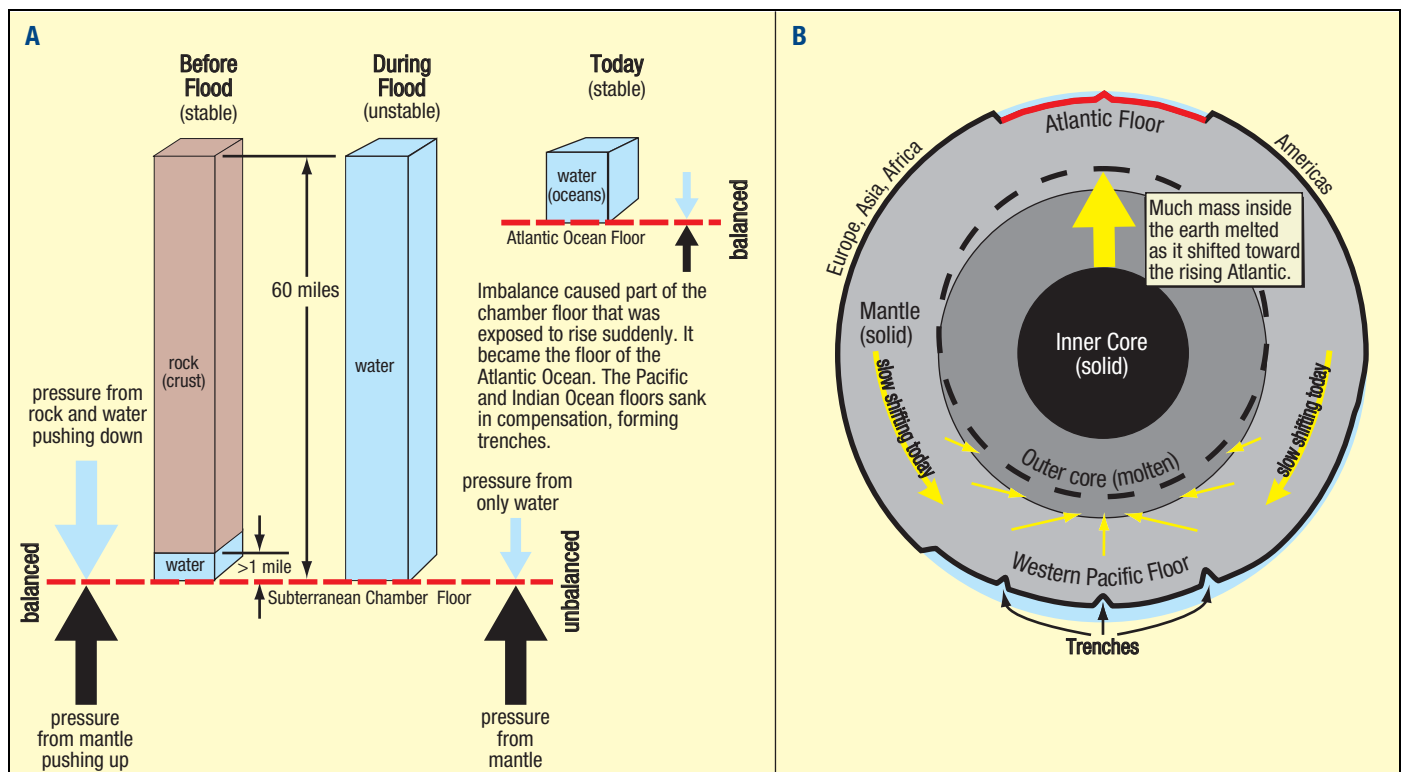

Figure 85: Hydroplate Explanation for Trenches. (A) Before the flood, the weight of rock and water, pushing down on the subterranean chamber floor, balanced the floor's upward pressure. The rupture destroyed that equilibrium. Directly below the rupture, the imbalance grew as escaping, high-velocity water and the 60-mile-high, unsupportable, crumbling walls widened the globe-encircling rupture hundreds of miles. Eventually, the imbalance overwhelmed the strength of the floor. First, the Mid-Atlantic Ridge buckled, or sprang, upward. Then, as Europe, Africa, and Asia slid eastward and the Americas plate slid westward (based on today's directions), weight was removed from the rising floor, so it rose faster, accelerating the hydroplates even more. Pressure directly under the floor, represented by the large black arrows, naturally decreased as the floor rose.

(B) During the flood phase, the escaping subterranean water eroded and thinned the pre-flood crust to a thickness of about 30 miles. Frictional heating from movements near the center of the Earth began melting solid rock which then contracted, because of the extreme pressure and magma's great compressibility, contracted, as explained in "**Magma Production and Movement**" on pages 156–157. This caused the crust on the Pacific side of the Earth (*the Pacific plate*) to subside by at least 30 miles, fracturing the Pacific plate at thousands of places within the boundaries of the Ring of Fire!¹³ That drop steepened the downhill slope of the sliding hydroplates, allowing them to slide into the Pacific region without major obstructions. Downward buckling and deep faulting formed trenches. All this melting lubricated the shifts inside the Earth and allowed gravitational settling, which released much more heat, increased Earth's spin rate, and converted the inner Earth to today's inner and outer core—monumental changes. The thick layer of magma expelled up onto the top of the sunken Pacific plate provided most of the heat that drove the ice age and accounts for the almost 40,000 volcanoes on the Pacific floor. Even today, magma sometimes breaks out and escapes upward, heating part of the ocean and creating "El Niño" weather conditions.¹⁴

by plate tectonics.¹⁵ Measurements also show that micro-earthquakes on the ocean floor tend to occur at low tide.¹⁶

But some earthquakes are "slow"—very slow. Every year or so, *slow-slip* occurs along some faults, moving the ground horizontally inches per week, rather than feet per second, as in a normal earthquake. Slow-slip is often accompanied by tremors, detectable only on seismometers. *Sometimes this slow-slip mysteriously reverses direction!*¹⁷

Shallow earthquakes sometimes displace the ground horizontally along a fault, as occurred along the San Andreas Fault during the great San Francisco earthquake of 1906. Western California slid northward relative to the rest of North America. The San Andreas Fault has several prominent bends, so just as two interlocking pieces of a jigsaw puzzle cannot slip very far relative to each other,

neither can both sides of the curved San Andreas Fault. Furthermore, if slippage has occurred along the San Andreas Fault for eons, friction should have greatly heated the sliding surfaces. Drilling into the fault has not detected that heat.¹⁸ Evidently, little movement has occurred over millions of years or the walls of the fault were lubricated. Maybe both.

Almost 90% of all earthquake energy is released under trenches. Earthquakes often occur near planes, called *Benioff zones*, that slope downward from trenches at 30°–60° angles below the horizontal. These earthquake zones extend to depths of about 410 miles.

A prominent feature on all ocean floors is the Mid-Oceanic Ridge. One characteristic of the ridge figures prominently in two competing theories for how trenches formed. As explained in the preceding chapter, the ridge is cracked in

Magma Production and Movement

Magma's Compressibility. Magma (melted rock inside the Earth) is more compressible than the solid rock from which it came.² Rock that melts under the extreme pressures more than 220 miles below the Earth's surface will contract! At depths of about 220 miles, melted rock occupies nearly the same volume as the original rock. At atmospheric pressure, rock expands by 7–17% (depending on the minerals present) when it is heated and melts. The density where the rock's volume does not change as it melts is called the *crossover density*. Again, it depends somewhat on the minerals present. Because of magma's compressibility, *magma below this depth of about 220 miles is too dense to rise, so magma cannot circulate inside the mantle,*¹⁹ *contrary to what has been taught for 50 years!*

Nor was the mantle ever molten, because it would have expanded as it solidified, placing Earth's crust in such extreme tension that it should have many mile-deep cracks.²⁰

Earth's magma began to be produced during the flood. [See “**Melting the Inner Earth**” on pages 603–606.] The magma's final volume was more than 120 times greater than all the water in today's oceans! With so much more liquid rock inside the Earth than liquid water on Earth, we need to understand how magma forms and why it moves.

Where Did All the Magma Go? The denser (deeper) magma and the denser unmelted minerals in the magma slowly drained into what grew to become Earth's outer and inner cores, respectively. The less dense magma that formed above the crossover depth tended to escape upward to the Earth's surface as volcanoes or flood basalts. For years after the flood, most eruptions spilled onto the Pacific floor—a floor littered today with 40,000 volcanic cones, each taller than 1 kilometer! The following analogy explains why.

A Cable Analogy. Imagine a long, unbreakable cable passing through the center of the Earth before the flood. One end is anchored to the portion of the subterranean chamber floor that will rise to become the floor of the Atlantic Ocean. The other end attaches to the Pacific plate on the opposite side of the Earth. When the Atlantic floor is forced upward at the end of the flood, the Pacific floor will be pulled down.

Gravity produces the same effect as our imaginary cable. Gravity creates so much compression deep inside the Earth that voids cannot open up; rock is always squeezed against rock (including melted rock). However, compressed rock can shear. For example, if a heavy weight is on top of a deck of cards lying on a table, space cannot open up between the cards, but a small horizontal force can cause a lubricated card to slip (or shear) relative to an adjacent card. Friction from shearing and deformations deep in the Earth always melts the sliding surfaces. The magma produced then lubricates those surfaces, so they slip more easily.

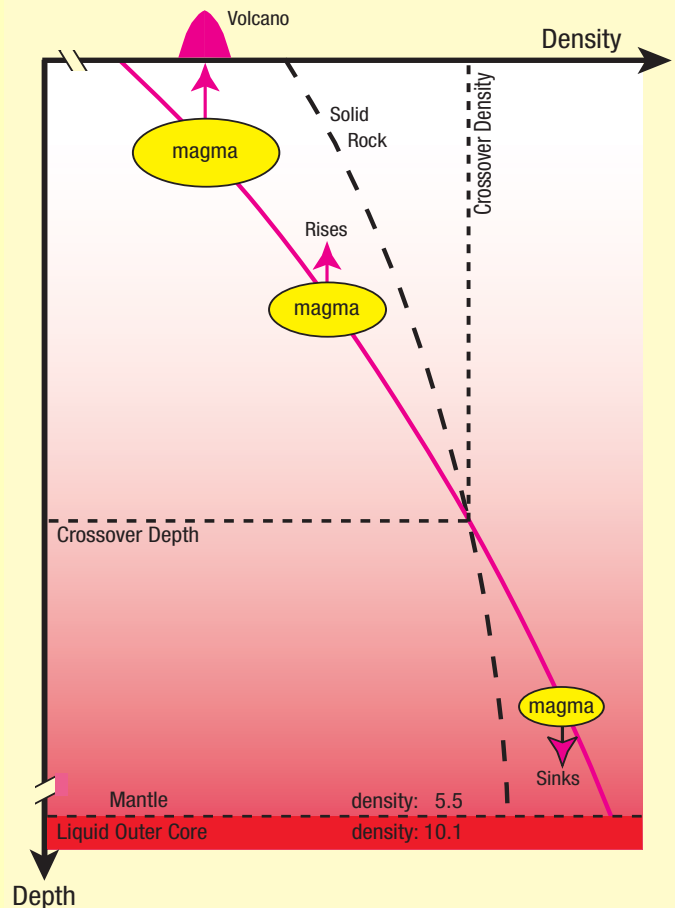

Figure 86: Crossover Depth. This graph shows how the density of liquid rock (magma) changes with depth below the Earth's surface. Above the crossover depth, magma is less dense than solid rock at the same depth and will try to rise through the cracks where the magma was produced by sliding friction; below the crossover depth, magma is denser than solid rock and will sink along those cracks toward the liquid outer core. Magma that drains down into the liquid outer core becomes almost twice as dense as the solid rock at the base of the mantle. [Note, at the bottom of the figure, the contrast in density (5.5-to-10.1) between the mantle and liquid outer core, and see the highlighted red cells on page 604.] Therefore, **the mantle cannot circulate.**

Shearing. Now let's imagine many evenly spaced cables connect the rising Atlantic floor to the broader, subsiding Pacific plate. (The upward pull from the rising Atlantic floor widens with depth;²¹ *this is why the Pacific has a larger area than the Atlantic.*) These cables shorten by varying amounts, because of variations in frictional heating along their lengths and magma's compressibility. The farther a cable segment is from the Atlantic floor, the more likely it will move at a different rate than a corresponding segment on an adjacent cable, so shearing occurs and magma is produced. Each segment's movement is the cable's net expansion (or contraction) between the segment and the Atlantic floor. Therefore, the farther a segment is from the Atlantic floor, the more likely shearing becomes. Thus, shearing and magma production are extreme in and under the Pacific plate.

Large shearing offsets that reached the Pacific floor formed ocean trenches. Benioff zones under trenches are shearing surfaces (fault planes), not subducting plates, as commonly taught.²² Island chains often formed where magma escaped upward along these cracks. The Hawaiian Islands and the Emperor Seamounts are prime examples.

Deep Movements during the Flood Phase. As subterranean water escaped during the flood phase, the rupture steadily widened. This removed more and more weight from the chamber floor directly below, so that portion of the floor increasingly bulged upward. For a while, two types of forces resisted the rising of what would become the Atlantic floor: (1) the strength of the rock between that floor and the Pacific side of the Earth, and (2) the weight of the stationary hydroplates that still lay above most of what would become the Atlantic floor.

Fractures and melting occurred deeper and deeper beneath the bulging chamber floor on the Atlantic side. Magma produced below the crossover depth contracted, so deeper fracturing, melting, and contraction occurred at an accelerating rate. By the end of the flood phase, the Pacific plate's sagging foundation had fractured in millions of places, and the magma generated along the deep sliding surfaces instantly contracted. Therefore, the Pacific plate, lacking support, rapidly subsided and sheared around its perimeter—now called the **Ring of Fire**. This shearing suddenly increased the upward pressure under the rising Atlantic floor, so the hydroplates began to accelerate away from the rising Mid-Atlantic Ridge. That also removed weight from above the Atlantic floor, so it rose even faster.

Because so much compressible magma was quickly produced under the Pacific plate, that plate subsided (caved in) *faster* than the Atlantic floor rose. In hours, the downhill slope on which the hydroplates slid steepened, and the sheared Pacific Basin, surrounded by the Ring of Fire, became so deep that the hydroplates, sliding away from the rising Mid-Atlantic Ridge, met no major obstacles.

After the flood, magma under the Pacific floor, but above the crossover depth, erupted onto the Pacific floor. (To a much lesser extent, eruptions continue today, temporarily raising ocean temperatures in the equatorial Pacific, a phenomenon called *El Niño*.¹⁴) Magma below the crossover depth drains down into the outer core, so *the outer core is slowly growing today!* Simultaneously, melting is shrinking the total volume below the crossover depth, so the crust must be compressing like the wrinkling skin of a drying (shrinking) apple. Also, continents, thickened during the compression event, are still sinking into and laterally displacing the mantle. Therefore, the mantle is being squeezed downward from above and upward by the growing outer core. Mantle volume is also being lost primarily from the Pacific mantle by draining below the crossover depth and by eruptions above the crossover

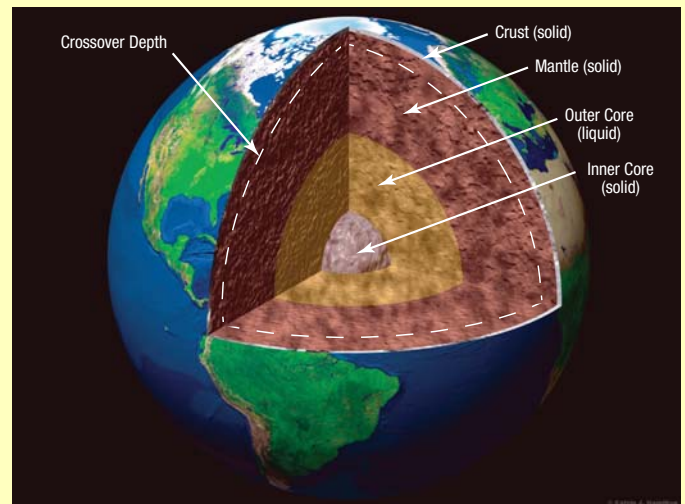

Figure 87: Inner Earth. The dashed white line marks the crossover depth. Magma generated above that line is less dense than the surrounding rock, so it will try to rise to the Earth's surface. Magma generated below that line contracts (becomes denser), so it drains through cracks into the outer core (a liquid). Standard explanations for today's shifting continents and for so much liquid 1,800–3,200 miles under our feet are full of scientific problems.²³ [See “**Molten Earth**” on page 28, and “**Melting the Inner Earth**” on pages 603–606.]

depth. Therefore, the mantle is shifting an inch or so a year, generally toward the Pacific, to replace that escaping volume. [See **Figure 94** on page 171.] These movements and stresses produce earthquakes. Slowly shifting continents led to the mistaken belief that the entire *solid* mantle somehow circulates as if it were a liquid—and, over millions of years, drifted continents over the face of the Earth.

Eniwetok Atoll. Since the flood, magma that erupted onto the Pacific floor has raised sea level relative to the subsided Pacific plate that lies a few miles below the Pacific floor. This slow rise allowed today's coral islands on top of tablemounts to grow upward—fast enough to maintain the sunlight they needed for optimal growth. The coral depth below one of these islands, Eniwetok Atoll, is 4,600 feet.²⁴

Rapid Cooling. Some claim that if magma spilled out only about 5,000 years ago, heat would still be present. The lack of heat, they assert, shows that millions of years have elapsed. They have overlooked magma's contents: (a) crystals of unmelted minerals with high melting temperatures, (b) rock fragments, called *xenoliths* (ZEN-oh-liths), dislodged by the violent shearing and crushing, and (c) water absorbed by magma rising up through what remained of the subterranean water chamber. (This is why volcanoes emit so much water vapor; typically 70% of all gas released by volcanoes is water vapor.²⁵) Because water dissolved in magma lowers its melting temperature, the magma remained a liquid at temperatures below the rock's normal melting temperature. Also, the solid rock fragments in the magma absorbed heat, so the magma quickly cooled and solidified.

a strange pattern. Some cracks are nearly perpendicular to the ridge axis, while other cracks are parallel to it. Their shapes and orientation are best explained by the stretching of the ridge.²⁶ What would stretch the ridge in two perpendicular directions? These cracks are easily seen along the Mid-Oceanic Ridge in Figure 44 on page 112.

More than 40,000 submarine volcanoes, called *seamounts*, litter the Pacific floor. Some rise higher above the seafloor than Mount Everest rises above sea level. Strangely, the Atlantic has few seamounts. If, as the plate tectonic theory claims, one plate dives (subducts) beneath another, why aren't seamounts and soft sediments scraped off the top of the descending plate?

About 2,000 *flat-topped* seamounts, called *tablemounts*, have tops that are 3,000–6,000 feet below sea level. Evidently, as these volcanoes tried to grow above sea level, wave action planed off their tops. Either sea level was once 3,000–6,000 feet lower, or ocean floors were 3,000–6,000 feet higher, or some combination of both. Each possibility raises new and difficult questions.

More than half of the world's active and dormant land volcanoes and 90% of the world's earthquakes occur along the Ring of Fire, shown in the inset map on page 152. Obviously, that 25,000-mile-long, horseshoe-shaped path is a region that was violently disturbed in the past.

From deep in the mantle, enormous amounts of melted basalt, called *flood basalts*, rapidly²⁷ spilled upward onto the Earth's crust—especially onto the Pacific Basin. Above sea level, some “spills” that we can examine today are large enough to cover the eastern United States to the height of the Appalachian Mountains—from Atlanta to New York City and from the Appalachian Mountains to the Atlantic Ocean. More than a dozen of these convulsions have occurred at different places on land, dwarfing in volume the total magma in all volcanic cones. The volume of all “spills” below sea level may be a hundred times greater.

Rocks are composed of various minerals, some containing molecules of water. These minerals are not wet to the touch, because each water molecule is locked separately in a mineral's crystalline structure, and the water occupies only about one-thousandth of the rock's volume. However, the inner Earth is so large that it probably contains several oceans' worth of water. Some heating process may have released that water, allowing it to collect in larger pockets. That would account for pooled water (*with a total volume equal to the water in the Arctic Ocean*) that is dispersed 500–750 miles under eastern Asia and part of western North America.²⁸

Theories Attempting to Explain Ocean Trenches, Earthquakes, and the Ring of Fire

Two broad theories try to explain ocean trenches, earthquakes, and the Ring of Fire: **the hydroplate theory**,

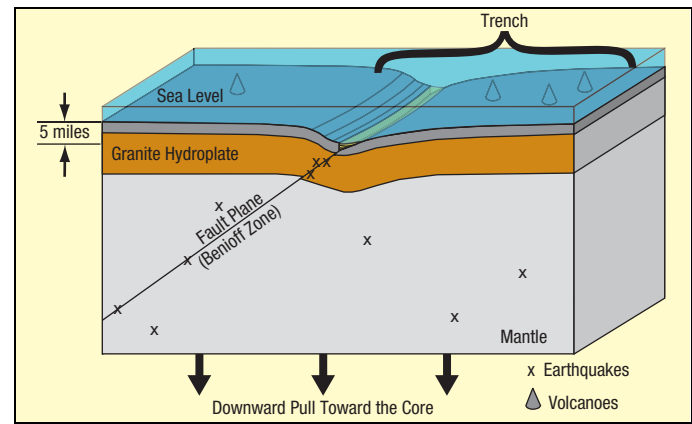

Figure 88: Trench Cross Section Based on Hydroplate Theory. Notice that the trench axis will generally not be a straight line. Sediments (green) hide the top of a fault plane that would otherwise rise a few hundred feet above the floor. Other sediments (not shown) and flood basalts (dark gray) cover most of the western Pacific floor. The three large black arrows show the direction of the rising Atlantic and the forces that downwarped the mantle and the Pacific plate. Earthquakes occur on the many faults produced, especially in Benioff zones and at low tides. Most volcanoes are not above Benioff zones, but are near a myriad of other faults near the center of the western Pacific, where there was considerable downwarping and shearing.

and **the plate tectonic theory**. Each explanation will be given as its advocates would. Then, we will test these conflicting explanations against observations and the laws of physics.

The Hydroplate Theory. [For a summary of the hydroplate theory, see pages 111–151.] At the end of the flood phase, unsupportable, crumbling walls and erosion from escaping high-velocity water had widened the globe-encircling rupture to an average of about 1,400 miles. Exposed at the bottom of this wide, water-filled gap was the subterranean chamber floor, about 60 miles below the Earth's surface. Before the rupture, the weight of rock and water pressing down on the chamber floor balanced the upward pressure directly under the floor. [See Figure 85.] Afterward, with the overlying rock suddenly gone, only the strength of the upward-bulging chamber floor and the weight of some water resisted this upward pressure. As the rupture widened, the Mid-Oceanic Ridge suddenly buckled upward. [See pages 130–136.]

The continental-drift phase began with hydroplates sliding “downhill” on a layer of water, away from the rising Mid-Atlantic Ridge. This removed more weight from the rising portion of the subterranean chamber floor, lifting it faster, and accelerating the hydroplates even more. As that part of the chamber floor rose to become the Atlantic floor, it stretched horizontally in all directions, just as a balloon stretches when its radius increases. This stretching produced cracks parallel and perpendicular to the Mid-Oceanic Ridge, forming the overlapping spreading centers shown on pages 114 and 146. Rising began in the Atlantic, so the Mid-Atlantic Ridge and its cracks are the most prominent of the oceanic ridge system.

The rising Atlantic floor pulled even deeper material upward. Within the inner Earth, material shifted toward the rising Atlantic floor, a broader, but initially shallow, depression formed on the opposite side of the Earth—the basins of the Pacific and Indian Oceans. Just as the Atlantic floor stretched horizontally as it rose, the western Pacific floor compressed horizontally as it subsided (sank).

The slope between the upward bulging Atlantic floor and the subsiding Pacific floor steadily increased. (Figure 50 on page 117 shows one small, but telling, “snapshot” of what followed.) The instability that triggered the continental-drift phase was like that of a large, flat rock resting in the center of a horizontal teeter-totter. Slight imbalances (such as variations in the width of the rupture during the flood phase and the shifting of water from the Atlantic side to the Pacific side) will slowly tip our teeter-totter. A tipping point will be reached where the rock will rapidly accelerate downhill, so the tipping will increase even more. Although the Earth departed significantly from a spherical shape, gravity restored most of that spherical shape in the following months and years.

In the western Pacific, near the center of the combined Pacific and Indian Oceans, lies the trench region. As explained on pages 156–157, material beneath the western Pacific subsided at least 30 miles,¹³ so the Pacific plate sheared and buckled downward in some places, forming trenches. The Atlantic Ocean (centered at 21.5°W longitude and 10°S latitude) is almost exactly opposite this trench region (centered at 159°E longitude and 10°N latitude). [See Figure 83 on page 152.]

A simple, classic experiment illustrates some aspects of this event.

A cup of water is poured into an empty 1-gallon can. The can is heated from below until steam flows out the opening in the top. The heat is turned off, and the cap is quickly screwed onto the top of the can, trapping hot steam in the metal can. As this steam cools, a partial vacuum forms inside the can. The can’s walls buckle inward, forming wrinkles in the metal—“miniature trenches.”

The upper 5 miles of the Earth’s crust is hard and brittle. Below the top 5 miles, the large confining pressure will deform rock if pressure imbalances are great enough.²⁹ So, as the western Pacific floor sank, it sheared and buckled into “downward creases,” forming trenches. The hard crust and deformable mantle frequently produced trenches with an “arc and cusp” shape. The brittle crust cracked and slid in many places, especially along paths called Benioff zones.³⁰

High-pressure deformations inside the Earth produced faulting and, therefore, extreme friction—and heat.

To appreciate the heat generated, slide a brick one foot along a sidewalk. The brick and sidewalk will warm slightly. Sliding a brick an inch but with a mile

of rock squarely on top would melt part of the brick and sidewalk. Earth’s radius is almost 4,000 miles. Place a few thousand of those miles of rock on top of the brick and slide it only one thousandth of an inch. The heat generated would melt the entire brick and much of the sidewalk below.

Small movements deep inside the solid Earth, even microscopic, puttylike deformations, melted huge volumes of minerals. This released the water locked within the crystalline structure of certain minerals.

Suppose the inner Earth initially had a more uniform mixture of minerals. Heating would first melt minerals with lower melting temperatures, which would allow denser grains to settle and lighter grains to rise, a process called *gravitational settling*. This would generate much more heat and produce more faulting, melting, and gravitational settling. After many such cycles, the Earth’s core would form with solid, denser minerals (containing iron and nickel) settling to form the inner core and the melt forming the liquid outer core. Shifting so much mass toward the center of the Earth and doubling the density of the rock melting below the crossover depth would increase Earth’s rotational speed, just as the skater in Figure 84 on page 154 spins faster as she draws her arms closer to her spin axis.

In the mid-1980s, seismologists noticed that seismic waves pass through the inner core about 4 seconds faster when traveling along the axis of the magnetic poles.³¹ Other tests showed that this was because crystals in the inner core have a preferred orientation.³² That direction is slowly changing by about 0.4° per year,³³ so the inner core is spinning slightly faster than the rest of the Earth.³⁴ It can do this because the liquid outer core allows slippage. “**The Origin of Earth’s Powerful Magnetic Field**” on page 180 explains how this alignment of crystals arose. Other evidence, explained in Endnote 23, supports these powerful movements inside the Earth. Today, the Earth spins 365.256 times each year, but there are historical reasons for concluding that a year once had 360 days.³⁵ [For details, see “**Melting the Inner Earth**” on pages 603–606.]

Shrinking Earth. The liquid outer core has a volume of 4.1×10^{10} miles³ (1.7×10^{11} km³)—7.7 times the volume of our moon. The outer core’s density is almost twice that of the mantle rock from which it came. Therefore, before the core formed, the preflood Earth’s volume was almost 4.1×10^{10} miles³ greater, so the Earth’s radius was about 180 miles larger than today. *The Earth shrank.*

Undoubtedly, most of this shrinkage occurred during and soon after the flood, as the mantle lost about twice the volume that the dense core gained. Earthquakes still occur, so the Earth is still shrinking, because slight amounts of relatively low density mantle rock below the crossover depth are still becoming high density magma draining into the outer core.

Forming the Core

For over two centuries, textbooks and popular media have taught that the Earth evolved by meteoritic bombardment. If that had happened, all Earth's material, falling in from outer space, would have generated enough heat to have melted the Earth several times over.³⁶ Supposedly, over billions of years, most of the Earth cooled and solidified, so only the outer core is still molten. This explanation for Earth's core has four fatal problems:

- ◆ The inner core is also a solid. For it to solidify, too much heat would have to be conducted away from the center of the Earth—a process so slow that it can be considered impossible in less than a hundred billion years.³⁷
- ◆ A molten Earth would have evaporated all Earth's water and produced a runaway greenhouse, similar to the atmosphere of Venus today. Earth's atmosphere would still be so hot that life on Earth would be impossible. [See **"Consequences of Evolving Earth by Meteoritic Bombardment"** on page 609.]
- ◆ Had the Earth ever been molten, we should not find dense nonreactive minerals (such as gold) at Earth's surface; those minerals would have settled into the core.
- ◆ Had the Earth ever been molten, siderophile (or iron-loving) elements—*found in the mantle*— would have combined with iron and have settled into the core.³⁸

Other problems with this explanation are given in **"Molten Earth?"** on page 28. So how did Earth's core form?

As the rupture widened during the flood, the floor of the subterranean chamber suddenly bulged upward under the entire length of the 46,000-mile-long rupture (as shown in Figure 63 on page 130 and Figure 65 on page 131). At the center of the Earth, where pressures are extreme and stresses and movements are focused, frictional melting began. Pressures are so great near the Earth's center that even slight movements between adjacent molecules produce heating, melting, and (as explained on page 156.) shrinkage. This was the beginning of the Earth's core.

Crystals with lower melting temperatures melted first. The magma produced then surrounded other crystals, shielding them from further shearing stresses and frictional heating. As recent discoveries have confirmed,³⁹ the denser, unmelted crystals settled through the melt, producing a solid, but squishy inner core. This is why a "giant crystal" is at the center of the Earth and why earthquake waves travel much faster through the inner core along "the axis of the magnetic poles" than in the perpendicular direction.^{31,32} Crystals less dense than the melt floated to the top of the melt and pressed against the bottom of the mantle. This is the origin of the ultralow-velocity zone, the 200-km-thick D" layer at the base of the mantle. Seismic waves travel more slowly through D", because it consists of slushy, magma-saturated sediments.

Material that melted near the center of the Earth (far below the 220-mile crossover depth) shrank, producing in

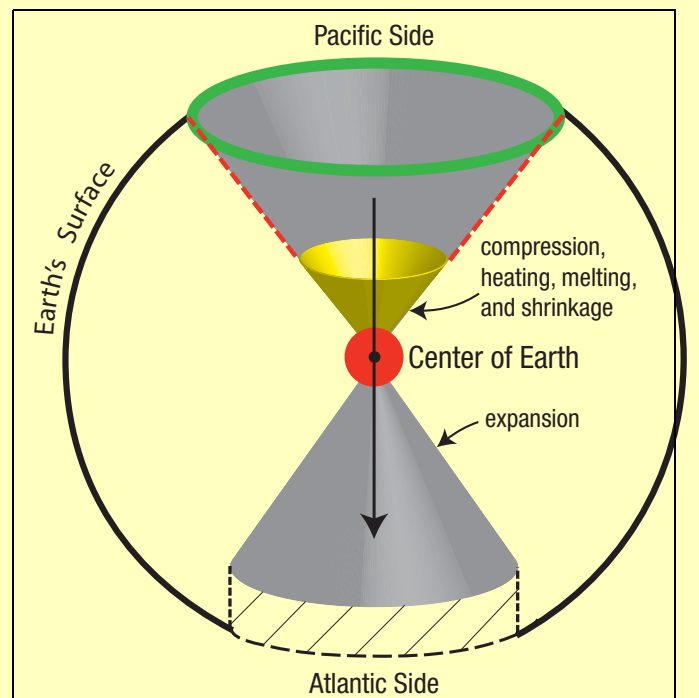

Figure 89: Concentrated Stress, Deformation, and Heating at Earth's Center. When the flood began, the fountains of the great deep steadily eroded and widened the rupture, especially in what is now the center of the Atlantic, (shown by the cross-hatched region). Eventually, weight pressing down on the center of the Earth from the Pacific side was so much greater than the weight pushing down from the Atlantic side that rock was extruded through the center of the Earth toward the Atlantic side. That rock instantly melted and shrank by about 50%, because it was so far below the crossover depth. This was the beginning of Earth's core, shown as the red circle.⁴⁰

With the collapse of the deepest foundations on the Pacific side of the Earth, a situation quickly developed in which deep shearing, frictional heating, and shrinkage produced more shearing, frictional heating and shrinkage. The shrinkage within the yellow cone region caused the sides of the gray Pacific cone (marked by the dashed red line) to shear. This produced **the Ring of Fire**, shown in green, and dropped the Pacific plate at least 30 miles. Simultaneously, the Atlantic floor rose.

In this simplified (not to scale) illustration, assume that all movement was in the general direction of the long black arrow and confined within the two gray cones whose apices met at the center of the Earth. Obviously, runaway melting began near the center of the Earth, where pressures and deformations were greatest.

the rock immediately above even more deformation and melting. For a time, runaway melting occurred, especially on the Pacific side of the Earth.

Throughout the flood, the chamber floor increasingly bulged upward, producing fractures that grew deeper as the rupture widened. Eventually, deep shear fractures connected with the growing outer core. Those drainage channels remain today allowing magma (produced below the crossover depth) to drain down into the outer core. As will soon be explained, these deep channels play a key role in earthquakes, Earth's magnetic field, and the slow shifting of the continents. Misunderstanding the cause of

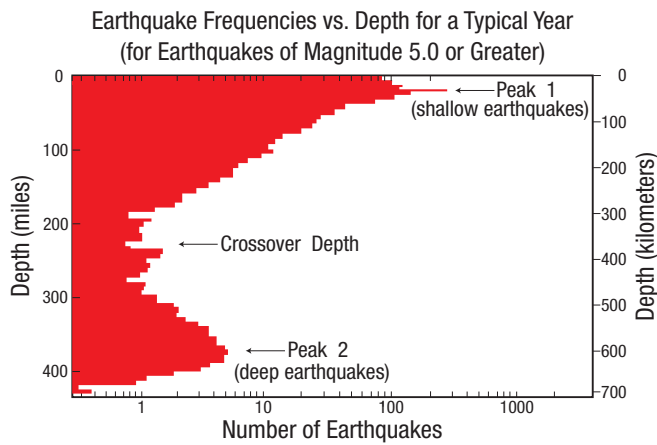

Figure 90: Earthquake Depths. Each earthquake begins at a point called the *focus*, somewhere below the Earth's surface. Wouldn't you expect that most foci lie at a certain depth, or that their numbers increase or decrease with depth? Surprise! For earthquakes with a magnitude of 5.0 or more, there are *two* peaks. In other words, *earthquake foci are bimodal with depth*.⁴¹

The fact that there are two peaks—one 22 miles (35 kilometers) below the Earth's surface and the other at 370 miles (600 kilometers) below—tells us that two types of earthquakes occur, each at a different depth. The hydroplate theory explains both conditions and why conventional geophysics does not explain the root cause of earthquakes.

Shallow earthquakes (above depths of 220 miles) involve only brittle fracture and sliding friction.⁴² However, cracks or space should not open up to allow movement for deep earthquakes where pressures are extreme. Geophysicists have tried for more than 80 years to explain why earthquakes occur at 220–410-mile depths.⁴³ Those rocks should be so hot that they would not break, but would deform like hot tar—slowly and quietly. Those earthquakes occur where pressure and heat should cause rocks to deform and flow before enough stress can build up to cause failure. **How then do deep earthquakes occur?**

Here's a clue based on the hydroplate theory. The fewest earthquakes occur at 220-mile depths—the crossover depth—because magma produced along faults at that depth has little tendency to rise or sink. Magma above 220-mile depths expands and tries to rise to the Earth's surface. Magma below 220-mile depths contracts and drains into the outer core. [Figure 91 completes the answer.]

these shifts led to the erroneous theory of plate tectonics. Can this shrinkage be measured? Marginally. Impressive measurements in changes of the Earth's radius were conducted in 2000 and 2005 by the International Earth Rotation and Reference Systems Service in Paris, France,⁴⁴ using seventy stations around the world. Those measurements (based on Satellite Laser Ranging, Very Long Baseline Interferometry, and the Global Positioning System) showed a 0.2 inch (5 millimeters) shortening of Earth's radius during those 5 years. However, more accurate techniques were used in 2005, so the shortening may be due to improved accuracy. Future measurements should clarify the amount of shrinkage.

Before plate tectonics became popular, some geologists said that many of the Earth's surface features were a result of past shrinkage deep within the Earth.⁴⁵ Among the many crustal features they felt this would explain were

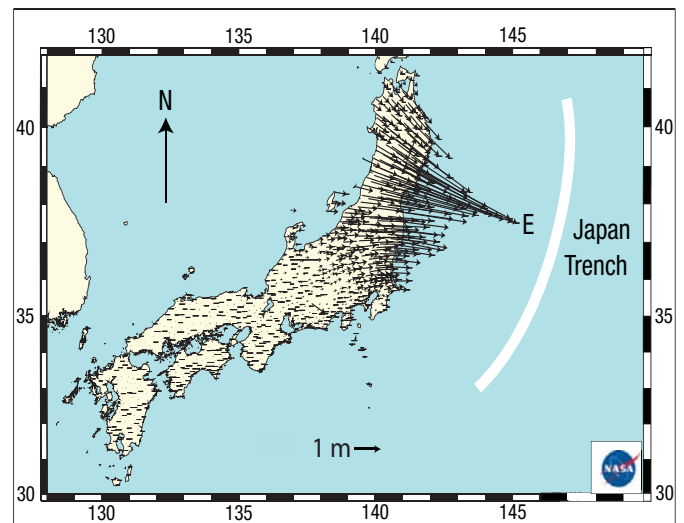

Figure 91: Strange Displacements during the 9.0 magnitude, 11 March 2011 Japanese Earthquake. The Japanese government, using the Global Positioning System (GPS), continuously measures the location of 1,200 points to an accuracy of better than an inch. Each arrow above shows the direction and distance that a point on the ground moved during that earthquake. Some points moved 18 feet (5.5 meters)!⁴⁶ Horizontal movements converged toward the epicenter, Point E. The actual earthquake began at the focus, 20 miles below Point E (below the Earth's surface), on the fault (the Benioff zone) that descends from the Japan Trench—down and to the west, under Japan.

How can rock suddenly converge *radially* toward a point? Obviously, rock near the focus, far below Point E, must have been removed to make room for the convergence—to allow the surrounding rock to collapse. As discussed on page 156, frictional heating along the fault first melts grain-sized minerals with the lowest melting temperatures, causing them to expand, because they were above the crossover depth. (Remember: Tiny movements at the extreme pressures deep in the Earth produce great heat and melting.) Minerals with higher melting temperatures remain solid, maybe for centuries, thereby encasing and trapping the tiny droplets of melted rock. [See **“Liquid Droplets Seen in Hot, Compressed Rock”** on page 164.]

If frictional heat steadily “soaks” into the rock on both sides of a fault, magma droplets will increasingly form, so sooner or later, leakage will begin. Paths will open for the expanding melt to escape upward buoyantly. The highly compressed solid “scaffolding” (composed of minerals with the highest melting temperatures) will become unstable and eventually collapse. Frictional heating will instantly become extreme, so all nearby minerals will suddenly melt. The result: a powerful earthquake.

Similar events occur *below* the crossover depth, except there the melted minerals “shrink” (become denser), and slowly drain along faults down into the outer core. This ongoing process releases gigantic amounts of heat throughout the mantle and core,⁴⁷ and will eventually produce many powerful earthquakes. However, when that will happen is uncertain.⁴⁸

ocean trenches, tablemounts, and the dropping of the Pacific Basin as one huge block. Most of those geologists believed that a molten Earth shrunk as it cooled over millions of years. However, because they could not provide convincing details, their idea has fallen into disfavor. [The belief in a molten Earth can be easily rejected. See **“Molten**

Earth” on page 28.] Nevertheless, the idea of millions of years has remained in most people’s imaginations.



PREDICTION 8: The mean radius of the Earth has shrunk about 180 miles since before the flood. Earth is still shrinking, but at a much slower rate.

While these geologists did see evidence of shrinkage, they were reasoning only from the effects they saw back to possible causes. Had they also arrived at a consistent picture by reasoning from cause to effect and not been satisfied until the forces, energy, and mechanisms were understood, they would have been on firmer ground.

What caused the shrinkage? The greatest movements (within the Earth) caused by the rising Atlantic floor would have been at the center of the Earth. [See “**Forming the Core**” on page 160.] Also, the center of the Earth, where pressures are greatest, would have produced the greatest melting and shrinkage. Even slight movements of one mineral grain relative to an adjacent grain at those extreme pressures will produce instant melting followed by about 50% shrinkage. [See “**Magma Production and Movement**” on page 156.]

As the Atlantic side of the inner Earth rose, the Pacific side of the inner Earth had to collapse onto the magma forming and shrinking near the center of the Earth. This runaway subsidence, melting, and shrinkage fractured and distorted much of the Pacific side of the Earth—especially the brittle Pacific crust. Because the Pacific crust would not have dropped as “one huge block” (as early geologists thought), its thousands of fragments, buried under and within the magma that rose to the surface, will be difficult to detect seismically. **However, the largest block, greater in area than India, is now recognized as a 94% submerged continent called, Zealandia.**⁴⁹ Researchers are also detecting some granite under the floors of the Pacific and Indian Oceans.⁵⁰

Indeed, the presence of andesite, a fine-grained mixture of granite and basalt, west of the andesite line shows that at least fragments of continental rock (primarily granite) lie below the floor of the entire western Pacific. [See Figure 93.]

*The types of rock found on [western Pacific] islands help to determine the edge of the Pacific Basin. The **andesite line** has on its ocean [eastern] side rocks composed primarily of basalt, whereas on the other [western] side they are principally andesite. This has been viewed as the dividing line between oceanic and continental crusts.”⁵¹*

For the most part, the andesite line also marks the true limit of the continents.”⁵²

Trenches formed and plates moved by the power of gravity. Gravity always tries to make the Earth more compact (or spherical).⁵³ If you suddenly removed a bucket of water

from a swimming pool (or even a 60-mile-thick layer of rock lying above what is now the Atlantic floor), gravity would tend to smooth out the irregularity. Because massive volumes of rock inside the Earth do not flow as fast as water in a swimming pool, mass deficiencies, which we might think of as slight partial vacuums, still exist under trenches. Today, especially at low tide (when the water’s pressure on the ocean floor is a minimum), mantle material slowly seeps in under trenches to reduce these “partial vacuums.” This stretches the crust above, produces extensional earthquakes near trenches, shifts plates toward trenches, and makes the Earth measurably rounder.⁵⁴

Both the hydroplate theory and the plate tectonic theory are explained as their advocates would explain the theories. One should critically question every detail of both theories, and not accept either until all available evidence has been considered.

The Plate Tectonic Theory. Earth’s crust is broken into rigid plates, 30–60-miles thick, some with an area roughly the size of a continent. Some plates carry portions of oceans and continents. Plates move relative to each other over the Earth’s surface, an inch or so per year.

Trenches formed and plates move by heat from radioactive decay. Just as hot water circulates in a pan on a stove, hot rock circulates slowly inside Earth’s mantle. Radioactive decay warms some parts of the mantle more than others. The warmer rock expands, becomes less dense (more buoyant), and slowly rises, as a cork rises when submerged in water. Sometimes, plumes of hot rock rising from the outer core break through the Earth’s crust as flood basalts. Conversely, relatively cold rock descends. Rising and descending rock inside the mantle forms circulation cells (convection cells) which drag plates forward. Currents within the mantle rise at oceanic ridges, create new crust, and produce seafloor spreading.

Because new crust forms at oceanic ridges, old crust must be consumed somewhere. This happens wherever two plates converge. The older plate is denser, because it had more time to cool. Therefore, it sinks below the younger plate and subducts into the mantle, forming a trench. A cold, sinking edge will pull down the rest of the plate and enhance circulation in the mantle. Earthquakes occur under trenches when subducting plates slip along Benioff zones and when plates slip past each other. At great depths, subducting plates melt, releasing magma, which migrates up to the Earth’s surface to form volcanoes. Most of the Ring of Fire is produced by subducting plates. Such slow processes require hundreds of millions of years to produce what we see today.

Evaluation of Evidence vs. Theories

The preceding discussions raise many issues concerning trenches, earthquakes, and the Ring of Fire. Each issue, summarized below in italics and given a blue title, is

What Causes Earthquakes, and Can They Be Predicted?

Earthquakes are the deadliest of today's natural disasters. Each day, on average, earthquakes *kill 78–500 people and destroy about \$500 million in property.*^{55,56} Current scientific understandings do not fully explain earthquakes, so a better paradigm is needed.

Everyone agrees that an earthquake is a sudden slippage along a long, preexisting fracture—a *fault*—inside the Earth. Much greater forces and energy are required to produce those fractures than the slippage, so any explanation for earthquakes must first explain the fractures.

What produced the preexisting fractures? The plate tectonic theory doesn't tell us how those fractures occurred, but only tries to explain earthquakes that occur at plate boundaries when plates rub against each other. How plates and their boundaries formed is never explained, but, as Figure 90 on page 161 shows, most earthquakes occur not at plate boundaries, but on faults inside or below plates.

During the flood, gigantic shifts of mass produced thousands of fractures through Earth's crust *and mantle*. These shifts included: the deposition of a mile-thick layer of sediments on the continents, the uplift of the Atlantic floor and the corresponding subsidence on the Pacific side of the Earth, rapid continental drift, the compression event that pushed up major mountain ranges in less than an hour, and as explained on page 156, melting at Earth's center that produced a 50% shrinkage of the inner Earth that is now Earth's core.

What causes slippage on a fault? Most earthquakes occur when forces parallel to and on opposite sides of a lubricated fault differ enough. Migrating liquid within the Earth lubricates faults, initiating slippage. The liquid can be some of the remaining preflood subterranean water or magma produced by frictional heat that melted rock.

Powerful vertical shifts within the Earth (all driven by gravity) produced thousands of shearing fractures throughout the mantle. Thus, thousands of blocks, each as tall as the mantle is thick, are bounded by these fractures. (Crushed and buckled continental crust rests on these blocks.) Each mantle block is normally locked by friction to adjacent blocks. Below the cross-over depth, very dense magma, produced by sliding friction and the extreme pressure deep inside the Earth, slowly drains down the thin cracks (faults) that separate the blocks and into the liquid outer core, releasing heat. [See **"Forming the Core"** on page 160.] Therefore, the outer core is steadily, ever-so-slightly, expanding and increasing the upward pressure on the bases of these blocks. Periodically, the block least locked by friction to its adjacent blocks will slip upward.⁵⁷ The raised crust directly above is then on a slight downward slope, which, if great enough, will slip horizontally and produce an earthquake.⁵⁸ That vertical slippage between mantle blocks melts more mantle rock and produces more draining magma—and heat. These cycles will continue. Because of the

steady increase in heat, **earthquakes will someday increase in frequency and severity.**⁵⁹

Frictional heat generated by slippage along a fault increasingly melts, deep within the walls of the fault, mineral grains with the lowest melting temperatures. Above the crossover depth, the liquid droplets expand and stretch the surrounding rock; below the crossover depth, the droplets shrink, so the surrounding rock is collapses and is compressed. As frictional heating increases, more magma droplets form, merge, and eventually escape along faults.⁶⁰ The surrounding rock may then collapse as an earthquake. Magma draining from between mantle blocks and into the core opens up space, so the continents slowly shift, as shown in Figure 94 on page 171. Notice that this movement is not caused by the rock-solid mantle (84% of Earth's volume) magically circulating, as incorrectly taught to generations of students. It is caused by magma draining along faults within the mantle—faults produced during the global flood.

Stresses produced by these movements generate voltages by piezoelectric⁶¹ and other effects.⁵⁶ The voltages build up over days and weeks for many miles around what will become an earthquake's point of origin (the focus).⁶² For centuries, electrical effects have been recognized as preceding earthquakes.⁶³ Satellites can now detect these in the ionosphere, about 40–600 miles above the Earth.⁶⁴

How can the specific locations of major earthquakes be predicted days beforehand? Since 2018, British and Russian scientists have operated TwinSat, a multi-satellite and ground detection system to identify and precisely locate electrical signals that precede earthquakes and volcanic eruptions.⁶⁵ China is developing a similar system.⁵⁶ Such signals were accidentally detected by a French satellite days before both the 2011 Japanese earthquake and tsunami that killed about 20,000 people and the 2010 Haitian earthquake that killed over 300,000. Each quake produced more than a hundred billion dollars in damage. Tragically, both sets of unexpected electrical signals were ignored, because their connection with earthquakes was unknown.⁶⁶ As the designers of this multimillion dollar TwinSat project acknowledged,

*The links between the seismo-tectonic process and atmosphere/ionosphere earthquake precursors remain poorly understood.*⁶⁷

Researchers now know the types of electrical signals that build up in the ionosphere *directly above a future epicenter*, and that heat emissions often occur nearby, but admit they don't know why they occur.⁶⁸ (The heat emissions are from magma escaping upward along faults.)

When you finish Part II of this book, you should have an understanding these researchers currently lack. Their main difficulty is not the physics of the process or an acceptance of all the supporting evidence. Their difficulty will probably be an unwillingness to consider a global flood and a new scientific paradigm.

Liquid Droplets Seen in Hot, Compressed Rock

Professor Wendy Mao, a mineral physicist at Stanford University, has duplicated the pressure-temperature conditions 125 miles (200 kilometers) below the Earth's surface. She compressed a tiny piece of silicate rock that was mixed with an iron-rich alloy. Then, she heated the sample to 3,300°F (1,800°C) and, with a series of x-rays, produced a three-dimensional image. The iron melted and became tiny spherical droplets encased in a solid silicate matrix.⁶⁹ They looked like bubbles in a block of ice.

What can we conclude? If no more heat is applied, the mixture will be stable. The trapped liquid will support the solid “scaffolding,” just as trapped liquid in a waterbed can support a person lying on top—and, before the flood, trapped, high-pressure liquid in the subterranean water chamber helped support Earth's crust.

Today, very slight amounts of slippage frequently occur along thousands of faults in the crust and mantle, especially where faults extend from a trench down through the entire mantle to the growing liquid foundation of the outer core. If, instead of a solid foundation, your home rested on a dense liquid foundation, you can imagine how cracked the walls of your house would be if ripples sometimes pulsed through the liquid or if that foundation slowly rose by the steady addition of dense liquid. Slippage would frequently occur along the weakest cracks in the walls. Within the

mantle, slippage along faults produces more magma, most of which drains down those faults and into the outer core, adding to its volume and causing more uplift, slippage, and ripples. The mantle is unstable, but not circulating.

Frictional heat generated along faults throughout the mantle conducts slowly into the walls of the fault. Above depths of 410 miles (700 kilometers), local instabilities sometimes arise as heat weakens the solid silicate scaffolding and forms more droplets. Once leaks form, the liquid droplets can escape; their buoyancy forces them upward if they are above the crossover depth or downward if they are below the crossover depth. The gravity field changes. Shortly thereafter the scaffolding collapses and produces an earthquake. These gravity changes have been measured.⁷⁰

The mantle is essentially solid, so even below 410-mile depths the same slippage produces friction and heat. Why then do earthquakes not occur below 410 miles? At those great depths, when heating along faults melts minerals with low melting temperatures, the droplets shrink even more, so their individual encasements collapse more and experience further frictional heating. That, plus the higher temperatures at those depths, weakens and collapses the scaffolding *before leakage can occur*. Because these deformations are plastic, no earthquakes occur below 410-mile depths.

PREDICTION 9: By 2020, satellites in low-Earth orbits will predict the locations of major earthquakes several days before the quakes. The satellites will measure electrical changes in the ionosphere that are produced by piezoelectric voltages building up in stressed rock around the focus of the coming earthquake. If the focus is above the crossover depth (220 miles below Earth's surface), upward escaping magma may also produce detectable heat around the epicenter days before the quake. [See “**What Causes Earthquakes, and Can They Be Predicted?**” on page 163.]



examined from the perspective of the hydroplate theory (HP) and the plate tectonic theory (PT). My subjective judgments, coded in green, yellow, and red circles (reminiscent of a traffic light's go, caution, and stop) provide a starting point for your own evaluations. Numbers in Table 3 refer to explanations that follow. Any satisfactory explanation for the origin of trenches, earthquakes, and the Ring of Fire should resolve or credibly address the italicized issues below.

Table 3 will help us compare the evidence with two completely different explanations for ocean trenches. Too often, alternative theories are never known or sought, or a theory is justified based on only *some* of the relevant evidence, while all other evidence is ignored. When this

happens, doctrine reigns and critical thinking ceases. Please alter Table 3 by adding or removing evidence or theories (rows or columns) as you weigh the choices.

Evidence Requiring an Explanation

The Ring of Fire. *What accounts for this most volcanically violent and seismically active region on Earth, and why does it surround all but the southern side of the Pacific Basin?*

- 1. **HP:** The Ring of Fire, shown in Figure 83 on page 152, marks the path of greatest shearing that resulted from melting and contraction under the Pacific plate prior to the continental-drift phase. Months earlier, the rupture fractured the Pacific plate's *southern* boundary, so it did not experience violent shearing.
- ⊗ 2. **PT:** Subducting plates mark most of the Ring of Fire. The southern Pacific is complex.

[Response: Table 4 on page 176 gives 17 reasons plates have not subducted.]

Gravity Anomalies. *Why do Earth's greatest mass deficiencies exist under trenches, even after adjusting for their shapes?*

Table 3. Evidence vs. Theories: Origin of Ocean Trenches, Earthquakes, and the Ring of Fire

	Theories			
	Hydroplate Theory		Plate Tectonic Theory	
	Driven by Gravity		Driven by Heat	
The Ring of Fire	●	1	⊗	2
Gravity Anomalies	●	3	⊗	4
Core-Mantle Boundary	●	5	⊗	6
Flood Basalts	●	7	⊗	8
How Are Plates Made?	●	9	⊗	10
Water in the Upper Mantle	●	11	⊗	12
Seamounts and Tablemounts	●	13	⊗	14
Stretched Oceanic Ridges	●	15	⊗	16
Scattered Volcanoes	●	17	⊗	18
Continental Material under Ocean Floor	●	19	⊗	20
Images of Earth's Interior	●	21	●	22
Fast Seismic Waves	●	23	⊗	24
Fossils in Trenches	●	25	⊗	26
Deep Earthquakes	●	27	⊗	28
Earthquakes Far from Plate Boundaries	●	29	⊗	30
Earthquakes Correlate with Low Tides	●	31	●	32
Earthquake Driving Force	●	33	⊗	34
Plate Reversals	●	35	⊗	36
Earthquakes Drop Local Gravity	●	37	⊗	38
Tension Failures	●	39	⊗	40
Wide Earthquakes	●	41	⊗	42
Reasonable Driving Mechanism	●	43	⊗	44
Displaced Material	●	45	⊗	46
Frictional Resistance	●	47	⊗	48
Arcs and Cusps	●	49	⊗	50
Concentrated Trenches	●	51	⊗	52
Undistorted Layers in Trenches	●	53	⊗	54
Initiation	●	55	⊗	56
"Fossil" (Ancient) Trenches	●	57	⊗	58
Other	●	59–61	⊗	62–65

Evidence to be Explained

The Origin of Ocean Trenches, Earthquakes, and the Ring of Fire

Key: ● Explained by theory.
 ● Theory has moderate problems with this item.
 ⊗ Theory has serious problems with this item.

Numbers in this table refer to amplifying explanations on pages 166–178.

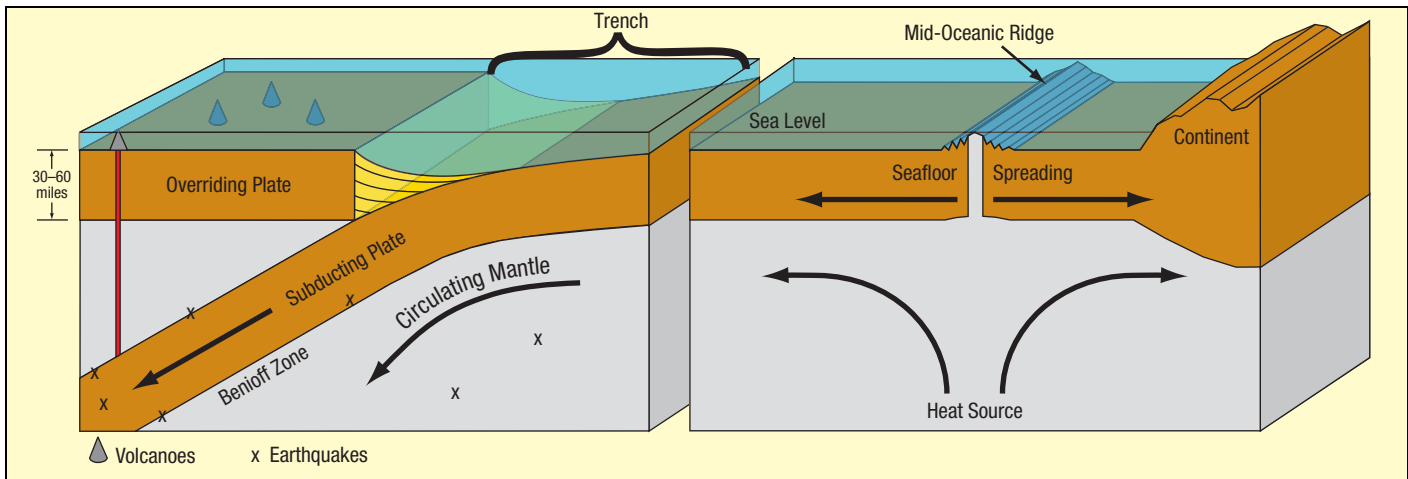

Figure 92: Plate Tectonic Explanation for Trenches. Internal heat circulates the mantle, causing large plates to drift over the Earth's surface. Consequently, material rises at oceanic ridges, forcing the seafloor to spread, so plates must subduct at ocean trenches, allowing layered sediments, shown in yellow, to collect. Earthquakes usually occur where plates subduct (Benioff zones) and at other plate boundaries. Subducting plates also melt rock, and the resulting magma rises to form volcanoes.

[Response: Actually, most volcanoes are not above Benioff zones. If this theory were correct, the sediments (shown above in yellow) would hide a cliff face that is at least 30 miles high and the trench axis should be a straight line. Also, some very large earthquakes occur far from plate boundaries. The powerful New Madrid, Missouri earthquakes of 1811 and 1812 and Charleston, South Carolina earthquake of 1886 are famous examples.]

- 3. **HP:** As the Atlantic floor rose, all the material below it had to rise as well, so trenches in the western Pacific were pulled down (toward the rising Atlantic). This created the mass deficiency below trenches.
- ⊗ 4. **PT:** Plates are subducting into the mantle, so mass is continually added and compacted under trenches. While this increases (not decreases) the pull of gravity under trenches, other factors may play a role.

Core-Mantle Boundary. Why is there a sharp density discontinuity at the core-mantle boundary? Below that boundary, magma's density is almost twice that of the rock immediately above. [See the cells highlighted in red on page 604.]

- 5. **HP:** Magma is much more compressive than rock, so it should have a much higher density at those depths and pressures. Magma was produced primarily by gravity and an extrusion process near the center of the Earth. See "**Forming the Core**" on page 160 and "**Magma Production and Movement**" on page 156.
- ⊗ 6. **PT:** The Earth evolved by meteoritic bombardment over hundreds of millions of years. The heat released by all Earth's material falling in from outer space made Earth completely molten. Over billions of years, most of Earth cooled and solidified. Only the outer core is still molten.

[Response: This false idea is exposed at "**Molten Earth?**" on page 28.] The Earth was never molten.

Flood Basalts. Vast amounts of melted basalt rapidly erupted onto the (solid) Earth's surface, especially in and surrounding the western Pacific. How did this happen, and why was it so rapid?

- 7. **HP:** Magma outpourings resulted from the following chain of events:
 - ◆ the bulging of the chamber floor in what was to become the Mid-Atlantic Ridge, this bulging produced movements deep within the Earth that resulted in deep faulting (shearing), frictional heat, and melting,
 - ◆ the contraction of magma below the crossover depth, and the eruption of magma above the crossover depth,
 - ◆ the resulting subsidence of the Pacific plate, and
 - ◆ the accelerating of hydroplates away from the rapidly rising Atlantic floor and toward the subsiding Pacific. (A similar acceleration occurs when a horizontal teeter-totter board, with a massive rock resting at its center, slowly begins to tip. The tipping rate will increase at an accelerating rate, so the rock will rapidly slide—accelerate—down the board and crash.)

This explanation answers all the questions in the "**Volcanoes and Lava**" and "**Geothermal Heat**" discussions, beginning on page 118. Because these deep faults often intersect the Earth's surface as linear features, we have many linear island chains, but with different orientations.

Magma rises to the Earth's surface along deep faults, not in plumes. Rising as plumes presents "severe thermal and mechanical problems." Magma can rise along faults a million times faster.⁷¹

- ⊗ 8. **PT:** Over millions of years, plumes of magma can rise from the liquid outer core.

[Response: As explained on page 156, below the crossover depth of 220 miles, magma is too dense to rise. This also means that mantle circulation is a fiction.

This mistaken idea arises because seismic tomography has found more than two dozen examples of magma paths joining the outer core to the Earth's surface.⁷² However, as we have shown, magma (produced by friction along faults that extend from the Earth's surface to the outer core) drains down below the crossover depth and rises above the crossover depth. Therefore, a magma path does join the core with the Earth's surface, but magma never rose from the core as a plume.

Even if a hot plume of magma could slowly rise through the entire mantle, the plume would lose heat to colder, overlying rock. This heat loss would exceed the excess heat in the plume. Calculations show that hot plumes cannot rise from the outer core and produce flood basalts.⁷³ Nor will current processes open cracks in the mantle so a plume can rise. Confining pressures under the crust are simply too great.

An old, now discredited,⁷⁴ idea used in popularizing plate tectonics was that fixed "hotspots" exist inside the Earth. Supposedly, plumes of hot, melted rock continually rise from the Earth's core upward through the mantle. Over millions of years, as a plate somehow slid over a hotspot, the plate melted along a line and produced volcanoes and flood basalts. Yellowstone National park is frequently given as one example.

The Hawaiian Islands were considered the best example of this.⁷⁵ Not explained were the long chains of submarine volcanoes that intersected the Hawaiian chain—some at large angles. It is now recognized that if hotspots exist, they must move.⁷⁶ Other volcanic chains, such as the Bermuda Rise, are almost perpendicular to the claimed movements of their plates.⁷⁷

If the mantle circulates enough to move a plate, why is a hotspot's plume in that moving mantle fixed? If a chain of volcanoes means its plate is drifting, does an isolated volcano mean that its plate is not drifting? Faster moving plates should have fewer volcanic cones "burned" through them than slower plates. Just the opposite is the case.⁷⁸ Also, the chemistry of rocks comprising these "hotspot" chains indicates that the magma originated from the upper mantle, not the lower mantle boundary as claimed by plate tectonics.⁷⁹ Endnote 73 explains the most compelling objection to the hotspot idea—the absence of a physical mechanism.]

How Are Plates Made? *To form plates, the crust must break along many long paths. How could this possibly happen?*

- 9. **HP:** Centuries before the flood, supercritical water in the subterranean chamber began dissolving the more soluble minerals in the lower crust, such as quartz. This weakened the lower crust as it became increasingly porous (spongelike). As pressure from tidal pumping continued to build up in the chamber, the crust

stretched and eventually broke, just as a balloon will break as pressure inside increases. The tension crack began as a microscopic crack and then propagated through the brittle crust and around the Earth at about 3 miles per second. The crack followed a great-circle path, the path of least resistance. After about 2 hours, one end of the crack ran into the path left by the other end of the crack. Once the tension in the crust was released, the other end of the crack stopped.

The crust, resting on trapped water, could slip horizontally without resistance as it was stretched. Had the base of the massive crust been pressed against the mantle rock below, frictional locking would have prevented slippage, so the crust could not have ruptured—and certainly not in a globe encircling path. Plates would not exist.

Pressure on the chamber floor directly below the rupture dropped, so that portion of the chamber floor bulged upward, as shown in Figure 65 on page 131. This is how the Mid-Oceanic Ridge, which generally has a great-circle path, formed.

- ⊗ 10. **PT:** Three hypotheses have been proposed,⁸⁰ although each has problems:
 - a. *One edge of a plate started to subduct, and that ruptured the crust.* Unfortunately, that presupposes that the crust already had an edge, which would have required a prior rupture. How did that edge form? Why did the edge start to subduct? Even if it did, all the Earth's tectonic plates would not have formed.
 - b. *Volcanic plumes rose from the outer core to the Earth's surface, weakened the crust, and caused it to fail.* We have already seen (in "Flood Basalts" on page 166) the many problems with the claim that plumes of magma rise from the core to the Earth's surface, through 2,800 miles of solid mantle rock. Even if that could happen, it would not produce all plate boundaries.
 - c. *The crust radiated its heat into outer space, making it cooler and, therefore, denser. After millions of years large regions on the ocean floor began to sink, rupturing the crust.* Laboratory experiments that supposedly demonstrated this were completely unrealistic. A cooling layer of liquid, resting on a warmer layer of liquid, did subduct. However, liquids would not provide the frictional locking that rock pressing down on rock would. Besides, a colder rock layer on top would be stronger and might not stretch enough to rupture, and the greater temperature contrast (and propensity to subduct) would have been on the continents, not the ocean floor.⁸¹

Water in the Upper Mantle. *What concentrated so much pooled water 500–750 miles below eastern Asia and parts of western North America?²⁸*

- 1. **HP:** Rapid melting of the inner Earth released large amounts of water locked at the molecular level within minerals. That water rose because of its low density. Most spilled into the Pacific Basin along with flood basalts, but some water was, and still is, trapped and pooled under continental regions bordering the Pacific Ocean.
- 2. **PT:** Subducting plates carried ocean water down into the mantle where it was released under eastern Asia and western North America.

[Response: Table 4 on page 176 gives 17 reasons plates have not subducted.]

Seamounts and Tablemounts. *Why are 40,000 seamounts (undersea volcanoes) on the floor of the Pacific Ocean? Tablemounts show that either sea level rose by 3,000–6,000 feet or the ocean floor dropped by 3,000–6,000 feet—or some combination of both. How could this have happened?*

- 3. **HP:** See “The Origin of Tablemounts” on page 169.
- 4. **PT:** When a plume of molten material erupts onto the ocean floor, especially at ridges, it sometimes forms a volcanic cone, called a seamount. Over millions of years, the plate supporting that cone drifts toward a subduction zone, cools, and subsides. As the seamount goes below sea level, its top is flattened by wave action.

[Response: Those favoring this explanation admit that tablemount heights are inconsistent with this explanation.⁸² However, tablemount heights are consistent with the hydroplate theory, which explains why ocean depths were lower than normal for a few centuries after the flood. Item 8 above explains why plumes cannot rise through the entire mantle, and certainly not from more than 220 miles below Earth’s surface.]

Stretched Oceanic Ridges. *The topography along oceanic ridges is best explained by stretching the ocean floors in two perpendicular directions. How could that happen?*

- 15. **HP:** As the Atlantic floor and Mid-Oceanic Ridge rose, they stretched in all directions, for the same reason an expanding balloon stretches in all directions.
- 16. **PT:** Plate tectonics describes this stretching as seafloor spreading—movement of the ocean floor away from the ridge.

[Response: Even if seafloor spreading occurs, it would only account for one stretching direction (perpendicular to the ridge), not two. See Figure 92 on page 166.]

Plate tectonics proposes three possible means for moving plates: push, pull, or drag. Each has problems.

Push. If material rising from below the ridge is somehow pushing ocean crust away from the ridge, ocean crust would be compressed, not stretched.

Pull. If crust is being pulled away from the ridge, what is the pulling force? Some believe that the edges of plates are pulled down under trenches. However, rocks are weak in tension, so they can pull very little without breaking. Even if this were not a problem, many evenly spaced cracks (flank rifts) lie parallel to the ridge axis. Once the first crack began, a strong pulling force would pull the plate apart at only one place. *Multiple* parallel cracks, as seen at flank rifts, would not form.

Drag.⁸³ If the mantle is circulating below the ocean floor and dragging the underside of the ocean crust away from the ridge, that drag would not stretch the ocean crust. For example, drag acts on a block of wood drifting in a stream, but no stretching force acts.

So plate tectonics can point to no force that will stretch oceanic ridges in even one direction, let alone two.]

Scattered Volcanoes. *On the western Pacific floor are 40,000 volcanoes taller than 1 kilometer. Why do most lie inside, instead of outside, the trench region?*

- 17. **HP:** As the Atlantic floor rose the Pacific and Indian Oceans subsided, and the entire western Pacific was fragmented and distorted. Frictional melting produced large volumes of magma, some of which erupted onto the Pacific plate and produced volcanoes.
- 18. **PT:** Most volcanoes on the western Pacific floor lie on the wrong side of trenches, according to the plate tectonic theory.

Continental Material under Ocean Floor. *Some granitic, or continental, rock is found under the floors of the western Pacific and southern Indian Oceans.*⁵⁰

- 19. **HP:** Basalt, not granite, lies below sediments that continually fall onto the floors of the Pacific and Indian Oceans. The basalt, recovered by deep-sea drilling, is not oceanic crust, but once flowed as a liquid up onto the ocean floor.⁸⁴ What remains of the 50-mile-thick granite crust after it broke up (and partially melted) must lie a few miles under the lava coating the western Pacific floor. This has not yet been verified, because drilling into the Pacific and Indian Ocean floors seldom exceeds a mile in depth.⁸⁵ Current drilling, typically only 0.11165 mile deep, penetrates primarily ooze and other sediments that have settled onto the ocean floor in the last several thousand years. Nevertheless, some continental material has been discovered, to the surprise of most geologists.⁵⁰

Geologists refer to a line running down the west-central Pacific as the “**andesite line**.” It has this name because eruptive rocks west of it are primarily andesite, whereas rocks to the east are primarily basalt. Andesite contains minerals, such as hornblende and biotite, that

The Origin of Tablemounts

Tablemounts, also called *guyots* (GHEE-ohs), are flat-topped volcanic cones that lie 3,000–6,000 feet below sea level and rise 9,000–15,000 feet above the ocean floor. Experts agree that their tops were flattened (truncated) by wave action. This also explains why shallow-water corals and fossils and rounded cobbles and pebbles often cover tablemounts. Therefore, sea level was once 3,000–6,000 feet lower relative to the flat tops of tablemounts.

Most of the 2,000 known tablemounts are concentrated in the western Pacific, between Hawaii and Japan and between 8° and 27° north latitude. This is the center of the ocean-trench region, directly opposite the center of the Atlantic Ocean, on the other side of the Earth. The following scenario seems to explain when and how tablemounts, with their strange elevations, formed.

As the continental drift-phase began, the Atlantic floor steadily rose. Rock, extruded by powerful gravity forces through the center of the Earth, deformed, melted, and shrank. [See “Forming the Core” on page 160.] Within hours that shrinkage produced more melting and breakup, especially on the Pacific plate and below. Before even 3% of the magma that is now in the outer core was produced, the Pacific plate had broken up and subsided more than 60 miles,¹³ forming the Ring of Fire. The resulting friction melted much of that granite plate.

Granite’s high silicon content produces a highly viscous magma when granite melts. High viscosity⁸⁶ is what makes volcanic cones steep.⁸⁷ (Most magma has relatively low viscosity and does not produce cones.) Volcanic cones growing under water will be taller and steeper, because the magma rapidly solidifies, so there is little downhill flow. Being under water also gives that rock a buoyancy, which helps submarine volcanoes grow taller. To demonstrate this effect, support a large rock under water with one hand. Notice how the pressure on your hand increases as you slowly lift the rock out of the water.

The first magma to spill out on top of the sinking Pacific plate was rich in silicon from the plate’s granite. The cones produced grew up to the surface of the new Pacific Ocean. There, waves flattened the tops of the cones, forming tablemounts. Since then, the magma spilling out on the Pacific floor has been primarily flood basalts, which contain little silicon, so volcanic cones did not form. Instead, those flood basalts paved the top of the Pacific floor and raised sea level worldwide 3,000–6,000 feet above the tops of the tablemounts.

Other observations support this scenario:

- a. Submarine canyons show that sea level was once 15,000 feet below today’s sea level. This rise in sea level can be attributed to: (1) deeper portions of the

ocean floor holding considerable ocean water soon after the flood when submarine canyons were carved, (2) continents and continental slopes sinking into the mantle since the flood, and (3) ground water draining into the oceans since the flood.

- b. Eniwetok Atoll, composed of corals almost a mile deep,²⁴ lies in the tablemount region and rests on a tablemount.⁸⁸ To grow, most corals must be within 160 feet of the ocean surface.⁸⁹ Under ideal conditions today, corals can grow 1.3 feet per year.⁹⁰ Therefore, at Eniwetok, the last mile in the rise of sea level was slow enough for corals to grow continually, up to the present time.
- c. Tablemounts are not drowned coral atolls, as once proposed and finally rejected by Harry Hess, who discovered tablemounts.⁹¹ The tops of tablemounts and atolls differ in shape. Had tablemounts been slowly submerged below sea level, most would have coral growths rising to near sea level, and their tops would have similar shapes.
- d. Clustered tablemounts sometimes differ in elevation and depth by 1,000–2,000 feet,⁹² so they apparently formed at different times while local ocean depths were changing rapidly. This probably happened years after the compression event, as the lower mantle below the Pacific plate sank into the growing liquid outer core. When new cracks permitted magma to escape upward, seamounts grew from different depths. Therefore, the first tablemounts that formed were usually shorter than tablemounts formed after the plate had been pulled deeper. Earlier tablemounts were pulled down farther than those that formed later. Consequently, short tablemounts can be far below sea level, while nearby, taller tablemounts can have tops at shallower depths.
- e. Sediments, including dead organisms, continually fall onto ocean floors, but tablemounts have few sediments.⁹³ Currents over tablemounts are too slow to sweep off sediments. This implies that tablemounts formed recently, certainly after the flood when most sediments were deposited.
- f. Every few years, large and sudden temperature rises, called *El Niños*, occur in the waters of the western Pacific, because magma, which began erupting near the end of the flood, still erupts—but less frequently.¹⁴
- g. Researchers on the deep-sea submersible, *Alvin*, found ripple marks, corals, and shallow-water algae 10,000 feet below today’s sea level (but on the continental slope), 400 miles east of New York City.⁹⁴ Presumably, those features formed before North America settled into the mantle.
- h. If the Mid-Oceanic Ridge in the Pacific was once above sea level, as Hopi legends suggest,⁹⁵ then sea level has risen, or the Pacific floor has subsided.



Figure 93: Andesite Line. This sharp discontinuity (shown in red) in the western Pacific was identified in 1912 by the famous New Zealand geologist, Patrick Marshall. The andesite line is considered “the most significant regional geologic distinction in the Pacific Ocean Basin,”⁹⁶ although the term **andesite line** has fallen into disuse among plate-tectonic advocates.

Volcanic islands east of the andesite line are basaltic, while islands to the west are made of andesite, a rock named for its presence in the Andes Mountains. Andesite contains minerals, such as hornblende and biotite, that are in granite (continental rock) but not in basalt. Despite its significance, geologists have never explained why continental crust lies below the western Pacific.

are present in granite, *but not in basalt*. These minerals came from melted granite. The andesite line “has been viewed as the dividing line between oceanic and continental crusts.”^{51, 52} [See Figure 93 on page 170.]



PREDICTION 10: Fragments of a 60-mile-thick granite layer (a hydroplate) will be found a few miles under the Pacific floor and inside the Ring of Fire.

- ⊗ **20. PT:** Little granite has been found.

[Response: The presence of even a little granite under the ocean floor, especially near the Mid-Oceanic Ridge, contradicts the plate tectonic theory, which says the ocean floor forms from melted basalt rising at oceanic ridges. No one has been able to demonstrate that granite can form from a melt, although students are taught that granite is an igneous material—meaning “formed from a melt.”⁹⁷ See “**Geothermal Heat**” on page 118.]

Images of Earth’s Interior. Seismic tomography should be able to show if plates do or do not subduct.

- **21. HP:** Table 4 on page 176 gives 17 reasons plates have not subducted. Each reason is a strong case against plate tectonics, which requires subduction. [See also “**Is This a Subducting Plate?**” on page 175.]

- **22. PT:** Great efforts have been made, using seismic tomography, to discover cold, subducting plates inside the mantle, specifically along Benioff zones. The results are ambiguous.

[Response: No three-dimensional subducting plate has been clearly identified. Sometimes, scientific journals will identify a two-dimensional linear feature beneath a trench, not a three-dimensional plate. However, each linear feature could be a fault, and, similar linear features are also found far from trenches.]

Fast Seismic Waves. The upper mantle is denser beneath continents than beneath oceans.⁹

- **23. HP:** After the continental-drift phase, the crushed, thickened, buckled, and sediment-laden continents slowly settled into the mantle, compressing the mantle more than normal. Consequently, seismic waves travel faster under continents.

- ⊗ **24. PT:** Mantle properties under continents do not vary by much.

[Response: Why should seismic waves travel faster under continents if the mantle has been circulating and mixing for hundreds of millions of years? Mantle properties should be uniform.]

Fossils in Trenches. Fossils of shallow-water plants are found in trenches. How did they get there?

- **25. HP:** Fossilization requires special conditions. It should be no surprise that the global flood, which fossilized trillions of animals worldwide, also formed fossils in places that later became ocean trenches. Rapid burial, necessary to form and preserve fossils, was quickly followed by the subsidence of the Pacific plate and the downward buckling that formed trenches.



PREDICTION 11: Fossils of land animals, not just shallow-water plant fossils, will be found in and near trenches.

- ⊗ **26. PT:** More research and sampling are needed.

[Response: Because plants float and quickly disintegrate, they should not be buried and preserved in one of the deepest parts of the Pacific Ocean.]

Deep Earthquakes. How can earthquakes occur 250–410 miles below the Earth’s surface where (a) pressures are so high that space cannot open up to allow movement, and (b) temperatures are so hot that rock does not break, but slowly and quietly deforms or flows?

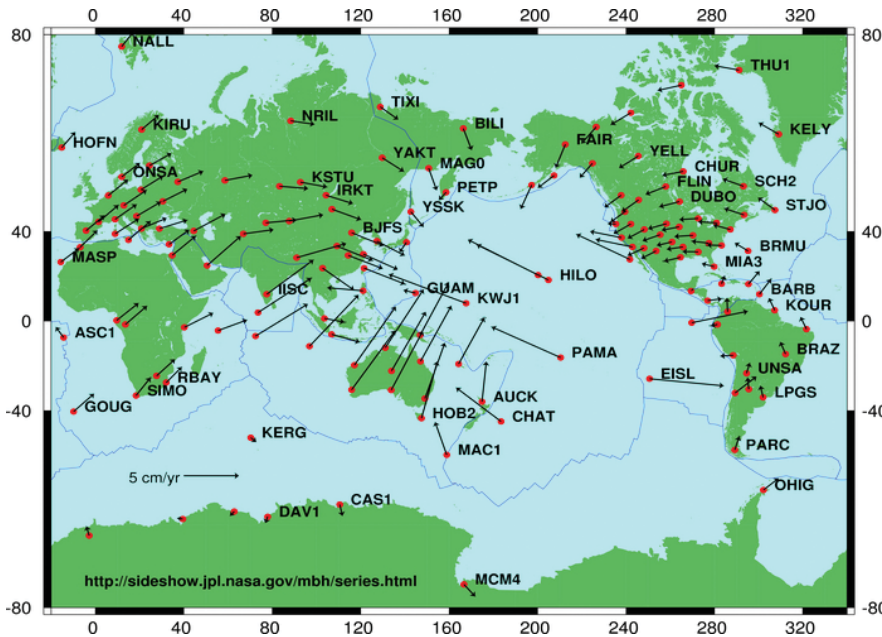

Figure 94: Global Shifts. Each arrow shows the average direction and speed of several years' worth of shifting at one of about 150 locations worldwide. All measurements were made using the Global Positioning System (GPS), the most accurate of several methods for measuring these movements.

Notice that the arrows point in different directions, although most are toward the Pacific. This shows that material deep in the Earth shifts in various directions, but generally toward the Pacific. If the entire mantle were circulating, greater uniformity would be seen in speed and direction. The plate tectonic theory considers the plates, outlined in blue, as rigid, but the variations in the measured movements show that the plates are not rigid.⁹⁹ For plates to move, pressure differences must exist. Either the pressure around the Pacific is greater than normal or the pressure under the Pacific is less than normal—or both. The hydroplate theory explains why both are true.

● **27. HP:** See Figures 90 and 91 on page 161.

⊗ **28. PT:** At certain high pressures and temperatures, the common mineral olivine undergoes a phase transformation that suddenly shrinks the mineral by 10–20%. Such implosions could produce large, deep earthquakes.

[Response: Yes, those phase transformations have been demonstrated in the laboratory, but they occur at pressures corresponding to depths in the Earth of 1,100 kilometers (680 miles).⁹⁸ Deep earthquakes do not occur below 410 miles.]

Earthquakes Far from Plate Boundaries. *Some earthquake epicenters are far from plate boundaries.*

● **29. HP:** The compression event and Earth's vertical adjustments during and after the flood produced thousands of faults throughout the mantle and crust. The weakest faults slip most frequently and are considered "plate boundaries," but occasionally other faults slip and produce earthquakes far from plate boundaries.

⊗ **30. PT:** Most earthquakes occur at plate boundaries. Although quite powerful, the New Madrid, Missouri (1811, 1812) and Charleston, South Carolina (1886) earthquakes—internal to plates—were exceptions.

Earthquakes Correlate with Low Tides. *Many small earthquakes under the Pacific floor occur at low tide.*¹⁶

● **31. HP:** Under the Pacific, this mantle flow is naturally greatest at points and times of relatively low pressure—which occur at low tides.

● **32. PT:** Earthquakes that occur under the Pacific floor are very weak.

Earthquake Driving Mechanism. *What provides the energy and forces that cause earthquakes?*

● **33. HP:** The flood produced huge mass imbalances on Earth. Gravity, acting on those imbalances, accelerated the water-lubricated hydroplates downhill. All this movement resulted in many faults that now pass through the entire mantle, as explained on pages 156–157.

The slightest movements along those faults generate frictional heat and melting. Mantle rock that melts above the crossover depth (about 220 miles below the Earth's surface) expands slightly and attempts to escape buoyantly upward to the surface of the Earth, producing volcanoes and flood basalts. Magma produced below the crossover depth increases in density, so it slowly drains downward along those faults, into the outer core. These movements produce earthquakes, especially along the major faults that formed trenches.

⊗ **34. PT:** Radioactive heating deep in the Earth sets up circulating cells within the mantle which drives crustal plates over the surface of the Earth. The leading edges of those plates are sometimes forced down into the mantle—a process called *subduction*—that forms trenches. Earthquakes occur when plates get stuck and suddenly break loose.

[Response: There is no evidence that radioactive material is in the mantle. The deepest magma and rocks ejected from volcanoes do not contain radioactive material. Furthermore, it has been known for almost a century that radioactivity is concentrated in the Earth's crust. See "Where Is Earth's Radioactivity" beginning on page 385.

Even if the mantle were circulating like a liquid, viscous drag acting on the bottom of a plate would apply only a

constant force, just as a flowing river applies a constant force on an anchored boat. So, whatever force drives earthquakes must increase with time, because nearby rock stretches weeks and months before an earthquake, much as a rubber band stretches before it snaps.

Is the mantle circulating or shifting? If it is circulating, as the plate tectonic theory claims, some unknown energy source must drive the circulation. Adding energy, such as heat, to the mantle would not make the Earth more compact, as happens during all large earthquakes.^{8,54} Besides, billions of years of movement should make the Earth about as compact as it could become.

However, shifting, driven by gravity, would make the Earth increasingly more compact and round. If the Earth's mass became unbalanced during a global flood only about 5,000 years ago, shifts might still occur. Indeed, the global positioning system (involving at least 24 Earth-orbiting satellites that can measure crustal movements with millimeter precision) shows that in Asia and perhaps elsewhere, gravity drives crustal movements generally toward the Pacific.¹⁰⁰ See Figure 94.]

Plate Reversals. *What explains slow earthquakes, and why do they sometimes reverse directions? [See Figure 95.] Why are slow earthquakes often periodic and why do they frequently precede large earthquakes.*¹⁰¹

- **35. HP:** See “The Core Below” on page 181.
- ⊗ **36. PT:** There is an obvious problem with the push, pull, or drag mechanisms; neither push, pull, nor drag can explain why slow-slip earthquakes (described on page 155) reverse direction. This “remains a mystery.”¹⁷

Earthquakes Drop Local Gravity. *The local gravity suddenly dropped after the large Sumatran earthquake in 2004.*¹²

- **37. HP:** Sliding friction along the fault before, during, and after the earthquake melted rock. The melt below the crossover depth then drained down the fault and into Earth's outer core, reducing the gravity as measured at the epicenter. Earth's rotational moment of inertia also dropped, which shortened the length of the day.
- ⊗ **38. PT:** One side of the fault suddenly lifted during the earthquake and produced a tsunami. That in itself *increased* the local gravity at the earthquake's epicenter. Therefore, there must have been a sudden drop in the density (a dilation) on the opposite side of the fault.¹²

[Response: Both the uplifting of one side of the fault (which did occur) and the proposed dilation would have increased Earth's rotational moment of inertia and increased the length of the day. However, the Sumatran earthquake suddenly shortened the length of the day by at least 3 microseconds. Melted rock that drains into the

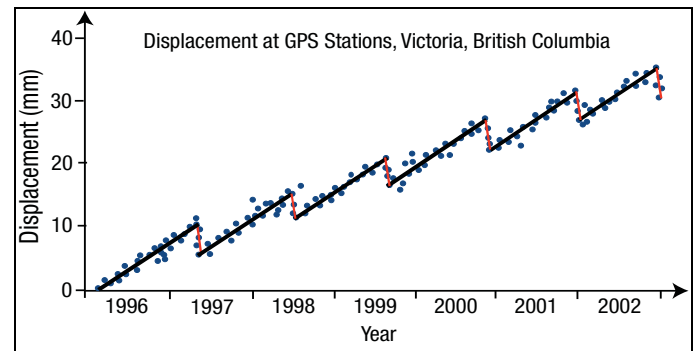

Figure 95: Plate Reversals. The Global Positioning System (GPS) is now so accurate that slow, millimeter-scale movements by crustal plates can be measured. What could cause plates to reverse direction, as shown by the red lines?¹⁷ Why, for example, would a circulating mantle suddenly start circulating in the opposite direction, or why would a subducting plate that is supposedly becoming denser and diving into the mantle suddenly defy gravity and reverse direction? Also, why are the reversal speeds so much faster than “forward” speeds (as shown by the steeper slopes on the red lines)? Similar reversals occur at other locations on Earth. (All measurements were made relative to a point on the North American Plate.)

outer core following the earthquake would shorten the length of the day and reduce gravity at the epicenter.]

Tension Failures. *Earthquakes near trenches are primarily due to horizontal tension perpendicular to the trench axis.*¹⁵

- **39. HP:** Trenches are formed by long, deep faults, not by subduction. Millions of other faults exist, especially on and under the Pacific floor. Movement and friction have melted rock along those faults, lining them with magma. Magma below the crossover depth drains into the outer core and expands the outer core slightly. This, in turn, stretches the fractured mantle horizontally. Magma rising above the crossover depth spreads the walls of the fault and produces *tension failures*—*earthquakes*—*perpendicular to a trench axis*.
- ⊗ **40. PT:** If plates converge, so that one plate is forced under the other, earthquakes near trenches should be compression failures.

Wide Earthquakes. *Some earthquakes beneath trenches rupture regions much broader than the thickness of any hypothetical subducting plate.*¹⁰²

- **41. HP:** Mantle material shifts over very broad areas, especially in the western Pacific, so some earthquakes should rupture broad regions.
- ⊗ **42. PT:** Some earthquakes may trigger nearly simultaneous earthquakes nearby.

[Response: If so, seismographs should be able to identify two earthquakes.]

Reasonable Driving Mechanism. *Forces should exist to form trenches.*



Figure 96: Pressure Differences. Only huge pressure differences cause thick, viscous material to flow. Toothpaste, squeezed from a tube, flows out the opening at a velocity that depends not on how great the pressure is, but on the *difference* between the pressure at the squeeze point and the pressure at the opening. Therefore, squeezing toothpaste inside the sunken *Titanic*, where pressures are uniformly high, or on the Moon, where pressures are low, would be no harder or easier than at your bathroom sink. Because rock is so stiff, or viscous, it flows only under extreme pressure differences, such as existed under the floor of the widening Atlantic. Tiny pressure differences, claimed by plate tectonics, can do little to overcome the strength of crystalline rock, even over billions of years.

● **43. HP:** After the flood phase, extremely large, unbalanced forces quickly lifted the lightly-loaded portion of the chamber floor that then became the Atlantic floor. Once movement began, frictional heating and gravitational settling produced magma, which immediately contracted far below the Pacific plate. Subsidence, faulting, and horizontal compression, especially in the western Pacific, formed trenches. Gravity produced all movements and forces.

⊗ **44. PT:** In a liquid, small forces can produce small movements, which conceivably could become large movements if millions of years were available.

[Response: Large, unbalanced forces are needed for crystalline rock to “flow.” Plate tectonics does not explain such forces. Assuming that the solid mantle circulates like a liquid, simplifies the mathematics but unrealistically removes the need for large unbalanced forces.

Because heat circulates water simmering in a pan, we cannot presume that heat circulates deep rock. The analogy breaks down, because temperature variations on the water’s surface change its surface tension which, is what circulates the water in the pan.¹⁰³ Rocks do not have a corresponding force. Also, rock’s viscosity⁸⁶ is 23 orders of magnitude greater than that of water! So, heat irregularities deep in the mantle are not large enough to circulate the mantle at the required velocities.

If the mantle circulates, adjacent cells must circulate in opposite directions, just as two simple interlocking gears must rotate in opposite directions. Cells circulating



Figure 97: Deforming a Sphere Inward. When the hard outer shell of a ping-pong ball is depressed on one side, it deforms in an arc-and-cusp pattern. Materials always deform in a way that minimizes the energy required.

Earth’s crust is also a hard spherical shell, so it too will deform in an arc-and-cusp pattern if the crust is pulled down. Because many trenches under the western Pacific Ocean have arc-and-cusp shapes, they probably formed by subsidence of the western Pacific floor, not by subduction.

in opposite directions under a large plate would tend to cancel each other’s ability to move the plate, so a large plate would retard plate movements. (Worse yet, subducting plates would obstruct mantle circulation.)

Could one cell circulate under each plate? A large plate, such as the Pacific plate, would need to have a much larger cell width than a plate one-thousandth as large. However, the circulating (or convection) cells we see, such as within the atmosphere or a pan of simmering water, have height-to-width ratios of nearly 1:1, not 1:10 (for large plates) or 100:1 (for small plates), as plate tectonics requires.

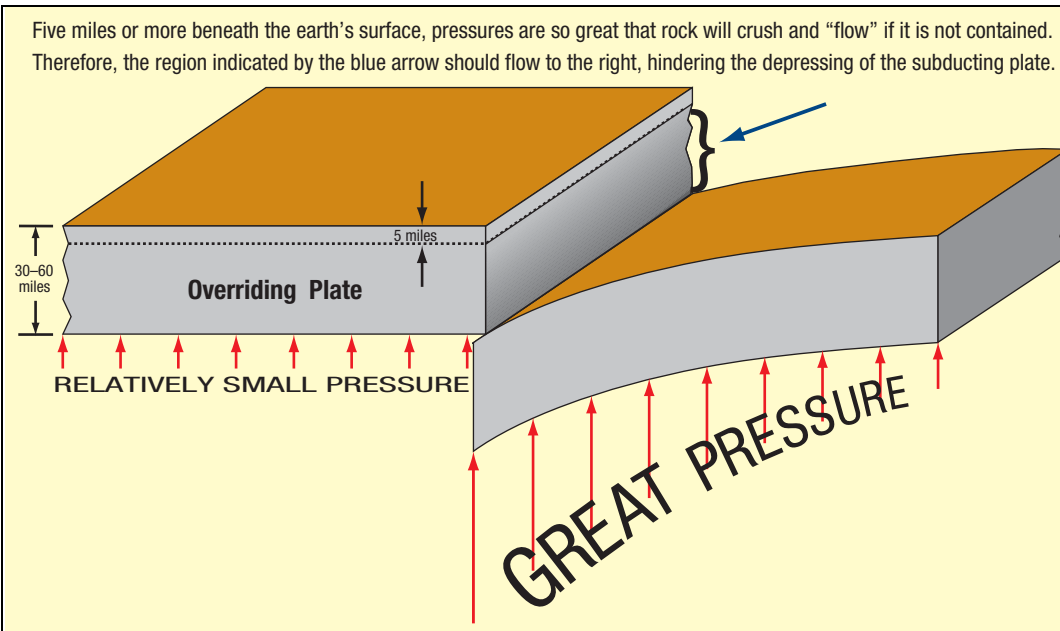

Figure 98: Subducting Plate. Pressure inside the Earth increases with depth. If one tried to depress a plate 30 miles or more below another plate, the growing upward pressure from below would quickly stop that depression long before 30 miles of depth was reached. So, subduction—necessary for plate tectonics—could not begin, even if the plate were colder and, therefore, denser, and even if rock stresses, including friction, were zero.

The technical note on page 608 explains why no continental cliff can be more than 5 miles high. Can you see from this figure why subduction violates that rule?

Tectonic plates, as hypothesized, vary in thickness. For example, a plate might be 60-miles thick under mountains but only 30-miles thick under oceans. Therefore, dragging a plate with a mountain "on board" would encounter great resistance. If we tried to slide one heavy washboard (or corrugated board) over another, their parallel ridges would interlock and resist movement. Also, if one plate stopped, the resulting "log jam" would stop all plates.]

Displaced Material. Large volumes of rock must have been removed to form trenches. Where did it go?

- **45. HP:** The rock removed to form trenches shifted toward the rising Atlantic floor. Also, rock melting below the crossover depth contracts and drains into the outer core.
- ⊗ **46. PT:** We don't know; more research is needed.

[Response: Geophysicists have often asked, "Where did that material go?" Plate tectonics has given no answer. A subducting plate, or anything pushed into the mantle, would add, not remove, material under a trench.]

Frictional Resistance. To form trenches and move so much rock, great frictional resistance must be overcome.

- **47. HP:** A block placed on an inclined plane will slide downhill if the gravity-related force exceeds the frictional resistance. Likewise, a big pit will be filled in if gravity forces can overcome the frictional resistance and strength of the walls and floor. The deeper and wider the pit, the greater the forces its walls and floor must resist. As with the sliding block, once movement begins, friction decreases, so movement speeds up. Also, the increasing momentum acts to maintain movement. If rock deep inside the Earth breaks and

slides ever so slightly, friction will melt the sliding surfaces. The magma produced then acts as a lubricant, speeding movement even more.

During the early days of the flood, upward-jetting water removed rubble from the rupture's crumbling, unsupported walls, so the pit continually widened. Eventually, the floor was so wide it buckled upward, so the hydroplates slid downhill and widened the big pit even more. With less and less weight on the widening floor, it had to rise, and a corresponding depression had to occur over a broader region on the opposite side of the Earth. Today, gravity continually tries to squeeze the Earth back toward a spherical shape.

- ⊗ **48. PT:** While the crust is hard and brittle, just below it (about 60 miles below Earth's surface) lies the asthenosphere, a region that is soft and deformable.

[Response: Even if the asthenosphere contributed no friction to a subducting plate, the 60 miles of rock above would—enough to prevent subduction. Subduction couldn't begin. See the technical note on page 592.]

Arcs and Cusps. Some trenches, such as the New Hebrides/South Hebrides Trenches, are "U-shaped" when seen from above or on a map. Other trenches have arcs and cusps. [See Figure 83 on page 152.] What caused those shapes?

- **49. HP:** Hold a paperback book horizontally, then bend half of it downward. It bends only on a straight line. Likewise, a thick crustal plate trying to subduct would only bend on a straight line. However, all trenches curve.

Now, visualize a growing partial vacuum inside a sealed metal can, as described on page 159. Its walls will buckle inward in a variety of curved shapes. Also, the floor of the western Pacific, as it was "sucked"

Is This a Subducting Plate?

Only for those who haven't considered **the physics** of subduction or looked at **the shape** of what they think is a "plate."

The Physics: Before a plate can subduct, plates must be formed, all over the Earth. That requires cracking the entire earth's crust (which is 30–60-miles thick) into a dozen or so pieces. Then the bases of each plate must somehow be separated from their foundations—the mantle—so they can all move horizontally in different directions. A huge task! (If just one plate cannot be separated from its base, there would be a log jam. No plates could move.) *Notice how the hydroplate theory explains how all of this happened, in the first 2 hours of the flood—during the rupture phase.*

Then, to subduct, each plate must begin a very steep dive into the mantle—something that baffles geophysicists.

*The initiation of subduction remains one of the unresolved challenges of plate tectonics.*¹⁰⁴

*In spite of its importance, it is unclear how subduction is initiated.*¹⁰⁴

If subduction cannot begin, then subduction is not occurring. Sixteen other physical problems for subduction are described in Figure 98 on page 174 and Table 4 on page 176.

The Shape: We have shown on page 593 that even if subduction could begin, friction (certainly on the plate's blunt front end, but even on perfectly smooth sides) would stop subduction. Think how much more difficult subduction would be if, as shown in Figure 99, the sides of the "plate" were not smooth but had large protrusions.

This picture is only two-dimensional. With the 41,471 earthquake waves that generated it, a 3-dimensional picture could have been drawn. It would undoubtedly show hundreds of additional protrusions, each of which would lock any plate to the mantle, preventing subduction.

Then what is the dark blue object? Friction from the slightest high-pressure slippage along faults that extend down through the mantle instantly generates hot magma that melts the walls of the fault in varying degrees. This accounts for the varying thickness of what some mistakenly imagine is a subducting plate. When that magma later solidifies, it is slightly denser, so seismic waves pass through it more rapidly than the mantle and give the above picture. How much magma was produced by the friction from that extremely high-pressure slippage along all the faults through the mantle? Much more than 120 times the volume of all the water in our oceans, plus the volume of all flood basalts!

A cold plate would heat up as it dove into the mantle, so there should be a steady decrease in P-wave velocities with

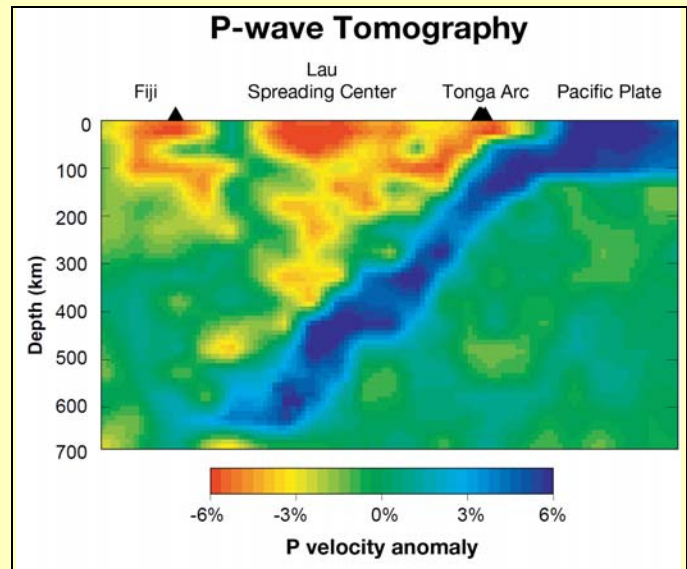

Figure 99: Seismic Tomography Image.¹⁰⁵ Hundreds of seismometers from all over the world have each recorded thousands of earthquake waves. By knowing the precise timing of each earthquake and the arrival times of each P (primary) wave at every seismometer, computers can identify narrow regions in the mantle where P waves sometimes traveled 6% faster than normal. Those regions, such as shown in blue above, are either colder—or denser—than normal. Which is it?

increasing depth. However, as you can see in the dark blue region, there is little change in P-wave velocity with depth.

Notice also that P-wave velocities are about 6% faster through the dark blue region. If that region were a cold subducting plate, its temperature should be about what it is at the base of the ocean, perhaps 36°–100°F (or 275°–310°K, in absolute degrees). The mantle's temperature 100–700 kilometers under the ocean is 1400°–2000°K. Sonic velocities (including P-wave velocities) through solids vary inversely as the square root of the absolute temperature. Therefore P-waves should travel about 400% faster through cold subducting plates, not the measured 6%. So the dark blue region appears to be mantle rock that melted along the fault and later resolidified into slightly denser rock.

Some have argued that seismic tomography allows them to see a subducting plate with their own eyes, so they don't need to think about it. They should consider not just physics and shapes, but also the global flood, because no one has seen a subducting plate, despite major efforts to see one.

*Researchers also want to get a glimpse of the subducting slab itself. ... there's a couple hundred million years of oceanic crust going down, and we don't know where it went.*¹⁰⁶

down toward the rising Atlantic, buckled downward in many curved shapes, as seen from above or on a map. When a hard spherical shell (such as the Earth's

crust or even a ping-pong ball) buckles inward, the deformation pattern is usually one of arcs and cusps.

Table 4. Subduction: Possible or Impossible?

Why Plates Cannot and Have Not Subducted	See Pages
1. A subducting plate would experience too much resistance in diving down through just the top of the mantle. The blunt front end alone would stop movement. Also, the unspecified force needed to overcome these resistances would (if a pushing force) crush the plate or (if a pulling force) pull the plate apart.	168, 172–174, 592
2. Sediments, volcanoes, and plateaus have not been scraped off “subducting” plates in trenches.	177
3. Sedimentary layers in trenches are undisturbed. These layers would be mangled if plates subducted.	177
4. No known forces are available to break the crust into plates and separate those plates from their bases.	177
5. One plate cannot even begin its dive under an adjacent plate that is 30–60-miles thick, because, as Figure 98 on page 174 shows, long cliffs would be 30–60 miles high—an impossible condition. ²⁹	177
6. Subduction cannot occur along an arc. Subduction is geometrically possible only along a straight line. (The arc-and-cusp pattern of ocean trenches shows subsidence, not subduction.)	174
7. If subducting plates produce volcanoes, 100% of the volcanoes should be on the landward side of trenches. Most are on the seaward side.	168
8. Below trenches are mass deficiencies, not mass excesses as subduction would produce.	154–154, 164, 174
9. Beneath trenches, earthquakes sometimes occur across a much broader region than the width of a plate.	172
10. Seismic tomography has not shown unambiguous subducted plates in even two dimensions. If plates subducted, seismic tomography could convincingly and dramatically show them in three dimensions.	170, 175
11. Some Benioff zones are nearly horizontal. Subducting plates should always move on a downward slope.	178
12. Thick, buoyant continents would prevent subduction.	178
13. A subducting plate would not reverse direction.	172, 178
14. Trenches and ridges do not have corresponding lengths and locations as plate tectonic theory requires. For every square mile of crust that emerges from a ridge, a square mile of crust should disappear at a trench.	177, 178
15. At three locations on Earth, a trench (and, according to plate tectonics, a descending plate) intersects a ridge (where material is supposedly rising). Material cannot be going up and down at the same time.	178
16. Ancient trenches have never been found.	177
17. Deposits of methane hydrates lie on the deep ocean floor, short but uniform distances from the continents they are supposedly subducting under. If plates are subducting, that would not be the case. Those deposits would be at various distances, and some deposits would have been swept under their overriding continent.	116, 136

No Seafloor Spreading

Notice that if plates cannot subduct, as shown in [Table 4](#), seafloor spreading at oceanic ridges is not occurring. If seafloor spreading is not occurring, the magnetic anomalies on the ocean floor are not the result of the Earth’s magnetic field flipping every several million years. Nor can theoreticians explain how Earth’s magnetic poles could reverse.

It was only after the discovery of the magnetic anomalies in the 1950s, and their false plate-tectonic interpretation in the late 1950s and early 1960s, that the plate tectonic theory became popular. Prior to that interpretation, plate tectonics was considered as doubtful as the discredited continental drift theory of Alfred Wegener.

The geoscientific community accepted the theory [of plate tectonics] after the concepts of seafloor spreading were developed in the late 1950s and early 1960s.¹⁰⁷ [See “[Does Recently Declassified Data Falsify Plate Tectonic Theory?](#)” on [page 500](#).]

Just as the maximum depression on a ping-pong ball is deeper than the depression at any of its cusps ([Figure 97](#)), so the western Pacific was initially deeper than the trench cusps. As continents sank into the mantle in the centuries after the flood, the western Pacific floor rose.

⊗ **50. PT:** Subducting plates must deform if they subduct along an arc. If they subduct along a *concave* arc, the plate will be stretched. Some experts claim to see evidence that tearing has occurred.

[Response: Other experts disagree. If tearing (tensile failure) occurs, what large force does that tearing? Then, what are the much larger horizontal forces required to crush a plate subducting along a *convex* arc, and is there any evidence that has occurred? (Saying that it must have occurred because subduction occurs is illogical.) Only if a plate could subduct along a straight line would these extreme stretching and compressing forces not be needed. Almost all trenches form an arc, not a straight line.]

Concentrated Trenches. *What concentrated so many trenches in the western Pacific?*

● **51. HP:** The continental-drift phase began when the subterranean floor became unstable and rose in what is now the Atlantic. This quickly lessened the tendency for the subterranean floor to become unstable and rise elsewhere. A corresponding depression had to occur on the opposite side of the Earth—the western Pacific.

✘ **52. PT:** It is probably a coincidence. There is no reason plates should prefer to subduct in the western Pacific.

[Response: Highly unlikely. Trench concentrations in the western Pacific are just too great. Besides, oceanic *ridges* exist in all oceans, so *trenches* should be equally dispersed. If rock rises at ridges and subducts at trenches, why is the total ridge length (46,000 miles) three times longer than the total trench length (about 15,000 miles)?¹⁰⁸ (Also, keep in mind that material supposedly exits ridges in two directions, which doubles the problem.)

Undistorted Layers in Trenches. *Sedimentary layers in trenches are usually horizontal and undistorted.*

● **53. HP:** Since the flood, sediments in trenches have settled gently onto a relatively stationary ocean floor.

If subduction occurs at trenches, the overriding plate should scrape off the layered sediments, volcanic cones, and oceanic plateaus riding on the subducting plate. Seismic reflection profiles show that trenches contain horizontal, undistorted layers with no sign of subduction. Nor are scraped-off volcanic cones collecting in trenches.

✘ **54. PT:** Yes, this is surprising. As H. W. Menard stated, *... it would seem that the sediment sliding into the bottom of the trench should be folded into pronounced ridges and valleys. Yet virtually undeformed sediments have been mapped in trenches by David William Scholl and his colleagues at the U.S. Naval Electronics Laboratory Center. Furthermore, the enormous quantity of deep-ocean sediment that has presumably been swept up to the margins of trenches cannot be detected on sub-bottom profiling records.*¹⁰⁹

Other authorities have made similar observations.¹¹⁰

Initiation. *How does a trench start to form?*

● **55. HP:** Trenches began to form as the Atlantic floor rose at the beginning of the rapid continental-drift phase. The western Pacific floor then subsided, producing horizontal compression, downward buckling, shearing (faulting), and trenches.

✘ **56. PT:** When two plates collide, the denser plate is pushed down, and subduction begins. Subduction produces trenches.

[Response: For subduction to begin, the Earth's crust must first break—a herculean task for which experts on plate tectonics admit they have no “sound quantitative” explanation.

*The initiation of subduction remains one of the unresolved challenges of plate tectonics.*¹⁰⁴

Next, for a broken plate to subduct, its entire edge, up to thousands of miles long, must be depressed at least 30 miles, the minimum thickness of these hypothetical plates. Nothing even approaching that large a topographic discontinuity has ever been seen anywhere on Earth. **Figure 98** explains why this could never happen.

Table 4 give 17 reasons subduction has not occurred.]

“Fossil” (Ancient) Trenches. *If trenches have been on Earth for hundreds of millions of years, many trenches should now be buried. Some should even have been lifted above sea level. Ancient trenches have never been found. As Fisher and Revelle noted:*

*Where are the trenches of yesteryear? Are we living in an exceptional geologic era; are the apparently young trenches of the present day unusual formations that have had no counterparts during most of geologic time? Such a speculation would be repugnant to many geologists, because it would be difficult to reconcile with the doctrine that the present is the key to the past. We must continue to search for ancient trenches—on the deep-sea floor, in the marginal shallow water areas and on the continents themselves.*¹¹¹]

● **57. HP:** Because the flood was a single, recent event, one should not expect to find ancient trenches.

✘ **58. PT:** Rocks, found at several continental locations, contain ocean floor minerals that have been compressed and deformed. They may have been scraped off a subducting plate in a trench.

[Response: That is only one interpretation. The leading edge of hydroplates would scrape up (as with the blade of a bulldozer) and deform similar sediments as they decelerated during the rapid continental-drift phase. As stated in the quotation by Menard on page 177, sediments that should be scraped off subducting plates and in trenches are not seen. If those rocks are from an ancient trench, what lifted them up?

Other. *The following details pertain primarily to one theory or the other.*

- **59. HP:** Earth's extremely large magnetic field formed as a direct consequence of the events that produced ocean trenches. [See "[The Origin of Earth's Powerful Magnetic Field](#)" on page 180.] This also explains why the crystals in the inner core are oriented in a preferred direction—toward the magnetic poles.³²

The plate tectonic theory does not address the origin of the Earth's magnetic field, although for decades schools and textbooks have taught that it is generated by a geodynamo operating in the Earth's outer core. Most experts will admit that the geodynamo theory has many problems, and many experimental efforts have not been able to produce a realistic dynamo.¹¹²

- **60. HP:** Chekunov et al. described experiments involving fracturing in small-scale models and discussed temperature and strength variations in the crust and upper mantle. Based on these considerations, they concluded that trenches and Benioff zones imply subsidence, not subduction.¹¹³
- **61. HP:** Earth's inner core spins faster than the rest of the Earth, a consequence of vertical shifts of mass within the Earth during the flood, gravitational settling, the formation of the liquid outer core, and the law of conservation of angular momentum. Even today, magma draining down from the mantle is adding angular momentum to the core. These same factors also explain why many historical records show that the Earth had a 360-day year before the flood.
- ⊗ **62. PT:** Ridges and trenches do not always correspond to each other, as they should if plates form at ridges and move toward and disappear under trenches. According to plate tectonics, about as much land area should rise from ocean ridges per unit time as descends into trenches, but the total length of all ocean ridges is three times longer than that of all ocean trenches!¹⁰⁸ Besides, material is supposedly rising out of in two opposite directions, which doubles the problem. Also, why are trenches primarily in the western Pacific Ocean, when ridges are more equally distributed over the entire Earth?
- ⊗ **63. PT:** If, as plate tectonics maintains, material is rising from the mantle at ridges and diving into the mantle at trenches, a contradiction occurs where a ridge and trench intersect.¹¹⁴ This happens at three locations in the eastern Pacific: 50.5°N latitude and 130°W longitude, 20.5°N latitude and 107°W longitude, and 46.3°S latitude and 75.7°W longitude. The same—or even closely spaced—mantle material cannot be going both up and down at the same time.

- ⊗ **64. PT:** A linear pattern of earthquakes intersecting a trench defines a Benioff zone. Most Benioff zones are steeply inclined, but one under a long portion of the west coast of South America is nearly horizontal.¹¹⁵ If these earthquakes occur along the surface of a subducting plate, no portion of the Benioff zone should be nearly horizontal, because the plate is supposedly diving through the mantle. However, consistent with the hydroplate theory, these earthquakes could originate on a nearly horizontal fault.

- ⊗ **65. PT:** Continents, being thick, buoyant, and strong, should prevent subduction. As Molnar admitted:
... the buoyancy of thick continental crust keeps it afloat. If continental lithosphere were strong enough to maintain its integrity at a subduction zone, the buoyant continental crust would not only resist being subducted, but the subducting plate would abruptly grind to a halt when the continental "passenger" reached the trench.¹¹⁶

Molnar, who believes that oceanic crust subducts, must then conclude that continental crust must not be strong enough to resist subduction. He has not shown that to be true, nor has he shown that the Earth is littered with continents torn apart as they descended into trenches. Instead, he admits that "finding a simple and accurate way to represent the deformation of continents remains a major task."¹¹⁷ If plate tectonics has been going on for a billion years, why aren't most continents wedged up (or crushed up) against trenches?

Final Thoughts

Dr. Thomas Chrowder Chamberlin, former president of the University of Wisconsin and the first head of the Geology Department at the University of Chicago, published a famous paper¹¹⁸ in which he warned researchers not to let one hypothesis dominate their thinking. Instead, they should always have or seek *multiple working hypotheses*. Chamberlin stated that by testing competing hypotheses or theories, we sharpen our analytical skills, develop thoroughness, reduce biases, and learn to discriminate and think independently, not simply memorize and conform.

Chamberlin said the danger of teaching only one explanation is especially great in the Earth sciences, where much remains to be learned. Both the plate tectonic theory and the hydroplate theory claim to explain ocean trenches, earthquakes, and the Ring of Fire. The plate tectonic theory dominates the Earth sciences. A recent survey of scientists selected it as the most significant theory of the 20th century. Undoubtedly, Darwin's theory of organic evolution would be voted as the most significant theory of the 19th century. Both dominate, despite growing recognition of their scientific problems, because

Is Africa Splitting into Two Continents?

In September 2005, an earthquake in northeast Africa (primarily Ethiopia) opened up this 40-mile-long, north-south crack, which is called the Great Rift of East Africa. GPS measurements show that the crack is widening at a rate of 0.8 inch a year, about the rate your toenails grow. Two explanations are given for how it happened.

Plate Tectonic Explanation. A plume of hot magma from the Earth's liquid outer core rose very slowly 1,770 miles up through the mantle and split Earth's crust. This is the first time humans have seen a continent breaking apart, but it must have happened multiple times, since plate tectonics began 3.8-billion years ago, because Earth's crust has been broken into many separate plates. The mantle's circulation causes those plates to slowly drift relative to each, like rafts over Earth's surface. In 10-million years, a new ocean will lie between the two pieces that were once Africa. Continental drift is happening before our eyes.

Hydroplate Explanation. The global flood began with a globe-encircling rupture that broke Earth's crust into hydroplates—plates resting on confined and compressed water. That water then escaped upward as the fountains of the great deep and flooded the entire Earth.

Thousands of vertical fractures (faults) were produced throughout the mantle and crust by (1) the sudden upward buckling of the 46,000 mile long Mid-Oceanic Ridge, (2) the downhill sliding of the hydroplates that ended in the compression event which pushed up Earth's major mountain ranges in less than an hour, and (3) the melting and 50% shrinkage of Earth's core. Other fractures were produced by the worldwide deposition of a mile-thick layer of sediments eroded by the escaping water.

Friction produced by high-pressure slippage along these faults melts rock and produces magma. Magma that is below the crossover depth then drains down into the outer core and opens up space along the fault that allows mantle blocks sliding on the almost frictionless liquid outer core) to move horizontally and cause continental drift.

That drainage expands the volume of the outer core which then exerts even greater upward pressure on the mantle blocks that are resting on the outer core. That, in turn, periodically causes upward slippage along the faults separating these mantle blocks. This cycle is ongoing.

Magma produced above the crossover depth rises, expands, and pushes mantle blocks into the space opened up between other mantle blocks, and creates hot regions, even volcanoes.

The plate tectonic explanation is incorrect, because:

1. Magma in the outer core is too dense to rise up from the outer core. (It is twice as dense as the mantle rock



Figure 100: A Segment of the 40-Mile-Long Great Rift of East Africa.

immediately above, because it is so far below the crossover depth and under such great pressure.) [See the red cells in [Table 46](#) on page 604.]

2. Plumes rising from the outer core are a fiction as explained in Item 7 on [page 166](#) and Endnote 71 on [page 188](#).
3. Other north-south cracks that parallel the crack in [Figure 100](#) have recently been discovered. They are also widening, to the bewilderment of geologists,¹¹⁹ because, if magma were to rise from the outer core, it would travel up through the mantle by the easiest path, which would be the same path made by the magma that, according to the plate tectonic theory, formed the first crack. Instead, as the hydroplate theory explains, spreading occurs along each of the many vertical faults, because friction from upward slippage melts thin amounts of rock on each side of the fault, and that magma then drains into and expands the outer core, which causes more upward slippage, and slowly opens up space for horizontal movement. This cycle continually repeats.
4. The mantle is not circulating, as explained in item 34 on [page 171](#).

schools and the media ignore competing explanations. Chamberlin warned about the comfort of conformity.

The subjects of “trenches, earthquakes, and the Ring of Fire” offer students and teachers a great opportunity. The two competing theories can be explained simply, as was done in Figures 85 and 90–92. More information can be added as student interest, time, and ability permit. Relevant topics could include fossils, volcanoes, gravity anomalies,

flood basalts, seismic tomography, arcs, cusps, tides, the core-mantle boundary, Earth’s magnetic field, the crossover depth, and many others. Students can examine and compare the evidence and tentatively decide which is the stronger theory. Teachers and parents have a simple, satisfying task: provide information, ask questions, challenge answers, and allow students the excitement of discovery.

The Origin of Earth’s Powerful Magnetic Field

Earth’s magnetic strength today is 2,000 times greater than that of all the solar system’s other rocky planets combined! No doubt, Earth had a magnetic field before the flood,¹²⁰ but how and when did the field become so large? Also, why do seismic waves pass through the inner core 4 seconds faster when traveling parallel to the axis of the magnetic poles than when traveling perpendicular to that axis?^{31, 32}

During the flood, a common, dense mineral—magnetite (Fe_3O_4)—began settling through the growing liquid outer core. (Magnetite, as its name implies, is highly magnetic if its temperature remains sufficiently below its melting temperature.) The increasing pressure on each falling magnetite crystal as it fell deeper and deeper into the liquid outer core, produced a phase change (a different crystalline structure) that increased the mineral’s melting temperature, allowing each crystal to retained its magnetic strength.¹²¹ Each falling magnetized crystal aligned itself with the Earth’s north magnetic pole, so they settled onto the growing inner core and steadily increased Earth’s magnetic field.¹²² Today, magnetite crystals and magma drain more slowly into the outer core.

In summary, before the flood, trillions upon trillions of tiny magnetite crystals were somewhat randomly oriented inside the Earth, so their magnetic strengths partially canceled each other. Since the flood, melting and gravitational settling deep in the Earth deposited many of those crystals on the solid inner core where they aligned with Earth’s growing magnetic field.¹²³ Thus, (1) Earth’s magnetic field increased greatly, and (2) crystals in the inner core are aligned parallel to the axis of the magnetic poles, allowing seismic waves today to pass faster through the core in that direction.^{31, 32}

Support for this explanation for Earth’s magnetic field comes from **geomagnetic jerks (GMJs)**, a phenomena that has perplexed physicists since their discovery in 1969. The direction and strength of Earth’s magnetic field changes slowly. However, about every 6 years,¹²⁴ the field changes abruptly over a period of months—what is called a *jerk*. Some jerks are detected on one side of the Earth but not on the other.¹²⁵ Strong GMJs correlate with strong earthquakes.¹²⁶

Small but sudden changes in the Earth’s spin rate, accompany these jerks increasing—or decreasing—the length of a day by milliseconds. The cause of GMJs has been isolated to the Earth’s core, but what is happening at the Earth’s core that explains GMJs? One expert said no one knew, and he had “no clue.”¹²⁷ So what causes GMJs?

Following a large earthquake, considerable magma and magnetite drain onto the outer core. At the Earth’s surface, GMJs are primarily felt on the side of the Earth nearest where the magnetite is deposited on the surface of the inner core. After about 6 years, the volume of magma in the outer core increases enough to push up the mantle block least locked by friction. This produces more magma, more draining magnetite, and more GMJs. It also decreases Earth’s spin rate by a few milliseconds per day for the same reason a skater spins slower if she extends her arms *away from* her spin axis.¹²⁸ [See Figure 84 on page 154.]

A Faulty Explanation. The standard, but flawed, explanation for Earth’s magnetic field is that radioactive decay heats the Earth’s core, causing the liquid outer core to convect (circulate). That movement of electrically conducting liquid supposedly creates a dynamo that maintains Earth’s magnetic field—a dynamo that could also reverse directions. This might explain the magnetic variations described on page 115. However, a dynamo shuts down if its magnetic field ever becomes zero, so how could Earth’s magnetic field reverse and pass through zero?¹²⁹ And where did the magnetic field come from to start the dynamo in the first place? This standard explanation leaves unanswered why the Earth has such a large magnetic field and why seismic waves travel so fast in one direction but not the perpendicular direction.

Actually, radioactive decay is not occurring in Earth’s core. [See “**Where is Earth’s Radioactivity?**” on page 385.] Also, the outer core’s thermal conductivity is now known to be so great that temperature differences across the depth of the core are too small to significantly drive convection. Clearly, with no convection in the liquid outer core, **there is no dynamo to generate Earth’s magnetic field.**¹³⁰

The Core Below

Plate tectonics refers to “crustal plates,” but that conveys the false idea that plates are rigid and move like rafts on a solid, but almost frictionless, mantle.¹³¹ Figure 94 on page 171 shows that plates do move, but they are not rigid. Frequently, earthquakes produce new crustal movements that define new “plates”—some very small. Plate tectonics ignores the key role of the liquid outer core, because it is so remote and has such unusual properties. Some mistakenly teach that the solid mantle (84% of the Earth’s volume) circulates like a hot, convecting liquid. The first paragraph on page 156 gives one of many reasons that cannot happen. Contrast these common but faulty plate-tectonic beliefs with the following:

The flood produced a terribly fractured Earth. As the Mid-Atlantic Ridge and Atlantic floor rose during the flood, melting and shrinkage of the inner Earth began.

This produced thousands of shear failures (or faults) throughout the crust and mantle. Many intersected the growing liquid outer core. [See “Forming the Core” on page 160.] Most faults are permanently locked by friction and the great pressures within the Earth.

*However, gravity, acting on the unbalanced Earth since the flood, causes slippage along the weakest faults. Frictional heating then produces thin films of magma along those faults. Above the crossover depth, that magma expands and tries to rise to Earth’s surface to form volcanoes or flood basalts; below the crossover depth, magma shrinks, because it is so compressible under such high pressure.¹⁹ The magma then drains, increasing in density as its pressure increases during its fall to the core. This is how much of the core formed. **Slippage along faults under the western Pacific has been misinterpreted as plates (30–60-miles thick) somehow diving into the mantle—an impossibility for each of 17 reasons given in Table 4 on page 176.***

*Magma that leaves the mantle flows up or down faults, allowing blocks on either side of the fault to move horizontally into the space vacated by the magma. That slow movement stops when enough protruding points on adjacent blocks make solid-to-solid contact with each other. Those protrusions keep the thin channels open, so magma can still flow up or down between mantle blocks. Most magma drains into the outer core. **A mantle block resting on the outer core experiences no resistance at its base when it shifts horizontally, because it is sliding on a very dense liquid—almost twice as dense as the block itself.** [See the red cells in Table 46 on page 604.] At those densities, magma cannot rise. As the outer core’s volume expands, the upward pressure on the thousands of mantle blocks increases. Eventually, slippage occurs along the weakest*

fault,⁵⁷ producing another earthquake. That slippage scrapes the solid-to-solid contacts over each other, and generates more heat and draining magma. A weak fault will probably fail again when enough liquid builds up in the outer core. Therefore, earthquakes often reoccur on the same fault at somewhat regular intervals, and the outer core is steadily expanding. Eventually, there will be many earthquakes.

*As explained on page 156, the greatest fracturing during the flood occurred under the western Pacific, directly opposite the rising Atlantic floor. Therefore, most drainage today occurs under the western Pacific, so this ongoing cycle moves mantle/crustal blocks generally toward the western Pacific. Blocks can sometimes shift in the opposite direction if magma drains from a fault in that direction. **These slow-slip earthquakes can reverse rapidly and produce tremors, because earlier (forward) movements of the blocks removed protruding obstacles from adjacent blocks.**¹³² [See Figure 95 on page 172.] Rock is removed just as sandpaper, sliding across wood, removes a thin layer of protruding wood, but at the extreme compression deep in the Earth, heat generated by slippage instantly melts the removed rock.*

*So we can see that plates are not moving like rafts on the Earth’s surface; instead, the blocks that compose the mantle and crust periodically shift. Those shifting on the outer core slide on an essentially frictionless liquid (usually toward the Pacific where drainage is greatest). The energy for all this movement comes from the magma draining into the outer core. **For every unit of heat consumed in melting a tiny but typical piece of the mantle below the crossover depth, 44 units of heat are released deep in the Earth as that magma drains into the outer core, converting its potential energy to heat.**⁴⁷ Draining magma, in turn, increases the volume of the outer core, which produces more upward pressure, more shifting along the weakest faults, more frictional melting, and more earthquakes. Runaway heating is occurring far below our feet, so powerful, global earthquakes will someday increase.*

An earthquake requires rock with a preexisting fracture (a fault). Because earthquakes occur throughout the Earth, many fractures must exist. Greater force is required to fracture a rock than to cause slippage on an existing fracture. Therefore, to explain earthquakes, one must first explain the gigantic forces that fractured rock throughout the Earth. Then, the easier slippage (earthquakes) can be addressed. Conclusion: We live on a fractured and wrecked Earth—wrecked by the flood.

References and Notes

(To locate specific authors, consult the index.)

1. Four trenches lie beyond this area shown in Figure 83: the Peru-Chile Trench, the Middle America Trench, the South Sandwich Trench, and the Puerto Rico Trench. (The latter may simply be a submarine canyon.)

Why are a few trenches not in the concentrated trench region in the western Pacific? After studying this entire chapter, especially “**Magma Production and Movement**” on page 156, you will see that major faulting (shearing) deep inside the Earth would not always have been under the western Pacific. On rare occasions it would have occurred elsewhere, such as along continent-plate boundaries where the Peru-Chile Trench and the Middle America Trench are today.

2. “[At least 19 studies have shown] *that silicate liquids are more compressible than silicate crystals,*” Carl B. Agee, “Crystal-Liquid Density Inversions in Terrestrial and Lunar Magmas,” *Physics of the Earth and Planetary Interiors*, Vol. 107, 1998, p. 63.
3. “*It is perhaps especially remarkable that some material was recovered from the depths exceeding 7000 m in the trenches, even right down to the bottom of the Philippine Trench. ... plant remnants, making them fossils [that are] rather surprising in the deep sea.*” Anton F. Bruun, “General Introduction to the Reports and List of Deep-Sea Stations,” *Galathea Report: Scientific Results of the Danish Deep-Sea Expedition Round the World 1950–1952*, editors Anton F. Bruun, S. Greve, and R. Spärck (Copenhagen: Nordlundes Bogtrykkeri, 1957), p. 15.
4. Robert L. Fisher and Roger Revelle, “The Trenches of the Pacific,” *Continents Adrift* (San Francisco: W. H. Freeman and Co., 1972), p. 15.
5. Gordon A. Macdonald et al., *Volcanoes in the Sea*, 2nd edition (Honolulu: University of Hawaii Press, 1983), p. 330.
6. Fisher and Revelle, p. 12.
7. Jane Qiu, “Expedition Probes Ocean Trench’s Deepest Secrets,” *Science*, Vol. 355, 13 January, 2017, p. 115.
8. “*... earthquakes do indeed serve to make the Earth more compact, thus decreasing its moment of inertia and, because they leave total angular momentum unchanged, increasing the rotation speed and thus decreasing the length of the day, which is what would be expected.*” John Maddox, “Earthquakes and the Earth’s Rotation,” *Nature*, Vol. 332, 3 March 1988, p. 11.

While each major earthquake suddenly causes the Earth to spin slightly faster, continuous tidal effects steadily slow the Earth’s spin. The latter effect, detected by atomic clocks, dominates over long time periods. [See pages 576–580.]

“*Meanwhile, the questions remain of why the effect of earthquakes on the Earth’s rotation should have the effect of predominantly decreasing the polar moment of inertia ...*” Ibid.

Answer: Gravity always tries to squeeze the Earth into a more spherical, compact shape. During the early stages of the global flood, the fountains of the great deep redistributed massive amounts of rock, making the Earth less spherical. The imbalance grew even more toward the end of the flood, as gravity suddenly shifted material within the inner Earth, caused rapid continental drift, and formed Earth’s three major oceans: the Atlantic, Pacific, and Indian Oceans.

Today, aftershocks follow each major earthquake, as the inner Earth adjusts locally to the earthquake’s sudden redistribution of mass near the fault. Likewise, today’s earthquakes are simply aftershocks caused by major shifts of mass during the flood.

9. “*... seismic waves passing beneath continents traveled faster than those passing beneath ocean basins.*” Richard A. Kerr, “The Continental Plates Are Getting Thicker,” *Science*, Vol. 232, 23 May 1986, pp. 933–934.
- ◆ “*Seismic models of global-scale lateral heterogeneity in the mantle show systematic differences below continents and oceans that are too large to be purely thermal in origin.*” Alessandro M. Forte et al., “Continent-Ocean Chemical Heterogeneity in the Mantle Based on Seismic Tomography,” *Science*, Vol. 268, 21 April 1995, p. 386.
10. On 25 March 1998, the largest earthquake in 4 years and one of the largest ever recorded on the ocean floor struck inside the Antarctic plate, 350 kilometers from the nearest plate boundary. [See Richard Monastersky, “Great Earthquake Shakes Off Theories,” *Science News*, Vol. 154, 5 September 1998, p. 155.] Powerful intraplate earthquakes have also occurred near Lisbon, Portugal (1755), New Madrid, Missouri (1811, 1812), and Charleston, South Carolina (1886).
11. “*It has long been known that impoundment of reservoirs, surface and underground mining, withdrawal of fluids and gas from the subsurface, and injection of fluids into underground formations are capable of inducing earthquakes.*” William L. Ellsworth, “Injection-Induced Earthquakes,” *Science*, Vol. 341, 12 July 2013, p. 142.
12. “*Now changes in local gravity resulting from large earthquakes can be detected.*” Fred F. Pollitz, “A New Class of Earthquake Observations,” *Science*, Vol. 313, 4 August 2006, p. 619.
- ◆ Shin-Chan Han et al., “Crustal Dilation Observed by GRACE After the 2004 Sumatra-Andaman Earthquake,” *Science*, Vol. 313, 4 August 2006, pp. 658–661.
13. The volume of the liquid outer core is $1.7 \times 10^{11} \text{ km}^3$, the area of the Pacific Ocean is $7.3 \times 10^7 \text{ km}^2$, and the densities of the lower mantle and outer core are 5.5 and 10.1 gm/cm^3 , respectively. The Pacific plate began subsiding within hours after the continental plates started moving away from the rising Mid-Atlantic Ridge. After the first 1% of the magma in the outer core had formed, the Pacific plate had subsided

about 30 miles (48 km), enough to prevent any interference with the sliding hydroplates.

$$\frac{7.3 \times 10^7 \times 48}{1.7 \times 10^{11}} \times \frac{5.5}{10.1} = 0.01$$

Along with this subsidence, Earth's surface water shifted violently from above the upward bulging chamber floor on the Atlantic side of the Earth onto the subsiding Pacific plate. That massive shift in weight could have pushed the inclining hydroplates past their tipping point.

- ◆ “Elsewhere, such as around the borders of the Pacific, most of the subsidence appears to have taken place by faulting.” Kenneth K. Landes, “Our Shrinking Globe,” *Bulletin of the Geological Society of America*, Vol. 63, March 1952, p. 227.
- 14. “Here we present support for a response of the El Niño/Southern Oscillation (ENSO) phenomenon to forcing from explosive volcanism ... The results imply roughly a doubling of the probability of an El Niño event occurring in the winter following a volcanic eruption.” J. Brad Adams et al., “Proxy Evidence for an El Niño-Like Response to Volcanic Forcing,” *Nature*, Vol. 426, 20 November 2003, p. 274.
- 15. “The available seismic data show that the primary stress field results from more or less horizontal tension—at right angles to the axis of the trench—at most depths.” William F. Tanner, “Deep-Sea Trenches and the Compression Assumption,” *The American Association of Petroleum Geologists Bulletin*, Vol. 57, November 1973, p. 2195.
- 16. Maya Tolstoy et al., “Breathing of the Seafloor: Tidal Correlations of Seismicity at Axial Volcano,” *Geology*, Vol. 30, June 2002, pp. 503–506.
 - ◆ “... tidal effects on earthquakes were not accepted until recently. ... The records showed high seismic activity at or just after low tide. The earthquake frequency nearly doubled at the lowest tides ...” Junzo Kasahara, “Tides, Earthquakes, and Volcanoes,” *Science*, Vol. 297, 19 July 2002, pp. 348–349.
- 17. “Tremor often happens along with slow slip, although sometimes it crops up before or after slow slip, or not at all. Occasionally tremor reverses direction for a little while. Why that happens remains a mystery.” Alexandra Witze, “Quakes in Slo-Mo,” *Science News*, Vol. 183, 23 March 2013, p. 28.
 - ◆ Garry Rogers and Herb Dragert, “Episodic Tremor and Slip on the Cascadia Subduction Zone: The Chatter of Silent Slip,” *Science*, Vol. 300, 20 June 2003, pp. 1942–1943.
 - ◆ “But so far, no one can explain why these slow earthquakes happen or what they portend.” Carrie Arnold, “Let’s Take It Slow,” *Discover*, April 2014, p. 16.
- 18. Mark D. Zoback, “State of Stress and Crustal Deformation Along Weak Transform Faults,” *Philosophical Transactions of the Royal Society of London*, Vol. 337, 15 October 1991, pp. 141–150.
- 19. “The basaltic magma could not ascend from a position deeper than 200 km in the Earth’s interior.” Satoru Urakawa et al., “Anomalous Compression of Basaltic Magma,” *Research Frontiers 2006*, p. 114. Also available at www.spring8.or.jp/pdf/en/res_fro/06/113-114.pdf.
- ◆ “Magmas are normally less dense than coexisting crystals at atmospheric pressure, but they are more compressible than crystals. More than two decades of experimental studies have shown that the density of magmas can be higher than that of coexisting crystals at high pressure.” *Ibid*, p. 113.
- ◆ When the mineral perovskite (Mg,Fe)SiO₃ melts at high (mid-mantle) pressures, the mineral’s iron and magnesium preferentially leave the solid and enter the melt, making the magma denser. [See Ryuichi Nomura et al., “Spin Crossover and Iron-Rich Silicate Melt in the Earth’s Deep Mantle,” *Nature*, Vol. 473, 12 May 2011, pp. 199–202.]
- ◆ These experimental results, by themselves, should kill the idea that the mantle as a whole circulates as a convecting fluid.
- ◆ Magma will dissolve certain material as it rises or sinks. If denser material is dissolved, its rise will be slowed or stopped. If volatiles or lighter material is dissolved, the magma rise will increase or maybe rise explosively.
- 20. Thanks to Kevin S. Elam, Nuclear Engineer, for pointing this out to me on 10 January 2018.
- 21. A concentrated load on a thick solid (such as the Earth) produces stresses inside the solid. The stresses spread out laterally, in proportion to their depth below the surface.
- 22. Rocks deep inside the Earth are under high and fairly uniform compressive stresses. As explained on page 156, such solids, if they fail (break), will fail by shearing. At each point inside the Earth, the maximum shearing stress occurs on a plane oriented 45° to the planes of principal stress. The principal stresses produced by the rising of the Atlantic floor and the downward pull on the Pacific plate are approximately vertical and horizontal. Therefore, maximum shearing stress—and Benioff zones—will occur at about a 45° angle to the horizontal. For more information, consult any introductory textbook on “strength of materials”; look for the subject of “Mohr’s Circle.”

One can also conclude that the principal stresses that produced Benioff zones had to be applied suddenly. Had they been applied over many years, slow deformations, called *creep*, would have removed the shearing stresses.
- 23. Movements within the mantle during and soon after the flood would have generated much heat and melting. Denser elements (such as nickel and iron) would have settled gravitationally, releasing even more heat which, in turn, melted other parts of the mantle, allowing more gravitational settling. This would explain why (a) temperatures inside the Earth increase with depth, (b) the Earth has a core, (c) the outer core is a liquid while the inner core is a solid, (d) denser elements are concentrated nearer the center of the Earth, (e) the inner core spins faster than the rest of the Earth, (f) many early cultures thought the Earth had a 360-day year (Endnote 35), and (g) Earth’s density almost doubles as one passes down through the core-mantle boundary. [See the highlighted red cells on page 604.]

Evolutionists say the Earth formed by meteoritic bombardment. While meteoritic bombardment might explain (a)–(d) above, it is contradicted by (e)–(g). Also, meteoritic

bombardment would melt the entire Earth several times over and create other problems. [See **“Consequences of Evolving Earth by Meteoritic Bombardment”** on page 609.]

Had that occurred, we would not find dense, nonreactive elements, such as gold, at the Earth’s surface. But we do! Besides, granite rocks have never melted. [See **“Geothermal Heat”** on page 118.] A molten Earth, after billions of years of cooling, would not produce the temperature patterns we see inside the Earth. [See **“Rapid Cooling”** on page 41.] Meteoritic bombardment would also add too much xenon to the Earth’s atmosphere. [See **“Molten Earth?”** on page 28 and page 87.] And finally, meteoritic bombardment presupposes the prior existence of meteoroids, whose origin, as currently taught, has many problems. [See pages 337–374.] Belief in a once-molten Earth has led many to believe that the Earth is billions of years old.

24. *“Two deep holes, drilled on opposite sides of Eniwetok Atoll, reached the basement below the cap of Recent to Eocene limestone at depths of 4,610 and 4,158 feet.”* Seymour O. Schlanger, *Subsurface Geology of Eniwetok Atoll*, Geological Survey Professional Paper 260–BB (Washington, D.C.: United States Government Printing Office, 1963), p. 991.
 - ◆ Harry S. Ladd, “Drilling of Eniwetok Atoll, Marshall Islands,” *American Association of Petroleum Geologists Bulletin*, Vol. 37, October 1953, pp. 2257–2280.
25. See **“Volcanic Gases”** on page 262.
26. *“Our main conclusion is that abyssal-hill-like topography may result from continuous stretching of a brittle layer.”* W. Roger Buck and Alexei N. B. Poliakov, “Abyssal Hills Formed by Stretching Oceanic Lithosphere,” *Nature*, Vol. 392, 19 March 1998, p. 275.
27. S. P. Kelley and J.-A. Wartho, “Rapid Kimberlite Ascent and the Significance of Ar-Ar Ages in Xenolith Phlogopites,” *Science*, Vol. 289, 28 July 2000, pp. 609–611.
 - ◆ Sylvie Demouchy et al., “Rapid Magma Ascent Recorded by Water Diffusion Profiles in Mantle Olivine,” *Geology*, Vol. 34, June 2006, pp. 429–432.
28. Jesse F. Lawrence and Michael E. Wysession, “Seismic Evidence for Subducted-Transported Water in the Lower Mantle,” *Earth’s Deep Water Cycle*, editors Steven Jacobsen and Suzan van der Lee (Washington, D.C.: American Geophysical Union Monograph, 2006), pp. 251–261.
29. See **“Highly Compressed Solids”** on page 608.
30. We sometimes see this on a small scale when soil below a concrete slab settles or becomes more compact. Without support, the slab cracks vertically, and one side of the slab settles below the other. If the slab were also compressed horizontally, as was the subsiding Pacific hydroplate, the crack would depart from the vertical, at angles comparable to those of Benioff zones. Sediments blanketing the crack would take the shape of a trench.
31. *“... strong evidence that seismic waves traveling through the inner core along the axis of the magnetic poles complete their trip through Earth about four seconds more quickly than do*

waves traveling from one side of the equator to the other.” Susan Kruglinski, “Journey to the Center of the Earth,” *Discover*, June 2007, p. 55.

32. Jeff Hecht, “The Giant Crystal at the Heart of the Earth,” *New Scientist*, 22 January 1994, p. 17.
 - ◆ *“In the mid-1980s, scientists from Harvard University first noticed an unusual feature of Earth’s core: Seismic waves tended to travel fastest when they paralleled Earth’s axis of rotation. Their speed dropped by as much as 3 percent when the waves moved perpendicular to the rotation axis. The seismologists who discovered this asymmetry explained it by suggesting that the iron crystals in the core point toward the poles and thus transmit seismic waves fastest when they travel that way. This pattern may develop from the way Earth’s magnetic field orients the crystals that solidify on [or that settle on] the surface of the inner core.”* Richard Monastersky, “Earth’s Core Out of Kilter,” *Science News*, Vol. 145, 16 April, 1994, p. 250.
- Regardless of how the solid crystals arrived at the surface of the inner core, they are aligned with Earth’s magnetic field. Therefore, those crystals must have had their own magnetic field, which means that each crystal added to Earth’s magnetic field despite the high temperatures. [See **“The Origin of Earth’s Powerful Magnetic Field”** on page 180.]
33. Xiaodong Song and Paul G. Richards, “Seismological Evidence for Differential Rotation of the Earth’s Inner Core,” *Nature*, Vol. 382, 18 July 1996, pp. 221–224.
 34. For the reasons explained in Figure 84 on page 154, the growing inner core had more angular momentum per unit volume than the same volume of the inner Earth had before the core began to form. Because angular momentum is conserved, the rest of the Earth had to lose a like amount of angular momentum. That means that as the inner core was forming after the flood, the outer Earth’s spin rate slowed for some unknown period(s) of time. Days would have been slightly longer for one or more short time intervals.
 - ◆ *“Two years ago, a pair of seismologists discovered evidence that the inner core is dancing to its own beat, spinning measurably faster than the rest of the planet. ... Since then, two other studies have bolstered the concept of an independently rotating inner core ...”* Richard Monastersky, “The Globe Inside Our Planet: Earth’s Inner Core Is Turning Out To Be an Alien World,” *Science News*, Vol. 154, 25 July 1998, p. 58.
 - ◆ John E. Vidale et al., “Slow Differential Rotation of the Earth’s Inner Core Indicated by Temporal Changes in Scattering,” *Nature*, Vol. 405, 25 May 2000, pp. 445–447.
 - ◆ *“Our results confirm that Earth’s inner core is rotating faster than the mantle and crust at about 0.3° to 0.5° per year.”* Jian Zhang et al., “Inner Core Differential Motion Confirmed by Earthquake Waveform Doublets,” *Science*, Vol. 309, 26 August 2005, p. 1357.
 - ◆ The inner core’s spin should be slowing relative to the rest of the Earth—but very slowly, because the resisting outer core is a liquid and the inner core is so massive.



PREDICTION 12: When greater precision is achieved in measuring the inner core's rotational speed, it will be found to be slowing relative to the rest of the Earth.

Because the inner core is still spinning slightly faster than the rest of the Earth, friction must be slowing the spin of the inner core. If the Earth were billions of years old, why hasn't the inner core stopped spinning relative to the rest of the Earth? Clearly, the Earth is not billions of years old, and events of the flood that formed the inner and outer core happened only about 5,000 years ago.

35. When the flood began, the year likely had 360 days.

- ◆ *“Discovered calendars from civilizations around the world universally reckoned the year as consisting of 360 days, with 12 months of 30 days each.”* Thomas Mitchell, preface to *The Ancient 360 Day Year*, by Dale W. Wong (Charleston, South Carolina: Advantage Media Group, 2006).

- ◆ Velikovsky showed—from writings of the Persians, Incas, Egyptians, Chinese, Chaldeans, Assyrians, Babylonians, Hebrews, Greeks, Hindus, Romans, Aztecs, Mayas, and Peruvians—that a 360-day calendar prevailed in much of the ancient world. [See Immanuel Velikovsky, “The Year of 360 Days,” in *Worlds in Collision* (Garden City, New York: Doubleday & Company, Inc., 1950), pp. 330–359.]

Velikovsky thought that gravitational encounters with Venus and Mars altered Earth's orbit and produced our 365-day year. Those promoting this idea could have demonstrated its feasibility with a computer simulation. They have not. Besides, Carl Sagan demolished Velikovsky's explanation in “An Analysis of Worlds in Collision.” [See *Scientists Confront Velikovsky*, editor Donald Goldsmith (Ithaca, New York: Cornell University Press, 1977), pp. 41–104.]

- ◆ Early Egyptians assumed a 360-day year, until they realized that the Nile was flooding later and later each year according to that calendar. Because Egypt's earliest settlers probably would not have adopted a 360-day year while in Egypt, they presumably brought that outdated understanding with them. [See J. Norman Lockyer, *The Dawn of Astronomy* (Cambridge, Massachusetts: The M.I.T. Press, 1964), pp. 243–248.]

- ◆ Babylonian astronomers, thousands of years ago, divided a circle into 360 degrees. Why did they choose 360, instead of something easier, such as 100 or 1,000? Probably because a year had 360 days before the flood—one degree for each day of the year. This would have been the average daily motion of the Sun among the stars, a relatively easy measurement.

If so, either Earth's spin rate or its orbital period around the Sun increased during the flood. Increasing Earth's orbital period requires a large, unknown energy source; increasing the spin rate does not, so the spin rate probably increased.

- ◆ See paragraph 6 on page 489 for an insight from the most detailed record of a year in very ancient times.

36. *“The kinetic energy ($\sim 5 \times 10^{38}$ ergs) released in the largest impacts (1.5×10^{27} g at 9 km/sec) would be several times*

greater than that required to melt the entire Earth.” George W. Wetherill, “Occurrence of Giant Impacts during the Growth of the Terrestrial Planets,” *Science*, Vol. 228, 17 May 1985, p. 879.

37. *“Using constraints from experiments, simulations, and theory, we show that spontaneous crystallization in a homogeneous liquid iron alloy at Earth's core pressures requires a critical supercooling of order 1000 K, which is too large to be a plausible mechanism for the origin of the Earth's inner core.”* Ludovic Huguet, et al. “Earth's Inner Core Nucleation Paradox,” *Earth and Planetary Science Letters*, Vol. 487, 1 April, 2018, p. 9.

These authors, trying to solve this “Core Nucleation Paradox,” wonder if a large chunk of the relatively cold mantle, broke off, fell into the hot liquid core, sank, and began the solidification of the inner core. Because the mantle is less dense than the hot liquid in the core, a piece of the mantle would not sink, but could only float. Pieces of the mantle would remain pressed against the bottom of the mantle.

38. *“Highly siderophile (iron-loving) elements (Re, Os, Ir, Ru, Rh, Pt, Pd, and Au) must have been added to the mantles of Earth, the Moon, and Mars after their iron cores formed; otherwise the mantles would be devoid of these elements, which tend to be segregated to the core.”* Christopher W. Dale, “Coming Late to the Planetesimal,” *Science*, Vol. 336, 6 April 2012, p. 10.

39. *“The shear-wave velocity (V_s) reveals a softer inner core composition than previously thought.”* Jessica C. E. Irving, “Earth's Soft Heart,” *Science*, Vol. 362, 19 October, 2018, p. 294.

- ◆ Hrvoje Tkalčić and Thanh-Son Pham, “Shear Properties of Earth's Inner Core Constrained by a Detection of J Waves in Global Correlation Wavefield,” *Science*, Vol. 362, 19 October, 2018, p. 329.

40. Exactly where on the 46,000-mile-long rupture this instability first occurred depended on several factors. It was the point where the forces acting in one direction overcame the shearing strength of the rock inside the Earth.

41. Cliff Frohlich, “Deep Earthquakes,” *Scientific American*, Vol. 260, January 1989, p. 52.

42. Shallow earthquakes may involve another phenomenon besides the mechanism explained in Figure 91. Trapped subterranean water, unable to escape during the flood, slowly seeps upward through cracks and faults formed during the crushing of the compression event. (Seismographs on the Pacific Ocean floor have measured tremors from such seepings.)¹⁶ The higher this water migrates through a crack, the more the water's pressure exceeds that in the walls of the crack trying to contain it. Consequently, the crack spreads and lengthens. (So, before an earthquake, the ground often bulges slightly, water levels sometimes change in wells, and geyser eruptions may become more irregular.) Simultaneously, stresses build up in the crust, again driven ultimately by gravity and mass imbalances produced by the flood. Once compressive stresses have risen enough, the cracks have grown enough, and the frictional locking of cracked surfaces has diminished enough, sudden movement occurs. Water acts as a lubricant. (Therefore,

large temperature increases are not found along the San Andreas Fault.) Sliding friction instantly heats the water, converts it to steam at an even higher pressure, and initiates a runaway process, one type of *shallow earthquake*.

43. “[Deep earthquakes] *have posed a fruitful puzzle since their discovery 60 years ago. How can rock fail at the temperatures and pressures that prevail hundreds of kilometers down?*” Frohlich, p. 48.
44. Z. Altamimi et al., “A New Release of the International Terrestrial Reference Frame Based on Time Series of Station Positions and Earth Orientation Parameters,” *Journal of Geophysical Research*, Vol. 112, 2007, pp. 1–19.
- ◆ “*The world is smaller than we thought - by five millimeters. That is the conclusion of an international project to measure the diameter of the Earth. The last such measurement was made in 2000.*” Damian Carrington, “Honey, We Shrunk the Earth,” *New Scientist*, 6 July 2007, p. 15.
45. “*I favor contraction because it can be adapted to explain so many puzzling features in geology that it becomes a veritable panacea.*” Landes, p. 226.
46. Five measured points on the ocean floor moved 16–79 feet (5–24 meters) horizontally in the same general direction—toward the epicenter. Vertical movements on the ocean floor and on Japan were much smaller; some points rose and others dropped. [See Mariko Sato et al., “Displacement above the Hypocenter of the 2011 Tohoku-Oki Earthquake,” *Science*, Vol. 332 17 June 2011, p. 1395.]

Those points probably rose because magma droplets could escape from their tiny pockets before or during the earthquake and pool elsewhere, thereby lifting surfaces. Below 410-mile depths, where earthquakes do not occur, the solid encasement plastically deforms before magma droplets can escape. For more on this, see “**Liquid Droplets in Hot Deep Rock**” on page 164.

47. The heat required to melt a tiny piece of rock of mass m is mL , where L is the heat of fusion. After that mass drains along a fault down through the mantle from a high elevation h_2 where the acceleration due to gravity is g_2 to a low elevation h_1 where the acceleration due to gravity is g_1 ,

$$m g_2 h_2 - m g_1 h_1$$

units of potential energy will be released as heat. That drainage occurs down vertical faults in the mantle, into the outer core. The ratio of heat released to heat expended in melting the mass is

$$\frac{m g_2 h_2 - m g_1 h_1}{m L} = \frac{g_2 h_2 - g_1 h_1}{L}$$

If h_2 is the height above the center of the Earth of a point halfway between the crossover depth and the top of the

outer core, and h_1 is the radius of the outer core, then using [Table 46 on page 604](#)

$$h_2 = 4771 \times 10^5 \text{ cm} \quad \text{and} \quad g_2 = 1004.7 \text{ cm/sec}^2$$

$$h_1 = 3493 \times 10^5 \text{ cm} \quad \text{and} \quad g_1 = 869.9 \text{ cm/sec}^2$$

(In [Table 45 on page 603](#), $L \approx 4 \times 10^9$ ergs/gm.) The ratio of heat released by draining magma to heat consumed in melting rock along a fault becomes

$$\frac{(1004.7 \times 4771 - 869.9 \times 3493) \times 10^5}{4 \times 10^9} = 44$$

Even more heat is released throughout the mantle as the tiny pockets, that held the magma droplets, collapse.

48. Have earthquakes increased since the year 2000? The United States Geological Survey reports “*As more and more seismographs are installed in the world, more earthquakes can be and have been located. However, the number of large earthquakes (magnitude 6.0 and greater) has stayed relatively constant.*” [“Earthquake Facts and Statistics,” <http://earthquake.usgs.gov/earthquakes/eqarchives/year/eqstats.php>]

Better global communications have made us more aware of earthquakes and their destruction. This has led some to believe that earthquakes are increasing. Nevertheless, earthquakes will someday increase substantially, because heat is building up inside the Earth and the shrinkage of rock that melts below the crossover depth increases stresses in the crust and upper mantle. Also, these microscopic movements inside the Earth generate heat thousands of times faster than heat escapes at the Earth’s surface. This increasing heat melts rock, especially along the relatively hot walls of faults extending from trenches down to the liquid outer core. That melt then lubricates and facilitates further internal movements. [See Endnote 47.]

49. “*In this paper we summarize and reassess a variety of geoscience data sets and show that a substantial part of the southwest Pacific Ocean consists of a continuous expanse of continental crust.*” Nick Mortimer, et al., “Zealandia: Earth’s Hidden Continent,” *Geological Society of America Today*, Vol. 27, March-April, 2017, p. 2.
50. “*The presence of continental-type crust in the oceans where oceanic crust might be expected has been recognized from seismic information by a number of authors.*” J. M. Dickins et al., “Past Distribution of Oceans and Continents,” *New Concepts in Global Tectonics*, editors S. Chatterjee and N. Hotton III (Lubbock, Texas: Texas Tech University Press, 1992), p. 193.
- ◆ “*Much sialic [continental or granitic] material appears beneath the oceans and we remain skeptical as to the distinction between what is designated continental and oceanic crust. We are surprised and concerned for the objectivity and honesty of science that such data can be overlooked or ignored.*” Dickins et al., p. 198.

“*Miller (1970), on the basis of structural trends of pre-Mesozoic orogens [folded and faulted mountains], concluded a former sialic (continental) [granitelike] crust, which has now*

disappeared, was present west of the present coast of Chile." Ibid., p. 195.

- ◆ *"Possible presence of continental crust under the ocean has been postulated by Bullin (1980) and Orlenok (1983). They stated the idea that 'the oceanic crust is thin and graniteless' is a mistake."* D. R. Choi et al., "Paleoland, Crustal Structure, and Composition under the Northwestern Pacific Ocean," *New Concepts in Global Tectonics*, editors S. Chatterjee and N. Hotton III (Lubbock, Texas: Texas Tech University Press, 1992), p. 187.
The unusual seismic characteristics of this layer in the northwestern Pacific have been noted earlier and called "Oceanic Layer 3." Drilling has not been deep enough to reach it.
 - ◆ *"This 6.5- to 6.8-km/s layer [west of Sumatra] may be either lower continental (granitic) crust or thickened oceanic layer 3. ... Although the 6.5- to 6.8-km/s velocity is high for lower continental (granitic) crust, the large thickness of this layer suggests that it is continental crust, ..."* R. M. Kieckhefer et al., "Seismic Refraction Studies of the Sunda Trench and Forearc Basin," *Journal of Geophysical Research*, Vol. 85, No. B2, 10 February 1980, pp. 863, 873.
 - ◆ *"The presence of continental crust in the northwestern Pacific casts doubt over the validity of the use of magnetic anomalies for determination of spreading age and rate ... These anomalies are located within the area of continental crust. They appear to coincide with the major fracture patterns accompanied with intrusives ..."* Choi et al., p. 188.
 - ◆ *"This provides unequivocal evidence of continental crust in Elan Bank. ... The garnet-biotite gneiss, in particular, indicates continental crust at this south Indian Ocean location."* Shipboard Scientific Party, "Leg 183 Summary, Kerguelen Plateau-Broken Ridge: A Large Igneous Province," *Proceedings, Ocean Drilling Program, Initial Reports*, 183, editors M. F. Coffin et al. (College Station, Texas: ODP, 2000), pp. 1–101.
Three other papers describing this expedition's amazing discoveries of traces of continental crust are in the *Journal of Petrology*, Vol. 43, July 2002, pp. 1105–1139.
 - ◆ *"Continental basement is known to outcrop at the base of the Rama ridge, the Lucipara ridge (site 304) and the Tukang Besi ridge (site 301)."* [These ridges, between Australia and Asia, are typically two or more miles below sea level.] Christian Honthaas et al., "A Neogene Back-Arc Origin for the Banda Sea Basins: Geochemical and Geochronological Constraints from the Banda Ridges (East Indonesia)," *Tectonophysics*, Vol. 298, 10 December 1998, p. 311.
 - ◆ *"Bathymetry and seismic profiles suggest that continental crust forms the floor of the trenches all the way around the bend from Timor to Seram ..."* Robert McCaffrey, "Active Tectonics of the Eastern Sunda and Banda Arcs," *Journal of Geophysical Research*, Vol. 93, No. B12, 10 December 1988, pp. 15, 177.
51. L. Don Leet and Sheldon Judson, *Physical Geology*, 4th edition (Englewood Cliffs, New Jersey: Prentice-Hall, Inc., 1971), p. 420.
 52. Macdonald et al., *Volcanoes in the Sea*, p. 328.
 53. Earth's spin makes the Earth slightly nonspherical. Taking that effect into account would not alter any conclusions in this chapter.
 54. *"... the tendency of earthquakes [is] to make the Earth rounder, and to pull in mass toward the centre of the Earth."* B. Fong Chao and Richard S. Gross, "Changes in the Earth's Rotation and Low-Degree Gravitational Field Induced by Earthquakes," *Geophysical Journal of the Royal Astronomical Society*, Vol. 91, 1987, p. 569.
"Why do earthquakes strive towards a rounder Earth? [Gravity strives for a rounder Earth. Gravity also drives earthquakes.] Or, conversely, does the Earth's non-sphericity have any influence on the earthquake mechanism?" Ibid., p. 594. [It has everything to do with earthquakes and shifting continental plates. The next question one should ask is, "What caused the nonsphericity?" Answer: The flood.]
 55. *"Annual financial losses caused by earthquakes over the world are estimated at 150–250 billion US dollars. Strong earthquakes lead to hundreds of thousands of victims every year."* University College London, "Detection and Monitoring of Earthquake Precursors: TwinSat, a Russian-UK Satellite Project," www.ucl.ac.uk/mssl/current-projects/formative-projects/twin-sat/twinsat-details.
 56. Erik Vance, "Earthquakes in the Sky," *Scientific American*, Vol. 319, pp.45–49.
 57. As more and more magma drains into the outer core, the blocks least anchored to adjacent blocks by friction are lifted, so the topography at the core-mantle boundary should be rough. Seismic studies have confirmed this.
Models with a root mean square core-mantle-boundary topography of 250 to 350 meters and correlation length of 7 to 10 kilometers explain the main features of the data. Paul S. Earle and Peter M. Shearer, "Observations of PKKP Precursors Used to Estimate Small-Scale Topography on the Core-Mantle Boundary," *Science*, Vol. 277, 1 August 1997, p. 667.
Therefore, *mantle blocks have horizontal dimensions of about 7 to 10 kilometers.* This implies that Earth's mantle may have millions of blocks, each separated by vertical faults.
If the liquid outer core played no role in earthquakes or had been circulating for billions of years, the core-mantle boundary should be quite smooth. It is not.
 58. Two powerful earthquakes struck near Mexico City just 12 days apart: an 8.1 magnitude quake on 7 September 2017 that killed 95 people and a 7.1 earthquake on 19 September 2017 that killed 370 people.
Because those earthquakes were only 12 days apart and relatively near each other, most people suspected that the first earthquake trigger the second. However, the experts concluded that the two quakes were too far apart (650 kilometers or 400 miles) for the stresses released by the first quake to cause the second quake, and the 12-day interval was too long for the shaking of the first to trigger the second. [See Alexandra Witze, "Deadly Mexico Quakes Not Linked," *Nature*, Vol. 549, 28 September 2017.]

What these experts are missing is that the source of the stresses was not at the Earth's surface but far below—in the expanding outer core that produces slips along the weakest vertical fault beneath both epicenters. The imbalance caused by each slip then produced earthquakes with a variety of movement directions.

The second quake was not an aftershock, because 32 years earlier that same region experienced an 8.0 earthquake that killed 10,000 people. What the three earthquakes have in common is their region which implicates a deep fault that periodically slips, and a common energy source—the slowly expanding outer core.

59. Seismologists have observed this repeating, almost periodic, pattern for centuries without knowing its underlying cause. Tragically, heat is continually building up inside the Earth, so earthquakes will increase. How fast is uncertain.
60. During these tiny implosions, not all solid points move inward with perfect spherical symmetry. If we visualize a hollow spherical shell collapsing, one side of the shell will begin the breakup. If the collapse begins at the 6 o'clock (bottom) position, the rock above could be lifted, producing a jolting uplift at the Earth's surface.
61. The piezoelectric effect is explained in Figures 209–212 on pages 391–392.
62. *"The epicentral distance [where electrical signals were detected days before an earthquake] was 120 km, and the earthquake magnitude was 4.5. ... the earthquake with magnitude 6.1 [had electrical anomalies] at the distance 130 km from the epicenter. ... for earthquakes close to 7.0 it is at least 1400 km."* Sergey Pulnits and Kirill Boyarchuk, *Ionospheric Precursors of Earthquakes* (New York: Springer-Verlag, 2004), pp. 14–15.

As we would expect, greater stresses appear to produce more powerful electrical effects and earthquakes.

63. See for example **"Earthquakes and Electricity"** on page 387.
64. Paul Rincon of the British Broadcasting Company reports: *One study looked at over 100 earthquakes with magnitudes of 5.0 or larger in Taiwan over several decades. The researchers found that almost all of the earthquakes down to a depth of about 35 km were preceded by distinct electrical disturbances in the ionosphere.* <http://news.bbc.co.uk/2/hi/7435324.stm>, 5 June 2008
65. Similar, but possibly less advanced efforts, are being undertaken in China, Mexico, Italy, Kazakhstan, and the United States (at Stanford University).
66. The French DEMETER satellite detected a significant change in electron concentration in the ionosphere 3 days before the Haitian 7.0 earthquake (2010) and 7 days before the Samoa 8.0 earthquake (2009). DEMETER was terminated in December 2010 after successfully completing its objectives. The French have no plans to continue the program.
67. University College London.
68. As has been frequently shown in this book, scientific errors often result from seeing a correlation and jumping to a

conclusion that one of the correlated variables caused the other. Maybe it was the other way around, or perhaps a third (but unknown) variable caused the correlation—or the correlation is spurious. Unless one first understands the forces, energy, and mechanism, the imagined cause will often be wrong and will only produce an expensive "wild goose chase."

The following earthquake precursors are prime examples that have wasted resources and spawned many false hypotheses: strange animal behaviors, changing water levels in wells, emissions of radon gas from the ground, changes in the velocity of certain seismic waves, ground uplift and tilt, a sharp increase in the number of tiny earthquakes, and electromagnetic effects in the Earth and atmosphere. Failure to identify the root cause of earthquakes has produced costly and embarrassing false alarms.

The hydroplate theory begins with one well-established cause: a large volume of water under the crust. [See **"The Hydroplate Theory: Key Assumptions"** on page 124.] From that starting point, 25 major mysteries of the Earth and solar system are explained. In Part II of this book, eight of those 25 features are explained in separate chapters that go into great detail and show hundreds of supporting evidences such as the origin of black smokers, radioactivity, crystalline material in comets, and dozens of tiny moons that were captured by planets (an astronomical puzzle).

Once one understands how the Earth was destroyed during the flood, one can see why stresses *periodically* build up inside the Earth and are the root cause of earthquakes (their various precursors) *and volcanoes*. Those stresses sometimes produce frictional heating, change water levels in wells, and generate piezoelectric effects. The piezoelectric effects, in turn, produce varying electrical signals which probably account for some strange animal behaviors. (Later you will see why powerful stresses during the flood produced radon gas that earthquake stresses sometimes release from deep rock.)

69. "Tiny 3-D Images from Stanford and SLAC Shed Light on Origin of Earth's Core," *Stanford University News*, 16 December 2010, p. 1.
 - ◆ Will Hunt, "Creating a Piece of Middle Earth," *Discover*, July/August 2011, p. 45.
70. Philip Campbell, "Gravity Changes before Quake Hits," *Nature*, Vol. 540, 1 December 2016, p. 10.
 - ◆ Changes in the gravity at the epicenter have been detected months before major earthquakes. [See "Gravity Tracking of a Great Earthquake," *Science*, Vol. 361, 10 August 2018, p. 566.
71. N. Petford et al., "Granite Magma Formation, Transport and Emplacement in the Earth's Crust," *Nature*, Vol. 408, 7 December 2000, p. 669–673.
72. Shannon Hall, "The Molten Mechanics of Inner Earth," *Scientific American*, December 2015, p.21.
73. Calculations are sometimes put forth in an attempt to show that plumes can rise through the mantle. Usually assumed are unrealistically low values for the mantle's viscosity and density or unrealistically high values for the plume's initial

temperature and volume. These claims take the position, “We know flood basalts came from the outer core (where most magma resides), so here is how it must have happened.” Others, looking at the physics involved and using the most reasonable numbers, admit they don’t understand how enormous volumes of flood basalts could rise through the mantle. My calculations show that a magma plume rising buoyantly and melting its way up from the core-mantle boundary would initially have to exceed the Earth’s volume for just one drop of magma to reach the Earth’s surface. Others, cited below, have reached similar conclusions.

- ◆ *“A simple calculation shows that if ascent is governed by Stoke’s law, then the great viscosity of the lithosphere (about 10^{25} poise, if it is viscous at all) ensures that the ascent velocity will be about ten thousand times smaller than that necessary to prevent solidification. A successful ascent could be made only by unrealistically large bodies of magma.”* Bruce D. Marsh, “Island-Arc Volcanism,” *Earth’s History, Structure and Materials*, editor Brian J. Skinner (Los Altos, California: William Kaufman, Inc., 1980), p. 108.
- ◆ *“The question of where the magma comes from and how it is generated are the most speculative in all of volcanology.”* Gordon A. Macdonald, *Volcanoes* (Englewood Cliffs, New Jersey: Prentice-Hall, Inc., 1972), p. 399.
- ◆ *“All the evidence that has been used so far to support the plume model—geochemical, petrological, thermal, topographic—is equivocal at best, if indeed not contrary. The plume idea is ad hoc, artificial, unnecessary, inadequate, and in some cases even self-defeating, and should be abandoned.”* H. C. Sheth, “Flood Basalts and Large Igneous Provinces from Deep Mantle Plumes: Fact, Fiction, and Fallacy,” *Tectonophysics*, Vol. 311, 30 September, 1999, p. 23.
- ◆ *“There are no chemical or isotopic data that require deep-plume origins or anomalously high temperatures, and no reliable seismic-tomography results have ever revealed a plume.”* Gillian R. Foulger and Warren B. Hamilton, “Plume Hypothesis Challenged,” *Nature*, Vol. 505, 30 January 2014, p. 618.
- ◆ *“Deep narrow thermal plumes are unnecessary and are precluded by uplift and subsidence data. The locations and volumes of ‘midplate’ volcanism appear to be controlled by lithospheric architecture, stress and cracks.”* Don L. Anderson, “The Thermal State of the Upper Mantle; No Role for Mantle Plumes,” *Geophysical Research Letters*, Vol. 27, 15 November 2000, p. 3623.
- 74. *“The plume hypothesis survived largely as a belief system and had to be extensively modified to account for unexpected observations.”* G. R. Foulger and J. H. Natland, “Is ‘Hotspot’ Volcanism a Consequence of Plate Tectonics?” *Science*, Vol. 300, 9 May 2003, p. 921.
- ◆ *“The textbook explanation for intraplate volcanism by fixed hot spots is either entirely wrong or insufficient to explain these phenomena.”* Anthony A. P. Koppers and Hubert Staudigel, “Asynchronous Bends in Pacific Seamount Trails: A Case for Extensional Volcanism?” *Science*, Vol. 307, 11 February 2005, p. 906.

- 75. Ian McDougall claimed scientific support for this idea in 1964. [See Ian McDougall, “Potassium-Argon Ages from Lavas of the Hawaiian Islands,” *Geological Society of America Bulletin*, Vol. 75, February 1964, pp. 107–128.] He dated volcanoes on seven Hawaiian islands and said that without exception they increase in age from southeast to northwest, just as would happen if the Pacific plate drifted toward the northwest at 10–15 cm/year. Why then do other volcanic chains show no such age-distance relationship? [See William R. Corliss, *Inner Earth* (Glen Arm, Maryland: The Sourcebook Project, 1991), p. 28.]

McDougall did not subject his samples to blind testing, a standard procedure for any critical test in which an investigator’s biases could influence the results, knowingly or unknowingly. While geologists hardly ever consider blind testing, which is intended to ensure accuracy and objectivity, it is standard practice for critical tests within the applied sciences, such as medicine and engineering. (Blind testing is explained on [page 97](#).) Someone should conduct a blind test to check McDougall’s results.

- ◆ *“At the present time insufficient information is available on the ages of volcanoes within these chains to fully test this [hotspot] theory; however, what is known of the ages generally does not support a simple hot spot origin. It has been fairly well established that the age progression associated with hot spot volcanism is not present in either the Line Islands or the Marshall Islands.”* Macdonald et al., *Volcanoes in the Sea*, p. 343.



PREDICTION 13: A well-designed blind test will not support McDougall’s age sequence for seven Hawaiian volcanoes.

- 76. *“It seems that we must abandon the convenient concept of fixed hotspots as reference points for past plate motions.”* Ulrich Christensen, “Fixed Hotspots Gone with the Wind,” *Nature*, Vol. 391, 19 February 1998, p. 740.
- “It was later shown, however, that the Pacific hotspots move relative to those in the Atlantic at rates of 1–2 cm yr⁻¹. This is less than the speed of fast-moving plates (10 cm yr⁻¹), but enough to make the hotspot frame of reference suspect.”* Ibid., p. 739.
- 77. *“The two most difficult observations to explain in terms of hotspots are the lack of subsidence since the cessation of active volcanism 30–25-million years ago and the northeast orientation of the [Bermuda] rise, which is nearly at right angles to the predicted motion of the North American plate.”* Randall M. Richardson, “Bermuda Stretches a Point,” *Nature*, Vol. 350, 25 April 1991, p. 655.
- 78. *“Furthermore, a plate that drifts slowly with respect to the plume source should be more easily penetrated than one that quickly sweeps past it, allowing little time for transfer of heat and melt.”* Marcia McNutt, “Deep Causes of Hotspots,” *Nature*, Vol. 346, 23 August 1990, pp. 701–702.
- 79. Don L. Anderson, “Hotspots, Basalts, and the Evolution of the Mantle,” *Science*, Vol. 213, 3 July 1981, pp. 82–89.
- 80. W. Roger Buck, “A Third Way to Rift Continents,” *Nature*, Vol. 499, 11 July 2013, pp. 157–159.

81. Ibid.
82. *"In nearly all cases, seamount height, and thus seafloor depth, is less than expected of normal seafloor."* Jacqueline Caplan-Auerbach et al., "Origin of Intraplate Volcanoes from Guyot Heights and Oceanic Paleodepth," *Journal of Geophysical Research*, Vol. 105, No. B2, 10 February 2000, p. 2679.
83. In about 1972, I met J. Tuzo Wilson, one of the developers of the plate tectonic theory and the author of the hotspot hypothesis. Wilson stated his belief that plates are driven by drag from a circulating mantle. I explained that plates would move steadily if that were true, not irregularly as happens today. In Iceland, astride the Mid-Atlantic Ridge, such movements could be easily measured with a laser beam and interferometer. Tourists would flock to see an instrument register continuous continental movement before their eyes. Wilson seemed slightly irritated and said, "Everyone talks about making those measurements, but no one does." Wilson then said he had been considering a new mechanism that might move plates. If the Mid-Oceanic Ridge rose, plates would move away from the ridge crest by gravity sliding on a semi-molten mantle. He thought that a few feet of elevation might set plates in motion—very slowly, of course.
- This is similar in several respects to the hydroplate theory: *plates sliding downhill on water, away from the rising Mid-Atlantic Ridge.* However, Wilson's slowly sliding plates would not have the energy or momentum needed to form mountains. [See Endnote 45 on page 213.] His explanation also raises more questions than it answers. Why would the Mid-Atlantic Ridge rise, and why can we not detect it rising today? (Iceland, while seismically active, is not moving apart.) If other portions of the Mid-Oceanic Ridge were rising, their rise would stop continental movement. Wilson was proposing a cause that might produce a known effect, which is legitimate. However, he had no independent evidence of that cause, and his explanation solved no other problems. The hydroplate theory explains past and present plate movements and solves all 25 major mysteries listed on page 111.
84. *"The oceanic crust has been generated almost entirely by outpourings of mafic [basaltic] lavas."* Nicholas M. Short, *Planetary Geology* (Englewood Cliffs, New Jersey: Prentice-Hall, Inc., 1975), p. 98.
- ◆ *"The present ocean basins are characterized by the large-scale outpouring of basalt."* Dickins et al., p. 197.
 - ◆ *"Therefore, all the basalts recovered by DSDP [Deep Sea Drilling Project] in the northwestern Pacific are considered to be sills or lavas that are not necessarily indicative of real oceanic crust. Similar conclusions have also been reached by several authors [references given]."* Choi et al., p. 187.
85. The deepest hole ever drilled into an ocean floor was Hole 504B which reached 2,111 meters (1,311 miles) below the bottom of the eastern Pacific, 250 miles west of Colombia.
- ◆ *"There is a vast need for future Oceanic Drilling Program initiatives to drill below the base of the basaltic ocean floor crust to confirm the real composition of what is currently designated oceanic crust."* Dickins et al., p. 198.
86. Viscosity is a measure of flow resistance. Water has a lower viscosity than syrup. Syrup has a lower viscosity than warm tar. Warm tar has a lower viscosity than cold tar. Air has very low viscosity. Rock, having very high viscosity, will flow only if it is highly compressed in all directions and pressure differences within it are extreme.
87. Silicon, when present, readily bonds with four oxygen atoms, creating silica, a strong tetrahedron (pyramid) with silicon in the center and oxygen atoms at the four vertices. (Sand is basically silica, SiO₂.) These tetrahedra often link together, producing long chains that would look like spaghetti if they could be seen. That "spaghetti" becomes entangled and gives silicon-rich magma its thick, viscous characteristics.
88. Harry Hammond Hess, "Drowned Ancient Islands of the Pacific Basin," *American Journal of Science*, Vol. 244, November 1946, pp. 779–781, 790.
89. Most corals feed on photosynthesizing algae and therefore must live within the top 160 feet of the ocean.
90. Ariel A. Roth, "Coral Reef Growth," *Origins*, Vol. 6, No. 2, 1979, pp. 88–95.
91. Hess, p. 784.
92. *"It is quite common to find groups of guyots [tablemounts] in a relatively small area with flat tops varying several hundred fathoms from one to another among the group."* Hess, p. 777.
93. *"It is rather surprising that the normal guyots are swept clean since water currents at such depths as these are thought to be slight."* Hess, p. 778.
94. J. R. Heirtzler et al., "A Visit to the New England Seamounts," *Earth's History, Structure and Materials*, editor Brian J. Skinner (Los Altos, California: William Kaufmann, Inc., 1980), pp. 153–159.
95. See Endnote 5, page 517.
96. http://en.wikipedia.org/wiki/Andesite_line, last accessed 19 February 2008.
97. Granite, when heated and deformed, can appear to have solidified from a melt, even though it never came from a liquid.
98. J. P. Poirier et al., "Eutectoid Phase Transformation of Olivine and Spinel into Perovskite and Rock Salt Structures," *Nature*, Vol. 321, 5 June 1986, pp. 603–605.
99. Richard G. Gordon and Seth Stein, "Global Tectonics and Space Geodesy," *Science*, Vol. 256, 17 April 1992, pp. 333–341.
100. Bradford Clement et al., "Neotectonics: Watching the Earth Move," *Proceedings of the National Academy of Sciences*, Vol. 96, 7 December 1999, p. 14205.
- ◆ Philip England and Peter Molnar, "Active Deformation of Asia," *Science*, Vol. 278, 24 October 1997, pp. 647–650.
101. Naoki Uchida, et al., "Periodic Slow Slip Triggers Megathrust Zone Earthquakes in Northeastern Japan," *Science*, Vol. 351, 29 January 2016, pp. 488–492.
- ◆ *"The team studied fault movements in the three months before and the nine months after the Magnitude 9.1 Tohoku*

Earthquake that occurred in March 2011 [and killed more than 18,000 people]. *Well before that destructive event, the seafloor slipped in one direction during small quakes. But in the days before the big quake, the direction of slippage reversed.* Phillip Campbell, “Fault Reversal Hints at Coming Quake,” *Nature*, Vol. 557, 10 May 2018, p. 142.

102. “... the deepest quakes should be confined to a thin layer at the center of a descending slab—and the Bolivian quake was just too big [several times too big] to fit.” Richard A. Kerr, “Biggest Deep Quakes May Need Help,” *Science*, Vol. 267, 20 January 1995, pp. 329–330.

◆ “The problem is that large deep earthquakes seem to have occurred on faults larger than expected from the competing [plate tectonic] models of the process causing deep earthquakes.” Seth Stein, “Deep Earthquakes: A Fault Too Big?” *Science*, Vol. 268, 7 April 1995, p. 49.

103. Myron J. Block, “Surface Tension as the Cause of Benard Cells and Surface Deformation in a Liquid Film,” *Nature*, Vol. 178, 22 September 1956, pp. 650–651.

104. Klaus Regenauer-Lieb et al., “The Initiation of Subduction: Criticality by Addition of Water?” *Science*, Vol. 294, 19 October 2001, p. 578.

These authors propose that ocean water may have “softened” the Earth’s crust, breaking it along a narrow band all around the Earth.

Just by adding water, we obtain a narrow faultlike zone for lithosphere separation. ... but a sound quantitative description does not exist. Ibid., p. 580.

◆ “In spite of its importance, it is unclear how subduction is initiated.” Robert J. Stern, “Subduction Initiation: Spontaneous and Induced,” *Earth and Planetary Science Letters*, Vol. 226, 2004, p. 275.

Stern makes two proposals, then says that understanding subduction promises to be an exciting and fruitful area of research.

105. Dapeng Zhao et al., “Depth Extent of the Lau Back-Arc Spreading Center and Its Relation to Subduction Processes,” *Science*, Vol. 278, 10 October 1997, pp. 245–257.

106. Julia Rosen, “Seismic Array Shifts to Alaska,” *Science*, Vol. 358, 6 October 2017, p. 22.

107. http://en.wikipedia.org/wiki/Plate_tectonics

108. N. Christian. Smoot, *Tectonic Globaloney: Closing Arguments* (Bloomington, Indiana: House Press, 2012), pp. 24, 37, 53, 83.

109. H. W. Menard, “The Deep-Ocean Floor,” *Scientific American*, Vol. 221, September 1969, pp. 126–142.

110. “Cloos and Saunders et al. have shown that large oceanic plateaus cannot be subducted. Such thick plateaus resist subduction, jam the trench and accrete to the arc.” Sheth, p. 16.

◆ “It is disturbing that the proposed, exceedingly large differential movements between continents and ocean basins (especially where much unconsolidated sediment is involved) are not obvious. ... The present simple continental-margin model diagrammed with essentially rigid slabs does not relate well to observational data, and its value as a framework for

interpreting observed structures of the continental margin is diminished by the large gap between theory and observation.” Roland von Huene, “Structure of the Continental Margin and Tectonism at the Eastern Aleutian Trench,” *Geological Society of America Bulletin*, Vol. 83, December 1972, p. 3625.

◆ “... slippage of the oceanic crust beneath an overlying trench fill is unsupported by observational as well as theoretical data ...” D. W. Scholl, “Peru-Chile Trench Sediments and Sea-Floor Spreading,” *Geological Society of America Bulletin*, Vol. 81, 1970, pp. 1339–1360.

◆ A. A. Meyerhoff and Howard A. Meyerhoff, “The New Global Tectonics: Major Inconsistencies,” *The American Association of Petroleum Geologists Bulletin*, Vol. 56, February 1972, pp. 269–336.

◆ Warren Hamilton, *Tectonics of the Indonesian Region*, Geological Survey Professional Paper 1078 (Washington, D.C.: U.S. Government Printing Office, 1979), pp. 305–306.

◆ V. Ye. Khain, “Plate Tectonics: Achievements and Unsolved Problems,” *International Geology Review*, Vol. 27, January 1985, p. 5.

111. Fisher and Revelle, p. 15.

112. “[Various groups have attempted to produce a geodynamo], but they haven’t managed to generate self-sustaining dynamos.” Susan Young, “Dynamo Maker Ready to Roll,” *Nature*, Vol. 480, 8 December 2011, p. 163.

◆ “Given the role the planet’s magnetic field plays in guiding navigators and protecting Earth from solar storms, scientists know surprisingly little about it. Geophysicists don’t know exactly how the magnetic field got started billions of years ago or how it has managed to sustain itself for so long. It is even a mystery why Earth has a magnetic field in the first place.” Alexandra Witze, “Spinning the Core,” *Science News*, Vol. 183, p. 28.

After describing experiments that have tried to produce Earth’s magnetic field by a geodynamo, the author above simply states, “No dynamo yet ...” Ibid.

113. A. V. Chekunov et al., “Difficulties of Plate Tectonics and Possible Alternative Mechanisms,” *Critical Aspects of the Plate Tectonics Theory*, Vol. II, editor A. Barto-Kyriakidis (Athens, Greece: Theophrastus Publishing & Proprietary Co., 1990), pp. 397–433.

114. In 1986, Robert S. Dietz, one of the developers of the plate tectonic theory, privately explained this problem to me. With a smile, he declined my suggestion that he publish that fact.

115. “But between 28° and 33°S the subducted Nazca plate appears to be anomalously buoyant, as it levels out at about 100 km depth and extends nearly horizontally under the continent.” John R. Booker et al., “Low Electrical Resistivity Associated with Plunging of the Nazca Flat Slab beneath Argentina,” *Nature*, Vol. 429, 27 May 2004, p. 400.

116. Peter Molnar, “Continental Tectonics in the Aftermath of Plate Tectonics,” *Nature*, Vol. 335, 8 September 1988, p. 133.

117. Ibid.

118. Thomas Chrowder Chamberlin, “The Method of Multiple Working Hypotheses,” *Journal of Geology*, Vol. 5, 1897, pp. 837–848. This famous paper was also reprinted in *Journal of Geology*, Vol. 31, 1931, pp. 155–165 and in *A Source Book in Geology: 1400–1900*, editors Kirtley F. Mather and Shirley L. Mason (Cambridge, Massachusetts: Harvard University Press, 1967), pp. 604–630.

119. *“But conventional ideas about how such a dramatic breakup might progress could be wrong. Resent results have spilled unexpected discoveries onto the pages of prominent journals, implying that the rift has diverged from expectations.”* Shannon Hall, “Africa’s Big Breakup,” Vol. 39, May 2018, p. 52.

120. Earth’s pre-flood magnetic field could easily have been less than one hundredth of today’s magnetic field and still have helped shield the Earth from harmful radiation. Here’s why.

Our atmosphere substantially shields Earth’s surface from solar and cosmic rays. At sea level, the atmosphere provides the same shielding as 3 feet of lead. Some of the pre-flood atmosphere was expelled by the fountains of the great deep. Therefore, atmospheric shielding before the flood would have been somewhat greater than today.

Earth’s magnetic field provides some shielding from charged particles, except near the magnetic poles. Although the moon has no atmosphere, astronauts on the moon were shielded from harmful radiation by their space suits and the moon’s weak magnetic field, which is *less than one hundredth that of the Earth*. Astronauts were on the moon in 1969, when solar radiation was at its 11-year solar maximum.

121. Within the inner Earth, high-pressure friction heated the walls of thousands of sliding faults. Minerals in those walls with melting temperatures below those of magnetite melted, freeing the denser magnetite. As magnetite crystals fell toward the center of the Earth, pressures increased, phase changes occurred, and magnetite’s melting temperature increased. Magnetite’s high-pressure phase is stable at pressures of 75 GPa and temperatures of 2,000 K.

A high-pressure phase of magnetite (Fe₃O₄) (orthorhombic) and iron hydride (double hcp) were found to exist stably under these conditions.

[See Surendra Saxena et al., “Formation of Iron Hydride and High-Magnetite at High Pressure and Temperature,” *Physics of the Earth and Planetary Interiors*, Vol. 146, August 2004, p. 313.]

Saxena et al. observed a high-pressure phase of magnetite forming as follows:

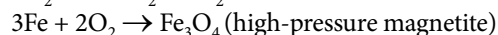
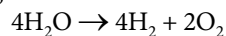

In their experiments, heating the hydrated mineral (brucite) released the water on the left side of the first equation.

Water molecules locked in mantle minerals were probably released in a similar way as the inner Earth melted. [See “**Water in the Upper Mantle**” on page 167.] Oxygen then combined with iron at high pressure and temperature to produce huge amounts of magnetite with high melting

temperatures. The magnetite then settled onto the inner core to form Earth’s gigantic magnetic field.

122. On 22 April 2007, Rod Nance, an electrical engineer, suggested to me that Earth’s magnetic field somehow originates in the inner core, not the outer core, as I and most others had commonly believed. Nance was familiar with the problems associated with the view that a dynamo, operating in the outer core, produced Earth’s magnetic field. Evolutionists have tried in vain to patch up those problems for decades. Once my focus shifted from the outer core to the inner core, I saw how gravitational settling resulting from the melting of the inner Earth produced Earth’s magnetic field. [See “**Melting the Inner Earth**” on page 603.]

123. Recall in our explanation of the Earth’s roll (Endnote 84, page 148) that during the Earth roll, the inner core rolled wildly, because its moment of inertia was more than a thousand times less than that of the slowly rolling and precessing outer Earth and the total angular momentum of the Earth had to be conserved. Therefore, as magnetic crystals settled onto and aligned with the magnetic field of the tumbling inner core, they formed sedimentary layers with crystal orientations that were not parallel with adjacent layers. These strangely oriented layers within the inner core have recently been discovered by seismic techniques.

In 2002, scientists discovered that the 2,440-kilometer wide inner core had layers of its own. The orientation of the iron in the core depends on what conditions were like when the iron solidified. Scientists can measure that orientation by seeing how quickly earthquake waves move at different angles: They move faster when they’re aligned with the iron’s orientation. Earthquake waves revealed that the center of the inner core, a region about 1,200 kilometers across, has a different orientation compared with that of the rest of the inner core. The cause of this off-kilter core became an unsolved mystery in the geophysics community. Thomas Sumner, “Earlier Origin for Earth’s Center,” *Science News*, Vol. 189, 23 January 2016, p. 8.

124. *“... the cycle is remarkably regular, with the maximum change in day length occurring once every 5.9 years.”* Cristy Gelling, “Day Length Changes Every Six Years,” *Science News*, Vol. 184, 24 August 2013, p. 11.

125. *“... jerks might, for example, not be observed in Europe, but instead be observed in the region antipodal to Europe.”* Jeremy Bloxham et al., “The Origin of Geomagnetic Jerks,” *Nature*, Vol. 420, 7 November 2002, p. 67.

126. “[There is] *a striking correspondence between the occurrence of strong earthquakes and the magnetic field singularities.*” Fabio Florindo and Laura Alfonsi, “Strong Earthquakes and Geomagnetic Jerks: A Cause-Effect Relationship?” *Annali di Geofisica*, Vol. 38, September-October 1995, p. 457.

◆ Fabio Florindo et al., “Could the Mw=9.3 Sumatra Earthquake Trigger a Geomagnetic Jerk?” *Eos, Transactions American Geophysical Union*, Vol. 86, 22 March 2005, p. 123.

127. R. Holme and O. de Viron, "Characterization and Implications of Intradecadal Variations in Length of Day," *Nature*, Vol. 499, 11 July 2013, pp. 202–204.
- ◆ "But no one knows what causes geomagnetic jerks. I have no clue," said Holme." <http://www.livescience.com/38083-earth-core-day-length-pattern.html>
128. One geomagnetic jerk in 1969–1970, was accompanied by a sudden shifting ahead of the inner core's rotation by 50 degrees. This shift was discovered in 1971 by Professor Adam Dziewonski of Harvard University and his research associate Wei-jia Su.
- The coincidence in time between the geomagnetic jerk of 1969–1970 and the rapid change in the inner core orientation [was 50 degrees].* Wei-jia Su, et al., "Planet Within a Planet: Rotation of the Inner Core of Earth," *Science*, Vol. 274, 13 December 1996, p. 1886.
- ◆ "Around 1971, the axis of anisotropy, and presumably the inner core, shifted ahead some 50 degrees. ... At nearly the same time, the magnetic field at the surface [of the Earth] underwent an abrupt change known as a 'magnetic jerk.'" William J. Cromie, "Putting a New Spin on Earth's Core," *The Harvard University Gazette*, 15 August 1996.
129. "Any successful account of geomagnetism must explain what caused the pole reversals at various times in history. ... No one has developed an explanation of why the sign reversals take place. The apparently random reversals of the Earth's dipolar field have remained inscrutable." Charles R. Carrigan and David Gubbins, "The Source of the Earth's Magnetic Field," *Scientific American*, Vol. 240, February 1979, p. 125.
130. "New calculations show that the electrical resistance of Earth's liquid-iron core is lower than had been thought. The results prompt a reassessment of how the planet's magnetic field has been generated and maintained over time. ... the thermal conductivity of liquid iron under the conditions in Earth's core is several times higher than previous estimates. ... Such large thermal conductivities allow a substantial amount of heat to be carried by conduction, leaving less heat to drive convection. Convection may even cease in parts of the core. ... the properties of liquid iron make the operation of magnetic dynamos in terrestrial planets even more precarious than was previously believed. We are left with the challenge of understanding how Earth has succeeded in maintaining its magnetic field over most of geological time." Bruce Buffett, "Geomagnetism under Scrutiny," *Nature*, Vol. 485, 17 May 2012, pp. 319–320.
- ◆ "But here is the fundamental problem with our understanding of the geodynamo: It can't work in the way geophysicists have long believed." Tim Folger, "Journeys to the Center of the Earth," *Discover*, July/August 2014, p. 40.
131. At the Earth's surface, relative motion is seen on opposite sides of faults. Therefore, some lubricant must be present somewhere below to allow slippage. The founders of the plate tectonic theory assumed that the crust slipped relative to the mantle, but at the same time, they knew that the crust today should be frictionally locked to the mantle.
- Almost since plate tectonics was discovered, there has been debate over the nature of the uppermost asthenosphere, particularly whether a lubricating mechanism is required to weaken it and facilitate plate motion. ... some mechanism that lowers the viscosity of a boundary layer beneath the plates is indeed necessary.* Rob L. Evans, "Making the Earth Move," *Nature*, Vol. 509, 1 May 2014, p. 40.
- The search continues to find some mechanism, but students (and their teachers) are not told about this problem. As you will see, the slippage occurs in the liquid outer core.
132. Tremors are concentrated in areas where the fault slips most rapidly. [See Witze, p. 28.] Therefore, I believe tremors are probably caused by *stiction*, a term derived from the words "static friction." Consider two mantle blocks pressing against each other on either side of a vertical fault. A greater force is required to initiate horizontal sliding (to overcome static friction) than to maintain sliding once movement has begun. If the pressing force is great, as it would be deep in the mantle, sliding will stop and start many times per second, creating a low-frequency tremor.



Figure 101: Floating Tank. During a 1964 earthquake in Niigata (NEE-gat-ah), Japan, the ground turned to a dense liquidlike substance, causing this empty concrete tank to float up from just below ground level. This was the first time geologists identified the phenomenon of *liquefaction*, which had undoubtedly occurred in other large earthquakes. Liquefaction has even lifted empty tanks up through asphalt pavement¹ and raised pipelines and logs out of the ground.² In other words, buried objects less dense than surrounding soil rise buoyantly when that soil liquefies. **What causes liquefaction? What would happen to buried animals and plants in temporarily liquefied sediments?**



Figure 102: Sinking Buildings. During the above earthquake, building number 3 sank and tipped 22 degrees as the ground partially liquefied. Another building, seen at the red arrow, tipped almost 70 degrees, making its roof nearly vertical.

Liquefaction: The Origin of Strata and Layered Fossils

SUMMARY: *Liquefaction—associated with quicksand, earthquakes, and wave action—played a major role in rapidly sorting sediments, plants, and animals during the flood. Indeed, the worldwide presence of sorted fossils and sedimentary layers shows that a gigantic global flood occurred. Massive liquefaction also left other diagnostic features, such as cross-bedded sandstone, plumes, mounds, and fossilized footprints.*

Sedimentary rocks are distinguished by sharply-defined layers, called **strata**. Fossils almost always lie within such layers. Fossils and strata, seen globally, have many unusual characteristics. A little-known phenomenon called **liquefaction** (lik-wuh-FAK-shun) explains these characteristics. It also explains why we do not see fossils and strata forming on a large scale today.

We will first consider several common situations that cause liquefaction on a small scale. After understanding why liquefaction occurs, we will see that a global flood would produce liquefaction—and these vast, sharply defined layers—worldwide. Finally, a review of other unusual features in the Earth’s crust will confirm that global liquefaction did occur.

Examples of Liquefaction

Quicksand. Quicksand is a simple example of liquefaction. Spring-fed water flowing up through sand creates quicksand. The upward flowing water lifts the sand grains very slightly, surrounding each grain with a thin film of water. This cushioning gives quicksand, and other liquefied sediments, a mushy, fluidlike texture.³

Contrary to popular belief and Hollywood films, a person or animal stepping into deep quicksand will not sink out of sight forever. They will quickly sink in—but only so far.

Then, they will be lifted, or buoyed up, by a force equal to the weight of the sand and water displaced. The more they sink in, the greater the lifting force. Buoyancy forces also lift a person floating in a swimming pool. However, quicksand’s buoyancy is almost twice that of water, because the weight of the displaced sand and water is almost twice that of water alone. As we will see, fluidlike sediments produced a buoyancy that largely explains why fossils show a degree of vertical sorting and why the world’s sedimentary rocks are usually layered sharply.

Earthquakes. Liquefaction is frequently seen during, and even minutes after, earthquakes. During the Alaskan Good Friday earthquake of 1964, liquefaction caused most of the destruction within Anchorage, Alaska. Much of the damage during the San Francisco earthquake of 1989 resulted from liquefaction. Although geologists can describe the consequences of liquefaction, few seem to understand why it happens. Levin describes it as follows:

Often during earthquakes, fine-grained water-saturated sediments may lose their former strength and form into a thick mobile mudlike material. The process is called liquefaction. The liquefied sediment not only moves about beneath the surface but may also rise through fissures and “erupt” as mud boils and mud “volcanoes.”⁴

Liquefaction was captured on film after the 9.0 Japanese earthquake on 11 March 2011. In a city park built over a landfill in what was part of Tokyo Bay, subsurface water that had been trapped in the sediment’s pore spaces is seen erupting through cracks produced by the swelling of the land. [See www.youtube.com/watch?v=I3hJK1BoRak, and www.youtube.com/watch?v=9x_kS3Bm6fA&feature=related.]

Strahler says that in a severe earthquake:

... the ground shaking reduces the strength of earth material on which heavy structures rest. Parts of many

major cities, particularly port cities, have been built on naturally occurring bodies of soft, unconsolidated clay-rich sediment (such as the delta deposits of a river) or on filled areas in which large amounts of loose earth materials have been dumped to build up the land level. These water-saturated deposits often experience a change in property known as liquefaction when shaken by an earthquake. The material loses strength to the degree that it becomes a highly fluid mud, incapable of supporting buildings, which show severe tilting or collapse.⁵

These are accurate descriptions of liquefaction, but they do not explain why it occurs. When we understand the mechanics of liquefaction, we will see that liquefaction occurred globally—for weeks or months during the flood.

Visualize a box filled with many rocks. If the box were so full that you could not quite close its lid, you would shake the box, so the rocks settled into a denser packing arrangement. Now repeat this thought experiment, only this time all space between the rocks is filled with water. As you shake the box and the rocks settle into a denser packing arrangement, water will be forced up to the top by the “falling” rocks. If the box is tall, many rocks will settle, so the force of the rising water will increase. The tall column of rocks will also provide great resistance to the upward flow, increasing the water’s pressure even more. Water pressure will exert a lifting force on the rocks for as long as the upward flow continues.⁶

This is similar to an earthquake in a region having loose, water-saturated sediments. Once upward-flowing water lifts the topmost sediments, weight is removed from the sediments below. The upward flow can then lift the second level of sediments. This, in turn, unburdens the particles beneath them, etc. The particles are no longer in solid-to-solid contact, but are suspended in and lubricated by water, so they can easily slip by each other.

Wave-Loading—A Small Example. You are barefoot, walking along the beach. As each wave comes in, water rises from the bottom of your feet to your knees. When the wave returns to the sea, the sand beneath your feet becomes loose and mushy. As your feet sink in, walking becomes difficult. This temporarily mushy sand, familiar to most of us, is a small example of liquefaction.

Why does this happen? Below each wave crest, water is forced down into the sand. As the wave trough approaches, that water gushes back out. In doing so, it lifts the topmost sand particles, forming the mushy mixture.

If you submerged yourself face down under breaking waves but just above the seafloor, you would see sand particles rise slightly above the floor as each wave trough approached. Water just above the sand floor also moves

back and forth horizontally with each wave cycle. Fortunately, the current moves toward the beach as liquefaction lifts sand particles above the floor. So, sand particles are continually nudged upslope, toward the beach. If this did not happen, beaches would not be sandy.⁷

Wave-Loading—Medium-Sized Example. During a storm, as large waves pass over pipes buried offshore, water pressure increases below the wave crests. This forces more water into the porous sediments surrounding the pipes. As the wave peaks pass and the wave troughs approach, pressure over the pipes drops, and the stored, high-pressure water in the sediments flows upward. This lifts the sediments and causes liquefaction. The buried pipes, “floating” upward, sometimes break.⁸

Wave-Loading—A Large Example. On 18 November 1929, an earthquake struck the continental slope off the coast of Newfoundland. Minutes later, transatlantic phone cables began breaking sequentially, farther and farther downslope, away from the epicenter. Twelve cables were snapped in a total of 28 places. Exact times and locations were recorded for each break. Investigators suggested that a 60-mile-per-hour current of muddy water swept 400 miles down the continental slope from the earthquake’s epicenter, snapping the cables.⁹

This event intrigued geologists. If thick muddy flows could travel that fast and far, they could erode long submarine canyons and do other geological work. Such hypothetical flows, called *turbidity currents*, now constitute a large field of study within geology. However, there are several problems with this 60-mile-per-hour, turbidity-current explanation:

- ◆ water resistance prevents even conventional nuclear-powered submarines from traveling nearly that fast,
- ◆ the ocean floor in that area off the coast of Newfoundland slopes less than 2 degrees,¹⁰
- ◆ some broken cables were upslope from the earthquake’s epicenter, and
- ◆ nothing approaching a 400-mile-long landslide has ever been observed—let alone underwater, on only a 2-degree slope.

Instead, a large wave (a tsunami¹¹) probably radiated out rapidly from the earthquake’s epicenter. Below the expanding wave, sediments on the seafloor partially liquefied. Then, they slowly flowed downhill¹² where they loaded and snapped cable segments that were perpendicular to the downhill flow. Other details support this explanation.

We can now see that **liquefaction occurs whenever water is forced up through loose sediments with enough pressure to lift the topmost sedimentary particles.** Now let’s look at a gigantic example of liquefaction, caused by many weeks of global wave-loading.

Water Hammers and Flutter Produced Gigantic Waves

Water Hammers. Water hammers occur, usually with a loud bang, when water (or any liquid or gas) flowing in a pipe is suddenly stopped or slowed by closing (or narrowing) a valve, such as a faucet. A water hammer is similar to the collision of a long train. The faster and more massive the flowing volume of water, the greater the sudden compression (or pressure pulse) throughout the pipe as the water is slowed or stopped. A water hammer concentrates energy, just as a hammer striking a nail concentrates energy and produces forces many times greater than a resting hammer.

Flutter. Vibrations often begin when a fluid (a liquid or gas) flows along a relatively thin, flexible surface, such as the wing of an airplane, a reed in a musical instrument, or a flat plate. If (a) the flowing fluid continually “thumps” or pushes the vibrating surface back toward its neutral position, and (b) the “thumping” frequency approaches any natural frequency of the flexible surface, large, damaging, oscillations (or resonances), called *flutter*, can occur.

Both the large area of the Earth’s crust (200,000,000 square miles) and its “squishy,” supercritical-water (SCW) foundation gave the crust great flexibility. Therefore, flutter quickly began as water was escaping beneath Earth’s crust during the flood. Each narrowing of the subsurface flow channel by the vibrating crust slowed trillions of tons of water and produced water hammers that “thumped” the crust at *each* of its natural frequencies. Undulations rippled throughout the crust, causing other water hammers, more undulations, large flutter amplitudes, and pulsations in the fountains. Most people have heard water pipes banging or have seen pipes burst when only a few cubic feet of water were slowed. Imagine the excruciating pressures from rapidly slowing a “moving underground ocean.”¹³

The escaping subterranean water produced another chain reaction. Pillars (explained in [Figure 55 on page 124](#)) had to carry more and more of the crust’s weight, because the diminishing subterranean water carried less. Therefore, pillars nearest the rupture collapsed first—but in stages. Then, adjacent pillars, suddenly supporting additional loads, also began collapsing in stages, as a falling house of cards, creating more vibrations. The crust vibrated in complex, wavelike patterns, like a fluttering flag held horizontally in a strong wind. Vibrations closed “valves” which, in turn, created water hammers, which created more vibrations. Amplitudes grew, and waves rippled around the Earth.

Forces familiar to us will not compress water much. However, the weight of 60 miles of rock will compress *liquid water* by about 34%.¹⁴ Because the SCW trapped below the massive, vibrating crust was primarily a gas, **SCW was more than a thousand times more compressible (or “springy”) than liquid water.** The SCW acted as trillions of long, soft springs supporting a massive (high inertia) crust. That combination—a large mass vibrating on a very compressible spring—produced huge amplitudes and long vibrational periods, about 30 minutes in length. [See [“Frequency of the Fluttering Crust” on page 606.](#)]

Understanding flutter will become extremely important when we get to the [“The Origin of Earth’s Radioactivity” on pages 379–433.](#) [For example, see [Figure 210 on page 391.](#)] That chapter will explain basic errors in radiometric dating, the staggering energy and power of the fountains of the great deep, and why flutter amplitudes were even greater than is now apparent—large enough to cyclically lift the top of the fluttering crust out of the flood waters.

Liquefaction During the Flood

The flooded Earth had enormous, unimpeded waves—not normal waves, but waves on top of and generated by fluttering hydroplates. With each flutter cycle, high water was forced down into and up out of the accumulating sediments on the seafloor. Under a wave peak, water was forced, not only down into the sediments below, but laterally through the sediments, toward pressure minimums that were simultaneously occurring one-half wavelength away, under wave troughs. Later, when a wave trough arrived, the flows reversed, and water flowed upward. Water almost completely surrounded each sediment particle deposited on the ocean floor during the flood, giving each particle maximum buoyancy. Therefore, the sediments were loosely packed and held much water.

Half the time during the flood phase, water was pushed down into the sediments, stored for the other (discharge) half-cycle in which water flowed upward. During discharge, liquefaction occurred if the water’s upward velocity exceeded a specific minimum. When it did, interesting things happened.

A thick, horizontal layer of sediments provides high resistance to upward flowing water, because the water must flow through tiny, twisting channels between particles. Great pressure is needed to force water up through such layers. During liquefaction, falling sediments and high waves provide this high pressure.

If water flows up through a bed of sediments with enough velocity, water pressure will lift and support each sedimentary particle. Instead of thinking of water flowing up through the sediments, think of the sediments falling



Figure 103: Liquefaction Demonstration. When the wooden blocks at the top of the horizontal beam are removed, the beam can rock like a teeter-totter. As the far end of the beam is tipped up, water flows from the far tank down through the pipe and up into the near tank, which holds a mixture of sediments. Once liquefaction begins, the sediments become mushy, their volume swells slightly, sedimentary particles fall or rise relative to each other, sorting themselves into layers, each having particles with similar size, shape, color and density. Buried objects with the density of plants and dead animals float up through the mushy sediments—*until they reach a liquefaction lens*. The same would happen to plants and animals buried during the flood.

Their sorting and later fossilization might give the mistaken impression that organisms buried and fossilized in higher layers evolved millions of years after lower organisms. A school of thought, with appealing philosophical implications for some, would arise that claimed changes in living things were simply a matter of time. With so many complex differences among protons, peanuts, parrots, and people, eons of time must have elapsed. With so much time available, many other strange observations might be explained. Some would try to explain even the origin of the universe, including space, time, and matter, using this faulty, unscientific school of thought. Of course, these ideas could not be demonstrated, as liquefaction can be, because too much time would be needed.

down through a very long column of water. Slight differences in density, size, or shape of adjacent particles will cause them to fall at slightly different speeds. Their relative positions will change until the water's velocity drops below a certain value or until nearly identical particles are adjacent to each other, so they fall at the same speed. This sorting produces the sharply-defined layering seen in sedimentary rocks worldwide. As you will see, these vast, sharply-defined sedimentary layers are unmistakable characteristics of liquefaction and a global flood.

Such sorting also explains why sudden local floods sometimes produce horizontal strata on a small scale.¹⁵ Liquefaction can occur as mud settles through water or as water is forced up through mud.

To understand liquefaction better, I built the simple apparatus shown in [Figure 103](#). The 10-foot-long metal beam pivoted like a teeter-totter from the top of the 4-legged stand. Suspended from each end of the beam was a 5-gallon container, one containing water and one containing a mixture of different sediments. A 10-foot-long pipe connected the mouths of the two containers.

Gently tipping the metal beam raised the water tank. Water flowed down through the pipe and up through the bed of mixed sediments in the other tank. If the flow velocity exceeded a very low threshold,¹⁶ the sediments swelled slightly as liquefaction began. Buried objects with

the density of a dead animal or plant floated to the top of the tank. Once water started to overflow the sediment tank, the metal beam had to be tipped, so the water flowed back into the water tank. After repeating this cycle for 10 or 15 minutes, the mixture of sediments became visibly layered. The more cycles, the sharper the boundaries between sedimentary layers.

Liquefaction (Water) Lenses

An important phenomenon, which will be called *lensing*, was observed in the sediment tank. Some layers were more porous and permeable than others. If water flowed more easily up through one sedimentary layer than the layer directly above, a lens of water accumulated between them. Multiple lenses could form simultaneously, one a short distance above the other. Water in these nearly horizontal lenses always flowed uphill.¹⁷

Throughout the flood, countless water lenses grew and then decreased with each wave cycle. [See [Figure 104](#).] During liquefaction, organisms floated up into the lens directly above. Water's buoyant force is only about half that of liquefied sediments, so a water lens was less able to lift dead organisms into the denser sedimentary layer directly above the lens. In each geographical region, organisms with similar size, shape, and density (usually members of the same species) often ended up in the same

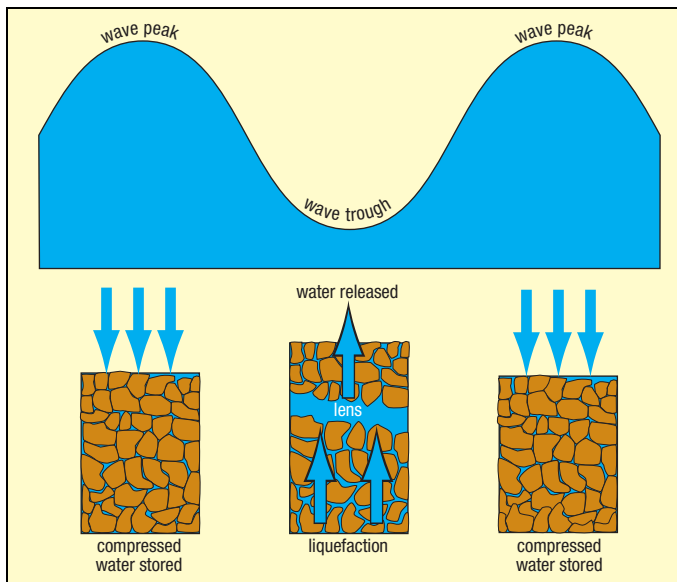

Figure 104: Liquefaction and Water Lenses. The wave cycle begins at the left with water being forced down into the seafloor. As the wave trough approaches, that compressed water is released. Water then flows up through the seafloor, lifting the sediments, starting at the top of the sedimentary column. During liquefaction, denser particles sink and lighter particles (and dead organisms, soon to become fossils) float up—**until a liquefaction lens is encountered**. Lenses of water form along nearly horizontal paths if the sediments below those horizontal paths are more permeable than those above, so more water flows up into each lens than out through its roof. Sedimentary particles and dead organisms buried in the sediments were sorted and resorted into vast, thin layers.

In an unpublished experiment at Loma Linda University, a dead bird, mammal, reptile, and amphibian were placed in an open water tank. Their buoyancy in the days following death depended on their density while living, the buildup and leakage of gases from their decaying bodies, the absorption or loss of water by their bodies, and other factors. That experiment showed that the natural order of settling following death was, from the bottom up: amphibian, reptile, mammal, and finally bird.¹⁸ **This order of relative buoyancy correlates closely with “the evolutionary order,” but, of course, evolution was not the cause.** Other factors influencing burial order at each geographical location were: liquefaction lenses, which animals were living in the same region, each animal’s mobility before the flood overtook it, and the animal or plant’s shape (how much fluid drag from the upward flowing water lifted the organism).

lens. There, they were swept by currents for many miles along those nearly horizontal channels.¹⁹

Coal. Vegetation lifted by liquefaction into a water lens spread out and formed a buoyant mat pressed up against the lens’ roof. Vegetation mats, composed of thin, flat, relatively impermeable sheets, such as intertwined leaves, ferns, grass, and wood fragments, could not push through that roof. These mats also prevented sedimentary grains in the roof from falling to the floor of the lens.

Each vegetation mat acted as a *check valve*; that is, during the portion of the wave cycle when water flowed upward, the mat reduced the flow upward through the lens’ roof,

so the lens’ volume grew. During the other half of the wave cycle, when water flowed downward, the mat was pushed away from the roof allowing new water to enter the lens. Therefore, water lenses with vegetation mats thickened and expanded during the flood. *Vegetation mats became today’s coal seams, some of which can be traced over 100,000 square miles.*

Cyclothems. Sometimes, fifty or more coal seams are stacked one above the other with a special sequence of sedimentary layers separating the coal layers. A typical sequence between coal seams (from bottom to top) is sandstone, shale, limestone, and finally denser clay graded up to finer clay. These cyclic patterns, called *cyclothems*, are in the order one would expect from liquefaction: denser, rounder, larger sedimentary particles at the bottom and less dense, flatter, finer sedimentary particles at the top. Cyclothem layers worldwide generally have the same relative order, although specific layers may be absent.

Fossils. When a liquefaction lens slowly collapsed for the last time, plants and small animals were trapped, flattened, and preserved between the lens’ roof and floor. Fossils, sandwiched between thin layers, were often spread over a wide surface, which geologists call a **horizon**. Thousands of years later, these horizons gave some investigators the false impression that those animals and plants died long after layers below were deposited and long before layers above were deposited. A layer with many fossils covering a vast area was misinterpreted as an extinction event or a boundary between geologic periods.

Early geologists noticed that similar fossils were often in two closely spaced horizontal layers. It seemed obvious that the subtle differences between each layer’s fossils must have developed during the assumed long time interval between the deposition of each layer. Different species names were given to these organisms, although nothing was known about their inability to interbreed—the true criterion for identifying species. Later, in 1859, Charles Darwin claimed that a previously recognized mechanism, *natural selection*,²⁰ accounted for the evolution of those subtle differences. **However, if liquefaction simply sorted organisms based on their already existing natural variations, Darwin’s explanation is irrelevant.**

Two Faulty “Principles.” Early geologists learned that fossils found above or below another type of fossil in one location were almost always in that same relative position, even many miles away. This led to a belief that the lower organisms lived, died, and were buried before the upper organisms. Much time supposedly elapsed between the two burials, because sediments—at least today—are usually deposited very slowly. Each horizon became associated with a specific time, perhaps millions of years earlier (or later) than the horizon above (or below). Finding so many examples of “the proper sequence” convinced early

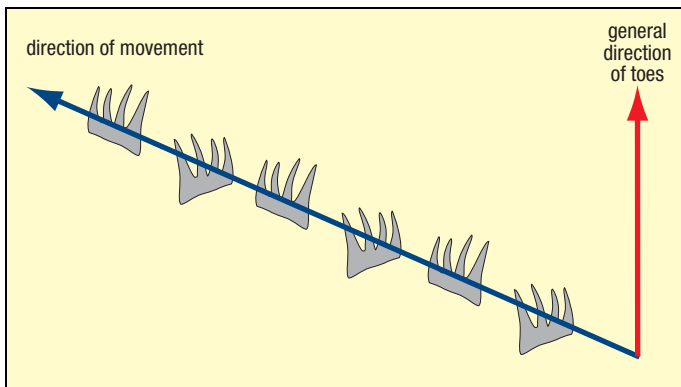

Figure 105: Drifting Footprints. Hundreds of footprints, along 44 different trackways, were discovered in cross-bedded sandstone layers of northern Arizona. Surprisingly, movement was in one direction, but the toes pointed in another direction—sometimes at almost right angles. This shows that the animals, probably amphibians, encountered some type of lateral flow while walking on sand.²¹ It also contradicts the standard story that cross-bedded sandstone layers were once ancient sand dunes. Almost all trackways moved uphill, and traces of the animal’s bodies are never found, even as fossils. Obviously, thick sediments must have *gently and quickly* blanketed the footprints to prevent their erosion—but how? Evolutionists have difficulty explaining what protected these delicate footprints.

How did it happen? During the early weeks of the flood, flutter amplitudes were large enough for the crust to rise repeatedly, but slowly, out of the flood waters. [See “**Water Hammers and Flutter Produced Gigantic Waves**” on page 197.] Frightened animals—and sometimes dinosaurs—scampered uphill onto the rising land, each leaving footprints. Minutes later, the crust again submerged, allowing sediments falling through the thick muddy waters to blanket and protect the prints while the rising water swept the animals’ bodies away. Other perishable prints—called *trace fossils*—were made in the same way. [See item 9 on page 201.]

Each time the fluttering crust rose above the muddy flood waters, it had (in evolutionary terms) “thousands of years” worth of additional layered sediments containing sorted dead things trapped in liquefaction lenses. The approximate order of burial, from the bottom up, was sea-bottom creatures, then animals and plants that were first overcome, ripped up, and deposited by the initial flood waters, followed by the larger animals that could float and live for a time (such as many dinosaurs), and finally mobile animals that could flee to high ground. Each region had its own mix of animals and plants. Once they were buried in sediments, liquefaction provided additional sorting by such characteristics as density and shape. Sometimes, dinosaur prints from the previous upward flutter minutes earlier were sandwiched between layers that never experienced liquefaction again.

geologists they had found a new principle of interpretation, which they soon called *the principle of superposition*.

Evolutionary geology is built upon this and one other “principle,” *the principle of uniformitarianism*, which states that all geological features can be explained by today’s processes acting at present rates.²² For example, today, rivers deposit sediments at river deltas. Over millions of years, thick layers of sediments would accumulate. This might explain the sedimentary rocks we now see.

After considering liquefaction, the flaws in both “principles” become obvious. Sediments were sorted and

deposited throughout a tall liquefaction column almost simultaneously by a large-scale process not occurring today. (These “principles” are really assumptions. Calling them “principles” gives them undeserved credibility.)

Testing the Theories

How can we compare and test the two conflicting explanations: liquefaction versus uniformitarianism and the principle of superposition over billions of years?

1. Sedimentary layers often span hundreds of thousands of square miles. (River deltas, where sediment thicknesses grow most rapidly today, are a tiny fraction of that area.) Liquefaction during a global flood would account for the vast expanse of these thick layers. Current processes and eons of time do not.
2. One thick, extensive sedimentary layer has remarkable purity. The St. Peter sandstone, spanning about 300,000 square miles in the central United States, is composed of almost pure quartz, similar to sand on a white beach. It is hard to imagine how any geologic process, other than global liquefaction, could achieve this degree of purity over such a wide area.²³ Most processes involve mixing, which destroys purity.
3. Today, sediments are usually deposited in and by rivers—along a narrow line. However, individual sedimentary rock layers are spread over large geographical areas, not on long narrow, streamlike paths. Liquefaction during the flood acted on all sediments and sorted them over wide areas in weeks or months.
4. Sedimentary layers are usually thin, sharply defined, parallel, and horizontal. They are often stacked vertically for thousands of feet. If layers had been laid down thousands of years apart, surface erosion would have destroyed this parallelism. Liquefaction, *especially liquefaction lenses*, explain these sharp boundaries.
5. Sometimes adjacent, parallel layers contain such different fossils that evolutionists conclude that those layers were deposited millions of years apart, but the lack of erosion shows that the layers were deposited rapidly. Liquefaction resolves this paradox.
6. Many communities around the world get their water from deep, permeable, water-filled, sedimentary layers called *aquifers*. When water drains from an aquifer, the layer collapses, unable to support the overlying rock layers. Collapsed aquifers cannot be replenished, so how were aquifers originally filled?

Almost all sorted sediments were deposited within water, so aquifers contained water when they first formed. Today, aquifers are collapsing at an alarming rate globally,²⁴ so they could not have formed millions

The Mining Industry Rediscovered Liquefaction²⁵

The mining industry frequently uses a technique called *jigging* to extract valuable minerals from ores, sediments, or crushed rock. Jigging will remind you of liquefaction during the global flood, except that during the flood, the sorting forces were thousands of times greater and they acted on thousands of feet of sediments over the entire Earth by wave loading. With jigging, cyclic water pulses in massive machines briefly lift sedimentary particles. The particles then settle and increasingly stratify by density and size. An animation of this technique can be seen at www.youtube.com/watch?v=RDgZtTEhMVk

of years ago. Instead, liquefaction sorted sediments and created aquifers relatively recently, during the flood.

7. Varves are extremely thin layers (typically 0.004 inch or 0.1 mm), which evolutionists claim are laid down *annually* in lakes. By counting varves, evolutionists believe that time can be measured. The Green River Formation of Wyoming, Colorado, and Utah, a classic varve region, contains billions of flattened, paper-thin, fossilized fish; thousands were buried and fossilized in the act of swallowing other fish. [See [Figure 10 on page 10](#).] Obviously, burial was sudden. Fish, lying on the bottom of a lake for years, would decay or disintegrate long before enough varves could bury them. (Besides, dead fish typically float, deteriorate, and then sink.) Most fish fossilized in varves show exquisite detail and are pressed to the thinness of a piece of paper, as if they had been compressed in a collapsing liquefaction lens.

Also, varves are too uniform, show almost no erosion, and are deposited over wider areas than where streams enter lakes—where most lake deposits occur. Liquefaction best explains these varves.



PREDICTION 14: Corings taken anywhere in the bottom of any large lake will not show laminations as thin, parallel, and extensive as the varves of the 42,000-square-mile Green River Formation, probably the world's best-known varve region.

8. In almost all cases, dead animals and plants quickly decay, are eaten, or are destroyed by the elements. Preservation as fossils requires rapid burial in sediments thick enough to preserve bodily forms. This rarely happens today. When it does, as in an avalanche or a volcanic eruption, the blanketing layers are not uniform in thickness, do not span tens of thousands of square miles, and rarely are water-deposited. (Water is needed if cementing is to occur.) Liquefaction provides a mechanism for rapid, but gentle, burial and preservation of trillions of

delicate fossils in water-saturated sedimentary layers. [See also "[Rapid Burial](#)" on [page 11](#).]

Thousands of fossilized jellyfish have been found in central Wisconsin, sorted to some degree by size into at least seven layers (spanning 10 vertical feet) of coarse-grained sediments.²⁶ Evolutionists admit that a fossilized jellyfish is exceedingly rare, so finding thousands of them in what was coarse, abrasive sand is almost unbelievable. Claiming that it occurred during storms at the same location on seven different occasions, but over a million years, is ridiculous.

What happened? Multiple liquefaction lenses, vertically aligned during the last liquefaction cycle, trapped delicate animals, such as jellyfish, and preserved them, as the roof of each water lens gently settled onto its floor.

9. Fossilized footprints, worm burrows, ripple marks, and imprints of rain drops would have been made during the early weeks of the flood in sediments lifted above the flood waters by the fluttering crust. Minutes later, the crust submerged and new sediments gently buried these delicate imprints that are now called *trace fossils*. Today, without rapid burial and a source of gentle blanketing sediments mixed with cementing agents, trace fossils cannot be preserved. [See [Figure 105](#).]
10. Many fossilized fish are flattened between extremely thin sedimentary layers. This requires squeezing the fish to the thinness of a sheet of paper without damaging the thin sedimentary layers directly above and below. How could this happen?

Because dead fish usually float, something must have pressed the fish onto the seafloor. Even if tons of sediments were dumped through the water and on top of the fish, thin layers would not lie above and below the fish. Besides, it would take many thin layers, not one, to complete the burial. We do not see this happening today.

However, liquefaction would sort sediments into thousands of thin layers. During each wave cycle, liquefaction lenses would simultaneously form at various depths in the sedimentary column. Fish that floated up into a water lens would soon be flattened when the lens finally drained.

11. Sediments, such as sand and clay, are produced by eroding crystalline rock, including granite and basalt. Sedimentary rocks are cemented sediments. On the continents, they average more than a mile in thickness. Today, two-thirds of continental *surface* rocks are sedimentary; one-third is crystalline.

If the sediments we see today (including sedimentary rock) were produced by eroding crystalline rock *at Earth's surface*, the first blanket of eroded sediments would prevent the crystalline rock below from producing additional sediments. As more sediments are produced and deposited, fewer sediments could be produced. *Exposed* crystalline rock would disappear long before all today's sediments and sedimentary rocks could form. Transporting those new sediments, often great distances, is another difficulty. Clearly, most sediments did not come from the Earth's surface. They must have come from powerful subsurface erosion, as explained by the hydroplate theory, when high-velocity waters escaped from the subterranean chamber.

12. Some limestone layers are hundreds of feet thick. The standard geological explanation is that regions with those deposits were covered by incredibly limy (alkaline) water for millions of years—a toxic condition not found anywhere on Earth today. Liquefaction, on the other hand, would have quickly sorted limestone particles into vast sheets. [See “[The Origin of Limestone](#)” on pages 260–266.]
13. Conventional geology claims that coal layers, sometimes more than 100 feet thick, formed from 1,000-foot-thick layers of undecayed vegetation. Nowhere do we see that happening today. However, liquefaction would have quickly gathered vegetation buried during the early stages of the flood into thick layers, which would become coal after the confined, oxygen-free heating of the compression event.
14. Coal layers usually lie above and below *cyclothem*s, which sometimes extend over 100,000 square miles. If coal accumulated in peat bogs over millions of years (the standard explanation), why don't we see such vast swamps today? Why would a peat bog form a coal layer that was later buried by layers of sandstone, shale, limestone, and clay (generally in that ascending order)? Why would this sequence be found worldwide and sometimes be repeated vertically fifty or more times? To deposit a different sedimentary layer would require changes in environment and elevation—and, of course, millions of years. But liquefaction provides a simple, complete explanation.
15. Fossils are sorted vertically to some degree. Evolutionists attribute this to macroevolution. No known mechanism will cause macroevolution, and many evidences refute macroevolution. [See pages 5–25.] Liquefaction, an understood mechanism, would tend to sort animals and plants. If liquefaction occurred, one would expect some exceptions to this sorting order, but if macroevolution happened, no exceptions to the evolutionary order should be found. Many exceptions exist. [See “[Out-of-Sequence Fossils](#)” on page 13.]

16. Animals are directly or indirectly dependent on plants for food. However, geological formations frequently contain fossilized animals *without* fossilized plants.²⁷ How could the animals have survived? Evidently, liquefaction sorted and separated these animals and plants before fossilization occurred.
17. Meteorites are rarely found in deep sedimentary rock. [See “[Shallow Meteorites](#)” on page 40.] This is consistent only with rapidly deposited sediments.

Liquefaction During the Compression Event

While liquefaction operated during the flood phase, it acted massively once during the compression event, at the end of the continental-drift phase. [See pages 111–151.]

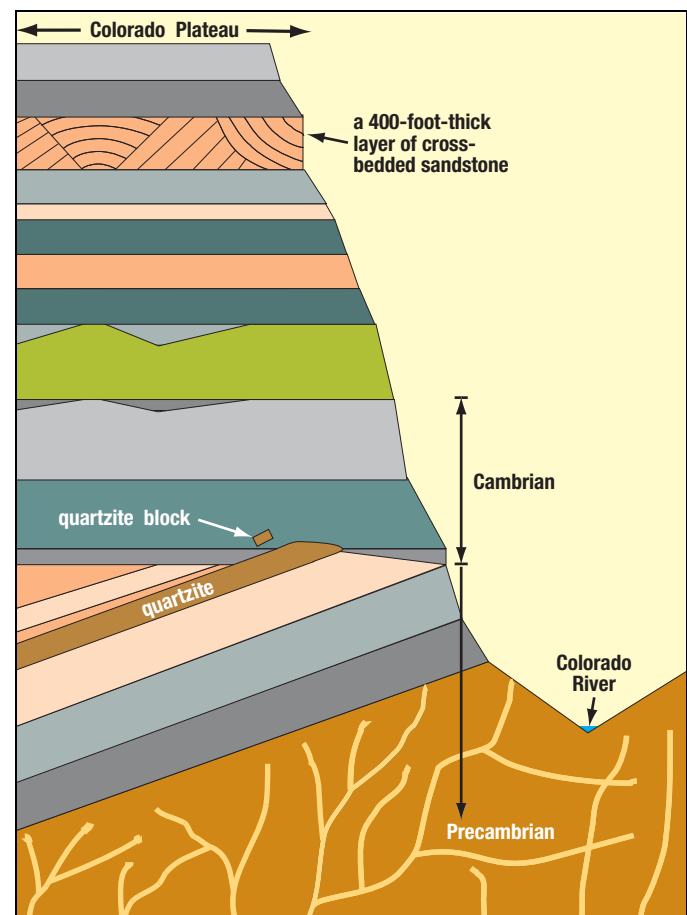

Figure 106: Grand Canyon Cross Section. The tipped and beveled layers are part of the Precambrian. The horizontal beveled plane, at the Cambrian-Precambrian interface, is sometimes called *The Great Unconformity*. A similar, but much smaller, example of tipped and beveled layers is shown in the cross-bedded sandstone in Figure 115. Beveling implies relative motion. Near the top of the Grand Canyon is a 400-foot-thick layer of cross-bedded sandstone. The white arrow points to the quartzite block shown in Figure 107.

Visualize a deck of cards sliding across a table. Friction from the table slows the bottom card. That card, in turn, applies a decelerating force on the second card from the bottom. If no card slips, the entire deck, including the top card, will



Figure 107: Transported Block in the Grand Canyon. In the left figure, notice the large, 5–10-ton block near the center, and the shadows of photographer Jim McDowell (my son-in-law) and two grandsons, Sean and Ryan McDowell. The right figure is an enlargement of the block with Ryan and Sean (left to right).

An article by geology professor Arthur V. Chadwick brought this block to my attention in 1978.²⁸ Later, we got to know each other when he visited my office. The block—a very hard material called *quartzite*—was lifted, transported from right to left, and deposited on layers which, at the time, were soft mud. Other mud layers then blanketed the block. (See the deformed layers below and above the block.) Professor Chadwick correctly identified the lifting force: a very dense, rapidly-flowing, sand/mud/water slurry, which plucked the block off the lower quartzite layer upstream (far to the right of these pictures). Part of that “pink” quartzite layer is seen in the first picture (lower right). The easiest way to lift and transport such a heavy block is in a dense liquefied (and therefore, very buoyant), sediment/water mixture that is flowing at a high velocity.

This rapid transport, which was immediately above the Cambrian-Precambrian interface, occurred during **the compression event**. Below the sliding slurry, a sand layer decelerated and compressed first. That compression squeezed up water that lubricated the slide and heated the quartz sand, so it became quartzite.²⁹ Compression also tipped the layers up, causing them to be beveled by the overriding, sliding layers. The camera is looking north; therefore, *the slurry slid from east to west, which is consistent with the direction the Americas hydroplate slid away from the Mid-Atlantic Ridge*. (Evolutionary geologists who do not understand the physics and the rapid continental drift that ended in the compression event, explain the flat Cambrian-Precambrian interface as a result of hundreds of millions of years of erosion. For them, unimaginable time explains everything. Lazy and sloppy thinking.)

See Figure 106 for a cross section of this region. The block is located at 36°7'34.80"N, 112°8'39.60"W. Hikers should not attempt to reach this remote, rugged, off-trail location unless they are in excellent physical condition and have permission from the Grand Canyon's Backcountry Office.

decelerate as a unit. But if a lubricant somehow built up between any two adjacent cards, cards above the lubricated layer would slide over the decelerating cards below.

Likewise, each decelerating granite hydroplate acted on the bottom sedimentary layer riding on the hydroplate. Sedimentary layers, from bottom to top, acted in turn to decelerate the topmost layers. As each water-saturated layer decelerated, it was severely compressed—similar to suddenly squeezing a wet sponge. Sediments, forced into a denser packing arrangement, released water. Sedimentary particles were crushed or broken, so their fragments filled the spaces between particles, releasing even more water. The freed water, then forced up through the sediments, caused massive liquefaction. As the sedimentary layers decelerated and compressed, they became more and more fluid. Eventually, some layers were so fluid that slippage occurred above them, as in our deck of cards. Below that level, extreme compression and liquefaction caused fossils to float up and collect at this watery level where sliding was taking place.

A major slippage surface is now called the Cambrian-Precambrian boundary. Fossils are found almost exclusively above this interface. Therefore, evolutionists interpret the Precambrian as about 90% of all geologic time—a vast period, they believe, before life evolved. A few feet above this global interface are found representatives of all animal and plant phyla. [See **“The Cambrian Explosion”** on page 12.] This presents a huge problem for evolutionists: How and why did so much life evolve so fast—a phenomenon evolutionists call “the Cambrian explosion”?³⁰ Again, evolutionists are unaware of global and massive liquefaction and mistakenly measure time by sedimentary layers and their fossils.

In the Grand Canyon, the Cambrian-Precambrian interface is an almost flat, horizontal surface exposed for 66 miles above the Colorado River. Layers above the Cambrian-Precambrian interface are generally horizontal, but layers below are tipped at large angles, and their tipped edges are beveled off horizontally. [See Figure 106.] As slippage began during the compression event, layers below the slippage plane continued to compress to the point where they

Key Requirements for Folding Strata, Buckling Mountains, and Overthrusting

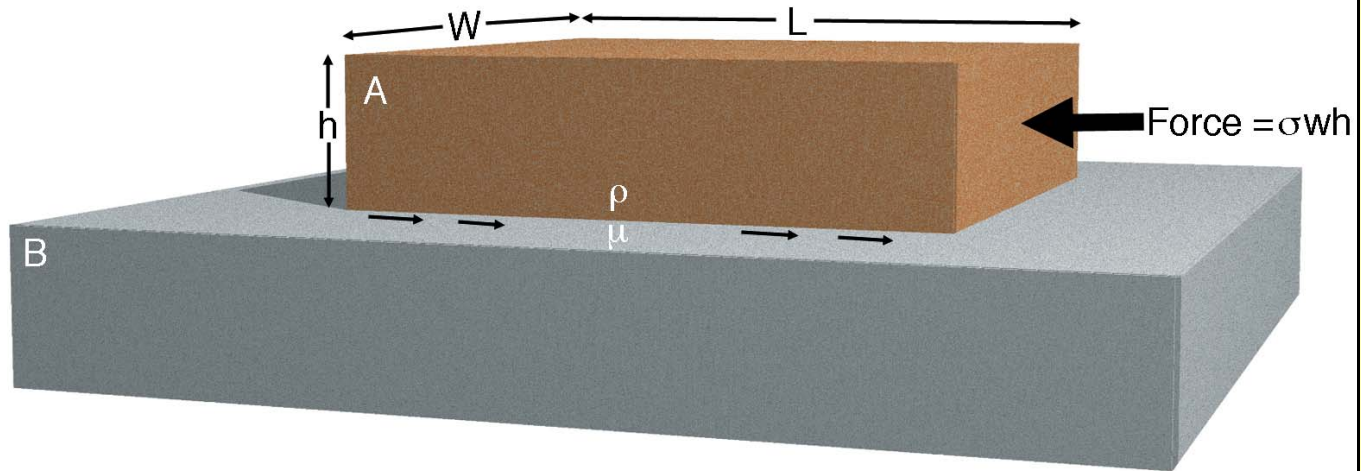

Figure 108: Hard-to-Satisfy Requirements for Overthrusting, Folding Strata, or Pushing Up Mountains.

Slab A has a length, height, width, and density of L , h , w , and ρ , respectively. It rests on horizontal surface B and is pushed from the right. The pressure or force trying to slide slab A over surface B exerts the maximum compressive stress, σ , on the right end of slab A. Any compressive stress greater than σ would crush slab A.

Let's assume that slab A is not bonded to anything—is a free body. Only static friction (with a coefficient μ) at the A-B interface resists movement. For motion to occur, the pushing force must exceed the resisting force, that is:

$$\sigma w h > \rho g (L w h) \mu$$

Page 593 gives the values for g , μ , and σ . For rock

$$\rho = 2.7 \frac{\text{gm}}{\text{cm}^3}$$

Therefore, slab A will move only if

$$L < \frac{\sigma}{\rho g \mu} = \frac{2 \times 10^9}{2.7 \times 980 \times 0.6} = 12.6 \times 10^5 \text{ cm} = 12.6 \text{ km}$$

In other words, if a flat slab of rock, resting on another flat rock, is longer than 12.6 km (8 miles), a compressive stress trying to slide that slab would crush it before movement could begin—regardless of the slab's other dimensions.

Conclusion: A rock slab longer than 8 miles cannot be pushed over unlubricated rock, so overthrusts, folded strata, and buckled mountains cannot occur in this way.

Simply folding a telephone book will produce slippage between adjacent pages. If those “pages” are rigid rock layers (or strata) at least 8 miles long, no matter how thin, folding cannot happen—without lubrication, crushing, or fracture. If the thrust layer is sandwiched between other layers, the additional friction greatly increases the difficulty.

The hydroplate theory automatically satisfies the assumption that slab A is a free body, because its material was deposited as water-saturated sediments during the flood, and the compression event, in crushing the crust, formed slabs.

Overthrusts are found on all continents, and millions of buckled and folded layers can be seen in mountains and road cuts around the globe. [See, for example, Figure 50 on page 117]. Therefore, something lubricated the overthrusts, and the layers at the time of folding were loose, water-saturated sediments that later lithified (hardened). All this began under a global ocean at the end of the flood, so plenty of water was available for each requirement.

The compression event also created temporary *liquefaction lenses*, on which rock slabs quickly overrode other slabs with essentially no friction. [See “**Liquefaction (Water) Lenses**” on page 198.] This explains why rubble is usually missing from such sliding interfaces, and why geologist Clifford Burdick's photographs of these interfaces show that sediments from the top slab were deposited through water onto the bottom slab.³¹

Unlike the high crushing stress which is necessary to slide slab A by pushing (if $L > 8$ miles), gravity sliding downhill achieves high velocities with little internal stress. That happened, according to the hydroplate theory, by the rising Mid-Atlantic Ridge and the subsiding Pacific hydroplate. Crushing and buckling finally occurred (1) near points where the lubricant was first depleted, (2) where an obstacle was encountered, or (3) where the overriding slab was relatively weak or thin.

The hydroplate theory meets all these requirements, thereby explaining how overthrusting and buckling occurred. In less than an hour³⁸ (during the compression event), Earth's mountain ranges formed in continental-size hydroplates.

Overthrusts: Two Possibilities

Evolutionists believe not only that life evolved, but that they know the evolutionary sequence and when each major group of animals and plants was on Earth. Therefore, evolutionists claim to know when the sediments fell through water and trapped, buried, and fossilized these animals and plants. This is primarily how evolutionists date sedimentary rocks. (Note the circular reasoning: *The fossils date the rocks, and the rocks date other fossils which then date other rocks—all of which seemingly supports evolution.*)

Some claim that radiometric dating confirms these dates, but that is not true. Comparing fossil dates with radiometric dates produces many contradictions. When these conflicts arise, one of the many problems with radiometric techniques (such as contamination) is usually given as the basis for rejecting the radiometric date and relying on the fossil technique, especially certain fossils called *index fossils*. [See “[Index Fossils](#)” on page 37.]

Imagine the evolutionists’ concern when they began to discover “older” fossils in rock layers *above* layers containing “younger” fossils.³² Leading creationists—notably George McCready Price³³ (1870–1963) and Henry Morris, Jr.³⁴ (1918–2006)—argued that these discoveries falsified evolution, because if evolution happened, the ages of rocks and fossils should increase with depth. Evolutionists then proposed that the older rocks must have slid up over younger rocks.³² How that could have happened has been a contentious issue for the past century. Physicists argue that friction prevents unlubricated slabs longer than 8 miles from sliding. [See page 204.] In response, geologists have maintained since 1959 that water in the pore spaces in rocks could flow out and lubricate the sliding surfaces.³⁵

Each side of this controversy made a mistake. Price and Morris incorrectly denied that overthrusting had occurred. Hundreds of drill holes have since shown that older fossils do lie above younger fossils at overthrusts—a reversal of the normal sequence. However, as this chapter has shown, the normal sequence is a consequence of liquefaction, not evolution. So overthrusting *has* occurred. Evolutionists are wrong in claiming that water could come out of the pore spaces of rocks fast enough for a slab (8 miles or longer) to slide over another slab. Even if the sliding surfaces were perfectly flat and smooth. Water’s viscosity is too high and the rock’s pore channels are too small for pore water to flow out fast enough.³⁶

Even more ridiculous, the volume of water that would need to come out of rock is completely unreasonable. The Lewis Overthrust in northwestern Montana and southern Alberta may be the most studied and famous of the hundreds of overthrust in the world. This 50-mile-long overriding slab slid about 80 miles. Evolutionists claim this sliding occurred for 15-million years—at the extremely slow rate at which they believe tectonic plates move. Recognize how little



Figure 109: Looking North at the Lewis Overthrust from the Marias Pass in Glacier National Park, Montana. The white horizontal rock halfway up the mountain is the Altyn Limestone. It marks the base of the top half of the mountain that geologists know slid eastward (to the right) approximately 80 miles to its present position! How could that have happened?

water can be held in the pore space of rock, and *imagine how much lubricating water would have leaked violently out of a high-pressure interface between the sliding surfaces in 15-million years!* (The water’s pressure at that interface had to be high enough to lift the thick overriding slab.) Seldom mentioned are the forces and energy needed to propel the overriding slab. Evolutionists surmise that the overriding slab was on a steep downhill slope, but many overthrusts, including the Lewis Overthrust are not on a steep downhill slope, as you can see in Figure 109. So how *did* overthrusting occur? In a word, quickly—during the compression event which lasted less than an hour.^{37, 38}

To their credit, evolutionists have correctly backed out the key requirements necessary to produce overthrusts, but have grossly underestimated the magnitudes needed for each requirement. However, the hydroplate theory, by beginning with the one major assumption on page 124 and then rigorously applying the laws of physics, easily explains these overthrusting magnitudes by applying both cause-to-effect reasoning and effect-to-cause reasoning. [See [Table 5](#).]

Table 5. Comparison of Two Explanations for Overthrusts

Requirements ³⁵	Possible Explanations	
	Evolution	Hydroplate
What is the source of the lubricating water?	In the pore space of a solid rock.	In loose, mile-thick, water-saturated sediments laid down months earlier through world-wide flood waters.
Where did the energy come from to move the overriding plate?	Maybe the overriding slab was on a steep slope that has since disappeared.	The sudden uplift of the steep Mid-Atlantic Ridge caused hydroplates to slide down the ridge on almost frictionless supercritical water.
What force moved the overriding plate?	Deceleration of a slowly sliding plate.	Deceleration of hydroplates that reached speeds of about 170 miles per hour. ³⁸
What forced the lubricating water into the high-pressure interface between sliding surfaces?	Slow gravity drainage within a solid rock.	The sudden compression event that also pushed up Earth’s major mountain ranges in less than an hour. ³⁸ It was like compressing a wet sponge.
What lifted the overriding slab up, so it could slide over the younger rock?	Unknown	Fluttering hydroplates during the continental-drift phase. ³⁹

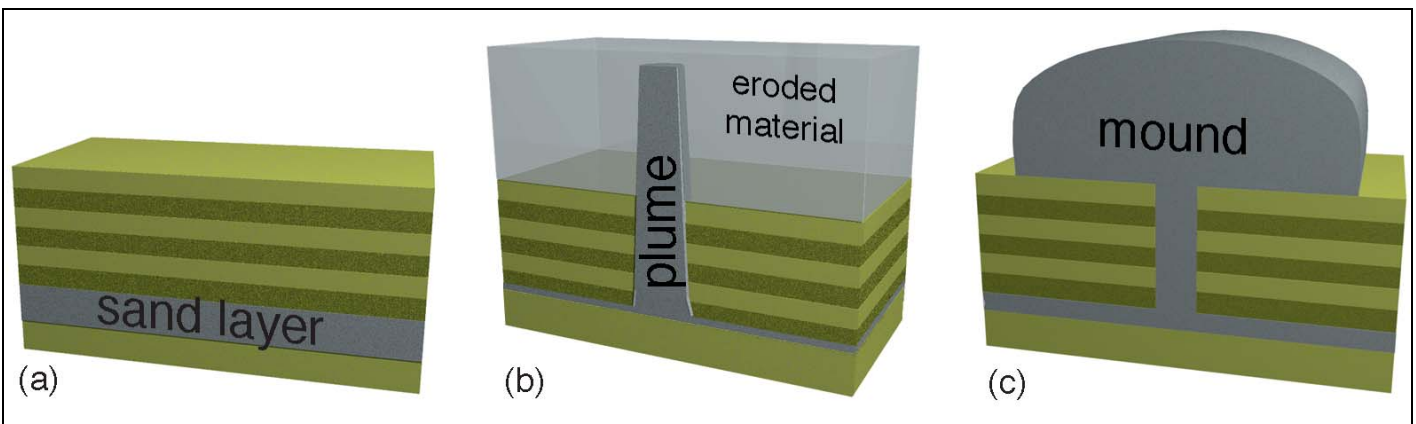

Figure 110: Formation of Liquefaction Plumes and Mounds. (a) During the flood phase, global liquefaction sorted water-saturated sediments into nearly horizontal layers. (b) During the compression event, massive liquefaction caused less-dense sand/water mixtures to float up as plumes, through denser overlying layers. (Figure 62 on page 129 shows a similar phenomenon.) Later, if surface layers were not cemented as well as the sandstone plume, the surface layers could erode away, leaving the harder, more-resistant plume exposed. (c) If a plume spilled out on the ground, a mound would form.



Figure 111: Liquefaction Plume 1. A hundred of these plumes are found in Kodachrome Basin State Reserve in south-central Utah, 10 miles east of Bryce Canyon National Park. I am standing at the bottom left of this tall plume.

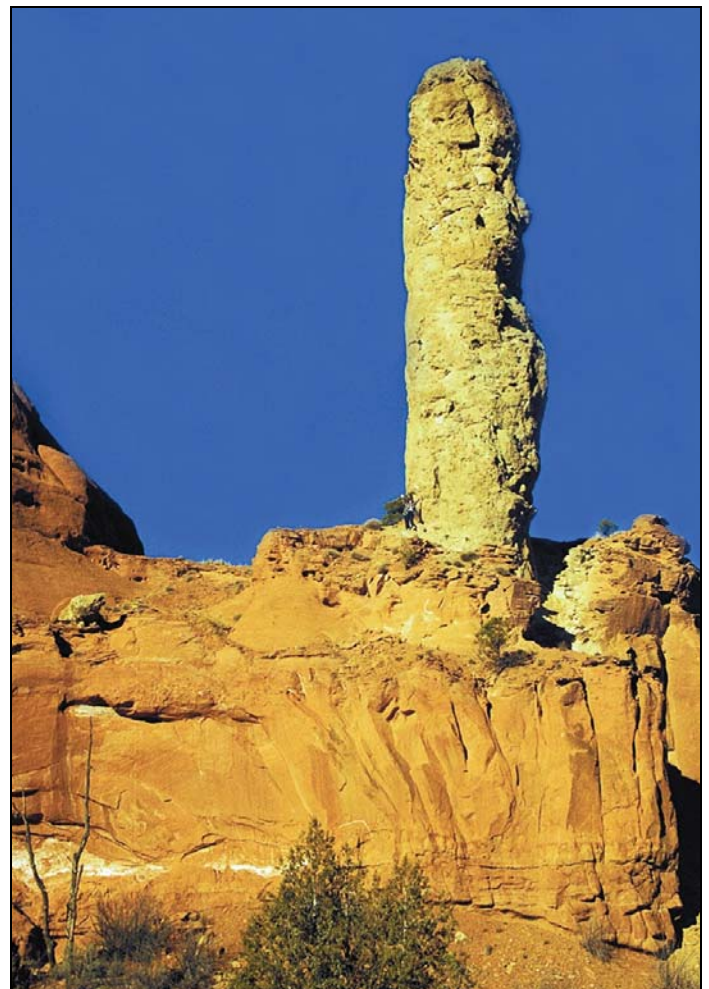

Figure 112: Liquefaction Plume 2. This plume can be traced down several hundred feet through the large rock in the bottom half of the picture. The plume rose from a specific horizontal sandstone layer that has identical chemical characteristics.⁴⁰ After the plume pushed upward, cementing occurred, with the sandstone plume becoming harder than the material it penetrated. Softer layers surrounding the plume later eroded away, leaving the plume exposed. [See Figure 110b.] Notice the person waving at the bottom left of this plume.



Figure 113: Liquefaction Mound.⁴¹ This and hundreds of similar sandstone mounds occupy the basin of the former Grand Lake. The breaching of Grand Lake carved the Grand Canyon. [See pages 215–257.]

The compression event produced massive liquefaction in water-saturated sand layers. During the few minutes the liquefaction lasted, some sand-water mixtures erupted, much like a volcano. Here, the eruption was onto the floor of Grand Lake. The large, mushy pile of sand quickly settled into the shape of an upside-down bowl. As the flood waters drained off the continents, this large, wet sand pile was protected, because it was deep in a lake. As the warm lake cooled, silica dissolved in the water was forced out of solution, thereby cementing the mound's sand grains. A century or so later, when Grand Lake spilled out, rushing water around the mound eroded the softer sediments on which the mound rested, producing the deep "moat" that separates the man at the lower right from the mound.

tipped. The sliding sedimentary block above the slippage plane beveled off the still soft tops of the tipped layers.

Evolutionists have a different interpretation. They believe tipped Precambrian layers are remnants of a former mountain range, because mountains today often have steeply tipped layers. [See [Figure 50 on page 117](#).] The tipped layers are horizontally beveled, so evolutionists say the top of the mountain must have eroded away. That, of course, would take a long time. Millions of years are also needed so seas could flood the area, because fossils of sea-bottom life are found just above the Cambrian-Precambrian interface. Within overlying layers, other fossils are found which required different environments, such as deserts or lagoons, so obviously, even more time is needed. (Unlimited time makes the nearly impossible seem possible—if you don't think too much about mechanisms.)

Cross-Bedded Sandstone. Sand layers had the greatest water content, because sand grains are somewhat rounded, leaving relatively large gaps for water between the particles. Therefore, sand layers were the most fluid during the massive liquefaction that accompanied the compression event. Deceleration forced the sand forward, displacing the water backward. Horizontally compressed sand layers would have slid, tipped, buckled, and beveled individual layers and blocks of layers, exactly what we see in cross-bedded sandstone. [See [Figure 115](#).]

Liquefaction Plumes and Mounds. The large water content of liquefied sand layers (40%) would have made them quite buoyant. Whenever a low-density, fluid layer (such as a water-sand mixture) underlies a denser, liquefied layer, the lighter fluid, if shaken, will float up



Figure 114: Ayers Rock. This popular tourist attraction in central Australia is 225 miles southwest of Alice Springs. Ayers Rock rises 1,140 feet from the desert floor and has a perimeter of 5.6 miles. Geologists who try to explain the origin of Ayers Rock say its sand came from the Musgrave mountain range 60 miles to the north and was dumped by water at its present spot. To account for its vertical layers, they say the rock "tipped," but the forces, energy, and mechanisms to do this are never explained. However, most geologists admit they do not know the origin of Ayers Rock.

Ayers Rock has characteristics of both a broad *liquefaction plume* and a *liquefaction mound*. [See [Figure 110](#).] Its surface layers (bedding) are nearly vertical, and they connect to a horizontal sandstone layer underground. It formed in the Amadeus Basin, whose contained waters covered and protected it while the flood waters drained from the Earth. Probably most soft sediments, through which the plume rose, were swept away when the basin's lake finally discharged. The many large holes in the sides of Ayers Rock show where water drained out. (Almost 20 miles away, this same, deep horizontal sandstone layer also connects to a series of liquefaction eruptions called *the Olgas*.)

The sand grains comprising Ayers Rock are jagged but, if exposed to rapid currents, would have become rounded. Had the grains been weathered for thousands of years, they would have become clay. Instead, these grain characteristics are consistent with the gentle currents produced by liquefaction and the rapid cementing in the years after the flood.

in plumes through the denser fluid. Sand plumes that penetrated overlying layers are seen in many places on Earth. [See [Figures 110–112](#).]

Some plumes, especially those rising from thick, laterally extensive sand layers, spilled onto the Earth's surface. This spilling-out resembled volcanic action, except water-saturated sand erupted, not lava. Small *liquefaction mounds*, as they will be called, appear when liquefaction occurs during earthquakes.⁴² [See Levin's description on [page 195](#).] Hundreds of liquefaction mounds are found in basins—former postflood lakes—in the southwestern United States.

Why basins? During the compression event, liquefied water-sand mixtures in many places erupted up onto lake bottoms. Being surrounded and permeated by water, they would have quickly slumped into the shape of an upside-down bowl—a liquefaction mound. As the flood waters drained at the end of the flood, most liquefaction mounds

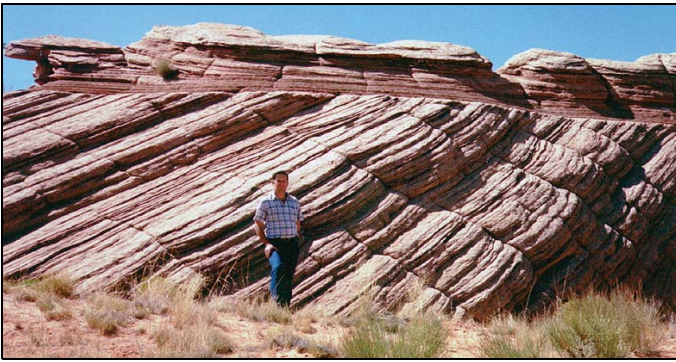

Figure 115: Cross-Bedded Sandstone. Dry sand can have a maximum slope of only 32 degrees. Cross-bedded sandstone, such as shown here, often has greater slopes. Therefore, this sand was probably wet when the layers tipped.

Notice that the top (nearly horizontal) layers obviously slid over and beveled the tops of the tipped layers below. Something, such as water was needed to lubricate the sliding, otherwise the horizontal layers would be wrinkled or crushed. But what was the lubricant, and what was its source? What confined the lubricant between the sliding surfaces? What tipped the lower layers, and what pushed the top, horizontal layers over the tipped layers?

As the compression event began near the end of the flood, these sediments—all horizontally layered by liquefaction during the flood phase of the preceding months—were riding on decelerating hydroplates. The deceleration rapidly compressed the water-saturated sand, just as your hands might horizontally compress a wet sponge. Water squeezed out of the wet sand formed a temporary liquefaction lens that decoupled the sliding layers above from the layers below that were being simultaneously tipped by the horizontal compression. The compression event was over in minutes.

Also notice that the tipped layers are slightly concave upward. Over long distances, this concave-upward pattern is often seen throughout the world's sedimentary layers. It occurs because a layer pushed horizontally (even if lubricated) would collide with what it is being pushed into. However, the more the layer is tipped upward, the less the resistance and the greater the thickening. Thus, these compressed and sheared layers are concave upward—increasingly tipped upward along their length and in the direction of their movement. The Appalachian Mountains are one of the most dramatic examples of this.

were swept away, because they did not have time to be cemented. However, mounds inside postflood lakes (basins) were cemented as each lake cooled and its dissolved silica and calcium carbonate were forced out of solution. If a lake later breached and dumped its water, the larger cemented mounds could resist the torrent of rushing water and retain their shapes. The basins that held Grand and Hopi Lakes, shown on page 214, contain hundreds of mounds, such as the one in Figure 113. The sudden breaching of those lakes several centuries after the flood carved the Grand Canyon. [See pages 215–257.]

Liquefaction mounds have holes in their sides showing where internal water escaped. The channels have collapsed except near the mound's surface where there was much less collapsing stress. Those holes now look like pock marks. Some have claimed they are erosion features from wind and rain. Obviously, wind and rain would smooth

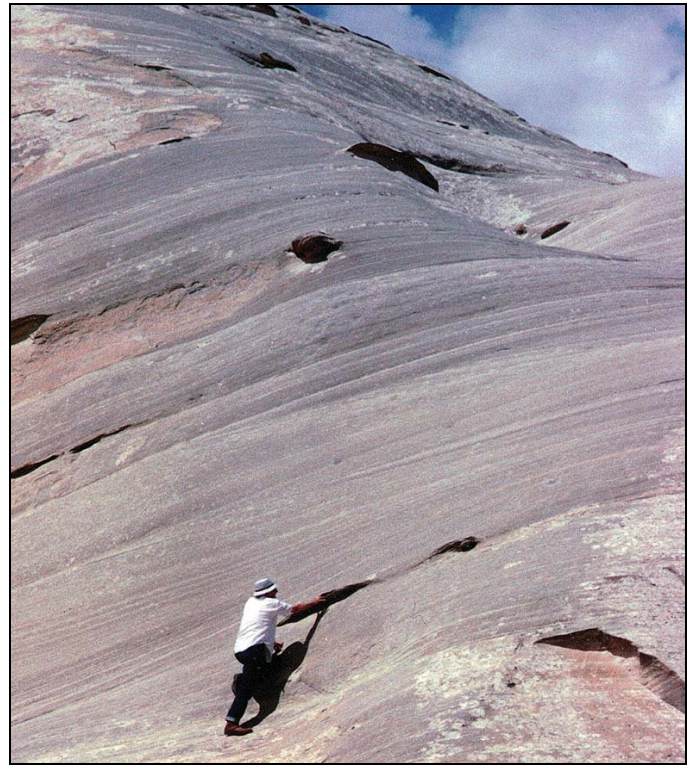

Figure 116: Medium-Sized Water Vents. Geology professor Dr. Douglas A. Block points to one of many holes in the side of a huge liquefaction mound in southern Utah. If these holes were places where rock was weakly cemented, similar holes should be on the tops of mounds. Instead, the tops are smooth. Cementing in mounds and cross-bedded sandstone is remarkably uniform and hard, showing that the cement was uniformly dissolved throughout water that saturated the sand.



Figure 117: Small Water Vents. These water vents are smaller than a pebble; others, such as those in Ayers Rock, are larger than a car. Water vents are quite different from the shallow and smooth bowl-like depressions which wind and rain erosion produced.

out pock marks, not make them. Besides, these “pock marks,” which will be called *water vents*, are found only



Figure 118: Ripples on the Continental Divide. These ripple marks, obviously made by water flowing powerfully⁴³ in the direction of my pencil, are found at dozens of locations, within a few hundred feet of the Continental Divide, along Hidden Lake Trail at Logan Pass in Glacier National Park, Montana.⁴⁴ (The Continental Divide is an imaginary line stretching from Alaska to the southern tip of South America—along the crest of the Rocky Mountain/Andes Mountain chains. Rain falling to the west of the Continental Divide flows toward the Pacific Ocean; rain falling to the east flows toward the Atlantic Ocean.) Below these rippled sandstone rocks are 7,000 feet of layered—and cemented—sedimentary rocks, whose sediments were deposited through water.

What sequence of events must have occurred to produce all this? First, about 7,000 feet of sediments had to be produced, then deposited on a seafloor and sorted into flat layers—all rapidly, because irregularities are only on top. Next, water had to flow powerfully over the uppermost layer to produce *nonsymmetrical ripple marks in wet sand*. But ripple marks are easily erased, just as sand castles on a beach are destroyed in a few days. Therefore, a thick layer of softer sediments (such as mud) had to rapidly blanket and protect the ripple marks. Then, the seafloor had to be pushed up to form the Rocky and Andes Mountains, a Herculean task requiring gigantic forces and energy. (Notice that plate tectonics provides neither.) Besides, the kinetic energy of a plate moving at only about an inch per year is so trivial that it could never push up a mountain.⁴⁵ Later, the sediments were cemented by chemical agents that had to be spread uniformly throughout the billions of cubic miles of loose sediments. Finally, erosion and weathering removed the blanket, exposing the cemented sandstone ripples.

Could the ripples have been formed at their present elevation (about 7,150 feet above sea level)? No. Earth does not have enough water to rise uniformly to that elevation. Even if there was at one time that much water, where did it go, and what could lift such thick layers of sediments that high? Could ripples form in high lakes and become cemented? We don't see that happening today, nor are the necessary chemicals present. Could the Rocky Mountains have been lifted slowly, over millions of years? The energy, forces, and mechanism for doing so have never been explained, but if the Rockies somehow did rise slowly, its peaks would experience the greatest erosion and weathering. Based on today's conditions and measurements, the mountain and its cemented ripple marks would erode faster than the mountain rose.

The hydroplate theory, supported by hundreds of other evidences, easily explains ripples on the Continental Divide. Sediments, eroded by the escaping subterranean waters during the flood, were quickly deposited through those waters. On the continents, those deposits average more than a mile in thickness. Liquefaction sorted most of them into the prominent layers we see today, and fluttering hydroplates produced gigantic waves, causing ripples even on the deep seafloor. The compression event buckled, crushed, and lifted the Rocky Mountains within an hour. (That lifting of the seafloor up through the water also caused a powerful, ripple-producing flow.) Prior to the flood, supercritical water in the subterranean chambers dissolved and uniformly spread cementing agents, such as silica and calcium carbonate, throughout the water. Months and years after the flood, the warm flood waters cooled, so those minerals came out of solution, lodged as precipitated solids (or cement) in the tiniest spaces between sedimentary grains. What were the forces, energy, and mechanism that produced ripples on the Continental Divide? Gravity, the kinetic energy of massive hydroplates sliding downhill, and buckling. [See also “**Seashells on Mountaintops**” on page 49, “**A Whale of a Tale**” on page 137, and Figure 50 on page 117.]

in the sides of mounds, not the tops, where they should be if outside erosion formed them.

For centuries after the flood, water drained out of mountains and cliffs. Caves were carved by outward flowing water. New inhabitants to an area sought out and settled around these plentiful sources of water. (Thus, many ancient cultures believed that water originated in mountains and flowed out of caves.)⁴⁶ Years later, as water sources dwindled, communities were forced to leave. Prosperous cultures, such as the Anasazi and cliff-dwellers, suddenly

disappeared from an area, causing anthropologists to wonder if disease, war, famine, or drought destroyed those ancient communities. No; their water simply dried up.

Final Thoughts

Before we examine the “grandest of canyons”—and the greatest geological laboratory on Earth—we should reflect on how the “**Two Faulty ‘Principles’**” described on page 199 produced centuries of confusion within the Earth sciences.

Without understanding the powerful events of the flood that produced flutter and liquefaction, one had to assume (1) that the slow, relatively uniform events we see today operated throughout Earth's history (*uniformitarianism*), and (2) that each sedimentary layer and its fossils were laid down sequentially worldwide over billions of years (*superposition*). Therefore, without understanding that layers

and fossils were rapidly sorted by liquefaction during the flood, people had to assume that billions of years were needed for a “magically produced” single cell to *somehow* develop into all plants and animals (*evolutionism*). Correcting these errors, now ingrained in the world's social fabric, will require a willingness by many to study, educate others, and follow the evidence wherever it leads.

References and Notes

1. Ivars Peterson, “Liquid Sand,” *Science News*, Vol. 128, 12 October 1985, p. 235.
2. Committee on Earthquake Engineering, George W. Housner, Chairman, Commission on Engineering and Technical Systems, National Research Council, *Liquefaction of Soils during Earthquakes* (Washington, D.C.: National Academy Press, 1985), pp. 25, 27.
3. Why does this phenomenon occur primarily with *sand* and not other sedimentary particles, such as clay? Clay particles are flat and platelike. They stack on top of each other like playing cards, so little water can flow up between the particles and produce liquefaction.

Resistance to the upward flow of a fluid between solid particles increases enormously as the space between the particles becomes very small, as in clay. However, sand particles are more rounded, creating much larger gaps between particles. A pile of dry sand is so porous that air occupies about 35% of its volume. Particles deposited in water, especially sand, will be almost completely surrounded by water, so water can flow up through sand with relative ease. Even clay particles that have settled through water will be largely surrounded by a film of water for some time. Therefore, wet clay particles will be buoyed up to some extent by the water, so liquefaction can occur.

Some people and most animals panic when caught in quicksand. Although they sink only to about half the depth they would in pure water (which is less buoyant), thick sand-water mixtures create a suction that opposes movement. Animals frequently die of exertion or starvation. If ever caught in *true* quicksand, relax, let the sand-water mixture support your weight, be patient, and slowly “swim” out of it.

However, a dangerous situation arises if the upward flow of water slows so that water pressure no longer lifts each sand particle. Stepping into such loose sand or mud might be like stepping into a deep pit filled with powder. How far you sink depends on how firmly the particles compact below you as you drop.

4. Harold L. Levin, *Contemporary Physical Geology*, 2nd edition (New York: Saunders College Publishing, 1986), p. 251.
5. Arthur N. Strahler, *Physical Geology* (New York: Harper & Row, Publishers, 1981), p. 202.
6. As the rocks settle into a denser packing arrangement, their potential energy is quickly converted into the energy of

pressurized water, which, in turn, will be converted into the kinetic energy of upward flowing water. That kinetic energy will be dissipated slowly as two types of friction.

The first occurs as the water flows up around the sedimentary particles. This frictional drag tends to lift each particle, although initially the upward force may not be enough to raise any particles. The second type occurs near the top of the bed of sediments. That is the point on the flow path where the pressure suddenly drops and, therefore, the flow velocity suddenly increases. If the velocity exceeds a specific threshold, the topmost particles will be lifted. This will remove weight from the particles directly below, allowing them to also rise. This chain reaction will continue down into the bed of sediments as long as enough energy remains. Particles lifted by water drag experience liquefaction.

7. “Breakthroughs in Science, Technology, and Medicine,” *Discover*, November 1992, p. 14.
8. Experiments have demonstrated this phenomenon as well. [See John T. Christian et al., “Large Diameter Underwater Pipeline for Nuclear Power Plant Designed Against Soil Liquefaction,” *Offshore Technology Conference Preprints*, Vol. 2, Houston, Texas, 6–8 May 1974, pp. 597–606.]
9. Bruce C. Heezen and Maurice Ewing, “Turbidity Currents and Submarine Slumps, and the 1929 Grand Banks Earthquake,” *American Journal of Science*, Vol. 250, December 1952, pp. 849–873.
10. “...the ocean floor in the neighborhood of the breaks is rather even with an average angle of slope with the horizon of 1°50' and that about half the breaks were on a slope of less than 1°.” *Ibid.*, p. 855.
11. A tsunami is often confused with a tidal wave. Tsunamis are caused by undersea earthquakes or volcanic eruptions that initiate a wave that is sometimes destructive. A tidal wave is a twice-daily, long-period wave caused by tides—the gravitational pull of the Sun and Moon on Earth.
12. Because liquefied sediments will flow on gradual slopes and become increasingly horizontal, most sedimentary layers today are horizontal. Bent or steeply tipped layers resulted from the compression event described on page 131.
13. George E. Anderson, mechanical engineer, suggested that water hammers acted during the flood.
14. Lester Haar et al., *NBS/NRC Steam Tables* (New York: Hemisphere Publishing Corporation, 1984), p. 218.

15. E. D. McKee et al., “Flood Deposits, Bijou Creek, Colorado, June 1965,” *Journal of Sedimentary Petrology*, Vol. 37, September 1967, pp. 829–851.
- ◆ Steven A. Austin, *Grand Canyon: Monument to Catastrophe* (Santee, California: Institute for Creation Research, 1994), pp. 36–39.
16. Water would flow into the sediment tank at about one centimeter per second. With a longer column of sediments, velocities are even slower. My computer simulations of liquefaction on the flooded Earth showed typical velocities of about 0.1 centimeter per second. Liquefaction would begin at the top of a thick column of sediment and would grow downward as the wave trough approached. Hundreds of feet of sediments could experience liquefaction at one time. If the flood waters deposited more sediments on top of the column before the next liquefaction cycle began, the lowest sediments liquefied in earlier cycles might not experience liquefaction again. *Thus, the least dense sediments will not all end up at the top of the sedimentary column.*
17. The old adage that water flows only downhill is not always true. Water flowed uphill in the water lens, because the pressure was highest in the lowest part of the lens where the weight of overlying sediments was greatest.
18. Personal communication, Dr. Karen Jensen, 8 January 2001.
19. When a water lens began to form, it spread rapidly, because water flowed into the lens more easily than it flowed out. Flow into a lens loosened the resisting sediments and very fine particles blocking the flow channels, while water trying to flow out of a lens (up or down) compacted the resisting sediments, allowing fine particles to plug up the flow channels. Also, water was captured in proportion to the lateral extent of the lens, so the larger a lens became, the faster it grew.
- During liquefaction, each sedimentary particle, surrounded by a thin film of water, would rotate and vibrate. The water’s flow around each irregular particle varied, causing sudden pressure changes that quickly altered forces all around the particle. (These are the same fluid forces that lift a wing, curve a baseball, or slice a golf ball.) When one particle collided with an adjacent particle, the effect would ripple “down the line” to some extent.
- With all this “microagitation” and lubrication, particles would arrange themselves into a very dense packing arrangement that would drive out more water. Later, close packing would aid in cementing each horizontal stratum between former water lenses into a strong unit. [See “[The Origin of Limestone](#)” on pages 260–266.] This is why horizontal cracks, called *joints*, separate strata.
- Evolutionists believe that the global occurrence of sharp, horizontal interfaces between adjacent strata show long time intervals in which the environment changed so drastically that different types of sediments were deposited. (The sources of these new sediments are never thoroughly explained.) On the contrary, sharp interfaces mark former liquefaction lenses.
20. In 1835, creationist Edward Blyth was the first to publish and explain natural selection and how it supports creation—not evolution. [See “Natural Selection” beginning on page 52.]
21. Leonard R. Brand and Thu Tang, “Fossil Vertebrate Footprints in the Coconino Sandstone (Permian) of Northern Arizona: Evidence for Underwater Origin,” *Geology*, Vol. 19, December 1991, pp. 1201–1204.
- ◆ “*The trackways (Fig. 4a–c) that were headed across the slope but with toes pointed upslope can perhaps be best explained by animals being pushed by a water current moving at an angle to the direction of their movement.*” Leonard R. Brand, “Field and Laboratory Studies on the Coconino Sandstone (Permian) Vertebrate Footprints and Their Paleocological Implications,” *Paleogeography, Paleoclimatology, Paleocology*, Vol. 28, 1979, p. 38.
22. The most authoritative source for geological definitions is the *Glossary of Geology*. It defines uniformitarianism as: *The fundamental principle or doctrine that geologic processes and natural laws now operating to modify the Earth’s crust have acted in the same regular manner and with essentially the same intensity throughout geologic time, and that past geologic events can be explained by phenomena and forces observable today; the classical concept that “the present is the key to the past.”* [See Robert L. Bates and Julia A. Jackson, editors, *Glossary of Geology*, 2nd edition (Falls Church, Virginia: American Geological Institute, 1980), p. 677.]
- The principle of uniformitarianism was meant to exclude a global flood, which many geologists still abhor—for philosophical, not scientific reasons.
23. “*The widespread deposition of such clean sand [in the St. Peter sandstone] may seem strange to a modern observer, since there is no region on earth where a comparable pattern of deposition can now be found.*” Steven M. Stanley, *Earth and Life through Time* (New York: W. H. Freeman and Co., 1986), pp. 355–356.
24. “*The United Nations Development Program notes that, in 2011, more than 40 countries experienced water stress; of those, 10 have nearly depleted their renewable freshwater supply. By 2050, one in four people globally may be hit by periodic shortages.*” Margaret Catley-Carlson, “The Emptying Well,” *Nature*, Vol. 542, 23 February 2017, p. 413.
25. *Thanks to Dr. Ian James Corrans in Australia who, on 24 July 2014, sent the following letter and acquainting me with jiggling.*
- Dear Dr. Brown,*
- I first read your book “In the Beginning-----” in March 2012. To put it mildly, this made a huge impact on my understanding of the geology of sedimentary rocks, ore deposits and coal and oil formation, etc. Since then I have re-read many chapters and pondered further on the vast amount of highly credible information that you have covered. I now believe “Flood Geology” is the real explanation for what lies as evidence before our eyes.*

Of particular interest to me is your discussion of the phenomenon of liquefaction as the origin of layered strata and fossils. This is absolutely correct in my view. During my working career, I was closely involved in mineral process engineering and mineral dressing. A well-known technique in mineral or ore dressing involves the use of the so-called “mineral dressing jig.” This is a device which imparts hydraulic (water) pulses to a bed of rock or mineral particles from below the bed. The particles are alternatively subjected to a lifting hydraulic force followed by a settling gravitational force. As a result the particles are sorted (i.e. stratified) according to density and size. A detailed description of the mineral dressing jig technique is available in any textbook on mineral dressing or on the internet.

Dr. Ian James Carrans

26. James W. Hagadorn et al., “Stranded on a Late Cambrian Shoreline: Medusae from Central Wisconsin,” *Geology*, Vol. 30, February 2002, pp. 147–150.
27. Ariel A. Roth, “Incomplete Ecosystems,” *Origins*, Vol. 21, No. 1, 1994, pp. 51–56.
28. Arthur V. Chadwick, “Megabreccias: Evidence for Catastrophism,” *Origins*, Vol. 5, No. 1, 1978, pp. 39–46.
29. To produce quartzite requires water and the extreme heating and compression of sand (quartz grains). The heating dissolves some of the quartz, placing silica (SiO₂) in solution. As water vapor escapes, the compressed mixture cools and the solution becomes supersaturated. Then the silica, acting as a cementing agent, precipitates (recrystallizes) on the remaining sand grains and fills the tiniest spaces. The silica cement becomes harder than the initial sand grains. (When quartzite is broken with a hammer, the break passes through the sand grains, not the silica cement.)

Liquefaction sorted the sediments into water-saturated layers, one of which was almost pure sand (quartz grains). The compression event provided the compression and heating. How else can one explain quartzite?
30. “The grand puzzle of the Cambrian explosion surely must rank as one of the most important outstanding mysteries in evolutionary biology.” Christopher J. Lowe, “What Led to the Metazoas’ Big Bang?” *Science*, Vol. 340, 7 June 2013, p. 1170.
31. “Photographs of contact lines indicate that the Precambrian strata were water deposited on top of the Cretaceous.” Clifford L. Burdick, “The Lewis Overthrust,” *Creation Research Society Quarterly*, Vol. 2, June 1969, p. 96.
 - ◆ For pictures, see Clifford L. Burdick, “Additional Notes Concerning the Lewis Thrust-Fault,” *Creation Research Society Quarterly*, Vol. 11, June 1974, p. 59.
32. “Older” and “younger” are relative terms. According to the hydroplate theory and liquefaction, an older fossil might have been permanently buried a minute before a younger fossil was buried in a layer several inches above. According to evolution thinking, an older fossil might have been buried several million years before that younger fossil in the layer above. The evolutionist would argue that it takes

millions of years for life forms to change and for enough dirt to fall through the atmosphere to do the burying.

33. George McCready Price, *The New Geology*, 2nd edition (Mountain View, California: Pacific Press Publishing Assn., 1923), 726 pp.
 - ◆ George McCready Price, *Evolutionary Geology and the New Catastrophism* (Mountain View, California: Pacific Press Publishing Assn., 1926).
 - ◆ George McCready Price, *Common-Sense Geology* (Mountain View, California: Pacific Press Publishing Assn., 1926).
34. John C. Whitcomb Jr. and Henry M. Morris, *The Genesis Flood* (Philadelphia, Pennsylvania: Presbyterian and Reformed Publishing Co., 1961), pp. 180–200.
35. Those who argue that water in the tiny pore spaces in rock could provide the necessary lubrication usually cite a 52-page paper by M. King Hubbert and William Rubey, entitled “Role of Fluid Pressure in Mechanics of Overthrust Faulting,” published in the *Bulletin of the Geological Society of America* in 1959. A key force overlooked in that paper is capillarity (due to the surface tension) of water *with respect to rock*. Just as you have seen a liquid rise in thin tubes (seemingly defying gravity), water molecules are attracted *to rock* and will resist flowing out of ultra thin channels in rock. Such thin channels would produce powerful capillary forces and would not allow enough lubrication.
36. This situation has been thoroughly analysed and can be found in many textbooks on fluid flow, under the heading *Hagen-Poiseuille flow*. For example, see Warren M. Rohsenow and Harry Y. Choi, *Heat, Mass, and Momentum Transfer* (Englewood Cliffs: Prentice-Hall, Inc., 1961), p. 36.
37. The overriding slab moved—*relative to the bottom slab*—to the right (east) in Figure 109. So you can see the slope requires the slab to move slightly uphill (based on today’s elevations), not downhill by gravity sliding. How could that happen?

Overthrusting was, in fact, driven by hydroplates sliding down the flanks of the Mid-Atlantic Ridge, which was suddenly uplifted by many miles. [See “**Continental-Drift Phase**” on page 130.] After accelerating downhill for most of one day, North America suddenly decelerated (due to either the loss of water lubricant below the 30-mile thick hydroplate or by colliding with a portion of the rising Mid-Oceanic Ridge (called the East-Pacific Rise) or both. (That Rise now runs under western California and produces frequent earthquakes). [See Endnote 49 on page 143.] The compression event pushed up the Rocky Mountains and produced massive liquefaction and many liquefaction lenses. [See “**Liquefaction During the Flood**” on page 197.]

The largest liquefaction lens isolated the water-saturated sediments above the lens from the water-saturated sediments below the lens. As that vast lens began to form, both blocks of sediments (above and below) were traveling west at the same speed. The Rocky Mountains were rising to the west, so their huge mass and inertia began retarding the top sediment block more than the bottom, more massive, sediment block.

As a result, the top block slid on the liquefaction lens to the east *relative to the block of sediments below the lens. Because the block below the lens had so much more mass and momentum, it continued to move westward.* Suspended in that thick liquefaction lens was a slurry of denser sediments (silicates) and less dense sediments (carbonates, primarily limestone). Naturally, the less dense particles rose relative to the denser particles, so limestone (today's Altyn Limestone) marks the thrust plane. It is easily seen as the white band exposed in many mountains in Glacier National Park. [See Figure 109.]

Another row could be added to Table 5 on page 205, asking "What accounts for the Altyn Limestone?" You have just read the explanation based on the hydroplate theory. Evolutionists would say that limestone is deposited in warm shallow seas, so the land had to subside below sea level, then become an isolated inland sea, and wait for enough evaporation to cause limestone to precipitate, or for enough shelled creatures to proliferate. Even if that could happen, it would require millions of years and many unsupportable events, such as the warming of cold Montana's frigid water. Finally, Glacier National Park would need to be lifted to its current elevation, more than a mile above sea level and display ripples on the Continental Divide, such as those shown in Figure 118. Quite a feat!

The Altyn Limestone is remarkably thin and uniform in thickness where it is seen throughout the 16,000 square miles of Glacier National Park. A large inland sea would not deposit limestone in a thin uniform layer. However, a liquefaction lens, which is itself thin, vast, and uniform in thickness would sort limestone out in a thin uniform layer.

38. See "[Could Earth's Mountain Ranges Form in Less Than an Hour?](#)" on pages 486–487.
39. Not only did flutter occur during the flood phase, it also occurred during the continental-drift phase. In explaining flutter in "[Water Hammers and Flutter Produced Gigantic Waves](#)" on page 197, the analogy of a flag fluttering in a wind was given. It does not matter if a flag is stationary and the air is moving or if the air is stationary and the flag is moving. Whenever a fluid (a gas or a liquid) has relative motion along a flexible surface (a flag, the wing of an aircraft, a vibrating reed in a musical instrument, or a hydroplate), resonant vibrations are easily set up. The faster and denser the fluid, the greater the flutter amplitudes. Compressed supercritical water is quite dense, and the relative velocity between the sliding, accelerating hydroplates and the water they rode on below was about 170 miles per hour! [See "[Could Earth's Mountain Ranges Form in Less Than an Hour?](#)" on page 486, and study Figure 243.] Therefore, flutter amplitudes were probably so extreme that sediment layers, underlain by a liquefaction lens, could easily have ruptured, allowing the water in one or more lenses to escape upward and carry the leading edge of sediment layers with it, riding up over the top-most layer.
40. Dwight Hornbacher, *Geology and Structure of Kodachrome Basin State Reserve and Vicinity, Kane and Garfield Counties, Utah* (Master's thesis, Loma Linda University, California, 1985).
41. This mound is located at 36°45'15.40"N, 109°34'45.87"W.

42. George Sheppard, "Small Sand Craters of Seismic Origin," *Nature*, Vol. 132, 30 December 1933, p. 1006.
43. These ripples have a shallow slope up to each ripple's crest, then a steep slope down from the crest. Therefore, the flow that produced these ripples was in one direction. Had the flow been in back-and-forth directions, as we see with waves near shore lines, each ripple's shape would be symmetrical. This means that the ripples were not made in shallow water. The deeper the water, the more powerful the flow must be to form ripples, especially nonsymmetrical ripples on the sea floor.
44. The ripple marks (located between 48°41'36.68"N, 113°43'36.97"W and 48°41'15.05"N, 113°44'16.54"W) are also mentioned by Becky Lomax in "Hidden Lake Overlook," *Glacier National Park* (Moon Handbooks, 2011), p. 100.
- ◆ "... ripple marks abound along the path from Logan Pass to Hidden Lake." David Alt and Donald W. Hyndman, *Roadside Geology of Montana* (Missoula, Montana: Mountain Press Publishing Company, 1986), p. 64.
45. A tectonic plate of mass m moves with a velocity v . If all its kinetic energy were used to elevate the plate and no energy was lost due to such things as friction, how high, h , could the entire plate rise?

kinetic energy ($\frac{1}{2} m v^2$) all becomes potential energy ($m g h$)

$$\frac{1}{2} m v^2 = m g h$$

$$h = \frac{v^2}{2g}$$

Today, crustal plates move about 4 cm/year—the rate a fingernail grows. [See Figure 94 on page 171.] Therefore,

$$h = \frac{(4 \text{ cm/yr})^2}{2 \times 980 \text{ cm/sec}^2} \times \left(\frac{\text{yr}}{31,556,736 \text{ sec}} \right)^2 = 8.2 \times 10^{-18} \text{ cm}$$

where g is the acceleration of gravity (or 980 cm/sec²) and 31,556,736 seconds are in a year. Even if just the central 10% of the plate rose, as in buckling or crushing, it would rise only 8.2×10^{-17} cm. Therefore, today's velocities of crustal plates couldn't possibly push up mountains.

Could millions of years of steady, but slight, pressure of one plate on another eventually push up mountains? Not anymore than logs in a river's log jam might steadily crush or buckle up over millions of years (assuming the logs did not disintegrate). Until the compression of one plate against another reaches a very high threshold—not even remotely reached by plate tectonics—the plates will not crush, buckle, or lift one iota. However, the compression event, at the end of the flood, easily explains how Earth's major mountain ranges were pushed up in less than an hour.

46. "[Spanish documents from the 16th century and scientists' interviews of the area's current inhabitants](#) [descendants of ancient Mayan (A.D. 200–900) peoples of central Mexico and Central America] *reveal a longstanding regional belief that water originates in mountains and issues out of caves.*" Bruce Bower, "Openings to the Underworld," *Science News*, Vol. 161, 18 May 2002, pp. 314–315.

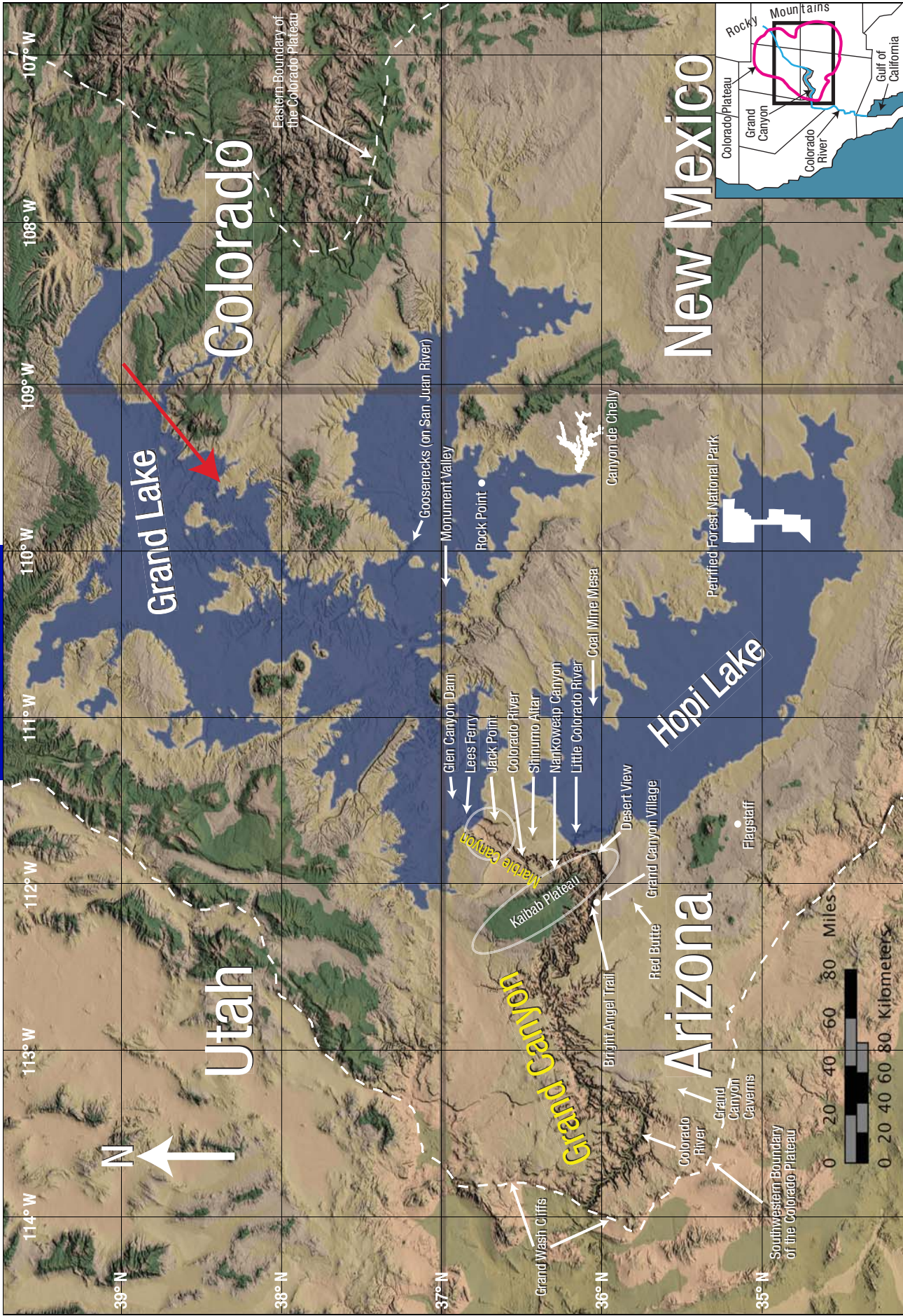

Figure 119: Geographic Features. Major geographic features described in this chapter are shown above. Two former lakes, Grand Lake and Hopi Lake, are superimposed on today's terrain, shown in nearly true color. The white oval encloses the high Kaibab Plateau, which extends slightly south of the Colorado River. The circle marks the north half of Marble Canyon, about a dozen barbed canyons, the funnel, and parts of Echo Cliffs and Vermilion Cliffs. All will be discussed later. The dashed white line marks the boundary of the uplifted, roughly circular Colorado Plateau, also shown in the inset. Grand Lake held a volume of water almost twice that of Lake Michigan. The volume of water in Hopi Lake was roughly that in Lake Huron.¹ To appreciate the size of Grand Lake, see Figure 140 on page 235. That photograph was taken in the direction of and from the tip of the red arrow above.

See Bryan Nickel's excellent, partially animated summary of this chapter at:

https://www.youtube.com/watch?v=DZ4eVMd3_PE&feature=youtu.be

The Origin of the Grand Canyon

SUMMARY: *Geologists admit that they do not know how the Grand Canyon formed, but for the last 140 years, they have insisted that the Colorado River carved the canyon over millions of years and somehow removed the evidence.² (Figure 43 on page 110 describes two obvious problems with that idea.) However, some so-called experts admit that the canyon's birth remains a "hazy mystery, cloaked in intrigue, and filled with enigmatic puzzles."³ After studying those puzzles, we will examine the eight main proposals for the Grand Canyon's origin and see why almost all experts reject them. Finally, we will consider two former postflood lakes—Grand Lake and Hopi (HO-pee) Lake—that several centuries after the flood, breached their boundaries and carved the Grand Canyon in weeks. This explanation not only unravels the confusion, but solves other major puzzles not previously associated with the Grand Canyon. For a quick explanation, see Figure 123 on page 220.*

The Grand Canyon is the best and most famous earth-science laboratory in the world. Although a few canyons are deeper or longer or steeper or wider, none is deeper *and* longer *and* steeper *and* wider—and none can compare with the Grand Canyon's scenic variety, massiveness, beauty, and three-dimensional exposure. It is 216 miles long,⁴ 4–18 miles wide, and about 1 mile deep. Writers correctly describe the canyon in such lofty terms as *magnificent, majestic, stupendous, inspirational, sublime, breath-taking, awesome, spellbinding, and Earth's greatest celebration of geology*. The first reaction of most of the 6 million annual visitors to the canyon is stunned silence.

Probably the foremost question visitors have is, "How did this happen?" Bruce Babbitt, former Governor of Arizona (1978–1987) and U.S. Secretary of the Interior (1993–2001), relates the answer given by John Hance. In 1883, Hance became the first white settler in the Grand Canyon. He was one of the canyon's most colorful personalities, tour guides, and explorers.

Children loved John Hance, and to them, he always explained how the canyon came into being. "I dug it," he would say simply. This story worked well for years until one little four-year-old girl asked seriously, "And where did you put the dirt?" Hance had no ready answer; he never used that story again. But it

bothered him the rest of his life, and when he was dying, he whispered to his waiting friends, "Where do you suppose I could have put that dirt?"⁵

That question still haunts geologists, because if the Colorado River carved the canyon, as commonly assumed, that dirt would have formed a gigantic river delta where the Colorado River enters the Gulf of California. Instead, the delta is relatively tiny—certainly compared to the vast volume of sediments that were removed to form the canyon.

Colorado River. Actually, the puzzle is much more difficult. Geologists now agree that the Colorado River began flowing out of the western Grand Canyon only recently. Here's why. Before the Glen Canyon Dam was built upstream from the Grand Canyon in 1963, the gritty Colorado River carried an average of 550,000 tons of sediment (sand, silt, and clay) out of the canyon each day—more than 5 tons each second!⁶ West of the Grand Canyon, the Colorado River cuts through a 650-foot-thick layer of Hualapai (WALL-uh-pie) Limestone whose topmost layers have been dated, using radiometric techniques, as less than 5,900,000 years old.⁷ If the river flowed through a lake that supposedly deposited this almost pure limestone, why are common river sediments not found in that limestone?⁸ Obviously, the river must have begun flowing there *after* that limestone was deposited—in geologic terms, recently. How recently? According to most geologists, within the last one-thousandth of the Earth's history!⁹

Three different types of similar, water-transported rocks are on opposite sides of the western Grand Canyon—rocks that could not have been transported from one side to the other if the canyon blocked the way.¹⁰ Therefore, those rocks were deposited before the Grand Canyon was cut through them and the Colorado River began flowing out of the western end of the Canyon. Since 1934, geologists have been trying unsuccessfully to find a previous location for the river or to learn why the river began so recently.¹¹

Kaibab (KI-bab) Plateau. A quick look at a relief map raises another question. *Why and how did the mighty Colorado River, flowing southward into northern Arizona along the east side of the Kaibab Plateau, suddenly make a right turn and flow west, up and over (or through) the high*

Kaibab Plateau? Rivers don't flow uphill! Desert View, an overlook on the Kaibab Plateau just south of the Colorado River, rises 5,800 feet above the river. Just across the river, the land rises even higher.

All attempts to explain the Grand Canyon's try to answer this question.¹² Some say the river was once a mile or more higher, and it flowed over and eroded a path down through the Kaibab Plateau—a process called *superposition*. Others say the river cut through the Kaibab Plateau along a fault (or crack). However, faults are generally perpendicular to the Colorado River, not parallel. Some believe that the land under the river somehow rose, forming the Kaibab Plateau. As it did, the river cut down through the rising plateau. Two theories say that a stream flowing westward, down a western slope of the Colorado Plateau, continually eroded *eastward* 130 miles and eventually cut through the Kaibab Plateau—a process called *headward erosion*. Notice how these untestable explanations require millions of years of time, but provide no physics-based mechanism. How many untestable explanations could be proposed if millions of years are imagined?

Missing Mesozoic Rock. Actually, cutting through the Kaibab Plateau is a relatively minor problem, and carving the entire Grand Canyon is not even half the problem. The Grand Canyon's rim consists of hard *Kaibab Limestone*, typically 350 feet thick. When you walk to the canyon's edge to look down, you are standing on Kaibab Limestone. It extends away from the canyon in all directions, covering about 10,000 square miles. However, rising 1,000 feet above this Kaibab Limestone at a few dozen isolated spots are softer (crumbly or weakly cemented) Mesozoic rocks; they are always capped on top by a very hard rock, such as lava. Obviously, lava did not flow up to the top; lava, which flows downhill, collected in a depression and hardened. Later, a fast-moving sheet of water flowed over northern Arizona and swept all the soft Mesozoic rock off the hard Kaibab Limestone—except for those few dozen spots which were capped and protected by hard rock.

Why was it a sheet of water? Falling rain would cut only channels. Flowing rivers or streams, even if they meandered for millions of years, would not uniformly sweep a 1,000-foot-thick layer of material off almost all of those 10,000 square miles of the fairly flat Kaibab Limestone. Besides, meandering rivers would produce meandering patterns. Therefore, before you can excavate 800 cubic miles of rock below the rim's Kaibab Limestone to form the Grand Canyon, something must sweep off almost all the Mesozoic rock above—a much larger excavation project. Surprisingly, the Mesozoic rock has also been swept off the Kaibab Plateau. How could water get so high? As you will see, the sweeping event, called *the Great Denudation*, caused the Kaibab Plateau to bulge upward.

Marble Canyon. To form the Grand Canyon requires first forming Marble Canyon, which is directly upstream (northeast) of the Grand Canyon. The two canyons join where the Little Colorado River enters the Colorado

The Great Denudation: Time or Intensity?

In 1882, pioneering geologist Clarence Edward Dutton showed that almost all Mesozoic rock (at least 2,000 cubic miles) had been swept off about 10,000 square miles of fairly flat Kaibab Limestone. This had to have happened first, before 800 cubic miles of deeper rock could be excavated to form the Grand Canyon. (To appreciate these volumes, recognize that all the water in the Earth's rivers totals only about 300 cubic miles.¹³) Dutton called this sweeping event *the Great Denudation*. He assumed that so much erosion required a very long time, but he overlooked another possibility: lots of violently flowing water spread over a wide area for a short time.

Few people realize that the Grand Canyon can deepen only when the water flow is violent, because up to 75 feet of silt, sand, gravel, and boulders cover and protect the bedrock under the Colorado River. Unless a violent flow removes that blanketing debris, the bedrock below cannot be scoured. Even before Glen Canyon Dam was built, periodic floods produced little bedrock scouring. What caused such a violent flow?

River. John Wesley Powell, who led the first known expedition through these canyons in 1869, mistakenly thought some of the water-polished limestone he saw was marble, so he named the canyon Marble Canyon. Marble Canyon is straighter, narrower, shorter (61 miles long), and has steeper walls. The two canyons are like two adjoining pipes; any explanation for one pipe should also explain the other pipe, even if they have differing shapes.

All the thin strata in and around Marble Canyon tip in directions that form a curious, but consistent, pattern. People floating southward inside Marble Canyon sense that they are rapidly falling. An optical illusion causes that sensation, because the strata inside the walls of Marble Canyon tip up to the south, so as one floats downstream, one rapidly moves past lower and lower layers in the narrow walls to the immediate left and right. Relative to a fixed point on the ground, one is only dropping about 8 feet each mile—a hardly perceptible rate.

If we look closely, we can see that the layers in Echo Cliffs (to the east) and Vermilion Cliffs (to the west) tip up toward Marble Canyon. At the southern end of these cliffs, the layers also tip up to the south, toward the Grand Canyon 30 miles away. [See Figure 127 on page 223.]

Later, you will see that the rapid removal of the dirt that formed Grand and Marble Canyons caused the surrounding regions to rise, just as removing one book from a stack of books resting on a spring scale will lift the remaining books.

Another unusual feature of these cliffs and others in the region is the lack of rubble, called *talus*, at the base of the

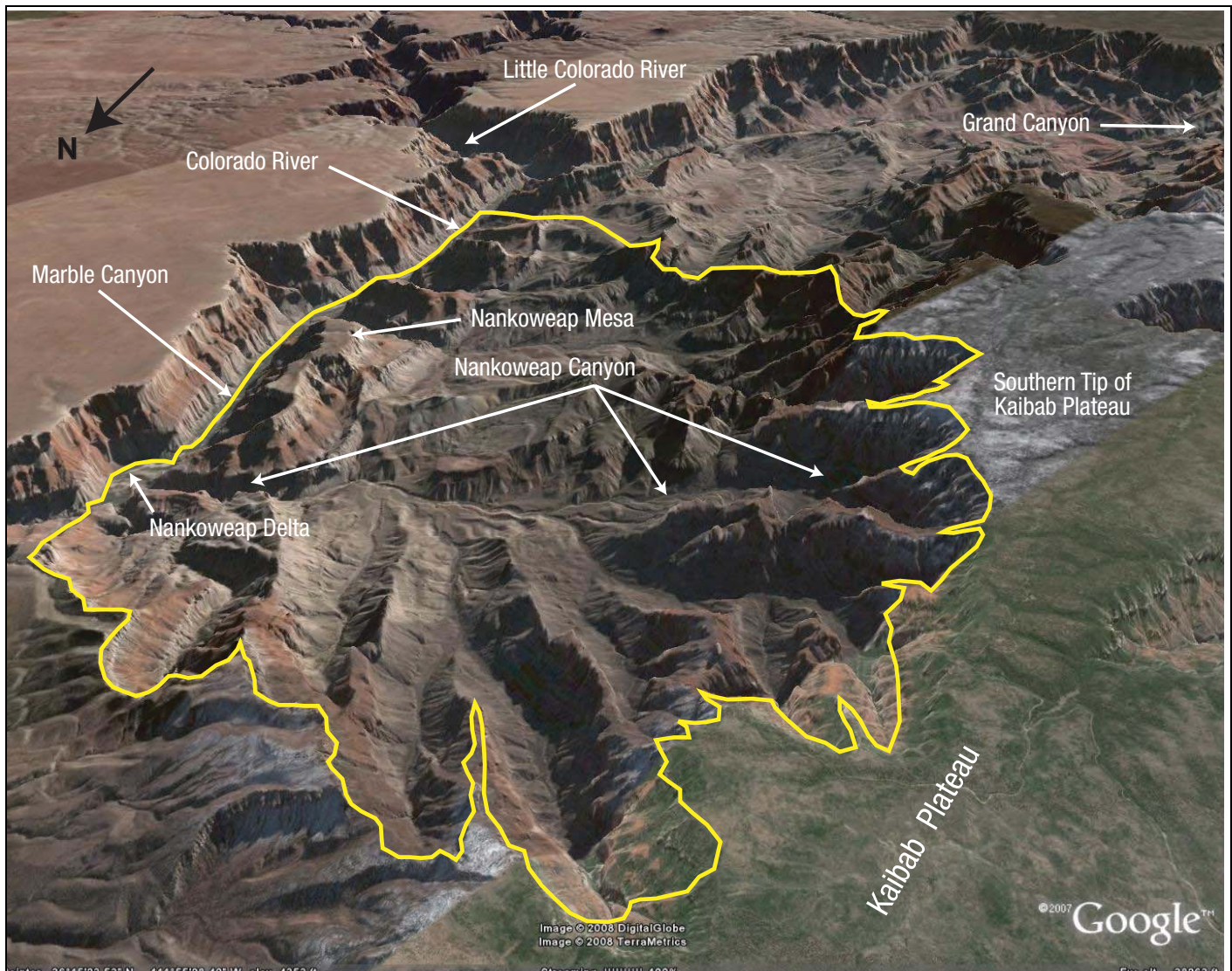

Figure 120: Nankoweap—Region of Unusual Erosion. This view is looking southeast from 38,000 feet above the ground. The Little Colorado River enters the southern end of Marble Canyon (at the top center). The yellow line encloses a region of unusual erosion. Notice that on the top of the high Kaibab Plateau, streams do not flow into the many canyons that cut into this southeastern portion of the Kaibab Plateau. So, what cut these side canyons, and why are they in such a localized area? Why would the terrain east of Marble Canyon, which is at least 2,000 feet below the top of the Kaibab Plateau and most of this erosion, be so smooth? On top of Nankoweap Mesa are slumps, landslides, and rockfalls. How can rocks fall and mud flow onto the top of a mesa?

cliffs. If freezing and thawing cycles acted for millions of years on the cliff faces, a sloping pile of loose rocks should be at the base of the cliffs. Even if the cliffs were young, lifting or carving cliffs should have left considerable talus.

Side Canyons. Dozens of large side canyons intersect the main trunk of Grand and Marble Canyons and cut down to the level of the Colorado River. If it took the powerful Colorado River millions of years to carve the Grand Canyon, why do all these side canyons, with no visible source of water, also cut down to the Colorado River? These side canyons also have their own side canyons, all connected like branches on a big, bushy tree.

Had these side canyons formed *before* the main trunk of Grand and Marble Canyons, most would extend through to the opposite side of the main trunk. They don't. Had these side canyons formed *after* Grand Canyon and

Marble Canyon formed, many would not cut down to the Colorado River, especially with no visible source of water to carve them. Therefore, these side canyons probably formed at the same time as Grand and Marble Canyons.

Some side canyons, called *slot canyons*, are much narrower than they are high. [See [Figure 142 on page 238.](#)] How could such narrow canyons be carved so deeply through hard rock?

A few side canyons are “barbed.” That is, they connect to the main canyon “backwards,” similar to the barbs in barbed wire or fishhooks. Tributaries almost always enter rivers at acute angles, but the barbed canyons enter at obtuse angles. Very strange.¹⁴ What happened?

Nankoweap Canyon. One large side canyon, *Nankoweap* (NAN-ko-weep) Canyon, enters the Colorado River from the west, near the southern end of Marble Canyon. [See

Distant Cavern Connection

In 1958, the U.S. Army Corps of Engineers, in preparing a fallout shelter, set off red smoke bombs inside Dinosaur Caverns, a large limestone cavern far south of the Grand Canyon. Two weeks later, park rangers saw that red smoke exiting into the Grand Canyon, **63 miles** from the cavern. These caverns, now called Grand Canyon Caverns, have four larger caverns lying up to 1,500 feet below this first cavern.¹⁵

Obviously, the uplift of the Colorado Plateau predated the Grand Canyon; the Grand Canyon predated this 63-mile-long, underground drainage system, and a large volume of groundwater (5,400 feet above sea level) was needed to form this deep, multilevel cavern system. Millions of years of rainfall would not have accomplished much deep excavation. This cavern is one of the driest in the world. Besides, all sedimentary layers south of the Grand Canyon slope down to the south, so rainwater would not drain north toward the Grand Canyon. [See Figure 121.]

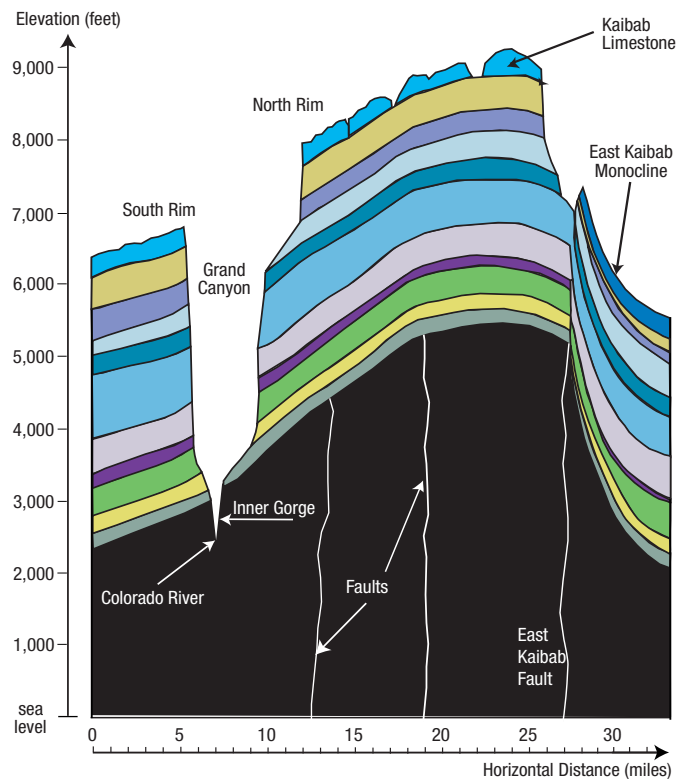

Figure 121: Grand Canyon Profile. This profile, showing the thickness, shape, and elevation of each of the major sedimentary layers, extends from 36°00'N, 112°17'W to 36°24'N, 111°56'W.¹⁷ Basement (nonsedimentary) rock is in black. Note the differing scales (vertical in feet, and horizontal in miles). At these scales, the Colorado River, at the tip of the left arrow above, would be smaller than the period at the end of this sentence. (Could that “dot of a river” carve the huge, wide canyon above it?) In general, Grand and Marble Canyons cut down into a broad arch that extends for the length of those canyons. This particular profile cuts across faults; one of the most dramatic aligns with the East Kaibab Monocline, which will be discussed later. Notice how the layers under the monocline thicken to the right.

Figure 120.] Nankoweap Canyon has at least 40 archaeological sites, including granaries, but today is usually dry and barren, although, at times, Nankoweap Creek flows.

Nankoweap Canyon begins high on the southeastern slope of the Kaibab Plateau. Water flowing from many directions cut this side canyon and its many tributaries producing avalanches and mudflows. The mineral composition of the boulders mixed in this debris shows that the avalanche came out of and off the Kaibab Plateau. These flows had to be voluminous, recent, violent, and fast. The flow was voluminous and recent, because it produced Nankoweap Delta, the Grand Canyon's *largest tributary delta*. If, as some mistakenly believe, the Colorado River was powerful enough to cut through solid rock and carve the entire canyon, why did it not remove this soft delta? The flow was violent and fast, because large, partially rounded boulders lie up to 200 feet high on both sides of the last 1,000 feet of Nankoweap Creek. Some of the lower boulders are taller than a man.¹⁶

The Great Unconformity. Fossils are found only in the layers *above* an almost perfectly horizontal plane called *the Great Unconformity*. Evolutionists believe this boundary marks the time when all life on Earth began and name it *the Cambrian Explosion*. [See “The Cambrian Explosion on” page 12.] In the Grand Canyon, it lies about 4,000 feet below the rim and extends above the Colorado River for 66 miles. Above the Great Unconformity the layers are all sedimentary and usually horizontal; below the Great Unconformity lie either basement (crystalline) rock or thick, sedimentary layers that slope 10°–20°.

Arching. Researchers have long noted that Grand Canyon and Marble Canyon lie on a long, 277-mile arch. Vertical cross-sections (perpendicular to the Colorado River) show how the sedimentary layers and basement rock directly below, arch upward.¹⁸ Each cross-section differs slightly, depending on its location. For 46 miles along the highest portion of the arch, the canyon descends into the dark basement rock itself—a steep slot (up to 1,200 feet deep) called *the inner gorge*. [See Figures 121 and 122.] Immediately above this inner gorge lies the Great Unconformity, above which lie horizontal sedimentary layers stacked almost a mile high.

Our Focus. While the key question concerning the Grand Canyon is how did it form, other matters can easily distract us: the canyon's beauty, modern history, early habitation, and exploration; the mind-numbing list of geologic terms and terrain names; and the adventure and stress of navigating its many trails and the Colorado River itself. Hundreds of books have already told these stories, so we will avoid those fascinating diversions and focus on the key question of the



Figure 122: Inner Gorge. How could a river cut a slot, up to 1,200 feet deep, into such hard, crystalline (nonsedimentary) rock? When a river erodes down through soft sedimentary layers and encounters hard basement rock, further erosion should be primarily horizontal, into the softer, flanking sedimentary layers. Any erosion into the harder rock would form a shallow, bowl-shaped channel, not a deep, nearly vertical cut. The eroded walls of this inner gorge should be smooth, but instead, are jagged. Besides, if the river started to cut a deep slot, boulders (not easily moved by even a fast-flowing river) would fill the bottom of that slot, preventing further scouring and deepening of the slot. [See in Figure 121 what appears to be a deep tension crack that formed as the mile-deep sedimentary layers were eroded to form the Grand Canyon. With that removal of weight, the basement rock below the Canyon arched up and cracked vertically.]

Grand Canyon's origin. A reward may await us. As usually happens in science—and as you are hopefully seeing with the flood itself—when a persistent enigma is finally solved, answers to seemingly unrelated problems become obvious.

Evidence Requiring an Explanation

Summarized below are the hard-to-explain details which any satisfactory explanation for the origin of the Grand Canyon should answer.

Layering. Probably the most striking sight at the Grand Canyon is the vastness of the parallel sedimentary layers—multicolored by their differing mineral and chemical content. Any explanation for the Grand Canyon's layers

should also explain other sedimentary layers worldwide, because they are so similar (although less dramatic).

Limestone. The Hualapai Limestone, west of the Grand Canyon, was deposited before the Colorado River flowed out the western end of the Grand Canyon. Also, many layers in the canyon consist primarily of limestone hundreds of feet thick.¹⁹ What is the source of so much limestone, and what concentrated it? If these limestone layers were deposited in shallow inland seas—the standard explanation—then the Colorado Plateau had to rise and fall at least once per layer. Explaining one lift is difficult enough.²⁰

Marble Canyon. How does the origin of the nearly straight Marble Canyon and its narrow, vertical walls relate to the origin of the adjoining, but broader, Grand Canyon? What accounts for the strange pattern of tipped layers in the walls of Marble Canyon and Echo and Vermilion Cliffs?

Distant Cavern Connection. How could a deep and dry underground cavern develop 5,400 feet above sea level and then drain for 63-miles into the Grand Canyon?

Side Canyons. Why do Grand Canyon and Marble Canyon have so many side canyons that were cut as deeply as the main canyons but without a visible source of water?

Barbed Canyons. Why does Marble Canyon have large, barbed (backward) side canyons?

Slot Canyons. How did such narrow side canyons with jagged walls capture enough water to cut deep channels that drain into the Colorado River? Why are most of the world's slot canyons on the Colorado Plateau?

Perpendicular Faults. Why are the dozens of faults in the Grand Canyon generally perpendicular to the Colorado River, and why doesn't the river flow along an "easier" path provided by a fault?²¹ Maybe the faults formed as a result of—and after—the deep erosion that formed the river's channel.

Arching. Why are Grand and Marble Canyons cut into and along the top of a broad, upward-pointing arch that extends, in general, for the 277-mile length of those canyons?

Inner Gorge. Why are the walls of the inner gorge so deep, steep, narrow, and rough? How could a river cut so deeply into such hard rock at the inner gorge but not as deeply into softer rock both upstream and downstream?

Nankoweap Canyon. Why did humans live for centuries in this now dry, desolate canyon? What produced the avalanche and provided a violent, multidirectional flow of water able to (1) carve Nankoweap Canyon and its side canyons, (2) create a large delta that remains today despite the cross-flowing Colorado River, and (3) stack thousands of large, rounded boulders 100–200 feet high along Nankoweap Creek? Where was enough water to do all that?

Unusual Erosion. Why are slumps, landslides, and rockfalls found on the top of Nankoweap Mesa? Why does the

Colorado River sharply delineate this eroded region to the west from the smooth, lower region to the east?

Forces, Energy, and Mechanisms. Each explanation for the Grand Canyon requires lifting the Colorado Plateau more than a mile in the air and excavating and transporting thousands of cubic miles of rock. Are the forces, energy, and mechanisms for these movements known—or merely inferred or assumed? Without a knowledge of the underlying physics, which must conform to scientific laws, major errors can creep in. Even if the inferences or assumptions are correct, ignorance of the actual forces, energy, and mechanisms will blind us to root causes, rates, and other consequences. Predictions will not present themselves; modeling and testing become limited. Such “half baked” explanations simply confuse others.²²

Why Here? Why is the Grand Canyon where it is, and why are there not many other “grand canyons” worldwide?²³ The canyon receives little rain. If an explanation claims that over millions of years, a set of conditions, such as a fast-flowing river produced the Grand Canyon, then dozens of other “Grand Canyons” should exist where those conditions are even more extreme.

Why So “Recently”? If a powerful river carved the Grand Canyon during the last one-thousandth of Earth’s history, why didn’t more powerful rivers carve other “Grand Canyons”?

Missing River. Limestone was deposited at the western end of the Grand Canyon before the Colorado River flowed through the canyon. Where was the river? What brought it to its present location? How was the western Grand Canyon carved?

Missing Talus. In the canyon region, why do steep cliffs, such as Echo Cliffs, Vermilion Cliffs, and others, have little talus (rubble) at their bases?

Kaibab Plateau. Why and how did the Colorado River make a right turn and cut up through the Kaibab Plateau, which rises more than a mile on either side of the river? What caused the Kaibab Plateau to bulge upward, like a squeezed water balloon?

Colorado Plateau. A *plateau* is large region whose horizontal sedimentary layers were lifted relative to the corresponding layers surrounding the plateau.²⁴ The Colorado Plateau rises an average of 6,200 feet above sea level. The 1-mile-deep Grand Canyon could never have formed on land that is less than a mile above sea level. So what lifted the Colorado Plateau?

*For all its glorious views, the Colorado Plateau remains an ugly mystery to geologists. They can’t figure out why and how it rose thousands of feet over the millions of years it took to carve spectacular natural wonders like the Grand Canyon and Monument Valley.*²⁵

Missing Mesozoic Rock. What swept off the soft, 1,000-foot-thick Mesozoic layer, from atop 10,000 square miles of hard, horizontal Kaibab Limestone? How could that layer have been swept off the much higher Kaibab Plateau?

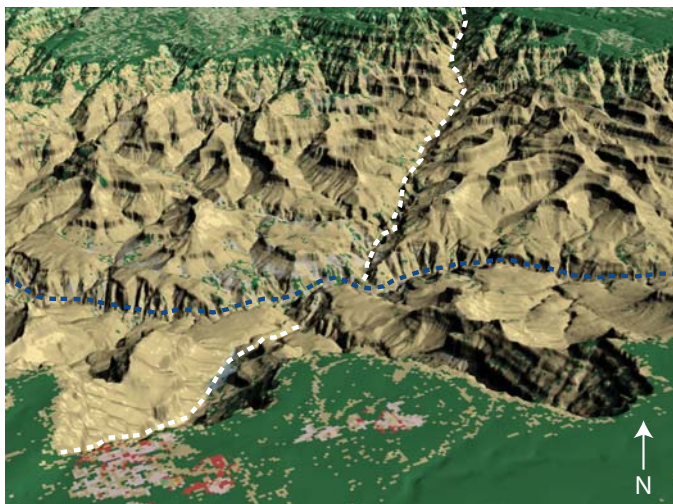

Figure 123: Grand Canyon in 3D. Grand Canyon Village is at the bottom of this computer generated picture; the Colorado River lies below the dashed blue line. Obviously, a river did not carve all the randomly oriented drainage channels that make up the Grand Canyon. And yet, that is what the public has been told for 150 years. No wonder the standard explanation—that the Colorado River carved the Grand Canyon—has so many recognized problems, even in the eyes of the so-called experts.

Surface water typically flows downhill; however, the flow of subsurface water depends in part on the location of faults and other subsurface drainage channels. Sediments deposited on the continents by the flood averaged more than a mile in depth all over the Earth. Each grain that settled through the muddy flood waters helped trap water between the loosely packed grains. When the flood ended, approximately 20% of the flood water was temporarily held between sedimentary grains, seeking ways to escape to the surface. Water that escaped accounts for many of today’s land features, including much of the Grand Canyon.

Part of the 60-mile-long Bright Angel Fault is shown by the dashed white line. This vertical fault (a deep fracture) has been lifted up to 200 feet on its west side which allowed subsurface water to escape out of the freshly exposed 200-foot-high cliff face and up out of the fault. That erosion carved the prominent Bright Angel side canyon, the location of the famous Bright Angel Trail. Hundreds of less spectacular faults account for hundreds of other variously oriented valleys and side canyons that allowed escaping subsurface water to drain down to the deepest channel, where the Colorado River now flows. In other words, **the Grand Canyon was carved first; then, the region’s natural drainage created today’s Colorado River.**

Missing Dirt. About 2,800 cubic miles of dirt had to be removed to carve the Grand Canyon. The Colorado River’s delta does not contain even 1% of that dirt. Where did it go? Was there enough water to transport all that dirt?

Fossils. Why are fossils found only above the Great Unconformity?

Tipped Layers. Why are sedimentary layers (hundreds of feet thick) tipped at steep angles below portions of the Great Unconformity, while the layers above, averaging 4,000 feet in total depth, are essentially horizontal?

Time or Intensity? A satisfactory proposal for carving the Grand Canyon must show, in a self-consistent way, that eons of time transpired, or there was a violent flow of water.

Proposals for the Origin of the Grand Canyon

Although not addressing the Grand Canyon, several early geologists suggested a mechanism for carving a canyon: breaching a large lake's boundary. If a large lake spills over the lowest point on its boundary, a notch will be cut that will allow more water to flow through the notch faster, eroding the notch even deeper. If the lake is large, the initial loss of water will not lower the lake's level too much, but the notch will deepen rapidly. The lake will discharge catastrophically through a deepening slit—quickly forming a canyon.²⁶ The process is similar to the collapse of a dam. Modern examples of breached dams include the 1889 Johnstown Flood in Pennsylvania, which killed at least 2,200 people, and the 1976 Teton Flood in Idaho, which killed fourteen people and left 25,000 homeless.

In 1861, John Strong Newberry proposed an explanation for the small canyons and basins along the Colorado River *far south and west of the Grand Canyon*. He wrote:

*Doubtless in earlier times [the Colorado River] filled these basins to the brim, thus irrigating and enriching all its course. In the lapse of ages, however, its accumulated waters, pouring over the lowest points in the barriers which opposed their progress towards the sea, have cut them down from summit to base forming that remarkable series of deep and narrow cañons through which its turbid waters now flow, with rapid and almost unobstructed current, from source to mouth.*²⁷

Newberry also wrote that the Grand Canyon, which he called *The Great Cañon*, was “wholly due to the action of water. Probably nowhere in the world has the action of this agent [water] produced results so surprising, both as regards their magnitude and their peculiar character.”²⁸

In 1923, another geologist, J Harlen Bretz, proposed that a network of canyons had been carved in Washington State by the breaching of a natural dam. He said that an ice dam impounded a lake in Montana and northern Idaho. The lake, which Bretz called *Lake Missoula*, held about half as much water as Lake Michigan. (Grand Lake alone held twice as much water.) When Lake Missoula breached, canyons and other terrain, called *the Channeled Scablands*, were carved. Because Bretz's explanation was too catastrophic and similar to the biblical flood,²⁹ geologists rejected his views for more than 40 years. Today, his views are widely accepted.³⁰ (Invoking catastrophes violated a “sacred” rule in geology; i.e., explanations should involve only processes that we see today. Evolutionary geologists believe that eons of time were available. Unfortunately, this assumption, called *uniformitarianism*, still underlies much of geology.)

The following are the best-known published proposals for the origin of the Grand Canyon. Most assume that the Colorado River carved the canyon. All theories try to explain how the Colorado River traversed the high Kaibab

Plateau. Proposals made when little was known about the canyon and surrounding region contain few details.

John Wesley Powell (1869). Over geologic time, thousands of feet of limestone, shale, and sandstone layers were deposited. The Earth, cooling from its earlier molten state, was contracting and shriveling, like a dried-up, wrinkled apple. As the Colorado River flowed along its present course 65,000,000 years ago, surface rocks began folding, uplifting, and tilting. The Colorado Plateau rose so slowly that the river was never blocked. As it did, the river cut down through the rising land, leaving the Grand Canyon.³¹

In fairness to Powell, who had lost an arm during the civil War, the mechanism he proposed for the Grand Canyon's origin was based on terrain he saw two months before he entered the Grand Canyon and 400 miles to the northeast. When his group reached the Grand Canyon, they were in a race for their lives, rations were running low, treacherous rapids were smashing their small wooden boats, morale was low, escape routes were limited, and constraining canyon walls permitted little exploration. Two weeks later, three team members were killed as they tried to leave that hostile environment.

Grove Karl Gilbert (1875). Faults developed in the Colorado Plateau as it rose over long periods of time. These cracks allowed the Colorado River to flow through the Kaibab Plateau and carve the Grand Canyon.³²

Samuel Franklin Emmons (1897). To form the Grand Canyon, either the Colorado River cut down through the land below, or the land below rose up and was cut by the river. Powell maintained the latter, but he misread specific geologic features. Emmons refuted Powell's explanation,³³ and maintained that the river carved the Grand Canyon by cutting down through the land, a process called *superposition*.

Eliot Blackwelder (1934). Up until 1.8-million years ago, the Colorado River did not exist. Then, as the Rocky Mountains rose their last mile or so, they intercepted more moisture from westerly winds. Rivers flowing down the western slopes of the Rockies became longer and more powerful. River drainage into basins west of the Rockies increased, while the cold, ice age climate reduced evaporation. Therefore, western lakes grew and sometimes breached their banks, carving canyons down to the next lower lake. Eventually, the Grand Canyon was carved and the Colorado River flowed as it does today.³⁴

Edwin D. McKee (1964). The early Colorado River flowed into the Gulf of Mexico along a path that began east of the Kaibab Plateau, then continued along the valley of the Little Colorado River, and finally flowed into the Rio Grande. During the next 8,000,000 years, the Colorado Plateau rose and some streams flowed westward off the Colorado Plateau. One stream eroded headward (upstream) 300 miles northward from the Gulf of California, then 130 miles eastward through the Kaibab Plateau. The stream eventually captured the waters of the Colorado

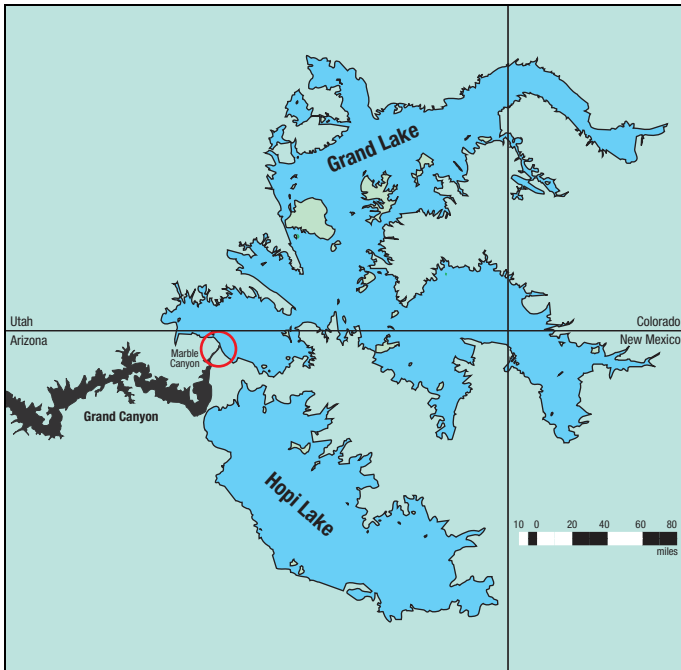

Figure 124: Grand and Hopi Lakes. The funnel region (marked by the red circle) was carved by water suddenly released from Grand Lake. [See Figures 119, 125, 126, and 129 for different perspectives of the funnel.] The region covered by this map lies in the southwest portion of the Colorado Plateau, which has an average elevation of 6,200 feet above sea level and an area the size of Germany or New Mexico.

River, which then changed course and began flowing west, where it eroded the Grand Canyon.³⁵

Charles B. Hunt (1976). The Grand Canyon was carved in segments. First, the eastern part was partially carved both by superposition and by the land rising as the river cut down through it. The river ponded in a large basin north of Kingman, Arizona. Later, that lake tunneled northward through caverns and limestone deposits, exiting as a spring feeding another lake just beyond today's western end of the Grand Canyon. This is how and where the Hualapai Limestone accumulated. When the flow from east of today's Grand Canyon increased, lakes overflowed, cutting the western Grand Canyon. Over the next few million years, the Colorado River cut the canyon to its present depth.³⁶

Ivo Lucchitta (1988). The early Colorado River flowed southwest across a flatter Kaibab Plateau, cutting down through it by superposition. West of that plateau, the river flowed to the northwest. Faulting and volcanism have since erased that path.

About 5-million years ago, a stream began to flow south into the newly opened Gulf of California. That stream eroded headward along what is now the Colorado River's path after it leaves the Grand Canyon. Further headward erosion to the east allowed the stream to intersect and capture, west of the Kaibab Plateau, the Colorado River, which then carved the Grand Canyon.³⁷

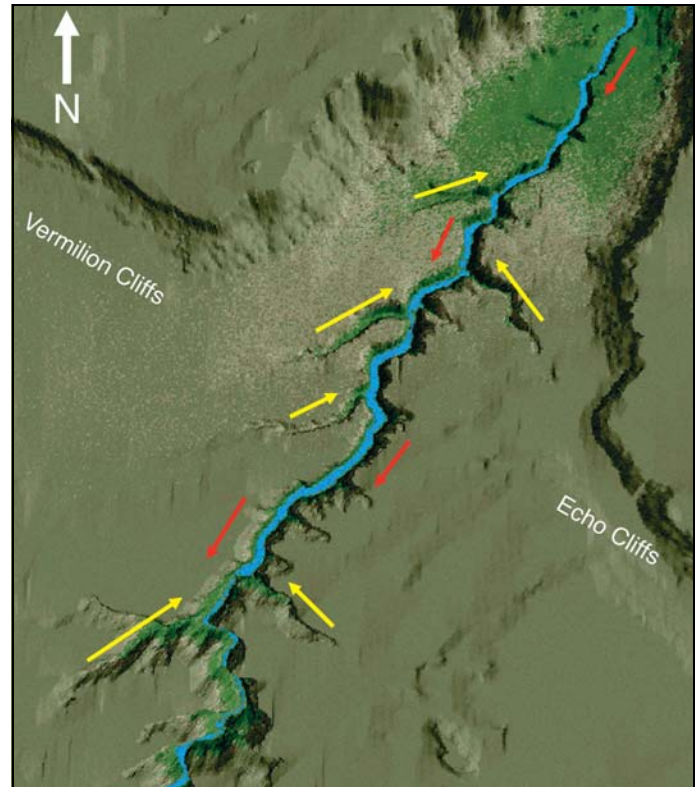

Figure 125: The Funnel and Barbed Canyons. This computer-generated picture resembles a photograph taken from 35,000 feet above the "barbed" side canyons feeding into the Colorado River. (The diagnostic importance of barbed canyons will soon be explained.) Flowing surface and subsurface water carved the barbed canyons in a direction (yellow arrows) opposite to the flow of the Colorado River today (red arrows). Notice that Echo Cliffs and Vermilion Cliffs nearly align. The funnel-shaped opening in the top right corner cut through a single cliff system, giving us these two sets of cliffs today. A giant, high-pressure hose, gushing from the upper right corner in the direction of the red arrows, would carve the funnel nicely.

Norman Meek and John Douglass (2000). About 6,000,000 years ago, the Colorado River drained into Hopi Lake. Eventually, the lake breached, spilling over the Kaibab Plateau to the west. The released water filled other basins downstream, forming lakes that breached successively. The region west of today's Grand Canyon may have subsided by almost one mile, and the Colorado Plateau may have tipped to the southwest, giving the waters from the upper Colorado River enough energy to carve the Grand Canyon.³⁸

Walt Brown (1989)—Hydroplate Theory (summarized on pages 111–151). During the flood, massive amounts of sediments were produced by the high-velocity water escaping from the subterranean chamber. Sediments settling through the waters were then sorted for weeks by liquefaction, forming thin, horizontal layers totaling more than a mile in thickness. By the end of the flood, those water-saturated sediments held about 20% of the flood water. Groundwater that escaped years later sculpted much of earth's terrain.

Near the end of the flood, continent-size hydroplates (still with some lubricating water below) accelerated downhill, away from the rising Mid-Atlantic Ridge and toward the

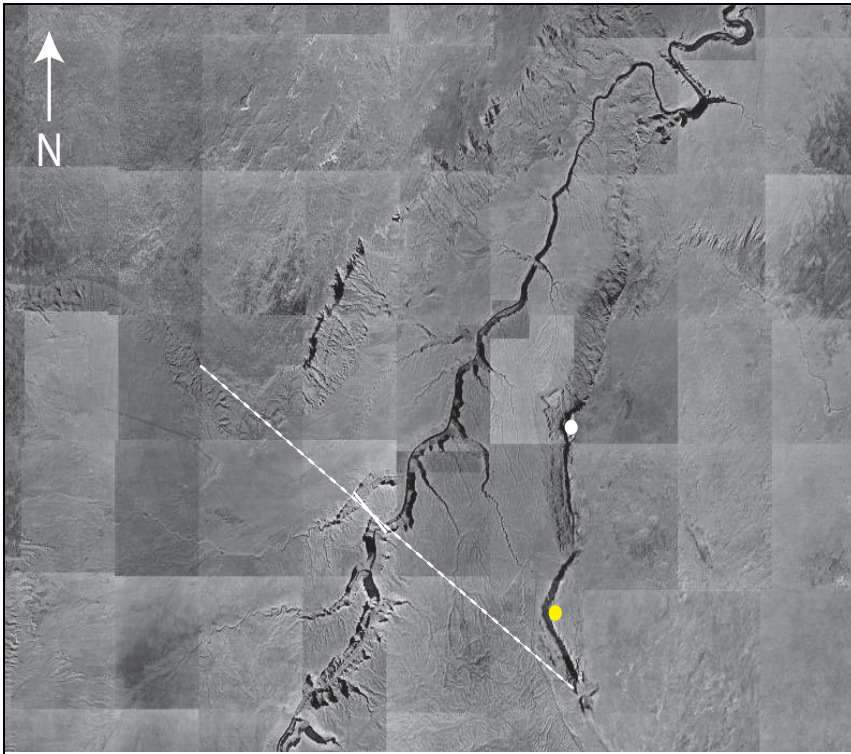

Figure 126: Aerial Photograph of the Funnel and the “backward” Barbed Canyons. The dashed white line shows approximately where Echo-Vermilion Cliffs were connected before Grand Lake breached and the funnel was cut. This was confirmed during my field study by finding a long, vertical fault³⁹ (marked by the solid white line) and shown in Figures 148—149 on page 251.

Notice that this cliff system was parallel to the other northwest-to-southeast cliffs in the Grand Staircase to the north. All were formed as Grand Lake, to the northeast, drained through the funnel. That steady removal of the weight of the lake’s water was equivalent to a growing upward force lifting the bottom of the draining lake and producing a series of shearing failures. Each shearing failure raised one of the steps in the Grand Staircase—including Echo-Vermilion Cliffs.

The higher the southwest facing cliffs (“steps”) in the Grand Staircase were lifted as the Colorado Plateau rose, the more subsurface water spilled out from those cliff faces during the Great Denudation, and the more erosion south-west of each “step.” Figure 140 on page 235 will give you a feel for the massiveness of Grand Lake’s waters. Supporting all of the above are Figures 127 and 128 which show what is found at the yellow and white dots.⁴⁰



Figure 127: Tipped Cliffs (Looking Southward). As Grand Lake breached catastrophically and carved the funnel, so much mass was removed that the land below had to *quickly* bulge upward, including the land below the newly exposed cliffs bordering the funnel.

Why quickly? As you read “**Plateau Uplift**” on page 226, you will see that immediately after the flood, frictional heating from the sinking Rocky Mountains began producing magma. That liquid, injected between the former floor and roof of the subterranean chamber, lifted the Colorado Plateau. Therefore, for every ton of rock and water removed by the breaching of Grand and Hopi Lakes, a ton of liquid magma immediately shifted directly below the eroded region in order to maintain vertical force equilibrium. This is called “the water-balloon effect.”

All 40 miles of surrounding cliffs arched upward toward Marble Canyon (the “Big Crack”), although Marble Canyon is 2–5 miles away. For perspective, note the houses at the base of this portion of Echo Cliffs, marked by the yellow dot in Figure 126. Most rubble (talus) is missing from the base of this 40-mile cliff system, because the water spilling out of Grand Lake and its banks for weeks swept the rubble away and this happened only a few thousand years ago. New rubble has not had time to accumulate.



Figure 128: Potholes. Here, at almost the highest point on Echo Cliffs (the point marked by the white dot in Figure 126), is a weathered pothole.⁴¹ Partially seen at the bottom left and right are two similar potholes. A pothole forms when whirling rocks, caught in an eddy or vortex of a fast-flowing stream, grind down, carving a cylindrical depression.⁴² Why was water flowing so rapidly this high (6,654 feet above sea level) and at the upper edge of a 2,000-foot cliff? (In the extreme top left corner, you can see the edge of the cliff—and far below.)

When Grand Lake breached and began spilling over the Echo-Vermilion Cliff system, marked by the dashed white line in Figure 126, south-flowing water carved these potholes. Within weeks, the miles-wide funnel was carved to the west of these potholes. Had the funnel been a few feet wider at this location, the rock where my geologist friend is standing would have been swept away.

That torrent of water swept at least 2,000 cubic miles of soft Mesozoic sediments were swept off the hard Kaibab Limestone—the great denudation. Days later, as the Grand Canyon began to be carved 30 miles to the south, land under the Grand Canyon steadily rose, lifting the south end of the funnel. This is why the funnel’s floor of hard Kaibab Limestone now rises more than 1,000 feet as one proceeds southward along the top of Marble Canyon. Echo and Vermilion Cliffs. These potholes also rose. All the layers exposed in these cliffs and in the walls of Marble Canyon show this dramatic tipping. [See Figure 127.]



Figure 129: The Big Crack: Where Marble Canyon Began. Water from Grand Lake spilled out near the top right corner of this picture and flowed violently toward the bottom left corner, eroding this funnel-shaped region. As huge amounts of material were removed, the horizontal sedimentary layers below—no longer pressed down by so much weight—arched upward, stretched, and cracked. Subsurface water then began spilling into this deep, minutes-old crack, now called *Marble Canyon*. Notice the many small “sink valleys” and their tiny tributaries near the edge of Marble Canyon. Surface channels that captured a large portion of the water spilling out of Vermilion Cliffs (at the top of the picture) and Echo Cliffs (at the bottom right) grew larger, allowing them to capture even more water. They became barbed canyons. Can you see why they are somewhat evenly spaced along Marble Canyon?

Today, thirty miles to the south, Marble Canyon joins the Grand Canyon where the Little Colorado River enters the Colorado River. [See Figure 119.] Vermilion Cliffs and Echo Cliffs were previously joined, but today mark the funnel’s western and eastern boundaries. From nearby Highway 89A, that extends into the funnel in the shape of a hairpin and crosses the Colorado River at Navajo Bridge, the upward arching layers in these cliffs are easily seen. [See Figure 127.]

sinking Pacific plate. Within hours, the hydroplates met resistances and crashed. This *compression event* crushed, thickened, and buckled the hydroplates, quickly pushing up Earth’s major mountain ranges. (To see how quickly, read pages 486–487, and don’t be shocked. Just follow the evidence.) For other details, see pages 111–151 and 195–213.

A series of major events then occurred which produced the Grand Canyon.

- The flood waters drained off the suddenly thickened and elevated continents, leaving behind postflood lakes in every continental basin.
- As the newly formed Rocky Mountains settled into the mantle, they hydraulically lifted the Colorado Plateau an average of 6,200 feet. (This will soon be

explained.) Carried on top were two large, *growing* lakes—Grand Lake and Hopi Lake.

- A few centuries later, Grand Lake breached its southwestern boundary, causing Hopi Lake to also breach. The combined waters of both lakes and the escaping ground water spilled off the western edge of the Colorado Plateau, swept off the soft Mesozoic sediments south and west of the lakes (the Great Denudation), and carved the Grand Canyon in weeks. Therefore, the Colorado River was born—a *consequence, not the cause*, of the carving of the Grand Canyon.
- A few centuries later, Grand Lake breached at its southwestern corner, causing Hopi Lake to also breach. The combined waters of both lakes and the escaping ground water spilled off the western edge of



Figure 130: Inside a Barbed Canyon. Notice the unusual curved layers bending up the sides of North Canyon, a barbed canyon that enters the Colorado River flowing south inside Marble Canyon, one mile behind my camera. How did these layers form?

As Grand Lake breached, the weight removed by the rapid erosion of the funnel caused the ground below to arch up and crack open, forming Marble Canyon. The vertical crack penetrated a 450-foot layer of water-saturated limestone that lay 500 feet below our feet, releasing its *subsurface* water into Marble Canyon. Some of that limestone dissolved, just as water draining through limestone hollows out caves today. The pliable, uncemented layers above the limestone sank and tipped, forming a sink valley. Torrents of *surface* water then entered that valley, eroded it deeper, and carved, from the surface down, this barbed canyon in weeks. Other barbed canyons formed in a similar way. [See Figure 129.]

the Colorado Plateau, swept off the soft Mesozoic sediments south and west of the lakes (the Great Denudation), and carved the Grand Canyon in weeks. Therefore, the Colorado River was born—a *consequence*, not the *cause*, of the carving of the Grand Canyon.

To understand the Grand Canyon's origin, we must first explain some strange terrain features surrounding the Grand Canyon.

Colorado Plateau. Immediately after the flood, each newly formed mountain range began the slow process of settling into the upper mantle. (Mountains have “roots” that descend into the mantle, a fact known for over a century. The hydroplate theory explains the forces, energy, and mechanism that sank those roots into the mantle and when it happened.) The mass pushed aside by a sinking mountain range increased the mantle's upward pressure next to that range, causing the weakest portion of the crust to break and rise. Thus, plateaus²⁴ rose next to settling mountain ranges. Examples include the Columbia Plateau next to the Cascades, the Tibetan Plateau (the largest, highest plateau in the world) next to the Himalayan Mountains (the most massive and highest mountain range in the world), and, pertinent to the origin of the Grand Canyon, the Colorado Plateau next to the Rocky Mountains. These uplifts were accompanied by considerable faulting and extreme frictional heating. As a result, melting and volcanic activity occurred within each plateau. Large blocks, when lifted and tilted, became cliffs and mountains—called *block-faulted mountains*. North of the Grand Canyon are many examples: Utah's Book Cliffs, Roan Cliffs, the Grand Staircase (Pink Cliffs, White Cliffs, Chocolate Cliffs, Vermilion Cliffs, Gray Cliffs), and others. As the flood waters drained, continental basins became postflood lakes; some quite large.

The Funnel. Imagine a postflood lake with twice the volume of Lake Michigan, 5,700 feet above today's sea level, high on the Colorado Plateau. We will call this lake

Grand Lake. About 15–20 miles southwest of Grand Lake is the top of the long Echo-Vermilion Cliff. Drainage into the lake from higher elevations, and possibly the breaching of higher lakes, increases Grand Lake's depth. Water drains from under Grand Lake, emerging as springs from the face of this 2,000-foot cliff system. Increasingly, the ground sinks along that drainage path between the lake and the cliff. Suddenly, Grand Lake breaches at a point on its bank and catastrophically erodes the soft Mesozoic sediments, forming a gigantic spillway—a steep, 18-mile-long channel shaped like a widening funnel. Within weeks, large volumes of escaping high-velocity water erode the far end of the funnel to 12 miles and a depth of 2,000 feet.

Marble Canyon. The initially horizontal sedimentary layers below the floor of the funnel steadily arch upward as weight is removed by this downward erosion. Eventually, the funnel's floor—hard, brittle Kaibab Limestone—cracks in tension, splitting open the entire floor parallel to the funnel's axis, forming Marble Canyon. [See Figure 129.]

Aquifers (porous, water-saturated, sedimentary layers) cut by this deep vertical crack begin rapidly spilling their waters, like large ruptured water mains, into the newly formed Marble Canyon. Subsurface channels draining into Marble Canyon begin to form. Initially, this underground flow is perpendicular to the canyon walls.

Days later, as more and more mass was removed in carving out the Grand Canyon to the south, the deep layers in the south had to rise. This forced the underground flows near both edges of the newly formed Marble Canyon northward, so they merged with the water spilling out perpendicular to Marble Canyon, forming a hook-shaped (or barbed flow pattern). Directly above these growing underground drainage channels, the earth sank, forming barbed canyons. Instead of sinkholes, we have hundreds of shallow “sink valleys.” [See Figures 129 and 130.] For

Plateau Uplift

Figure 131: Hydraulic Lift. Hydraulic lifts are found in elevators, car jacks, automobile brakes, and mechanisms that launch planes from aircraft carriers. In this schematic of a hydraulic lift, a large downward force or weight (on the right) moves a short distance and lifts a lighter weight (on the left) a long distance. In other hydraulic lifts, a weaker force moving a long distance lifts a heavy object a short distance. The liquids transmitting the force can be water, oil, or, for rising plateaus, magma.

The sinking Rocky Mountains acted as a gigantic force that pushed 2,500,000 cubic miles of magma under the Colorado Plateau, lifting the plateau an average of 6,200 feet above sea level. The world's other plateaus rose in a similar manner—all driven by gravity, beginning immediately after the crashing hydroplates pushed up mountains. Although the roof of the subterranean chamber almost completely collapsed onto its floor by the end of the flood, high-pressure magma easily migrated between those surfaces.⁴³

Sinking of the massive Himalayas pushed about 25,000,000 cubic miles of magma and crushed rocks under Asia's Tibetan Plateau, lifting it 3 miles! To understand why plateaus perplex geologists, see Professor Kennedy's candid statement of the problems on page 119. The hydroplate theory provides a simple explanation.

The Kaibab Plateau is more correctly called the *Kaibab Upwarp*, because its sedimentary layers arch upward.⁴⁴ Its uplift must be seen in the context of the rising of the much larger Colorado Plateau—a true plateau, because its layers are horizontal.²⁴ [See the italicized definition of a plateau on page 220.] Likewise, the rising Colorado Plateau must be seen in the context of the slow settling of the much heavier Rocky Mountains, which had been rapidly buckled upward during the compression event near the end of the flood. (Pages 111–151 summarize the hydroplate theory.)

As the Rocky Mountains slowly settled into the upper mantle, rock below was crushed, melted by sliding friction, and injected *between the former floor and roof of the subterranean water chamber where resisting forces were weakest*.⁴³ The Colorado Plateau then rose as if it were resting on thousands of hydraulic lifts. Below the earth's surface, that liquid rock (magma) lubricated and swept the flow of crushed and melted rocks away from the flanks of the sinking Rockies.⁴⁵ Each narrow channel of flowing rocks and magma constituted one “hydraulic lift.” Most of the energy expended by the sinking Rockies was ultimately converted into heat and the lifting of the Colorado Plateau.

The Colorado Plateau did not rise as one solid block, because the pressure below grew at different rates at thousands of locations. Whenever the pressure at one location became large enough to fracture the rock above, a sudden *but limited* upward jerk occurred. Each fracture

months, the underground channels, were enlarged by all the sediments removed by the escaping water, so the larger underground “pipes” capture even more water.

Eventually, only a few very large, subsurface drainage channels are spilling out at fairly even intervals along Marble Canyon. Also, water pouring out of the sides of the

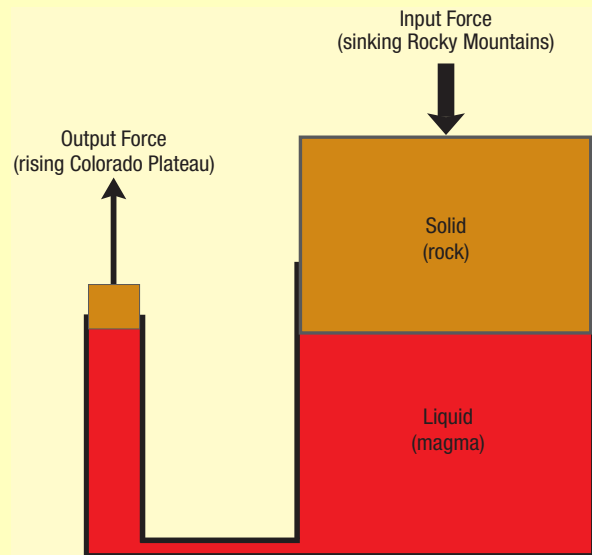

event was *an earthquake*, and each sliding surface was a *fault*. Thousands of faults have been identified and mapped on the Colorado Plateau. Undoubtedly, thousands more are hidden under the soil. Many uplifted and tipped blocks, some hundreds of square miles in area (such as Utah's Grand Staircase), dramatically show what happened.

Why was the uplift limited? Sometimes the irregular sides of a rising block wedged against an adjacent block. In most cases, magma (the “hydraulic fluid”) was not generated fast enough to replace magma losses and to keep the channels (“hydraulic lines”) fully pressurized. For example, some magma escaped into cracks or up to the earth's surface as volcanoes or lava flows. [Page 118 lists some long-standing mysteries concerning “**Volcanoes and Lava**” that the hydroplate theory explains.] Large volcanoes and at least 76 lava flows are in the Grand Canyon area.⁴⁶ Finally, the higher a block rose, the greater the pressure needed to lift it higher. Therefore, the magma below (containing dissolved water⁴⁷) spread laterally, so adjacent blocks which had not risen as much were lifted instead. Spreading magma was like an expanding ink spot. Thus, the Colorado Plateau—and other plateaus—are generally circular.

A block rose when the upward force (produced by the magma's increasing pressure below that block) exceeded the total downward force (the block's weight plus resisting stresses and friction). Both the upward force and the downward resisting forces usually grew in unison—were balanced—so there was no upward movement. But the

funnel spills into some sink valleys more than others, eroding and deepening them, so they capture more surface water and erode even deeper. [See Figures 129 and 130.]

Grand Canyon. The south-flowing torrent of water spilling from Grand Lake undercuts the northwestern corner of Hopi Lake (elevation 5,950 feet), releasing its waters as well.



Figure 132: What Upwarped the Kaibab Plateau? Most of us have squeezed balloons filled with water and watched the least-compressed sides bulge outward. Magma produced by the sinking Rockies was injected under the adjacent crust—specifically along the thin, preexisting channel between what was the subterranean chamber’s floor and ceiling. That magma acted as the compressed liquid in our balloon. Water erosion and water drainage removed weight in certain locations on the Colorado Plateau, so the magma’s pressure directly below those regions dropped. This allowed more magma to flow in and rapidly bulge the crust upward to produce more water erosion and drainage and such features as the Kaibab Upwarp.

This water-balloon effect also accounts for the dramatic upwarping of the crust under what is now Marble Canyon and Grand Canyon as sediments were eroded following the breaching of Grand and Hopi Lakes. These upwarping consequences are seen in Figure 127 on page 223, Figure 129 on page 224, Figures 121 and 122 on pages 218 and 219, and Figure 148 on page 251. Upwarping by the water-balloon effect also produced many deep vertical cracks that grew from the earth’s surface down through water-saturated sediments, opening channels for water to escape and weight removed from what would become the rising Kaibab Plateau.⁴⁴

Geological explanations often lack a clear identification of the forces, energy, and mechanisms. (Obviously, “millions of years” is not an explanation or mechanism.) The mechanism that produced the Kaibab Upwarp was the water-balloon effect. Can you identify the forces and energy?

instant either the resisting stresses or friction reached a breaking point, a small movement occurred. Equilibrium was quickly restored, because the hydraulic pressure below suddenly dropped with each upward jerk. (The Rocky Mountains were higher than the Colorado Plateau, so the pressure under each block tended to increase.)⁴⁸

Their combined waters, now sweeping westward over northern Arizona, first remove at least 1,000 feet of the soft Mesozoic sediments above the hard Kaibab Limestone. As this weight is removed from almost 10,000 square miles south and west of the funnel, deeper sedimentary layers arch upward, stretching and in many places cracking open the hard, brittle Kaibab Limestone above.

Directly west of the breach at “Hopi Falls,” rock was eroded and weight was removed so rapidly that for days the upward forces exceeded the downward forces. The faster blocks rose along that downstream path, the more their tops were eroded and swept away by the violent waters spilling out of Grand and Hopi Lakes. Therefore, these vertical imbalances became even larger, deeper, and broader, resulting in the rapid upward arching of the Kaibab Upwarp—via the water-balloon effect—long after the slow hydraulic uplift of horizontal layers in the entire Colorado Plateau.⁴⁴

Farther downstream, blocks rose and were eroded along a wider path as a huge volume of subsurface water from the flanks of the deepening, 216-mile-long Grand Canyon escaped into the flow. The broad uplift increased, so directly below, *basement rocks* arched upward and cracked in tension, forming the Grand Canyon’s steep-walled inner gorge. [See Figure 70 on page 135 and Figure 122 on page 219.] This is a long-overlooked geological phenomenon: high-velocity water removing massive amounts of overlying material, so the underlying rock arches upward and cracks. [For other examples, see Endnote 76 on page 146, and Figures 63, 65, 66, and 142 on pages 130, 131, 132, and 238.]

After the inner gorge cracked open, the water-saturated, flood-deposited layers above that crack were easily attacked and undercut from below by the eroding torrent widening the canyon. As weight was removed, hydraulic lifting became easier. Below that 216-mile path, blocks fractured as they were forced up, producing dozens of faults perpendicular to today’s Colorado River.²¹ These faults (often more than 50 miles long) provided deep, initially narrow channels for transporting subsurface water down into the main flow that carved the Grand Canyon. The 60-mile-long Bright Angel Fault⁴⁹ allowed easy construction of the popular Bright Angel Trail.

Vast amounts of water, mixed with the flood-deposited sediments, rested on the rising Colorado Plateau. About 20% (or 30,000 cubic miles) of that sediment-water mixture was water—a hundred times the volume of all of earth’s rivers! That water escaped from the periphery of the rising plateau, along dozens of paths. It was similar to water draining from a thick, flat sponge as it is lifted out of a lake. As more subsurface water escaped, those underground channels widened, accelerating the process and producing such spectacular sites as Zion and Bryce National Parks in Utah and Oak Creek Canyon in Arizona. Loss of internal water lightened the plateau, making its hydraulic lifting easier.

Near the breach point on Hopi Lake’s high shoreline, a waterfall, about thirteen times higher (with possibly a hundred times greater flow volume) than Niagara Falls bursts forth. The torrent from “Hopi Falls” plus the flow from Grand Lake sweeps away so much rock that deeper rock must rise—not just directly under the deepening channel, but under the flanks of the channel as well.

[Figures 63 and 66 on pages 130 and 132 explain this well-understood engineering phenomenon—the buckling of a plate on an elastic foundation.] The faster rock rises into the torrent, the more mass the combined flows sweep away, so deeper rock—and *the flanks of the channel*—also rise. A similar mass removal and lifting of the flanks take place along the southern flow inside Marble Canyon. This is clearly seen in the steeply tipped layers in Echo and Vermilion Cliffs, all along Marble Canyon. [See Figure 127 on page 223.] Therefore, the Kaibab Plateau is pushed up by the combined lifts west of the southern flow and north of the western flow. This channels and focuses the western flow through the lowest path, so even more mass is swept away. (Recall that the Mesozoic layers had been swept off days or weeks earlier.) Blocks of rock breaking loose and rising from so many different places under the Kaibab Plateau accounts for its steep, unusually hilly topography. For further insight into why the Kaibab Plateau rose and bulged upward, please study Endnote 44 and Figure 150 on page 253.

About 20% of the volume of sediments on the rapidly rising Kaibab Plateau is subsurface water. The higher the plateau rises, the greater the water's energy and eroding potential. For weeks, landslides, slumps, and mudflows spill down the rising slopes of the Kaibab Plateau from multiple directions. Powerful springs are released around the base and sides of the plateau; many will flow without major seasonal variations for centuries, making Nankoweap [Figure 120 on page 217] an excellent habitat for humans for decades. Some drainage carves deep channels around Nankoweap Mesa, which is topped with earlier slumps, landslides, and rockfalls. Other springs carve Nankoweap Canyon, cutting through thick mud and slump deposits, exposing boulders stacked up to 200 feet high along Nankoweap Creek. Rocks, mud, and water spilling eastward off the Kaibab plateau can go no farther than Marble Canyon, which acts as a gutter, channeling and intensifying the southward flow. Thus, the land east of Marble Canyon is shielded from spillage off the higher, rising Kaibab Plateau.

Meanwhile, cascading waters from Grand and Hopi Lakes have begun eroding a 216-mile path to—and down through—the western edge of the Colorado Plateau. The deeper the waters cut below the high postflood water table, the more high-pressure water is released from the flanks of the lengthening channel. Each sedimentary particle becomes a cutting tool carried by the rapidly-flowing (and falling) water. As more sediments are eroded, more “liquid sandpaper” becomes available to erode more sediments. Additional energy is provided by the release of this mile-high, *subsurface* water. *In weeks, 800 cubic miles of sediments from the Kaibab Limestone and below are removed, forming the Grand Canyon.*

Although Marble Canyon adjoins the Grand Canyon, their different shapes and widths earned them different names.

The canyons' differences are explained when one realizes that the change occurs where the northwest corner of the higher Hopi Lake was undercut by the rushing waters from Grand Lake—where the Little Colorado River now joins the Colorado River. Simply stated, the waters of Grand Lake helped carve Marble Canyon; the merged waters of both Grand and Hopi Lakes helped carve the Grand Canyon. Today, Grand Lake's basin is drained by the Colorado River and several of its tributaries, and Hopi Lake's basin is drained by the Little Colorado River. Both basins were once filled with silica-rich water that quickly escaped. Supporting evidence—mesas, buttes, spires, petrified forests, extreme meandering rivers, side canyons, and hundreds of huge “pits” excavated by powerful, erupting springs—will now be explained. [Mounds, another category of evidence, are explained on pages 206–208.]

Side Canyons of Marble Canyon and Grand Canyon.

Marble Canyon and Grand Canyon were rapidly cut thousands of feet below the high postflood water table. Subsurface water, some traveling great distances,¹⁵ exited from the flanks of these canyons and may have exceeded the water in both Grand and Hopi Lakes combined. That escaping water cut dozens of large, previously unexplained side canyons that now enter Marble and Grand Canyons *at the level of the Colorado River*. Most of these side canyons have no appreciable water source today. A few are “backward.”

Barbed Canyons. With all this weight quickly removed from the Grand Canyon region, the rock layers below rose, so layers north of the Grand Canyon sloped down to the north. Thus, subsurface water near Marble Canyon (and the sink valleys above) drained northward. Water spilling out of the funnel walls—Vermilion Cliffs on the west and Echo Cliffs on the east—flowed into and deepened the northward-draining sink valleys, giving them the shape of the barbs in barbed wire. Although tributaries almost always enter rivers at acute angles, the barbed canyons are oriented at obtuse angles to the Colorado River; they are “backward.” Some barbed canyons are huge—a mile wide and 1,700 feet deep where they enter Marble Canyon.

Side Canyons into Grand and Hopi Basins. Grand and Hopi Lakes emptied in weeks, so the water tables surrounding their basins quickly found themselves hundreds of feet above the dropping lake levels. Perhaps several Great-Lakes' worth of high-pressure subsurface water began seeking underground escape routes into those draining basins. Escaping groundwater exploited faults formed during the uplift of the Colorado Plateau and other underground channels many miles long. Those channels became destinations for even more escaping groundwater. The more water that flowed through these underground channels and their tributaries, the larger they became. In this way, hundreds of canyons formed that today enter the basins of the former Grand and Hopi Lakes.

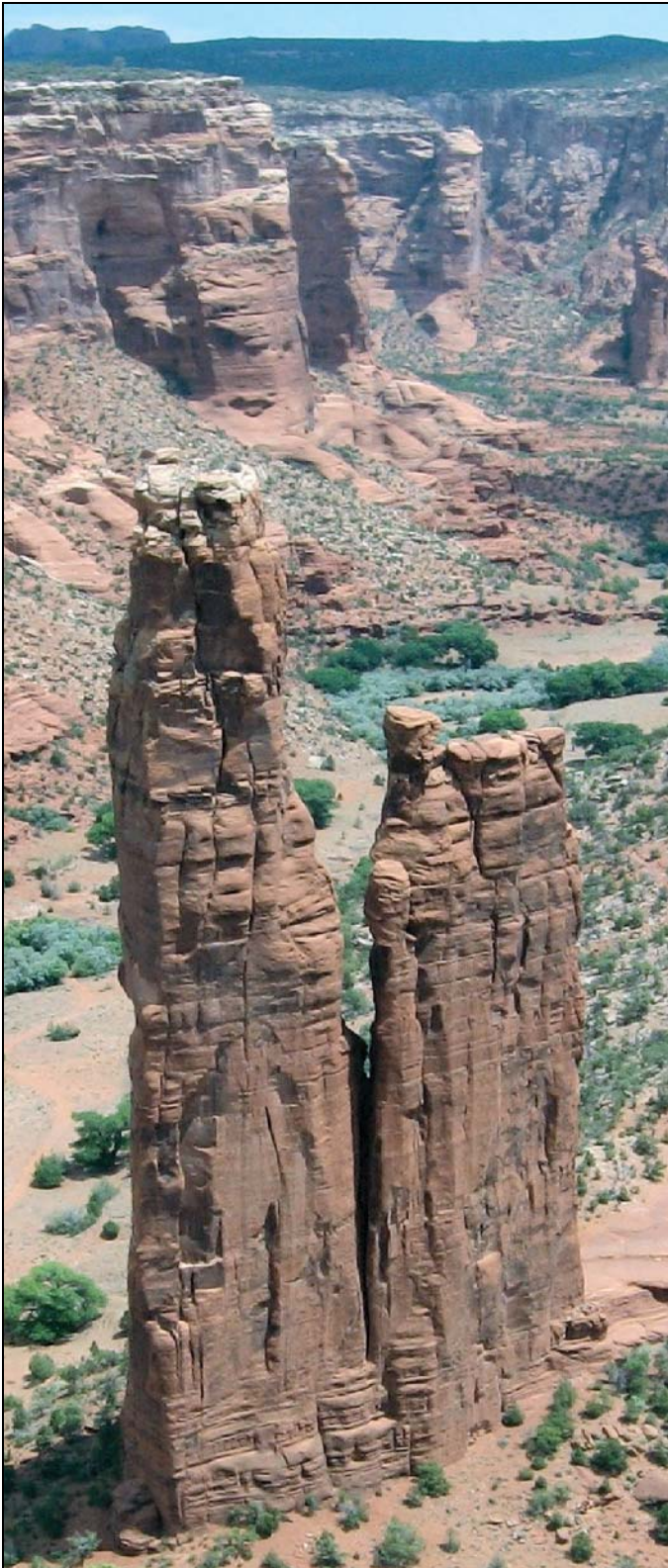

Figure 133: Spider Rock in Canyon de Chelly. Five side canyons (not shown) converge on this 800-foot spire: from the north, northeast, east, southeast, and south. It is hard to imagine terrain that would allow five *surface* streams (which always flow downhill) to carve canyons that converge at the same point from such different directions. However, *subsurface* flow, (which is always in the direction of decreasing pressure), can produce this effect. Obviously, Spider Rock was cemented before the water that carved these canyons swept through this location.

One of the most picturesque is Canyon de Chelly (de-SHAY), a group of canyons up to 25 miles long that radiate east of Chinle, Arizona. Canyon de Chelly enters Grand Lake's basin from the east, near its southernmost location in Arizona. [See Figure 119 on page 214.] Streams and rivers produce canyons with V-shaped cross-sections, but most of Canyon de Chelly has a U-shaped cross-section. U-shaped cross-sections are produced by glaciers or by groundwater flowing out from and undercutting canyon walls. Because no other glacial characteristics are found with

in 500 miles, subsurface flow—not glaciers—probably carved Canyon de Chelly.

Also, Canyon de Chelly has abundant rock debris at the base of its upstream walls but little debris at the downstream end, because only the downstream end was swept by the force of *all the water* flowing out from the walls along the canyon. Relatively little high-velocity water would have passed through the canyon's upstream portions. Subsurface flow is also inferred at a few points on the south rim of Canyon de Chelly where side canyons begin at ridge lines.⁵⁰ (Little *surface* water flows from a ridge line, but much *subsurface* water can flow from beneath a ridge line.)

Mesas, Buttes, and Spires. No land features symbolize the American Southwest more than mesas, buttes, and spires. [See Figure 134.] A *mesa*, which means *table* in Spanish, is a flat-topped feature (with vertical walls formed by erosion) which rises above the surrounding terrain. A mesa is wider than it is tall.⁵¹ A *butte* is similar, but it is taller than it is wide. A very slender butte is a *spire*.

The towering walls of these formations are strikingly vertical. How and when did they form? Two dramatically different explanations are proposed—one requires millions of years; the other only several weeks.⁵² Why are buttes and spires concentrated in Grand Lake's basin? There, adjacent buttes contain corresponding horizontal layers at the same level, showing that they were once connected. What removed the huge volume of sediments between the buttes, and where did the sediments go? Butte perimeters are not streamlined, but scalloped and irregular, so streams did not carve them. (Besides, rivers and streams do not meander enough or flow in circles—a necessary first step if rivers carved buttes.) Nor did wind carve these features, because large, nearby sand dunes are missing. What happened?

Beneath Grand Lake's basin today is a 1,400-foot-thick layer of sandstone. When Grand Lake was present, that sand was uncemented and saturated with water. Because sand grains are hard and somewhat rounded, water-saturated sand layers contain up to 40% water by volume. As the lake emptied, the relatively large channels between these grains allowed the high-pressure water under Grand Lake to discharge rapidly upward, through the lowest portions of the lake bottom—the easiest routes



Figure 134: Monument Valley: Part of the basin that held Grand Lake. On the Arizona-Utah border is Monument Valley, the world's most famous location for mesas, buttes, and spires—and a frequent setting for Hollywood's western movies. These features, and Grand Lake extended thousands of square miles beyond Monument Valley. Grand Lake existed for at least a few centuries after the flood. The long cliff spanning the horizon marks a small part of Grand Lake's boundary. As Grand Lake spilled and began carving the Grand Canyon 100–250 miles to the southwest of Monument Valley, groundwater, no longer trapped under the lake, surged upward through the lower portions of the lake floor and carried off the material that connected these stark and magnificent land forms. All were carved in weeks. Since Grand Lake drained a few thousand years ago, weathering has produced the piles of debris at the base of each mesa, butte, and spire.

of escape. With those upward torrents of high-pressure water came a mix of swirling sand and dirt that was quickly swept out of Grand Lake and down through the Grand Canyon, which was forming 100–250 miles to the southwest. The highest portions of the lake bottom, including islands, offered the greatest resistance to the upward-surging flow, so those high regions remained intact. Cliffs (along some lake boundaries) and mesas and buttes (internal to the lake) began to take shape.

Imagine sitting on the bottom of a shallow swimming pool. Your head barely sticks out of the water and, therefore, is an island. You exert little pressure on the bottom of the pool, because your body is buoyed up by the surrounding water pressure. You almost float. (Such buoyancy is commonly called *Archimedes' principle*.) Suddenly, someone pulls the plug, and the pool rapidly drains; now your entire weight presses against the floor of the pool. Had you been a newly forming butte resting on the floor of the rapidly draining Grand Lake, you would quickly press down on

1,400 feet of water-saturated sediments. It would be as if a 250,000,000-ton rock, with only a $\frac{1}{4}$ -square-mile base, slowly settled down on a water-saturated, 1,400-foot-thick sponge. Water would surge upward and erode the sides of the rock, making the butte slender, its perimeter scalloped, and its walls vertical. The banks of Grand Lake, now quite high, would also increase the pressure on the 1,400 feet of water directly below. If that water could escape upward, a bank segment would become a cliff. This is why few mesas and buttes formed beyond Grand Lake as the flood waters drained from the Earth.

Petrified Forest. Probably the world's largest concentration of petrified wood is in the Petrified Forest National Park in Arizona. (Trainloads of petrified wood were removed before the region became a protected park in 1906.) Few people realize that this park lies inside the former Hopi Lake. Why does wood petrify, how were these unusual conditions met in Hopi Lake, and why is so much petrified wood in the basin of the former Hopi Lake?



Figure 135: Broken Logs in Arizona's Petrified Forest. For a log to snap this cleanly, it must be brittle, as a petrified log would be. To petrify, a log must be saturated with a silica-rich solution, probably in a lake. Then, the silica must come out of solution, which requires the water to cool. A petrifying log (as it gains the added weight of these minerals) would settle gently onto the lake's floor and not break. Because this log broke into many similar-length (but reoriented) pieces, the entire petrified log probably received a powerful impact. How?

A heavy, petrified log lying on a lake floor seems unlikely to break into many pieces that are later reoriented. However, if the boundary of a large lake breached, as in the collapse of a dam, the water would rush out in a torrent, carrying even sunken petrified logs for some distance. A rapidly moving, brittle, petrified log "crashing" back onto the lake bottom would break up, much as an aircraft crashing in a field.



Figure 136: Petrified Wood on a Butte (Shinumo Altar). Obviously, tons of petrified wood did not wash up onto the top of this 500-foot-high butte. Nor is there reason to believe that a major lake, with silica-rich water and floating logs, was once on the very flat top of this butte. Instead, water from the breaching of Grand Lake (11 miles to the north) transported petrified logs to this spot, and then the material around the butte was removed. About 17 miles to the south, the escaping water undercut the northwestern corner of Hopi Lake. Surging waters from both lakes rapidly carved the Grand Canyon.

Wood petrifies when (1) mineral-rich water saturates wood, and (2) some of those dissolved minerals precipitate into the tiniest voids in the wood's cells.⁵³ Usually the water is rich in silica (SiO_2), which forms quartz when it comes out of solution. (The solubility of quartz in water

increases enormously as the water's temperature rises. Conversely, as the water cools, silica is forced out of a saturated solution⁵⁴ and becomes quartz.⁵⁵)

Today, a log floating in a lake will not petrify, but will eventually disintegrate. To petrify a log, considerable silica must be dissolved in water that saturates the log, and that silica must come out of solution before the log disintegrates. (Some petrified wood shows intricate cellular detail, indicating rapid petrification *before* the wood had time to decay.⁵⁶) Silica comes out of a saturated solution that cools, but today's lakes are already cool, so they contain little dissolved silica. How, then, did petrification occur?

Consider the extremely hot, high-pressure water in the subterranean chamber before the flood. [See page 126 for information on supercritical water.] The chamber's roof and pillars were granite. About 27% of granite's volume is quartz. Quartz in contact with hot, high-pressure water quickly dissolves.⁵⁷ Although the temperature of the supercritical waters dropped rapidly as they rose, expanded, and spilled onto the Earth, those flood waters, *supersaturated*⁵⁸ with silica, were still warm. Therefore, floating logs in postflood lakes could easily petrify as temperatures dropped. That occurred in the former Hopi Lake, as seen in today's Petrified Forest National Park.

Researchers using silica-rich solutions have duplicated petrification in laboratories. If we did not realize (1) all the silica that was dissolved in the hot subterranean water and, (2) the role played by large *preflood* trees⁵⁹ floating in warm *postflood* lakes, petrification would be a mystery hidden behind supposed "millions of years."



Figure 137: Goosenecks. One of the world's most famous meandering rivers or streams is the San Juan River, which flows entirely within the basin of the former Grand Lake. Here, near the town of Mexican Hat, Utah, is a section of the river, called *Goosenecks*, where the river has cut down through 1,000 feet of sediments and meanders 5 miles over a distance of only one straight mile. Similar meandering extends 11 miles upstream and 11 miles downstream from this location. Is there a reason for such extreme meandering in Grand Lake's basin?

Finally, notice in [Figure 119](#) on [page 214](#) that Petrified Forest National Park lies in the southeastern end of Hopi Lake's basin, where prevailing winds (which are from the west) would have drifted floating logs.⁶⁰ Also, petrified logs lying on the bottom at that east end of the lake would be least disturbed by all the waters spilling out the west end. This accounts for the high concentration of petrified wood in this most famous petrified forest.

Grand Lake's basin also contains Utah's Escalante Petrified Forest and petrified wood along the Green River. Some petrified wood was swept outside a former lake basin. For example, between the points where Grand Lake breached

and Hopi Lake breached is Shinumo Altar, a 500-foot-high butte capped by hard rock.⁶¹ Petrified wood is scattered over its flat top. (Nearby residents report that petrified logs 7–10 feet long were once on the butte, but a helicopter removed them in about 1999.⁶²) As Grand Lake's waters spilled toward Hopi Lake, petrified wood lying on the bottom of Grand Lake was swept onto flat ground that became the top of Shinumo Altar. [See [Figure 136](#) and, on [page 214](#), [Figure 119](#).] Days or weeks later, the butte formed as the cascading water stripped off 500 feet of the surrounding, softer Mesozoic rocks not protected by a hard cap. Pieces of petrified wood are also scattered in Hopi Lake's basin.



Figure 138: California's Imperial Sand Dunes, also called the Algodones (Al-ga-DOE-nez) Sand Dunes. Where did all this clean, pure sand (2.5 cubic miles worth) come from? Why is it here in a 45-mile-long and 5-mile-wide valley?

Meandering Rivers. Several rivers meander dramatically within the basins of the former Grand and Hopi Lakes. Goosenecks State Park, along the San Juan River, contains the western hemisphere's most extreme segment of a meandering river or stream. Why do rivers meander, and what conditions produce such extreme *and deep* meandering in a river that today is so small and sluggish?

A river flows faster on the outside of a bend than on the inside, just as the outside of a merry-go-round travels faster than the inside. The centrifugal force (pushing outward) then raises the water level on the outside of a bend. Therefore, the river's *surface* water flows toward the outside of a bend, and the *bottom* water completes the circulation by flowing toward the inside. So a river flows in a corkscrew (spiral) pattern around a bend.

Sediments eroded by the faster flow, along the outer bank, are transported to and deposited near the inner bank, where the flow is slower and less able to carry sediments. Even on rivers that are initially fairly straight, slight curves expand and meandering increases, if the flow is *fast, high, and steady*.

Meanders occur on broad, flat flood plains. Deep meanders, as seen in Figure 137, require a large flood plain with deep, loose sediments. The flow out of Grand Lake encountered a major bottleneck, slightly downstream from what is now the Goosenecks region. [See Figure 119 on page 214.] This bottleneck slowed the upstream flow, so sediments were dropped, but through the bottleneck the flow was rapid, so sediments were scoured and the channel deepened.

After the lake emptied, *subsurface* water steadily drained into the large San Juan Basin all along its 1,000⁺-mile perimeter, making the San Juan a powerful river for centuries, especially along the steep channel eroded down through the bottleneck and slightly beyond. This steepness, slight headward erosion back through the still loose sediments, and the high volume of water provided the considerable energy needed to excavate the meandering river's outer banks to the extreme extent seen today.

Why did the Goosenecks develop such uniform and symmetrical meanders? Today, rivers are fed primarily by surface flow, so their depths, sediment loads, and volume flow rates are *seasonal*. This produces varying meander patterns. However, the early San Juan was fed largely by *subsurface* water steadily draining during all seasons into the vast San Juan Basin, so centuries of fast, *steady* flow conditions produced uniform, symmetrical meandering patterns.

California's Imperial Sand Dunes. This is one of the largest sand dune complexes in North America, covering 200 square miles and containing about 2.5 cubic miles of sand. It extends 45 miles up the Imperial Valley between Yuma, Arizona and the Salton Sea.

In his geology textbook, Richard Flint estimates that wind slowly blew all that sand in over "at least 160,000 years."⁶³ He does not identify the source of the sand, why wind concentrated it there, or why little dirt was blown in. Others say that an extinct lake they call Lake Cahuilla (ka-WEE-ah) was fed by the Colorado River and provided the sand. Lakes, however, rarely have the energy to break up rock to produce that volume of sand; even if they could, lakes couldn't separate much sand from the mud and clay that is also produced. Here is the explanation:

The sudden breaching of Grand and Hopi Lakes carved the Grand Canyon and gave birth to the Colorado River. A few thousand cubic miles of sand and other sediments were transported south, along the Arizona-California border (the path now occupied by the Colorado River). That surge far into the Gulf of California also flooded the long, Imperial Valley that extends northwest of Yuma. Sediment-laden water quickly filled that valley, because its entire length is about 700 feet lower than the Colorado River as it exits the Grand Canyon, and much of the valley is below today's sea level. Within the turbid flood waters, sand (as opposed to mud and clay) would have quickly settled out. [See Endnote 6 on page 250 to recall how gritty the Colorado River was.] After the crest of the flooding Colorado River passed the southeast end of the Imperial Valley, most of the valley's waters would have drained back into the Colorado River and ultimately into the Gulf of California. Left behind in the valley were large volumes of sand and the Salton Sea, whose surface today is about 220 feet below sea level.



PREDICTION 15: A chemical and isotope analysis of the sand dunes will show that the sand came from the Grand Canyon.

Mud settles slowly out of standing water. Because little mud lies in the dunes area, the valley was probably filled with gritty water only briefly. This is consistent with the few weeks I estimate it took to carve most of the Grand Canyon. Since this flooding, winds concentrated the sands a few miles to the east, along the western side of the Chocolate Mountains, which parallel the Imperial Valley and act as a barrier to the prevailing winds blowing sand eastward.

Question 1: Was the Grand Canyon formed by draining water at the end of the flood?

The list of "Evidence Requiring an Explanation" on page 219 and Figure 123 on page 220 give many reasons the water source could not have been the Colorado River.

Also, a little thought will show that the Grand Canyon was not carved simply by draining surface water at the end of



Figure 139: A Very Deep Pit. Along Grand Lake’s eastern boundary, just east of Rock Point, Arizona, are at least a hundred huge pits. (A 20-story building could be dropped into the one shown above.⁶⁴) These pits have no visible source of water that could have carved them, nor could the terrain direct much surface water to this spot. *If surface water could not have eroded these pits, then subsurface water did.* (The YouTube film clips mentioned on page 195 demonstrate on a small scale how this subsurface water erupted.) My camera is looking over a small portion of Grand Lake’s basin in the distance. Behind me, the land rises steeply to the east, reaching 9,412 feet, 24 miles away. [See Figure 119 on page 214.] As Grand Lake discharged, a huge reservoir of subsurface water, at the prior level of the lake, but just inside the lake’s boundary, erupted as powerful springs into Grand Lake’s draining basin, excavating these pits. Obviously, the lake must have been present for some time to establish the water table far beyond the lake’s shoreline.

the flood. If flood waters draining all over the Earth at the end of the flood carved the Grand Canyon, there should be hundreds of similar huge canyons worldwide. An attempt to show that the canyon formed at the end of the flood produced no evidence (as explained in Endnote 9 on page 562), but the answer to Question 2 below provides evidence that the Grand Canyon was carved in weeks at least a few centuries after the flood.

Deep water draining off a continent after a flood erodes relatively little solid material *per volume of fluid*. Most erosion occurs within the thin boundary layer at the fluid-solid interface. Therefore, a thin, fast, continuous sheet of water spilling downhill from large lakes will transport large volumes of sediments. This accounts for “the Great Denudation” over 10,000 square miles—in the funnel and south and west of the funnel—and the carving of the Grand Canyon. Likewise, 2,000-foot waterfalls spilling from both Grand and Hopi Lakes had great eroding power.

Everyone agrees that water carved the Grand Canyon, but there would be no Grand Canyon if it were not sitting on a mile-high plateau. (Great height gives water the great energy needed to carve and remove so much material.) So,

- a. how and when⁶⁵ was the Colorado Plateau lifted an average of 6,200 feet above today’s sea level, and
- b. how did so much water rise that high?

Today, if all land above sea level were pushed below sea level, so all Earth’s water was raised as far as possible from the center of the Earth, sea level would rise only 800 feet,⁶⁶—not enough to rise to the height of today’s 6,200-foot-high Colorado Plateau. Therefore, (1) draining water after the global flood did not carve the Grand Canyon as

some have claimed, and (2) the Colorado Plateau, which is littered with marine fossils, must have risen by more than a mile **after the Genesis Flood**. (As explained on page 119, plateaus were lifted slowly after the flood by the sinking of major mountain ranges that were suddenly buckled up during the compression event.)

Right after the flood, lakes were much more abundant than today, because continental basins (formed primarily during the compression event) retained much of the draining flood water. Over time, some lakes lost water by evaporation, seepage, or breaching. However, lakes on the upwind side of mountain ranges received much of the heavy, postflood precipitation the mountains intercepted. Lakes also gained water and deepened (even at high elevations) from springs flowing out of mountains and freshly elevated cliffs. [See Endnote 46 on page 213.]

Question 2: When did Grand Lake breach its natural dam?

After the flood, several very time-consuming processes had to occur before Grand Lake breached.

- a. The Rocky Mountains had to sink into the mantle enough to lift the Colorado Plateau 6,200 feet above sea level. This required injecting 2,500,000 cubic miles of rock under the rising plateau—a huge task.) [See Professor Kennedy description on page 119.] Waters on that high plateau then had enough energy to erode at least 2,000 cubic miles of soft Mesozoic rock over almost 10,000 square miles, and to erode another 800 cubic miles to form the Grand Canyon.
- b. Enough time had to pass to cement certain objects exposed to the torrent of water from Grand and Hopi Lakes. Had tall spires, Shinumo Altar, boulders 200 feet above Nankoweap Creek, and thousands of giant



Figure 140: The Basin that Held Grand Lake. Here's where it all began. This is a "smoking gun," showing that this basin, which held Grand Lake, drained rapidly. If a lake evaporates or drains slowly, the bottom sediments are not disturbed. But here in southeastern Utah, at Canyonlands National Park, we see from the many irregular erosion features, that this basin, which was filled to the top of the cliffs you see on the horizon, drained catastrophically. Only by extremely rapid flow of a vast amount of deep water—twice as much water as in Lake Michigan¹—will such extreme erosion occur and sweep all eroded sediments—not just out of our view, but out of the entire basin, which is twenty times larger than what we see in this picture. The sudden breaching of Grand Lake produced those high flow velocities, carved the Grand Canyon, and produced other spectacular scenery in the American southwest—Monument Valley, Canyon de Chelly, and many national parks: Zion, Bryce, Arches, Capitol Reef, Petrified Forest, and Canyonlands. Have you ever wondered why so many national parks are so close to each other—and on or adjacent to the Colorado Plateau? Now you know.

Notice that a single river didn't carve these features, because the eroded channels are not joined in one long meandering path or the branching tributary pattern of rivers. Instead, multiple, fast-flowing currents acted simultaneously—as we would expect right after a natural dam collapsed.

The funnel—a steep, 18-mile-long spillway, through which Grand Lake's water escaped, is 134 miles to the southwest of this location (N 38°23.347', W 109°52.0866'), and in the direction our camera points. From there, the water eroded the northwest corner of Hopi Lake, releasing its waters as well. The combined flows from Grand and Hopi Lakes, plus an immense amount of subsurface water released by the deep erosion of over 300 miles of canyons and side canyons (that were cut through water-saturated sediments laid down during the flood), transported 2,800 cubic miles of sediments far into the Gulf of California.



Figure 141: The Basin that held Hopi Lake. The geologist at the extreme right gives the scale. Several hundred square miles of the lake's floor were eroded and swept away by the rapid drainage following the breaching of Hopi Lake.⁶⁷ (No surface water exists today to do this excavation.) The escaping waters also carved the canyon that today carries the Little Colorado River. The basin's sediments, which contain petrified wood and a thin layer of coal, were then transported through the rapidly forming Grand Canyon, 50–200 miles to the west. The presence of petrified wood shows that as the lake cooled over many years, its silica-rich waters came out of solution and lodged in the tiniest pour spaces of the floating trees soaking in the lake. The famous Petrified Forest National Park also lies in this basin, about 80 miles to the southeast. Can you see why this picture is similar to the top picture?

- caves not been firmly cemented, they would have disintegrated when these lakes discharged. Grand Lake's basin contains hundreds of massive **liquefaction mounds**, explained on page 207. They must also have been firmly cemented when the basin's water spilled out.
- c. Enough time had to pass for the 350-foot-thick layer of Kaibab Limestone to harden in the presence of so much subsurface water, including water in the thick Mesozoic sediments above. (Hardening made the limestone brittle, so it cracked as shown in Figure 129 on page 224. Cementing also allowed the limestone to resist the torrent of water that swept over northern Arizona during "the Great Denudation.") Hardening had to occur before the potholes shown in Figure 128 could form.
 - d. Enough time also had to pass for Hopi Lake to cool and its silica-rich waters to soak into and petrify floating logs. Arizona's world-famous Petrified Forest National Park is in the basin that held Hopi Lake. Some smaller petrified forests are in Grand Lake's basin.
 - e. The production, eruption, and solidification of lava had to occur at a few dozen isolated parts of northern Arizona before Grand and Hopi Lakes breached. Otherwise, the softer rock below those lava flows would have eroded. For example, Red Butte, 16 miles south of Grand Canyon Village, rises 1,000 feet above the surrounding terrain. It was already capped by hardened lava when the torrent of water spilled out of Grand Lake.
 - f. Time was required for animal migration to the Grand Canyon region. Some squirrels probably completed their migration before the canyon formed.⁶⁸
 - g. Three legends of Native American tribes living near the Grand Canyon contain surprising elements consistent with the scientific evidence presented in this chapter concerning the canyon's formation.⁶⁹ This suggests humans were living in the region when the Grand Canyon formed. If so, some length of time was needed for humans to migrate to the Grand Canyon region.
- Therefore, the Grand Canyon probably formed at least a few centuries after the flood.

Question 3: Why do we not see clear shorelines around the boundaries of the former Grand and Hopi Lakes?

Shorelines can be seen at scattered locations around several extinct lakes, such as Lake Bonneville and Lake Missoula, but the situations at these lower lakes were quite different. After the flood, magma injected below *the Colorado Plateau, lifted it and Grand and Hopi Lakes 6,200 feet above today's sea level.* [See Professor Kennedy's description of this injection beginning on page 119.] This altered the shapes of the lake basins—and shifted their shorelines. Shifting shorelines have less time to leave permanent etchings in the rocks at each level. The shifting liquid below tipped the rising plateau in various ways. A tipping of only *one-tenth of one degree* (0.1°) would have shifted shorelines horizontally at Grand Lake and Hopi Lake by an average of several miles.⁷⁰ Multiple tippings about different axes or about an axis far from the lakes' centers

would multiply this effect. *Lake Bonneville and Lake Missoula were not lifted on a plateau by a shifting hydraulic liquid—and, therefore, remained stationary.* Faulting and volcanism among the thousands of uplifted and tipped blocks of the Colorado Plateau further changed shorelines.

Lake Bonneville and Lake Missoula most likely breached centuries after Grand and Hopi Lakes, giving Bonneville and Missoula more time to etch their shorelines. The frequent thunderstorms on the Colorado Plateau would have tended to erase any shoreline markings.

Many large southwest facing cliffs north of Grand and Hopi Lakes were lifted (block faulted) as the Colorado Plateau was uplifted. (For example: Book Cliffs, Roan Cliffs, and the Grand Staircase.) Much subsurface water escaped from these cliff faces and fed into and steadily deepened Grand and Hopi Lakes—as did drainage from higher elevations and heavy postflood rainfall on the upwind side of the Rocky Mountains. Therefore, *lake levels rose and shorelines expanded and shifted for many years after the flood.*

As Grand and Hopi Lakes emptied, subsurface water surrounding their basins automatically became higher relative to the dropping lake levels. Therefore, powerful springs erupted into the draining basins. That water often removed shoreline segments and undercut the basins' steeper slopes, forming cliffs in and around these lakes, and sweeping debris (talus) away. Consequently, many shorelines of Grand and Hopi Lakes are marked—not by small shelves as with Lake Bonneville and Lake Missoula—but by cliffs. Supporting this explanation is Dr. Edmond W. Holroyd's detailed study⁷¹ showing that a remarkable number of cliffs lie on the boundary of Grand Lake.

Travelers driving through or flying over the basins of Grand and Hopi Lakes see land that differs from adjacent terrain. The basins have a smoother texture, lighter color, and sparser vegetation. A frequent comment is, "It looks like a lake bottom." Indeed, Holroyd, using satellite photographs, observed that "the 'lake' outlines surround naturally bright regions of the Colorado Plateau."⁷² Nearby regions at the same elevations, but outside these basins, do not have these "bright" characteristics.



PREDICTION 16: The soil chemistry in the basins that held Grand and Hopi Lakes will be found to be distinctly different from that of their surroundings.

Evaluation of Evidence vs. Proposals

Table 6 summarizes how well each of nine proposals explains the many strange features of the Grand Canyon. Each column corresponds to a proposal, and each row represents evidence requiring an explanation. A green circle means that, in my opinion, the column's proposal reasonably explains that row's diagnostic detail. Yellow and red circles

indicate moderate and serious problems, respectively. Numbers in Table 6 refer to additional information below.

Readers should make their own judgments and independently assess each proposal's plausibility. For example, if you feel that a detail or proposal has been omitted or misstated, modify the table. This approach focuses future discussions on areas of critical disagreement. It also helps keep all details and competing views in mind, encouraging

balance and thoroughness. Sometimes a disagreement over one detail becomes moot when one recognizes other facts that oppose a proposal. Often, when a theory is presented, only the details supporting it and opposing competing views are mentioned. Table 6 contrasts the best-known published proposals with all the "Evidence Requiring an Explanation" beginning on page 219.

Table 6. Evidence vs. Proposals for the Origin of the Grand Canyon

		Proposals								
		Brown (Hydroplate) 1989	Powell 1869	Gilbert 1875	Emmons 1897	Blackwelder 1934	McKee 1964	Hunt 1976	Lucchitta 1978	Meek/ Douglass 2000
Evidence to Be Explained	Layering	● 1	⊗ 18	⊗ 26	⊗ 35	⊗ 43	⊗ 52	⊗ 61	⊗ 70	⊗ 79
	Limestone	● 2	⊗ 18	⊗ 26	⊗ 35	⊗ 43	⊗ 52	⊗ 61	⊗ 70	⊗ 79
	Why Here?	● 3	⊗ 18	⊗ 26	⊗ 35	⊗ 43	⊗ 52	⊗ 61	⊗ 70	● 79
	Why So Relatively Recent?	● 4	● 18	● 26	● 35	● 43	● 52	● 61	● 70	● 79
	Forces, Energy, and Mechanisms	● 3	⊗ 20	⊗ 28	⊗ 37	⊗ 45	⊗ 54	⊗ 63	⊗ 72	⊗ 81
	Marble Canyon	● 5	● 18	● 26	● 35	● 43	● 52	● 61	● 70	● 79
	Side Canyons	● 6	● 19	● 27	● 36	● 44	● 53	● 62	● 71	● 80
	Distant Cavern Connection	● 6	⊗ 18	⊗ 26	⊗ 35	⊗ 43	⊗ 52	⊗ 61	⊗ 70	⊗ 79
	Barbed Canyons	● 7	⊗ 19	⊗ 27	⊗ 36	⊗ 44	⊗ 53	⊗ 62	⊗ 71	⊗ 80
	Slot Canyons	● 8	⊗ 19	⊗ 27	⊗ 36	⊗ 44	⊗ 53	⊗ 62	⊗ 71	⊗ 80
	Missing Mesozoic Rock	● 9	⊗ 22	⊗ 31	⊗ 38	⊗ 46	⊗ 57	⊗ 64	⊗ 74	● 83
	Perpendicular Faults	● 10	● 18	● 26	● 35	● 43	● 52	● 61	● 70	● 79
	Arching	● 10	● 18	● 26	● 35	● 43	● 52	● 61	● 70	● 79
	Inner Gorge	● 10	⊗ 18	⊗ 26	⊗ 35	⊗ 43	⊗ 52	⊗ 61	⊗ 70	⊗ 79
	Missing River	● 11	⊗ 21	⊗ 29	⊗ 39	●	⊗ 55	● 65	⊗ 75	●
	Missing Talus	● 12	● 18	● 26	● 35	● 43	● 52	● 61	● 70	● 79
	Colorado Plateau	● 8	⊗ 18	⊗ 26	⊗ 35	⊗ 43	⊗ 52	⊗ 61	⊗ 70	⊗ 79
	Kaibab Plateau	● 12	●	⊗ 30	●	●	⊗ 56	●	⊗ 73	● 82
	Unusual Erosion	● 13	⊗ 18	⊗ 26	⊗ 35	⊗ 43	⊗ 52	⊗ 61	⊗ 70	⊗ 79
	Nankoweap Canyon	● 13	⊗ 18	⊗ 26	⊗ 35	⊗ 43	⊗ 52	⊗ 61	⊗ 70	⊗ 79
Missing Dirt	● 14	⊗ 21	⊗ 29	⊗ 39	●	●	⊗ 65	⊗ 75	●	
California's Imperial Sand Dunes	● 14	⊗ 21	⊗ 29	⊗ 39	●	●	⊗ 65	⊗ 75	●	
Fossils	● 1	⊗ 23	⊗ 32	⊗ 40	⊗ 47	⊗ 58	⊗ 66	⊗ 76	⊗ 84	
Tipped Layers below Unconformity	● 15	⊗ 24	⊗ 33	⊗ 41	⊗ 48	⊗ 59	⊗ 67	⊗ 77	⊗ 85	
Time or Intensity?	● 16	● 25	● 34	● 42	● 49	● 60	● 68	● 78	● 86	
Other	● 17				● 50–51		⊗ 69		⊗ –	

Key: ● Explained by proposal.
 ● The proposal has moderate problems with this item.
 ⊗ The proposal has serious problems with this item.
 Numbers in this table refer to amplifying information on pages 238–246.

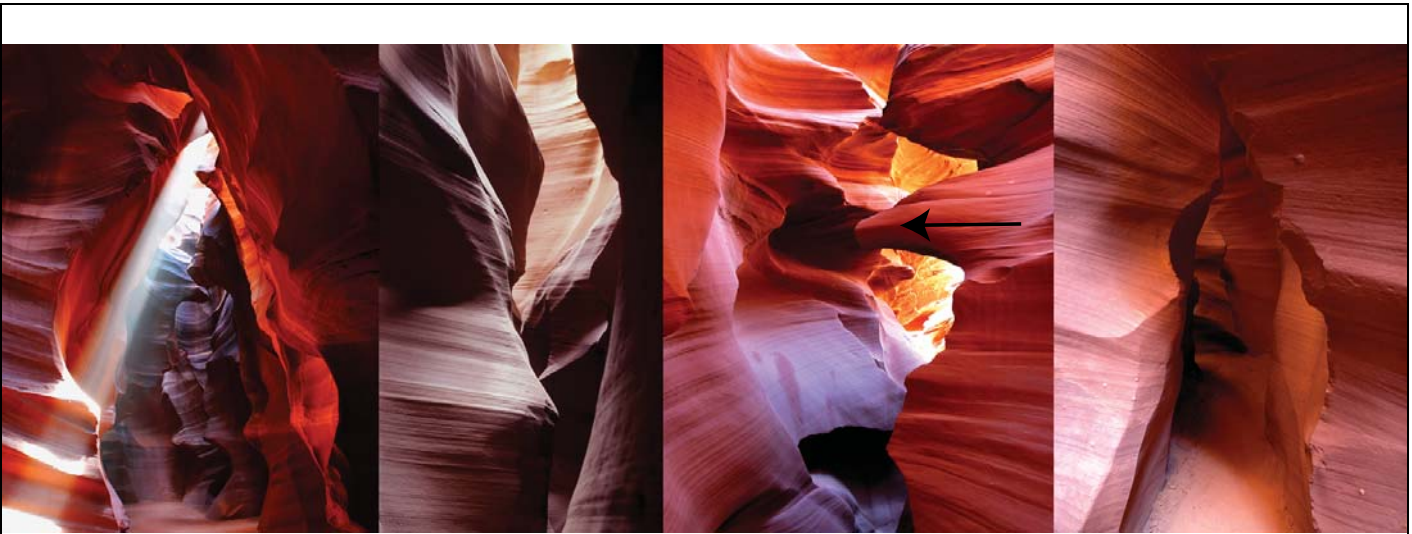

Figure 142: Slot Canyons. Slot canyons have rough, vertical sandstone walls and can be a few hundred feet deep but only a few feet wide. They are usually found on the Colorado Plateau, along tributaries that feed into the Colorado River.⁷³ The above pictures (in true color) were taken in Upper Antelope Canyon, 8 miles southeast of Glen Canyon Dam. Conventional thinking says that slot canyons were carved by streams or flash floods eroding down from the surface. However, that would produce V-shaped canyons with smooth walls, not extremely narrow, vertical canyons with jagged walls (as seen, for example, at the black arrow). Besides, this quarter-mile-long slot canyon (at 36°51'46.14"N, 111°22'30.24"W) cuts through a ridge that rises 120 feet above ground. If the crack were not already there, a stream would flow along or around the ridge, not through it. Also, why would slot canyons be cut primarily through warped sandstone layers on the Colorado Plateau? Why are slot canyons not more uniformly scattered worldwide?

“Plateau Uplift” on page 226 explains why hydraulic uplifting of the Colorado Plateau warped horizontal layers and produced many vertical fractures through those sedimentary layers. After Grand Lake breached, thin, vertical fractures that had penetrated wet layers of porous sand (aquifers) became drainage channels down to what would soon become the Colorado River. Subsurface drainage into and then along those fractures eroded slot canyons and exposed warped, curved layers that were later cemented into sandstone by the silica-rich subsurface water. These vertical fractures produced slot canyons and streams; streams did not produce slot canyons. If all this happened millions of years ago, slot canyons would be much wider and shallower.

Details Relating to Brown’s Proposal (Hydroplate Theory)

1. ● **Layering**, ● **Fossils**. Pages 195–213 explain how the flood produced sharp, parallel, generally uniform sedimentary layers, each with a somewhat unique mineral and fossil content. If the Canyon’s strata formed over millions of years, wind and water would have eroded obvious irregular surfaces between all layers, and the organisms would have decayed or been eaten before they fossilized.

Figure 121 on page 218 accurately shows how cut up the top layer (Kaibab Limestone) is, relative to all the smooth, parallel, generally softer layers below. Despite the hardness of Kaibab Limestone, its exposure to erosion has been much greater than that of the layers below. (Some people mistakenly believe that each of those lower layers were, in turn, top layers subject to erosion for millions of years.)

2. ● **Limestone**. As pages 260–266 explain, way too much limestone exists on Earth to have been produced by processes and chemistry at the Earth’s surface. Almost all limestone came from the subterranean water chamber (including the pure Hualapai Limestone) and was deposited during the flood, before the Grand Canyon formed. Once the Grand Canyon was carved, the Colorado River could flow.

3. ● **Why Here?** ● **Forces, Energy, and Mechanisms**. At the end of the flood, crashing hydroplates pushed up mountains and thickened continents. As the flood waters drained off these continents, basins were left full of water. Therefore, lakes were abundant immediately after the flood. Many breached their banks and carved small canyons. Massive mountain ranges settled into the upper mantle, hydraulically lifting adjacent regions, forming plateaus.



PREDICTION 17: After the flood, the Colorado Plateau was lifted by hydraulic pressure that produced thousands of vertical cracks. Drainage of ground water through those cracks widened the cracks and eroded slot canyons. Therefore, cracks filled with cobbles and sediments will be found miles below the floors of slot canyons.

Atop the rising Colorado Plateau were two very large and growing lakes: Grand Lake and Hopi Lake. They had great potential energy relative to the base of the plateau and, therefore, huge erosion potential. (The higher the water, the greater its potential energy.) That energy was “cashed in” as Grand and Hopi Lakes breached and released their water down the western edge of the mile-high Colorado Plateau. Also released were large volumes of high-pressure subsurface water surrounding Grand and Hopi Lakes and



Figure 143: The Wave. The beauty of this frequently photographed region on the Colorado Plateau (45 miles north of the Grand Canyon at 36°59'35.87"N, 112°00'28.26"W) should not distract us from the obvious question, “*What caused it?*” Rocks don’t bend, but water-saturated sediments deform when confined and subjected to great pressures and powerful movements, as also seen in Figure 50 on page 117.

Recall that the compression event rapidly lifted the Rocky Mountains. The Rockies then began subsiding toward their equilibrium depth. That sinking created hydraulic pressures that lifted the adjacent Colorado Plateau. [See pages 226–227.] Thousand of blocks were fractured and lifted, warping what were initially thin, horizontal, water-saturated layers sorted during the flood, months earlier, by liquefaction. Iron bearing minerals, dissolved and uniformly distributed in portions of those flood waters, give these sediments their red (rusted) color. Similar warped layers (“red waves”) are also seen in slot canyons, which the uplift of the plateau also produced.

the freshly cut canyons. The subsurface water released into the Grand Canyon may have exceeded the water in Grand and Hopi Lakes combined. The resulting 216-mile “erosion gully” extending down through the western edge of the Colorado Plateau is the Grand Canyon.

Although lakes at high altitudes experience high evaporation, the newly formed Rocky Mountains intercepted the moist eastward-moving winds generated by the warm Pacific Ocean, which was heated by extensive flood basalts for centuries after the flood. [See pages 153–192.] This produced considerable precipitation and drainage west of the Rockies, feeding lakes on the western slopes. Spillage from higher elevations also contributed to the final breaching of Grand Lake, which in turn breached Hopi Lake. Surging water from both giant lakes quickly swept off the Mesozoic sediments from at least 10,000 square miles south and west of the funnel.

4. ● Why So “Recently”? Did the Grand Canyon form during the last one-thousandth of Earth’s history? Only if (1) radiometric dating is correct, and (2) the Colorado River carved the canyon. As explained earlier in this book, both ideas are problematic. [See especially “[The Origin of Earth’s Radioactivity](#)” on pages 379–433.] Besides, so many earlier rivers, having more time to flow, should have carved many deeper and longer “Grand Canyons.”

5. ● Marble Canyon. Marble Canyon began as a tension fracture. Therefore, Marble Canyon has narrow vertical walls and follows a fairly straight path. (The Nankowep region, at the southwestern end of Marble Canyon, is an exception that is explained in item 13 below.) Marble Canyon ends where Hopi Lake breached—at “Hopi Falls”—where today the Little Colorado River intersects the Colorado River. Notice in [Figure 120 on page 217](#) that the torrent flowing away from “Hopi Falls” eroded, smoothed, and widened the region just south of the yellow perimeter.

All the thin strata in the walls of Marble Canyon and in Echo and Vermilion Cliffs rise to the south, because so much mass was rapidly removed from the Grand Canyon to the south. Figure 127 on page 223 shows that these strata also rise toward Marble Canyon, because the spillage from Grand Lake stripped off so much mass above and flanking what is now Marble Canyon. Also, Marble Canyon is a deep vertical crack and, thus, a line of bending weakness and uplift. Had these 2,800+ (2,000+ + 800) cubic miles of debris been removed over millions of years, instead of in weeks, the slow buildup of stresses would have been distributed over a wider area, resulting in less dramatically tipped layers.

6. ● Side Canyons, ● Distant Cavern Connection. Subsurface water—released by faulting and the rapid downcutting of Marble Canyon and Grand Canyon far below the high postflood water table—carved dozens of large side canyons. They, in turn, released groundwater on their flanks.

7. ● Barbed Canyons. As thousands of cubic miles of rock were removed from the Grand Canyon area, the land below it rose. That lifting tipped the land around Marble Canyon, so *subsurface* water drained northward (although the Colorado River's flow has always been southward through Marble Canyon). Those subsurface flows then joined the subsurface flow already spilling out of the newly opened walls of Marble Canyon. Naturally, the east wall's water was spilling to the west, and the west wall's water was spilling to the east. Therefore, the generally northward paths of the subsurface flows hook in and enter both sides of Marble Canyon at right angles. With so much material removed by this subsurface flow, the land above those flows sank, becoming barbed canyons, which then captured most of the water spilling out of the walls of Echo and Vermilion Cliffs.

8. ● Slot Canyons and Colorado Plateau. See Figure 142 and "Plateau Uplift" on page 226.

9. ● Missing Mesozoic Rock. Sheet flow from the sudden breaching of Grand and Hopi Lakes could easily sweep 99% of the soft and crumbly Mesozoic sediments (at least 1,000 feet thick) off the hard, flat Kaibab Limestone. On the Colorado Plateau, these sediments are generally missing southwest of Grand Lake's basin and west of Hopi Lake's basin, but almost nowhere else. Millions of years of rainfall and meandering rivers would not do the job and would leave meandering erosion patterns.

10. ● Perpendicular Faults, ● Arching, ● Inner Gorge. With so much material removed by the eroding waters of Grand and Hopi Lakes and by escaping subsurface water, the basement rock, directly below all the flood-deposited sedimentary layers, arched upward and cracked. This opened the deep, steep, narrow, and rough inner gorge of the Grand Canyon, allowing even more erosion and removal of sediments above the crack. Hydraulic pressure, driven by the sinking Rocky Mountains, lifted deep blocks, whose tops were then eroded by the violent

water, thereby continuing the uplift. (These blocks were fractured along the vertical planes of greatest weakness—perpendicular to the 216-mile-long axis of the canyon.)



PREDICTION 18: The inner gorge is a tension crack. Acoustical or seismic instruments should be able to detect this deep V-shaped crack far below the bed of the Colorado River.

The Colorado River seldom turns and follows these faults, because the violent, draining waters had already carved most of its channel down off the western rim of the Colorado Plateau before the faults formed.

11. ● Missing River. There is no evidence for a precanyon Colorado River, because the river never existed before the Grand Canyon was excavated. *The river is a consequence of that excavation, not its cause.*

12. ● Missing Talus, ● Kaibab Plateau. The torrent of water spilling southward from Grand Lake swept away much of the talus that would otherwise be at the base of Echo and Vermilion Cliffs. That torrent undercut Hopi Lake's northwestern boundary, releasing a wide, powerful waterfall. (It was roughly thirteen times higher than Niagara Falls and, for a few weeks, discharged more than a hundred times more water each second than Niagara Falls.) The violent flow of water to the west eroded a path through the rising Kaibab Plateau. [See also Endnote 44 and Figure 150 on page 253.]

John Wesley Powell correctly described this process whereby the river cuts a deep channel as the land rises. However, Powell had no idea why the Kaibab Plateau rose or why it rose so rapidly and contained so much water. Nor did he know about Hopi Lake or the forces, energy, and mechanisms involved. Thus, Powell invoked the standard, but vague, explanation: "millions of years." He did not realize that millions of years of flow would not deepen the river's channel unless the thick layer of large boulders at the bottom of the channel were removed, so the basement rock they rested on could be eroded. That requires a very powerful, sustained flow.

13. ● Unusual Erosion, ● Nankoweap Canyon. Had Nankoweap Canyon and its side canyons (shown in Figure 120 on page 217) been carved by water from one locale, such as a lake, multi-directional erosion would not have occurred. Had rainfall, over long periods of time, provided the water that carved these canyons, the erosion would not have been concentrated in that region of unusual erosion. However, *subsurface water* inside the rapidly rising Kaibab Plateau would drain from many directions, and Marble Canyon would act as a gutter, preventing spillage onto the lower terrain east of Marble Canyon.

The vast volume of subsurface water in the Kaibab Plateau could excavate Nankoweap Canyon and its tributaries, support humans and their agriculture for decades, carve

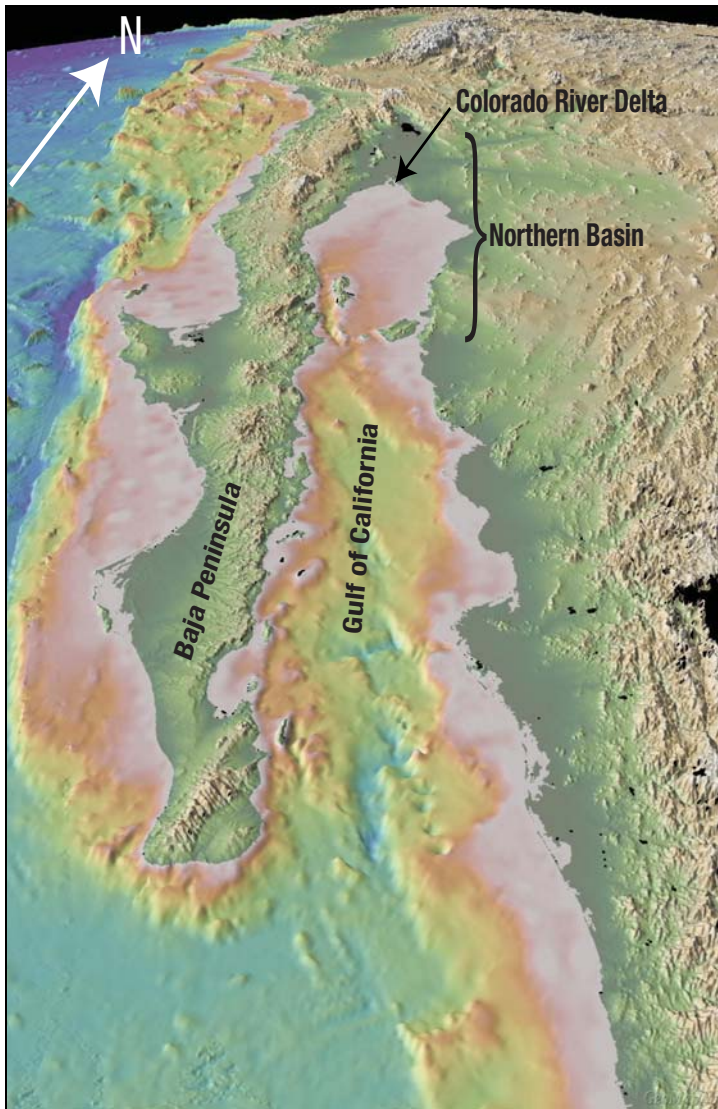

Figure 144: Here's the Dirt. It's right where we would expect it, if we understand the Grand Canyon's rapid and violent formation. Hidden beneath the flat floor of the Gulf of California's Northern Basin are at least 6,000 cubic miles of sediments. That basin, bounded on the south by the largest islands in the Gulf, has an area of 15,000 square miles (220 miles long and 60–100 miles wide). Sediment depths are up to 1.2-miles thick!⁷⁴ About half the basin's sediments were rapidly transported from the Grand Canyon (on the figure's northern horizon), along the path now occupied by the Colorado River.

Why is the Northern Basin's 15,000-square-mile floor so flat? As the Grand Canyon formed a few centuries after the flood, thousands of cubic miles of sediments were swept into the basin within weeks. Larger particles settled out first, near today's shoreline. Finer particles settled out last, but until they did, the muddy water, because it was denser, flowed to the basin's deeper regions where the mud eventually settled—smoothing the seafloor.

At the end of the global flood, draining surface water swept sediments to lower elevations. For years afterward, swollen rivers, flowing down to the lowered sea level, cut channels and small canyons into these deposits. Over the next few centuries, sea level rose and covered some of these channels; today, they are called *submarine canyons*. [For details and evidence, see the Hydroplate Overview chapter that begins on page 111.] The Gulf's submarine canyons that have not been buried in sediments are all in the southern end.⁷⁵ Why? Submarine canyons that were cut into the Northern Basin were buried a few centuries after the flood by sediments swept into that basin when the Grand Canyon formed.

Had the relatively shallow Colorado River—which today flows slowly in its 310-mile southward journey—deposited these sediments over millions of years, we would see a river delta hundreds of miles long rising slightly out of the water. Waves and tides would have formed many fan-shaped channels. The tiny delta that has built up *above sea level since the Grand Canyon formed* is indicated by the tiny dot at the tip of the arrow at the extreme northern end of the Gulf. Only the powerful flow that carved the Grand Canyon could have deposited all the sediments that are far to the south, on the floor of the Gulf.

a channel through thick mud deposits (exposing rounded boulders 200 feet high along Nankoweap Creek), deposit slumps, landslides, and rockfalls on top of what later became Nankoweap Mesa, and create the largest delta within the Grand Canyon. (Because all this happened only a few thousand years ago, the Colorado River has not yet removed Nankoweap Delta.) Humans left Nankoweap Canyon when their water source could no longer support them.

14. ● Missing Dirt. At least 2,000 cubic miles of Mesozoic sediments were stripped off the layers surrounding and above what is now the Grand Canyon. Only then could the 800 cubic miles of sediments be removed from inside the Grand Canyon. There was plenty of water to transport all that dirt downstream from the Grand Canyon, primarily into the northernmost 220 miles of the Gulf of California. [See also “California's Imperial Sand Dunes” on page 233.]

Relatively few sediments were deposited along the Colorado River as it flows south toward the Gulf of California. Rounded boulders mixed with sand and clay are often seen where today's side streams have cut channels 100–200 feet deep. Those rounded boulders show that

they were tumbled and transported by high-velocity water. Unsorted mixtures of sand, clay, and boulders show that the turbulent, muddy water suddenly slowed, dumping the unsorted mixture. [See Figures 145 and 144.]

In 2011, the United States Geological Survey completed a detailed study of the broad, 400-mile-long flood plain between the western end of the Grand Canyon and the Gulf of California. The study concluded that the Colorado River recently had a single, rapid flooding event in which almost all sediments below the flood plain were deposited. [That flooding and gigantic deposition of sand and mud resulted from the breaching of Grand and Hopi Lakes. W.B.]

15. ● Tipped Layers below the Great Unconformity. This tipping is explained on pages 202–207, beginning with the section, “Liquefaction During the Compression Event.”

16. ● Time or Intensity? Intensity: The sudden release of the mile-high water in Grand and Hopi Lakes quickly produced a tremendous amount of erosion, beginning with the Great Denudation. Also, ground water released into



Figure 145: High-Velocity Flow. After the Colorado River exits the Grand Canyon, it turns sharply south and travels 310 miles to the Gulf of California. Much of the land east and west of the river resembles a wide, flat floodplain, but the volume of sediments there falls far short of the 2,800 cubic miles excavated to form the Grand Canyon. Here, south of Bullhead City, Arizona, 1 mile east of the Colorado River and 100 feet above it, are well-rounded boulders whose transport required extremely high-velocity water. (My pencil, in the two insets, provides the scale.) But where is all the dirt?

the Grand Canyon from the water-saturated sediments probably exceeded that of all the lake water. The deeper the erosion, the more subsurface water was released.

17. ● Other. The Colorado River and its tributaries flow through and cut the rims of many basins upstream from the Grand Canyon. This strongly suggests that various upstream lakes breached after the flood waters drained. The breaching of one lake suddenly added water to a lower lake, causing it to breach. Many lakes probably breached sequentially, like falling dominoes. Two of the Colorado Plateau's last big lakes to breach were Grand and Hopi Lakes.

Details Relating to Powell's Proposal

18. ✖ Layering, ✖ Limestone, ✖ Why Here? ● Why So "Recently"? ● Marble Canyon, ✖ Distant Cavern Connection, ● Perpendicular Faults, ● Arching, ✖ Inner Gorge, ● Missing Talus, ✖ Colorado Plateau, ✖ Unusual Erosion, ✖ Nankoweap Canyon, ✖ California's Imperial Sand Dunes. This proposal does not address the obvious questions associated with these aspects of the Grand Canyon and nearby regions. [See "Evidence Requiring an Explanation" beginning on page 219.]

19. ● Side Canyons, ✖ Barbed Canyons, ✖ Slot Canyons. Some believe that sudden storms can produce flash floods that carve new canyons. While flash floods produce considerable erosion in stream channels and *existing* canyons, flash floods would not produce steep and narrow canyons, especially canyons that drain in an opposite direction to the river they feed, as we see in the

gigantic barbed canyons. Slot canyons also have many characteristics that are inconsistent with this explanation. [See Figure 142 on page 238.]

One proposal for the barbed canyons is that the Colorado River flowed north when those canyons were carved. However, this raises other troubling questions: What would tip the Colorado Plateau so the river flows in the opposite direction today? Why would the barbed canyons always "hook in" and enter the Colorado River at almost exactly right angles?

20. ✖ Forces, Energy, and Mechanisms. Powell and most geologists between the mid-1800s and 1960 were misled by a theory proposed by James Dwight Dana in 1847. Dana, a Yale geology professor, said that the Earth contracted as it cooled from its molten state, much like the wrinkled skin of a dried-up apple. Powell thought this accounted for the uplift of the Colorado Plateau and the Kaibab Plateau. A simple calculation would have shown that the thermal contraction of rock is too small to produce mountains or plateaus. ["Molten Earth?" on page 28 and "Forming the Core" on page 160 each explain why the Earth was never molten.]

21. ✖ Missing River, ✖ Missing Dirt. Since 1934, discoveries have shown that the western Grand Canyon and beyond were not cut by the Colorado River.⁸⁻¹¹ Nor does the Colorado River delta contain even 1% of the dirt excavated from the Grand Canyon.

22. ✖ Missing Mesozoic Rock. Millions of years of rainfall and meandering rivers would not sweep 99% of the Mesozoic sediments (at least 1,000 feet thick) off the flat Kaibab Limestone. Besides, why would at least 2,000 cubic miles of Mesozoic rock, spread over 10,000 square miles, be missing around the Grand Canyon—including on top of the high Kaibab Plateau—and yet generally remain elsewhere?

23. ✖ Fossils. This proposal for the Grand Canyon is linked with the bankrupt theory of evolution. Both require hundreds of millions of years. The Great Unconformity is said to mark the time when life began. Fossils are not found below that plane, supposedly because life had not yet evolved. Pages 5–25 and 195–213 give many reasons why this theory is untenable.

Notice that the theory of evolution relies upon many other theories, each proposed in an attempt to solve a large class of problems: how space and matter came into being (such as the big bang theory), how chemical elements formed, how stars, galaxies, Earth, and life began, how *macro*-evolution (not *micro*evolution) happened, why transitional fossils are missing, why vital organs and DNA exist, what produced irreducible complexity, and why, directly above the Great Unconformity, fossils of all animal and plant phyla are suddenly found (the Cambrian explosion). Consequently, each evolutionary link in this assumed chain

of origins—from protons to planets to people—must be established before one can conclude that animals and plants evolved after the Great Unconformity somehow formed. Most proposed explanations for the Grand Canyon accept the evolutionary explanation for fossils and are dependent upon the correctness of all those evolutionary “subtheories.” Part I of this book shows why each is incorrect.

All of this should be contrasted with the hydroplate theory—a single, broad, self-consistent theory that explains the origin of the Grand Canyon and thousands of other pieces of evidence, including layered fossils.

24. ☒ *Tipped Layers below the Great Unconformity.* The uplift of the Colorado Plateau would not tip the thick layers below the Great Unconformity while leaving the layers above horizontal.

An old, now discredited, explanation for the tipped layers was proposed in 1889 by William Morris Davis, head of the geology department at Harvard. Davis said that even mountainous regions eventually erode down to what he called a *peneplain* (meaning “almost a plain”). The Great Unconformity, according to Davis, was such a plain, formed over a vast time period, and the tipped layers below the Great Unconformity were portions of mountains that were not completely eroded. Later, the horizontal layers were deposited, mostly below sea level, and then the Colorado River carved the canyon.

One reason geologists now reject the peneplain concept is that none are seen forming today.⁷⁷ Mountainous regions do not lie below eroding surfaces that are almost plains. Another problem is that the metamorphic rock below the Great Unconformity formed under great pressure. The topic “**Metamorphic Rock**” on page 119 explains why reasonable depths of overlying rock would not provide the pressure required. As explained on page 131, the compression event accounts for the pressure required.

25. ☐ *Time or Intensity?* Time: If the Colorado River, flowing for millions of years carved the Grand Canyon, the river should have produced a gigantic river delta where it enters the Gulf of California. It has not. Nor would surface erosion for millions of years produce the erosion patterns shown in [Figure 121 on page 218](#) and [Figure 123 on page 220](#). Intense subsurface drainage would. Many other rivers have higher velocities and volume flow rates. Why haven’t they carved other Grand Canyons?

Despite being checked and rechecked, the radiometric dating techniques that date the Colorado River, and supposedly justify that much time, give contradictory results.

[Upstream from the Grand Canyon] *the river shows evidence of being somewhere between 20 and 10 million years. How can a river be 20 million years in one location but no more than 6 million years downstream?*⁷⁸

Did the Colorado River follow a different path? For the last 70 years, geologists have been looking for other paths the river could have taken. None have been found.

Radiometric dating of lava flows in the western half of the Grand Canyon also gives inconsistent dates. The potassium-argon method gives drastically different ages from those of the argon-argon method,⁷⁹ and both methods give different ages from those of cosmogenic dating. Statistical errors cannot explain these differences; so, the assumptions behind at least some of these methods must be in error. [See “**Radiometric Dating**” on page 36 for a brief description of these assumptions, and “[The Origin of Earth’s Radioactivity](#)” on pages 379–433.]

Details Relating to Gilbert’s Proposal

26. ☒ *Layering, ☒ Limestone, ☒ Why Here? ☐ Why So “Recently”?* ☐ *Marble Canyon, ☒ Distant Cavern Connection, ☐ Perpendicular Faults, ☐ Arching, ☒ Inner Gorge, ☐ Missing Talus, ☒ Colorado Plateau, ☒ Unusual Erosion, ☒ Nankoweap Canyon.* Same as item 18.

27. ☐ *Side Canyons, ☒ Barbed Canyons, ☒ Slot Canyons.* Same as item 19.

28. ☒ *Forces, Energy, and Mechanisms.* Same as item 20.

29. ☒ *Missing River, ☒ Missing Dirt.* Same as item 21.

30. ☒ *Kaibab Plateau.* No fault has been found that cuts through the Kaibab Plateau along the Colorado River. Faults in that region tend to run north-to-south, usually perpendicular to the river.

Rivers or streams frequently follow faults, but faults are approximately straight lines. The Colorado River curves frequently in its path through the Grand Canyon, so very little of its path is controlled by faults.

31. ☒ *Missing Mesozoic Rock.* Same as item 22.

32. ☒ *Fossils.* Same as item 23.

33. ☒ *Tipped Layers below the Great Unconformity.* Same as item 24.

34. ☐ *Time or Intensity?* Same as item 25.

Details Relating to Emmons’ Proposal

35. ☒ *Layering, ☒ Limestone, ☒ Why Here? ☐ Why So “Recently”?* ☐ *Marble Canyon, ☒ Distant Cavern Connection, ☐ Perpendicular Faults, ☐ Arching, ☒ Inner Gorge, ☐ Missing Talus, ☒ Colorado Plateau, ☒ Unusual Erosion, ☒ Nankoweap Canyon.* Same as item 18.

36. ☐ *Side Canyons, ☒ Barbed Canyons, ☒ Slot Canyons.* Same as item 19.

37. ☒ *Forces, Energy, and Mechanisms.* Same as item 20.

38. ☒ *Missing Mesozoic Rock.* Same as item 22.

39. ☒ *Missing River, ☒ Missing Dirt.* Same as item 21.

40. ✖ **Fossils.** Same as item 23.

41. ✖ **Tipped Layers below the Great Unconformity.** Same as item 24.

42. ● **Time or Intensity?** Same as item 25.

Details Relating to Blackwelder's Proposal

43. ✖ **Layering**, ✖ **Limestone**, ✖ **Why Here?** ● **Why So "Recently"?** ● **Marble Canyon**, ✖ **Distant Cavern Connection**, ● **Perpendicular Faults**, ● **Arching**, ✖ **Inner Gorge**, ● **Missing Talus**, ✖ **Colorado Plateau**, ✖ **Unusual Erosion**, ✖ **Nankoweap Canyon.** Same as item 18.

44. ● **Side Canyons**, ✖ **Barbed Canyons**, ✖ **Slot Canyons.** Same as item 19.

45. ✖ **Forces, Energy, and Mechanisms.** Same as item 20.

46. ✖ **Missing Mesozoic Rock.** Same as item 22.

47. ✖ **Fossils.** Same as item 23.

48. ✖ **Tipped Layers below the Great Unconformity.** Same as item 24.

49. ● **Time or Intensity?** Same as item 25.

50. ● **Other.** Blackwelder did not show where any lakes west of the Rockies were or where they breached.

51. ● **Other.** Without giving an explanation (energy, forces, mechanism), Blackwelder said that the Rocky Mountains rose their last mile 1,800,000 years ago. This conflicts with most other evolutionists who say the Rocky Mountains completed their rise at least 30,000,000 years earlier.

Details Relating to McKee's Proposal

52. ✖ **Layering**, ✖ **Limestone**, ✖ **Why Here?** ● **Why So "Recently"?** ● **Marble Canyon**, ✖ **Distant Cavern Connection**, ● **Perpendicular Faults**, ● **Arching**, ✖ **Inner Gorge**, ● **Missing Talus**, ✖ **Colorado Plateau**, ✖ **Unusual Erosion**, ✖ **Nankoweap Canyon.** Same as item 18.

53. ● **Side Canyons**, ✖ **Barbed Canyons**, ✖ **Slot Canyons.** Same as item 19.

54. ✖ **Forces, Energy, and Mechanisms.** Since 1960, geologists have claimed that plate tectonics provides the forces, energy, and mechanisms that made the Grand Canyon.⁸⁰ Supposedly, a hypothetical subducting plate (named the Farallon plate), which has since vanished, dove from the Pacific Ocean down about 1,000 miles into the mantle and 1,000 miles eastward. These geologists admit that the plate acted differently from any other plate; it supposedly crushed and buckled the Rocky Mountains⁸¹ but only lifted the Colorado Plateau. Never explained is

why the mountains' layers crushed and buckled but an adjacent plateau and its horizontal layers rose.

[Response: *Subduction is a myth.* Table 4 on page 176 summarizes 17 reasons "**Why Plates Have Not Subducted.**" Besides, the very slowly moving plates do not have the energy to lift mountains or plateaus even one inch. See Endnote 45 on page 213.]

55. ✖ **Missing River.** McKee proposed that the early Colorado River flowed southeast along the path now occupied by the Little Colorado River. That would require the river to flow uphill, over the continental divide, to reach the Rio Grande. "Studies along this postulated course have failed to yield any evidence of southeastward drainage."⁸²

Many geologists are not embarrassed to claim, with no supporting evidence, that rivers once flowed in directions that today would be uphill, over mile-high mountains. These geologists simply claim that, with millions of years, things *could have been* different.

*To be sure, today that would be impossible, for the Colorado River would have had to run uphill. But what is now uphill, in a geologic yesterday, may well have been downhill. Even geologists must remind themselves that the present is merely one insignificant moment out of hundreds of millions of years.*⁸³

Outside of geology, certainly in the applied sciences, such wild, unscientific speculation would result in canceled contracts, rejected proposals, disbelief, or laughter.

56. ✖ **Kaibab Plateau.** This proposal also requires a river west of the Grand Canyon to carve eastward (upstream) 130 miles. Supposedly, the river climbed over high cliffs and plateaus by headward erosion and captured the water of the early Colorado River in north-central Arizona. "No one has lived long enough to see even one stream work its way upslope and capture another."⁸⁴

The Grand Wash Cliffs mark the western boundary of the Grand Canyon and the Colorado Plateau. Those 4,000-foot cliffs would have been the first major obstacle if headward erosion occurred. Other canyons cut only slightly into the Grand Wash Cliffs. If headward erosion were so efficient in cutting a path for the Colorado River, it should have been equally efficient for other canyons directly north, because they had similar weather and rocks.⁸⁵

Had 130 miles of headward erosion occurred, the basin that contains the Hualapai Limestone would have been quickly filled with sediments from that excavation. Little room would have remained for depositing limestone.⁸⁶

57. ✖ **Missing Mesozoic Rock.** Same as item 22.

58. ✖ **Fossils.** Same as item 23.

59. ✖ **Tipped Layers below the Great Unconformity.** Same as item 24.

60. ● *Time or Intensity?* Same as item 25.

Details Relating to Hunt's Proposal

61. ✖ *Layering*, ✖ *Limestone*, ✖ *Why Here?* ● *Why So "Recently"?* ● *Marble Canyon*, ✖ *Distant Cavern Connection*, ● *Perpendicular Faults*, ● *Arching*, ✖ *Inner Gorge*, ● *Missing Talus*, ✖ *Colorado Plateau*, ✖ *Unusual Erosion*, ✖ *Nankoweap Canyon*. Same as item 18.

62. ● *Side Canyons*, ✖ *Barbed Canyons*, ✖ *Slot Canyons*. Same as item 19.

63. ✖ *Forces, Energy, and Mechanisms*. Same as item 54.

64. ✖ *Missing Mesozoic Rock*. Same as item 22.

65. ✖ *Missing River, Missing Dirt*. Same as item 21.

Hunt proposed what he admitted was an "outrageous" idea,⁸⁷ namely, that the 650-foot-thick Hualapai Limestone was deposited just outside the western edge of the Grand Canyon by underground drainage from a higher lake far to the south. Why that underground drainage channel did not become clogged with all the sediments entering from the upper lake was never explained. Nor have underground channels been found there, and no evidence has turned up to support Hunt's proposed path for the early Colorado River.⁸⁸

The Hualapai Limestone is found at several locations, not only outside the mouth of the Grand Canyon. Usually, underground drainage occurs along the first path to develop, not on multiple paths to several distant lakes. Also, the Hualapai Limestone occurs in layers that lie at different depths just west of the Grand Canyon, not simply at the top of that section, as Hunt claimed.⁸⁹

66. ✖ *Fossils*. Same as item 23.

67. ✖ *Tipped Layers below the Great Unconformity*. Same as item 24.

68. ● *Time or Intensity?* Same as item 25.

69. ✖ *Other*. Hunt's explanation is based primarily on his claim that the early Colorado River flowed far south of its present course and ponded in a large basin north of Kingman, Arizona. To support this contention, Hunt cited a Ph.D. thesis being written by Richard Young. Young had concluded that the 70-mile-long channel into this lake sloped in a direction that would not have allowed the flow that Hunt wanted. Hunt simply claimed the opposite and cited Young as supporting his view. Young, inexperienced and intimidated by the senior Hunt, admits that he acquiesced and reworded his conclusion in a fuzzy way that let Hunt reach his desired conclusion.⁹⁰ Young has admitted that his true conclusion was "enough to falsify the core of Hunt's theory."⁹¹ Unfortunately, stature and the desire to advance sometimes trump truth.

Details Relating to Lucchitta's Proposal

70. ✖ *Layering*, ✖ *Limestone*, ✖ *Why Here?* ● *Why So "Recently"?* ● *Marble Canyon*, ✖ *Distant Cavern Connection*, ● *Perpendicular Faults*, ● *Arching*, ✖ *Inner Gorge*, ● *Missing Talus*, ✖ *Colorado Plateau*, ✖ *Unusual Erosion*, ✖ *Nankoweap Canyon*. Same as item 18.

71. ● *Side Canyons*, ✖ *Barbed Canyons*, ✖ *Slot Canyons*. Same as item 19.

72. ✖ *Forces, Energy, and Mechanisms*. Same as item 54.

73. ✖ *Kaibab Plateau*. Same as item 56.

74. ✖ *Missing Mesozoic Rock*. Same as item 22.

75. ✖ *Missing River*, ✖ *Missing Dirt*. Same as item 21.

No evidence has been found that the Colorado River flowed to the northwest after crossing the Kaibab Plateau.⁹²

76. ✖ *Fossils*. Same as item 23.

77. ✖ *Tipped Layers below the Great Unconformity*. Same as item 24.

78. ● *Time or Intensity?* Same as item 25.

Details Relating to the Meek/Douglass Proposal

79. ✖ *Layering*, ✖ *Limestone*, ✖ *Why Here?* ● *Why So "Recently"?* ● *Marble Canyon*, ✖ *Distant Cavern Connection*, ● *Perpendicular Faults*, ● *Arching*, ✖ *Inner Gorge*, ● *Missing Talus*, ✖ *Colorado Plateau*, ✖ *Unusual Erosion*, ✖ *Nankoweap Canyon*. Same as item 18.

80. ● *Side Canyons*, ✖ *Barbed Canyons*, ✖ *Slot Canyons*. Same as item 19.

81. ✖ *Forces, Energy, and Mechanisms*. Same as item 54.

No explanation is given for why the region west of the Grand Canyon subsided almost a mile or why the Colorado Plateau might have tipped down to the southwest—the opposite of what a subducting plate would produce.

82. ● *Kaibab Plateau*. Today, the Kaibab Plateau rise 1,700 feet higher than Hopi Lake could have been, so *the Kaibab Plateau must have risen after Hopi Lake began spilling westward*. (Had Hopi Lake been higher than about 6,000 feet, it would have spilled out to the north instead of over the 7,700-foot-high Kaibab Plateau to the west.)

83. ● *Missing Mesozoic Rock*. Water spilling out of Hopi Lake would not sweep off the Mesozoic rock in the funnel, south of the funnel, west of the funnel, or off the Kaibab Limestone north of the Grand Canyon, including off the high Kaibab Plateau. Also, Mesozoic rock has been removed from all around Shinumo Altar, and yet Shinumo Altar lies near the wide end of the funnel but north of where Hopi Lake's waters

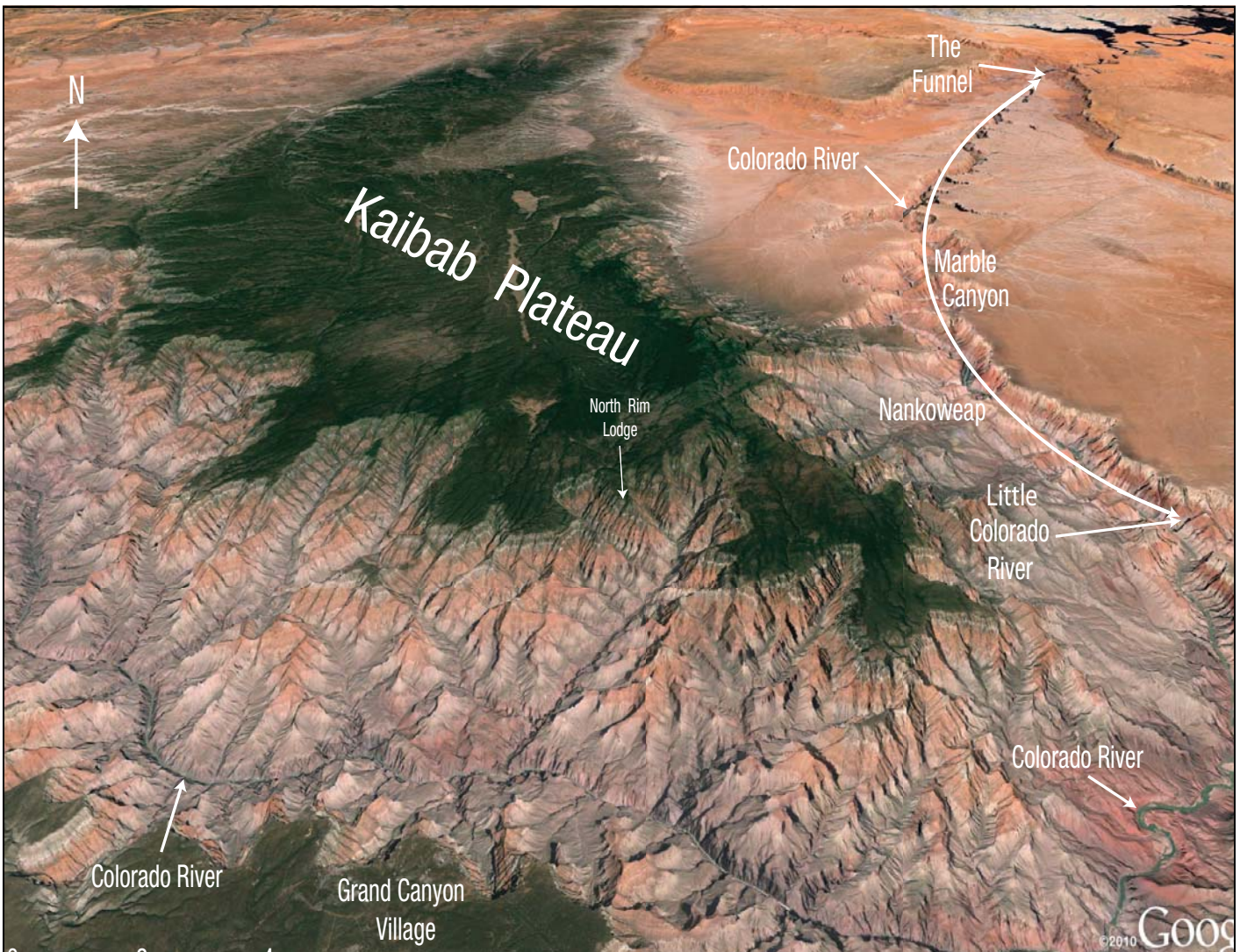

Figure 146: You Decide. Throughout this chapter, you have seen two conflicting perspectives: (1) the Colorado River carved the Grand Canyon after somehow penetrating the high Kaibab Plateau (shown by its green forests), and (2) Grand and Hopi Lakes breached their boundaries, carved the Grand Canyon and formed many surrounding terrain features, including the high, rapidly upwarped (via the water-balloon effect) Kaibab Plateau. Subsurface water then spilled out of the suddenly elevated Kaibab Plateau, down its steep slopes and eroded side canyons and valleys north of the river. As the Grand Canyon was cut deeper and deeper, subsurface water could also spill down the slopes on the south side of the river—a secondary effect that explains why more of the canyon lies north of the river. [See Figure 121 on page 218.] Also remember that the Grand Canyon extends 100 miles to the west of this picture.

Which of the above two perspectives fits the evidence? Could the Colorado River, which flows almost perpendicular to these side canyons and valleys, have carved them? Why are there no streams atop the Kaibab Plateau or the South Rim that discharge into these vast side canyons? Why does most of the Grand Canyon lie on the north side of the river? What initially cut the channel through the Kaibab Plateau that allowed the Colorado River to flow from the bottom right of this picture northwest 45 miles? Was it the Colorado River or all the water spilling out of Grand and Hopi Lakes and the subsurface water draining out of the southwestern side of the rapidly upwarped Kaibab Plateau? Is the Colorado River the cause or a consequence of the carving of the Grand Canyon?

would have traveled. (The Mesozoic rock in that butte was preserved because it was, and is, capped by hard rock.⁶¹) [See Figure 136 on page 231.]

84. ❌ **Fossils.** Same as item 23.

85. ❌ **Tipped Layers below the Great Unconformity.** Same as item 24.

86. 🟡 **Time or Intensity?** Same as item 25.

❌ **Other.** Today, the Colorado River, would have to flow 2,400 feet uphill if it were to flow into the basin that once held Hopi Lake. ❌ **Other.** The Colorado River, with its heavy sediment

load, could not have flowed into the basin that held Hopi Lake for long without filling it completely with sediments.

Final Thoughts

Probably more geology has been exposed and studied in the Grand Canyon than in any other place on Earth. Therefore, the Grand Canyon is an excellent laboratory for testing the methods and explanations geologists have taught for the last century. What is the verdict?

In words that few geologists would dispute, the Grand Canyon is a “hazy mystery, cloaked in intrigue, and filled with

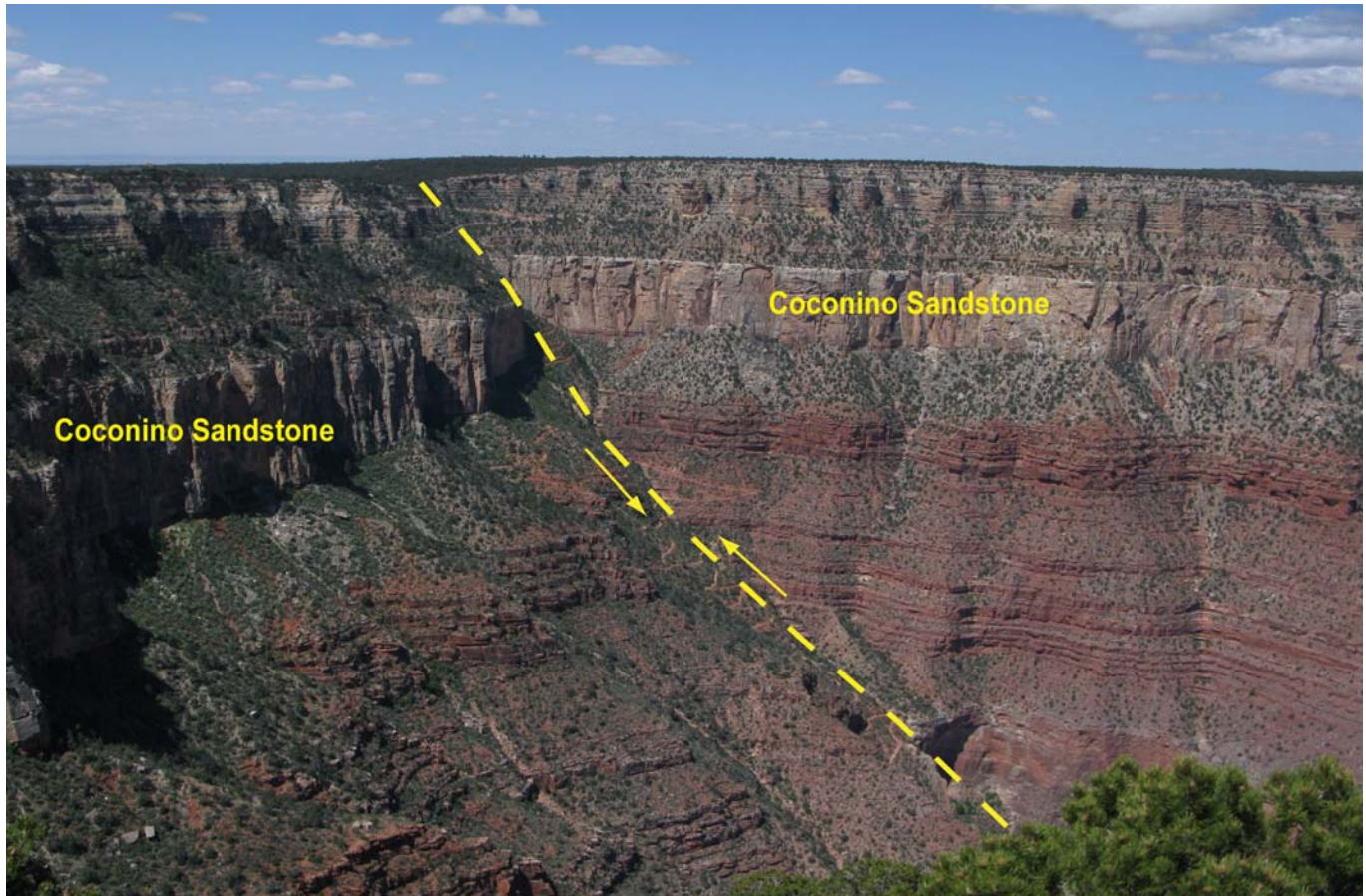

Figure 147: Looking south at the Bright-Angel Fault. Imagine the gigantic force required to fracture a horizontal slab of rock, more than a mile thick, along an inclined plane whose edge is marked by the dashed yellow line. That rock slab and the fractured surface extend some distance into the South Rim of the Grand Canyon (in front of the camera), but also 60 miles to the north behind the camera!

Now try to imagine a 300-mile long train loaded with the weight of 2,800 cubic miles of dirt (that had been eroded to form the Grand Canyon) plus enough water (equal to the volume of two Lake Michigans and one Lake Huron) to transport that dirt 400 miles out into the Gulf of California.

The train is traveling west along the path the Colorado River flows today. The depressed ground below that heavy train springs back up when the heavy train “spills” over the western edge of the Colorado Plateau that centuries earlier was lifted more than a mile. For every pound of dirt and water that spilled over that western edge, an additional pound of upward force acted to shear the slab and produce the fault. That rebound and the vertical vibrations were greatest at the western edge of the Plateau, so the horizontal slab is fractured (sheared) along the dashed yellow line, and the west side of the fault is lifted 200 feet higher than the east side of the fault. This dramatic fault and the break and offset of the Coconino Sandstone are easily seen from most of the North Rim.

*enigmatic puzzles.*³ Despite a century of concentrated effort by so many, their methods have produced recognized contradictions, and they have left much evidence completely unexplained. [See, for example, item 18 on page 242.]

What’s wrong?

- As explained on page 199, evolutionary geology has been built upon two faulty assumptions: uniformitarianism and superposition.
- The global flood has been rejected out of hand as a possibility.
- Most geologists show little concern that they do not understand the forces, energy, and mechanisms that produced movements on and inside the Earth. Examples include continental drift, other plate movements, the production and release of magma, faulting, earthquakes, and the movements described in Endnote 22 on page 252.

While some will say that these are difficult matters, the problems would be far less difficult if the above errors were not made. When the geological understanding of such a well-studied region as the Grand Canyon is so poor, what confidence should we have in explanations for less-studied regions?

It should be no surprise that the unexcelled Grand Canyon and the water that was in those two huge, high-elevation, postflood lakes are related to the most famous petrified forest and best-known mesa, butte, and spire region in the world—Monument Valley. Conversely, if mesas, buttes, and spires were formed over millions of years by meandering streams—the “textbook” explanation—then mesas, buttes, and spires should be more evenly distributed worldwide, not concentrated in this one basin on the Colorado Plateau.

A Controversy

All correspondence, documents, and background material that pertain to this controversy are available for anyone to read.⁹³ Others have read, studied, and reported on it. One of the clearest and most complete reports was a radio broadcast which can be heard at, <https://kgov.com/the-initial-conditions-that-preceded-the-Grand-Canyon>

If anyone feels this unfortunate situation should be resolved and can set up a recorded face-to-face meeting with all involved parties, I will, if physically possible, fully participate.

In 1972, I proposed the hydroplate theory. After a year of study and fieldwork in Arizona, Utah, and Colorado in 1986–1987, I located, using geological and topological features, a basin that once held an enormous, lake. I named it Grand Lake. [See Figure 119 on page 214 and Figure 140 on page 235.] Beginning, in my fall 1988 seminars in the United States and Canada and on a 16 September 1988 radio broadcast over 200 stations,⁹⁴ I described Grand Lake's key features, location and how its breaching formed the Grand Canyon in weeks. I first published this explanation for the Grand Canyon in July 1989.⁹⁵ Another extinct lake, Hopi Lake, was described earlier by R. B. Scarborough.⁹⁶

Dr. Steven A. Austin of The Institute for Creation Research (ICR), as he eventually admitted in writing, purchased that 1989, 5th edition of *In the Beginning* "in August 1989, weeks after it was published." [Steven Austin, personal correspondence, 29 August 1994.] In early 1990, Austin published, as if they were his, essential ideas of mine about Grand Lake and the formation of the Grand Canyon. I learned this on 7 May 1990, but said nothing about it for three years. On 4 November 1990, two people [initials J.B and D. B.] told me that Austin, on the previous day, said in a large public presentation that I took those critical ideas from him. Again, I kept silent.

By mid-June 1993, Austin's false allegations against me were spreading to a wide audience connected to ICR and starting to harm others. For example, in September 1992, Dr. Robert V. Gentry filmed me at the Grand Canyon presenting the Grand Lake explanation, as part of an expensive television production. Then, on 10 June 1993, Gentry called to tell me that Dr. Russell Humphreys (who had worked closely with Austin and was then at ICR) was reporting that I had plagiarized Austin's ideas. Humphreys later wrote that he did not use the word "plagiarize," but Gentry insists that was the intended meaning. Gentry told Humphreys that he did not believe that was true, but was naturally concerned about the consequences of those allegations for his costly film production, so he appealed to me for help. I then realized I had to address the issue.

By way of background, geologists have known since at least 1861 that canyons can be catastrophically carved in weeks by waters suddenly released by the breaching of a lake's boundary.²⁷ The discoveries of J Harlen Bretz in 1923 also showed this to generations of undergraduate geology students.³⁰

In 1980, Austin and many others saw that a small lake on Mount St. Helens had breached and the escaping water had quickly carved a tiny canyon. In 1985, John H. Whitmore, a student of Austin's, wondered in a term paper if the former Hopi Lake (now a dry lake bed directly east of the Grand Canyon) could have breached the Kaibab Plateau and carved the Grand Canyon. That would have been highly unlikely, because (1) the Kaibab Plateau is about 2,000 feet higher than Hopi lake could have been, (2) the water would have had to penetrate 30 miles of hard rock that was denser than concrete, and (3) any spillage down such a gradual slope to the west would erode little material.⁹⁷

In 1986, Dr. Edmond Holroyd told Austin that if a dam were built across the Colorado River near Grand Canyon Village, a vast lake, larger than Hopi Lake and Grand Lake

combined, would form. Holroyd drew his hypothetical lake on a map and noted that if a very long east-west fault had then developed between what are now the north and south rims of the Grand Canyon, the lake's escaping waters might have carved the Grand Canyon. However, no one has found such an east-west fault, and faults in the Grand Canyon region are typically perpendicular to the canyon, not parallel. Furthermore, a canyon that eroded along a fault would not bend or meander, as the Grand Canyon does.

The discoveries of Newberry²⁷ and Bretz³⁰ and speculations of Whitmore and Holroyd led Austin to wonder (in a very tentative way, as his writings show) if the breaching of Hopi Lake, directly east of the Grand Canyon, had carved the Grand Canyon. Austin probably knew the serious problems (mentioned above) that faced any proposal that the breaching of Hopi Lake carved the Grand Canyon. What Austin did not realize, as his writings exposed,⁹⁸ was that a much larger *and separate* postflood lake, Grand Lake, was north of Hopi Lake. Austin was unable to produce any spoken or written record showing that he knew, before 1989, anything about Grand Lake. However, in 1990, he published a map—shockingly similar to the one I had published in 1989—showing, as he labeled it, "Grand Lake" and giving its elevation (5,700 feet above sea level)—just as I had announced in many forums a year earlier in 1988 and published in 1989, along with the boundaries of Grand Lake and its breach point.

When Grand Lake breached, the escaping water also caused breaching of the northwest corner of Hopi Lake. The two very visible breach points define the north and south ends of Marble Canyon and explain many of its unusual characteristics described in this chapter. I call the northern breach point (where Grand Lake spilled) *the funnel*. [Pictures of it are on pages 222–226.] The southern breach point (where Hopi Lake spilled) is marked by the unique terrain where the Little Colorado River enters the Colorado River. The near-simultaneous breaching of both lakes catastrophically carved the Grand Canyon in weeks and upwarped the Kaibab Plateau via the water-balloon effect (explained on page 227). The torrent of water then cut down through the rising Kaibab Plateau. This chapter presents two-dozen other points of evidence, that I gathered in 1988–1989, that confirm the Grand Lake explanation.

The chapters "[The Hydroplate Theory: An Overview](#)" (pages 111–151), [Liquefaction](#) (pages 195–213), and [Limestone](#) (pages 260–266) fit together all the other pieces of the puzzle: What produced all the sediments, layered the strata, and sorted the fossils? What cemented the rocks so uniformly? Why does the Grand Canyon expose so much limestone? How was limestone produced? What raised the Kaibab Plateau, and how could the Colorado River flow through it? What forces, energy, and mechanisms buckled the Rocky Mountains? *The Grand Canyon would not exist if the Colorado Plateau had not first rapidly risen more than a mile above sea level, and lifted two large lakes. (Large lakes rarely form at such high elevations, where rainfall is rare, and evaporation is rapid.)*⁹⁹ If the Grand Canyon is a consequence of a global

flood, where did all the flood water come from, and where did all that dirt and water go? Centuries after the flood, was there enough water to transport 2,800 cubic miles of dirt, and where is it today? Attempts to explain the Grand Canyon without first answering these broader questions is incomplete. Of course, any explanation that is not accompanied by definite predictions is weak science. *The breached-dam explanation requires the hydroplate theory to explain many critical details.*

After pondering Bob Gentry's appeal for me to respond to Humphreys' false allegation, I realized I needed to go to the source of these spreading accusations that I stole Austin's ideas. (If I had simply been seeking priority, as some have alleged, I would have done so years earlier.) So, on 18 June 1993, I wrote Austin explaining the seriousness of the matter and asked if it was true that he had made these accusations against me. That same day, I also wrote ICR's Director, Dr. Henry M. Morris (now deceased) to inform him of this issue.

In all, Morris, Austin, and I exchanged six letters during the summer of 1993. Austin always denied that he had accused me of plagiarism (intellectual theft), although I explained how he could contact those who heard him make those allegations and clearly understood what he had said. He never contacted those witnesses. He also denied taking any ideas of mine, although some details he published were so specific that they obviously had come from my work. With each attempt to evade, he created more problems for himself and left his fingerprints.¹⁰⁰ (Mapmakers usually place on their maps tiny, unique details—even intentional errors—so that anyone who copies the map will be clearly shown to be guilty of copyright infringement.) Austin tried in several deceptive ways to show that he had come up with the Grand Lake explanation first. They were easily shown to be false—as a reading of all our correspondence clearly shows.⁹⁸

By 1991, Austin must have realized plagiarism and copyright infringement were shown by his using the name "Grand Lake" on a map in his Guidebook he sold. He then changed his name for the lake to "Canyonlands Lake." Having two names for the gigantic lake responsible for the formation of the Grand Canyon will continue to produce confusion and prevent others from going to the source for the evidence and full explanation for Grand Canyon's origin.

On 19 August 1993, I proposed in a letter to Morris and Austin that we put this unpleasant matter in the hands of an independent Christian arbitrator to thoroughly study and resolve, because we were unable to resolve it ourselves. Morris and Austin flatly refused. Denials and "bobbing and weaving" continued. Finally, after exchanging thirteen more letters, I told Morris and Austin that if they did not allow this matter to be arbitrated, so it would not create further discord, confusion, and accusations against my associates and me, I would make the issue public. They reluctantly agreed, but, in various ways, thwarted all efforts to seek arbitration. For example, after consulting with their lawyer, and only four days before the arbitration was to take place, they backed out of their written agreement to arbitrate and announced that they would participate only in nonbinding mediation. (Arbitration is binding.) After months of effort, and having finally reached an agreement on the time, place, and arbitrator, I felt betrayed. With plane tickets purchased and all preparations in place, I decided to proceed anyway, hoping mediation

would produce an agreement. Mediation occurred on 21 June 1994.

However, by 28 September 1994, Austin had clearly broken even the agreement we signed at the mediation, as a reading of our correspondence will show. I also wrote everyone involved (including Henry Morris and each member of ICR's board of directors) that Austin had broken the agreement. ICR's misinformation is still being spread. Therefore, to answer questions from those hearing this misinformation, the entire matter will be placed on the table for anyone to examine.⁹³ People can reach their own conclusion.¹⁰²

Notice that I followed the procedure laid out in Matthew 18:15-17. First, privately speak to the party you believe acted wrongly. Second, if he denies the allegations, present one or two witnesses to verify the allegations. Third, if that does not produce change, tell the church. I am now telling the church—the body of believers. Anyone wishing to receive a free CD containing all correspondence and writings between Morris, Austin, and me can simply mail a stamped, self-addressed CD mailer containing a blank CD-ROM and case to:

CSC, 5612 N. 20th Place, Phoenix, AZ 85016

Some have asked why Austin and I never worked together.

- ◆ My first attempt toward that end was in the summer of 1976. I flew to ICR in San Diego, in part to meet a "Stuart E. Nevins." At the time, I did not know that Austin had been writing under that fictitious name to conceal from evolutionists and the academic community that he was a creationist. At lunch with Henry Morris, I said that I would like to meet "Stuart Nevins." Morris, hiding the true situation, simply said that "Nevins" was out of town.
- ◆ In 1980, I flew to San Diego for a series of meetings with ICR's leadership. In an informal gathering, someone asked me to explain the hydroplate theory to the group. I declined, saying that I could not explain it in the brief time available. (Austin, who was listening in the next room and may have "planted" that question, walked in and urged me to explain the hydroplate theory, saying that he knew all the ideas about the flood and would quickly recognize what I had in mind. I began, but completed only a few sentences when Austin interrupted to tell the group a related story. A minute or two later, he excused himself to catch his ride home. Our gathering then dispersed.
- ◆ In March 1981, a friend of Austin's [initials T.M.] had just attended the first of 200 full-day seminars I conducted between 1981 and 1999 in the United States and Canada. He called Austin to urge him to learn about the hydroplate theory. Austin's response was simply, "I wish these nongeologists would stay out of our business." Later, I twice related this to Austin, but heard no denial or retraction, only silence—and a blank stare.
- ◆ Since 1984, false comments, derogatory letters, and negative innuendos about me have periodically come from ICR. Most recently, some at ICR have written that the hydroplate theory is "laughable." The specifics of these comments show that the writers have not read the theory.
- ◆ On several occasions, I have offered to debate the scientific merits of our respective understandings of the flood, but ICR always declines. One simple, quick

Tourists gaze at and geologists attempt to describe these magnificent, massive, and startling features, as well as the Goosenecks, petrified forests, slot canyons, Zion and Bryce National Parks, other canyons in the region, huge sand dunes and hundreds of mounds and “pits.” How did they form? Also, archaeologists have wondered for a century why the people who lived in the Nankoweap Basin suddenly left. Seldom understood are how all these features are related; the stupendous forces, energy, and mechanisms involved; and the event behind it all. Part II of this book describes that event.

Historians of science have frequently noted that once a persistent enigma is resolved, seemingly unrelated mysteries are also resolved. Science then takes a giant step

forward in what is called a *paradigm shift*, but the changed thinking doesn't happen overnight. It takes scientists and laymen (1) willing to reexamine old explanations in light of the new perspective and to follow the evidence where it leads, (2) ready to inform others of this new explanation and its supporting evidence, and (3) able to withstand scorn and misrepresentation from those whose income and prestige are tied to the old paradigm.

The origin of the Grand Canyon has been such an enigma, but it is just one piece of a much larger puzzle. Part II of this book (beginning on page 109) describes 24 other interlocking pieces. Their snug fit gives credibility to the explanations for all pieces. Collectively, they clearly show a global flood—Earth's defining geological event.

References and Notes

- Calculations in Table 7 were provided by Bryan Nickel.

Table 7. Volume of Grand and Hopi Lakes

Measurements	Grand Lake	Hopi Lake
Area	5.45×10^{11} ft ²	2.79×10^{11} ft ²
Elevation of Lake Surface ^a	5,700 ft	5,950 ft
Average Elevation of Lake Bottom ^{a, b}	4,875 ft	5,339 ft
Water Volume ^c	3.43×10^{14} ft ³ (2,333 miles ³)	1.24×10^{14} ft ³ (842 miles ³)

a. Above today's sea level.

b. Elevation profiles of the dried lake basins were generated using Google Earth.

c. As the Grand Canyon was carved, water released from water-saturated, flood-deposited sediments probably exceeded the water in both lakes combined.

2. “*Though scientists have studied the canyon for more than 150 years, a definitive answer as to how or when the canyon formed eludes them. The one thing scientists do agree on is that the canyon was carved by the erosive power of the Colorado River, but the river itself has carried away the evidence of its earlier history.*” Wayne Ranney, *Carving the Grand Canyon: Evidence, Theories, and Mystery* (Grand Canyon, Arizona: Grand Canyon Association, 2005), back cover.

 - ◆ “*Grand Canyon is somewhat unique among our national parks because of the lack of a single, scientific theory regarding its origin.*” Ranney, p. 20.
- Ranney, p. 11.
- The length of the Grand Canyon (216 miles) is often confused with the combined length (277 miles) of the Grand Canyon plus Marble Canyon. Both lie within Grand Canyon National Park.
- Bruce Babbitt, *Grand Canyon: An Anthology* (Flagstaff, Arizona: Northland Press, 1978), p. 50.
- “*... the suspended load carried by the river is prodigious. For the water year ending September 30, 1957, this load averaged more than 425,000 tons a day, or almost five tons each second. ... Average figures for a 50-year span are even higher—about 550,000 tons per day ...*” John S. Shelton, *Geology Illustrated* (San Francisco: W. H. Freeman and Co., 1966), p. 30.
- Some have joked that the Colorado River is too thick to drink, but too thin to plow.
- Layers of volcanic ash were found and dated in the limestone. [See Jon E. Spencer et al., “⁴⁰Ar/³⁹Ar Geochronology of the Hualapai Limestone and Bouse Formation and Implications for the Age of the Lower Colorado River,” *Colorado River: Origin and Evolution*, editors Richard A. Young and Earle E. Spamer, proceedings of a symposium held at Grand Canyon National Park in June 2000 (Grand Canyon, Arizona: Grand Canyon Association, 2001), pp. 89–91.]
- Stephen B. Castor and James E. Faulds, “Post-6 Ma Limestone along the Southeastern Part of the Las Vegas Valley Shear Zone, Southern Nevada,” in Young and Spamer, pp. 77–79.
- R. J. Rice, “The Canyon Conundrum,” *The Geographic Magazine*, Vol. 55, June 1983, pp. 288–292.
- “*... the Hualapai [Limestone] contains no evidence for a major river emptying into the lake in which the limestone precipitated.*” Ivo Lucchitta, “History of the Grand Canyon and of the Colorado River in Arizona,” *Grand Canyon Geology*, editors Stanley S. Beus and Michael Morales (New York: Oxford University Press, 2003), p. 270.
- “*Probably the most interesting discovery is that a canyon as deep and impressive as the Grand Canyon can be carved in just a few [1.7–4.5] million years—even in rocks that do not yield easily to erosion.*” Ivo Lucchitta, *Canyon Maker: A Geological History of the Colorado River* (Flagstaff, Arizona: Museum of Northern Arizona, 1988), p. 30.
- These rocks are of three types: (1) rim gravels, (2) a type of lava that caps gravel and colluvium, and (3) a debris fan that spilled out of Pierce Canyon and is deposited across the mouth of the Grand Canyon. [For details, see Lucchitta, “History of the Grand Canyon and of the Colorado River in Arizona,” pp. 269–270.]
- According to one famous geologist, no Colorado River sediments existed even 1,800,000 years ago.

*Did the Colorado River exist anywhere in Pliocene time?
If not, how and when may it have come on the scene? ...
There are, so far as known, no true river deposits older*

than Pleistocene along the entire course of the Colorado River—that is, deposits of the specific type that such a river normally lays down. Eliot Blackwelder, “Origin of the Colorado River,” *Bulletin of the Geological Society of America*, Vol. 45, 30 June 1934, pp. 554, 557.

12. “Under ordinary circumstances an uplifted plateau acts as a barrier to a river’s course, causing it to flow around that barrier through lower ground. Rivers do not normally flow into elevated plateaus but the Colorado River is not a normal river. It appears to cut right through this uplifted wall of rock, which lies three thousand feet above the adjacent Marble Platform to the east. This odd scenario was the foremost problem recognized by the very first geologists who saw the Grand Canyon. Why does the Colorado River seem to flow into the heart of an uplifted plateau?” Ranney, p. 22.
13. *The 1989 Information Please Almanac* (Boston: Houghton Mifflin Co., 1989), p. 544.
14. “Additionally, in Marble Canyon, many tributary streams come into the Colorado River flowing generally to the north, against the southerly flow of the modern [Colorado] river. This creates a pattern of drainage known to geologists as ‘barbed’ tributaries. The Marble Platform, into which the tributaries have been carved, also slopes down to the northeast exactly opposite the flow direction of the modern river.” Ranney, p. 23.



Figure 148: Deep Tension Fractures. Here, the ground split open in several places. (This location is ¼ mile southwest of 19-Mile Fault, and the camera is looking west near the east edge of Rider Canyon.) This deep, 1,500-foot-long crack is almost parallel to Rider Canyon and Marble Canyon. Fifty feet northeast of this crack is a parallel crack; a 500-foot-long parallel crack is on the opposite (west) edge of Rider Canyon. The sides of these cracks have not been offset vertically or horizontally, showing that they are tension fractures. As mass was removed when Rider Canyon and the funnel were rapidly carved, uplift, arching, and stretching occurred—producing the cracks. (The tall block in the center is tipping toward Rider Canyon.)

15. The entrance to Grand Canyon Caverns is located at 35°31'42.25"N, 113°13'59.81"W. The red smoke exited at 36°20'44.86"N, 112°43'17.78"W and undoubtedly traveled along Havasu Fault, which also exits at that point. [See Gary A. David, “A Dilemma of Horns,” *Four Corners Magazine*, February-March 2006, p. 4. Also see Pam Powers, *Recollections of the Grand Canyon Caverns* (Peach Springs, Arizona: Grand Canyon Caverns & Inn, 2006), pp. 4, 43.]



Figure 149: 19-Mile Fault. This fault crosses the Colorado River 19 miles downstream from Lees Ferry, which lies at the north end of the funnel. Here, looking southeast across Marble Canyon and the Colorado River, we can see the vertical line of subsurface drainage and mass removal along 19-Mile Fault. The fault continues along the solid white line shown in Figure 126 on page 223. On the ground, that line is marked by a broad depression (as seen above) and many sinkholes and hollow flow channels, all showing that water drainage removed considerable subsurface mass. At the northwest end of that white line (one mile behind my camera), is Rider Canyon where the fault is again exposed.

16. Troy L. Péwé, *Colorado River Guidebook* (Phoenix: Sims Printing Co., Inc., 1969), p. 44. (Péwé showed me these dense boulder fields, but unfortunately I took no pictures.)
 - ◆ For excellent pictures and locations of these boulders and a detailed description of the Nankoweap Delta area, see Richard Hereford et al., “Quaternary Geology and Geomorphology of the Nankoweap Rapids Area, Marble Canyon, Arizona,” U.S. Geological Survey, Report 502, 1998, pp. 1–18 and the accompanying map: 1-2608.
17. All dimensions for this profile were taken from Profile B–B’ on the outstanding “Geologic Map of the Eastern Part of the Grand Canyon,” 1986 edition, produced by the Grand Canyon Association.
18. For an interesting description of this arching, see Stanley S. Beus and Michael Morales, *Grand Canyon Geology* (New York: Oxford University Press, 1990), p. 5.
19. Along the Bright Angel Trail, from top to bottom, those thick limestone layers are Kaibab Limestone (350 feet), Toroweap Formation (250 feet), Redwall Limestone (450 feet), Temple Butte Limestone (35 feet), and Muav Limestone (375 feet).

Limestone forms only in the presence of water, but earth's sedimentary rocks contain so much limestone that if limestone formed in shallow seas, those waters would need to be toxic a thousand times over. [See pages 260–266.]

20. “*The forces that drove rock uplift of the low-relief, high-elevation, tectonically stable Colorado Plateau are the subject of long-standing debate.*” Mousumi Roy et al., “Colorado Plateau Magmatism and Uplift by Warming of Heterogeneous Lithosphere,” *Nature*, Vol. 459, 18 June 2009, p. 978.
21. “*Another curiosity with the Colorado River’s course is that it disregards the fault lines that cross its path. ... The Colorado River within the Grand Canyon crosses dozens of faults, many of them at right angles, ...*” Ranney, p. 22.
- ◆ Several of these more prominent, nearly vertical faults that are perpendicular to the Colorado River are 19-Mile Fault, Bright Angel Fault, Grand Wash Fault, Havasu Fault, Hurricane Fault, Muav Fault, Sevier Fault, Paunsaugunt (PAWN-suh-gant) Fault, and Toroweap Fault. Most of these named faults are more than 50 miles long. Probably most side canyons that are perpendicular to the Colorado River were initiated by faults that are no longer visible.
22. So-called explanations in geology frequently use words that have no basis in physics. For example, powerful movements are simplistically explained as an uplift, collision, subduction, upheaval, drift, tectonics, subsidence, convulsions, orogeny, crustal movements, stresses within the earth, or mountain building. Such vacuous terms avoid a clear description of the *forces, mechanisms and energy* involved. The emptiness of those words is usually hidden by claiming that the movement occurred over millions or billions of years. Only laymen are impressed. Time is a variable, not a mechanism.
- When hearing or reading such terms, one should ask whether a scientific, cause-to-effect understanding exists for the claimed motion.
- The hydroplate theory clearly identifies the forces, energy and mechanisms. In most cases, the force is gravity, and the mechanisms and energy involved are consistent with physics and have been seen by most of us on a small scale.
23. “*Oddly enough, the Grand Canyon is located in a place where it seemingly shouldn’t be.*” Ranney, p. 20.
24. The *Glossary of Geology*. It defines a plateau as:
Any comparatively flat area of great extent and elevation; specifically, an extensive land region considerably elevated (more than 150–300 meters in altitude) above the adjacent country or above sea level.
 [See Robert L. Bates and Julia A. Jackson, editors, *Glossary of Geology*, 2nd edition (Falls Church, Virginia: American Geological Institute, 1980), p. 482.]
25. Alexandra Witze, “Grand Canyon’s High Surroundings May be Product of Continental Lift,” *Science News*, Vol. 179, 21 May 2011, p. 12.
26. “*It doesn’t take millions of years to create an impressive channel. Flowing liquid can do a lot of work in a short period of time.*” Alan D. Howard, as quoted by Sid Perkins, “Texas Flood Carves Canyon in Days,” *Science News*, Vol. 178, 17 July 2010, p. 15.

27. John S. NewBerry, “Part 3: Geological Report,” in *Report upon the Colorado River of the West, Explored in 1857 and 1858 by Joseph C. Ives* (Washington D.C.: U.S. Government Printing Office, 1861; reprint, Ann Arbor, Michigan. University of Michigan, 2006), pp. 19–20.
28. *Ibid.*, p. 45.
29. “*When the geologist J Harlen Bretz proposed in the 1920s that the Channeled Scablands were created by a catastrophic flood, his ideas were attacked relentlessly by geologists who subscribed to the mainstream view that erosion is slow and steady, and who wanted to distance their profession from the notion of a biblical deluge.*” Perron, J. Taylor and Jeremy G. Venditti, “*Mega-floods Downsized,*” *Nature*, Vol. 538, 13 October 2016, p. 174.
30. John Eliot Allen et al., *Cataclysms on the Columbia* (Portland, Oregon: Timber Press, 1986), pp 98.
31. John Wesley Powell, *The Exploration of the Colorado River and Its Canyons* (1875; reprint, New York: Viking Penguin, 1987), pp. 89–90.
32. Carol S. Breed, “A Century of Conjecture on the Colorado River in Grand Canyon,” *Four Corners Geological Society Guidebook* (Flagstaff, Arizona: Museum of Northern Arizona, 1969), p. 63.
33. S. F. Emmons, “The Origin of Green River,” *Science*, Vol. 6, 2 July 1897, pp. 19–21.
34. Blackwelder, pp. 551–566.
35. This proposal was the consensus of experts on the Grand Canyon who attended a symposium led by Edwin D. McKee. [See Edwin D. McKee et al., *Evolution of the Colorado River in Arizona: A Hypothesis Developed at the Symposium on Cenozoic Geology of the Colorado Plateau in Arizona* (Flagstaff, Arizona: Northern Arizona Society of Science and Art, 1964).]
36. Charles B. Hunt, “Grand Canyon and the Colorado River, Their Geologic History,” *Geology of the Grand Canyon* (Flagstaff, Arizona: Grand Canyon Natural History Association, 1976), pp. 129–141.
37. Ivo Lucchitta, *Canyon Maker*, pp. 1–32.
- ◆ Ivo Lucchitta, “History of the Grand Canyon and of the Colorado River in Arizona,” pp. 260–274.
38. Norman Meek and John Douglass, “Lake Overflow: An Alternative Hypothesis for Grand Canyon Incision and Development of the Colorado River,” in Young and Spamer, pp. 199–204.
39. In 1987, after having supper with Larry D. Fellows, the State Geologist for Arizona, I asked him if a fault was in that region. Days later, after checking his files, he told me that he found no record of a fault. However, months later, I found an old river-runner map that showed a fault, called *19-Mile Fault*, where the Colorado River crosses the solid white line. During a raft trip down the Colorado River, I verified that the fault existed, but the north side of the fault was lifted only about 100 feet above the south side. [See Figure 149.]
- If the fault extended along the dashed white line in Figure 126 on page 223, it would be exposed inside Rider Canyon,

the barbed canyon to the northwest. Later, during a trip into Rider Canyon, the fault—and much more—were found!

Between Rider Canyon and Marble Canyon is what I will call a peninsula. If you look closely in [Figure 126](#), you will see that it narrows, or “necks down,” along the solid white line. [See also [Figure 125 on page 222](#).] Along that line are many sinkholes and a long depression. They show that subsurface water drained below that line and removed considerable material, as if the line marked a nearly vertical fault (a plane of weakness, slippage, and drainage). Drainage would have spilled out where the solid-white line segment intersected Marble and Rider Canyons, undercutting and removing material, thereby narrowing (necking) the peninsula.

Also, vertical cracks, several hundred feet deep, have dramatically opened along the edge of Rider Canyon. [See [Figure 148](#).] Some large blocks have fallen, or are about to fall, into Rider Canyon. The tension that split open and formed Marble Canyon no doubt produced these parallel cracks.

If block faulting produced the 2,000-foot Echo-Vermilion Cliff system as the Colorado Plateau was hydraulically uplifted, why was the fault’s offset, as seen at the Colorado River, only about 100 vertical feet and not 2,000 feet? Answer: As Grand Lake’s breaching removed mass south of the funnel, the south side of the fault steadily rose and arched upward, reducing the original offset. More mass was eroded as the ground rose, so even more ground rose. Movement stopped when the south side of the slightly *reversed* fault slammed into the north side. (Note: For upward movement to occur, block faulting will produce a slightly *reversed* fault, not a *normal* fault. Consult a physical geology textbook to understand the difference between normal and reverse faults.) “Plateau Uplift” on pages 226–227 explains the mechanics of block faulting.

These discoveries along the solid-white line segment in June 1988, convinced me that block faulting had occurred and that Echo and Vermilion Cliffs had been joined along the dashed white line. (Block faulting obviously occurred at several places directly north in Utah: Book Cliffs, Roan Cliffs, and the Grand Staircase.) The funnel also supports the presence of Grand Lake whose shoreline was 15–20 miles to the northeast. The funnel was carved as Grand Lake breached the 2,000-foot-high Echo-Vermilion Cliff. This led to the formation of Marble Canyon and the Grand Canyon.

40. The steps in the Grand Staircase were lifted sequentially from northeast to southwest, because the buildup of hydraulic pressure from the sinking Rockies would have occurred from northeast to southwest—from the closest point in the Grand Staircase to the Rockies to the farthest point.
41. The coordinates of this location (named Jack Point) are 36°41'56.76"N, 111°37'57.84"W.
42. H. S. Alexander, “Pothole Erosion,” *Journal of Geology*, Vol. 40, January–December 1932, pp. 305–337.
43. The Colorado Plateau has been lifted an average of 6,200 feet above sea level, *but the portion of the Moho directly below has been correspondingly depressed*. [See Professor George C. Kennedy’s statement on page 119.] This means

that the plateau was lifted by material injected between the plateau and the Moho.

Several miles above the Moho was the subterranean water chamber. [See [Figure 55 on page 124](#).] The chamber largely collapsed near the end of the flood and became a thin, ready-made conduit, corresponding to the thin, horizontal channel in [Figure 131 on page 226](#). Undoubtedly, some water remained at the floor-roof interface, but even with no water, the collapsed interface was the easiest path for magma to escape from beneath the sinking Rockies.

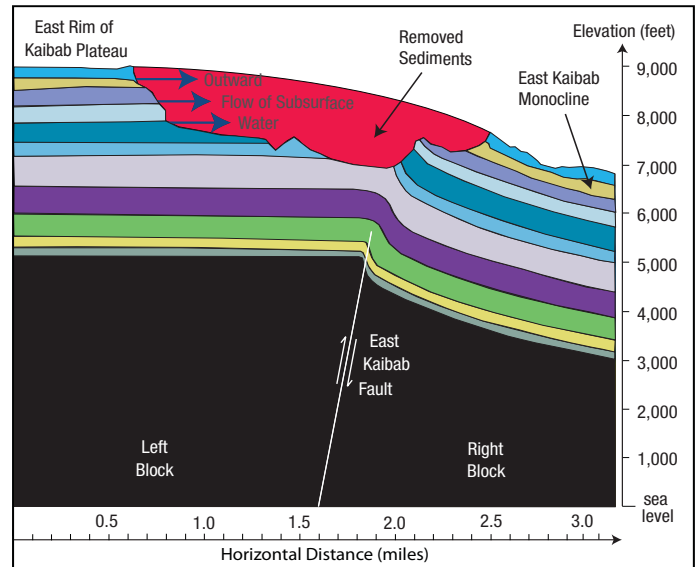

Figure 150: Looking North Along the East Kaibab Fault.¹⁷ Lifting of the north-south Kaibab Plateau⁴⁴ produced many vertical faults. One of the most dramatic was the East Kaibab Fault that parallels the Kaibab Plateau on its eastern slope, but extends farther to the north and south of the plateau. The western side of the fault was first lifted slightly above the eastern side. Then, subsurface water from the freshly exposed cliff—and sediments eroded by that water (shown in red)—spilled out to the east, shifting weight from the left block to the right block. As explained in “Plateau Uplift” on page 226, both blocks (shown in black) rested on trapped magma below, which allowed even greater displacements and multiple repeats of the lifting cycle. Today, in some places the vertical offset is more than 2,000 feet.

If you squeeze a fist-sized water balloon with both hands, you will notice that a slight increase in pressure on one side of the balloon quickly creates a bulge on another side. Likewise, shifts of weight from the left block to the right block acted quickly on the magma and water saturated sediments below to produce a bulge (or upwarp) under what would become the Kaibab Plateau. Also, as the upward bulge grew, the narrow torrent downstream from Hopi Falls cut down through the rising rock, removing even more weight from the left block and further increasing the Kaibab Plateau’s upwarp. Therefore, *today the Colorado River cuts through a mountain*.

The Kaibab Upwarp’s major block movements are clearly shown on the better geological maps of the region, but few geologists grasp the forces, energy, mechanism, or timing of these powerful events—or the role of the Rocky Mountains and so much water held within sediments deposited during the flood. Because most geologists hide their unknowns behind millions of years, refuse to consider the flood, and use impressive sounding (but vague) terminology, few scientists or laymen ever wonder or learn what happened.

44. While I follow convention in using the name “Kaibab Plateau,” as geologists and mapmakers have for a century,

technically it is not a plateau, but *an upwarp*. A plateau's layers are generally horizontal. The upwarp aspect of the "Kaibab Plateau" can be seen easily in the layers in the East Kaibab Monocline that slope downward like a ski slope.

What is a monocline? Lay a book on a table; then drape a handkerchief over the book and onto the table. The handkerchief's shape is that of a monocline. [See Figure 121 on page 218 and Figure 150 on page 253.]

What caused the bending or warping? The book on the table represents a block that rose by the hydraulic mechanism described in "Plateau Uplift" on pages 226–227. As the block rose, the wet, pliable layers above deformed into the shape of the handkerchief—and became a monocline.

Massive mudslides off the southeast end of the *rapidly rising* Kaibab Plateau exposed the East Kaibab Monocline. These mudslides are explained in item 13 on page 240.

Several brief conclusions can be drawn concerning the East Kaibab Monocline. A slab of hardened rock cannot be bent into the shape of this monocline without breaking. (I will bypass my page of mathematics showing this. Bending stresses would have fractured a *solid* slab of this size a hundred times over.) Obviously, the layers comprising the East Kaibab Monocline were wet and unconsolidated when they were bent (warped). After the bending, chemical agents in the water that saturated those sediments cemented them into a solid, but warped, layer.

In Figure 121 on page 218, the thinning of the monocline's layers to the left shows that they were originally wet and unconsolidated. This shows where the compression was greatest from the increasing upward hydraulic pressure that fractured the layers, producing the fault and monocline. Downward slumping also contributed to this thinning.

Figure 50 on page 117 shows other wet, flood-deposited layers that quickly deformed before they were cemented. They and the earth's major mountains were produced by crashing hydroplates. Immediately afterwards, these mountains began the sinking that pushed up plateaus.



PREDICTION 19: A very deep vertical fault lies beneath the steepest slope in the East Kaibab Monocline. Nonstratified sediments will be found on the downthrow side of the fault. Those sediments washed in to fill the void immediately after the fault formed. The edge of the uplifted block will be found to have slightly cut into the draped layer directly above.

Figure 50 on page 117 shows other flood-deposited layers that were wet and quickly deformed before they were cemented. They and the earth's major mountains were produced by crashing produced by crashing hydroplates. Immediately afterwards, these mountains afterwards, these mountains began the ins sinking that pushed up plateaus.



PREDICTION 20: A very deep vertical fault lies beneath the steepest slope in the East Kaibab Monocline. Nonstratified sediments will be found on the downthrow side of the fault. Those sediments washed in to fill the void immediately after the fault formed. The edge of the uplifted block will be found to have slightly cut into the draped layer directly above.

45. Angular rock fragments, called *xenoliths* (ZEN-oh-liths), are often found in magma flows. These fragments, which are millimeters to meters in diameter, sometimes contain diamonds. Geologists have always had difficulty visualizing how flowing magma could fragment and pluck out pieces of its conduit's thick wall. It is almost as strange as turning on your faucet and seeing pipe fragments—some of which contain diamonds—spilling into your sink.

Maybe flowing magma did not produce xenoliths. Perhaps some xenoliths were the result of very young, sinking mountains that crushed and slid rocks under great pressure and heat, generating magma—and diamonds.

46. George H. Billingsley, "Volcanic Rocks of the Grand Canyon Area," in Young and Spamer, pp. 223–229.

47. As magma was produced by the sinking of the Rocky Mountains, water would still have been trapped within the irregularities of the almost-collapsed subterranean water chamber. Water readily dissolves in magma. This lowers magma's freezing temperature (delays solidification) and makes magma less viscous (easier to flow). Approximately 70% (by volume) of all gases emitted from volcanoes is steam (water vapor). [See Gordon A. Macdonald, *Volcanoes* (Englewood Cliffs, New Jersey: Prentice-Hall, Inc., 1972), p. 50.]

48. Channels of magma may still connect large areas under the Rocky Mountains with large areas under the Colorado Plateau. If so, magma pressure is still tending to lift blocks in those portions of the Plateau, because the higher (heavier) Rocky Mountains would be exerting greater pressure on the magma than the lower (lighter) Colorado Plateau. Those blocks in the Plateau would be precariously locked by friction. The situation would be similar to a log jam on a large river, except the potential movement would be upward, not horizontal.

This also applies to other plateaus in the world. Removing enough mass from a plateau could destabilize it, the adjacent mountain range, and nearby regions. Seismic shocks, including those passing through the earth, could affect distant plateaus. A nuclear explosion, for example, on a large plateau could produce worldwide earthquakes.

49. Peter W. Huntoon and James W. Sears, "Bright Angel and Eminence Faults, Eastern Grand Canyon, Arizona," *Geological Society of America Bulletin*, Vol. 86, April, 1975, pp. 465–472.

50. See, for example, Tunnel Overlook at 36°09'00.77"N, 109°31'27.41"W.

51. A mesa is an erosional feature, not an uplifted region as is a plateau. A plateau's exposed layers correspond to those below the land surrounding the plateau. Plateaus are usually higher and wider than a mesa.

52. Millions of years or several weeks? Anyone giving the first answer would not be expected to provide specific details and evidence, because these features allegedly formed so long ago. Mentioning a few obscure technical words is usually sufficient. Besides, we have such difficulty imagining millions of years that we might be impressed that "science" has supposedly figured it out. Writers often capitalize on this impression by beginning their stories with dramatic, technical-sounding phrases, such as "Millions of years ago, ..."

Conversely, a person giving the second answer, which opposes conventional opinion and is shocking to some, is frequently expected to quickly provide convincing details and evidence. Despite this double standard, careful readers of this chapter will see the details and evidence for young ages, and why the Grand Canyon and surrounding features were carved in weeks—only a few thousand years ago.

53. "... *silicification is an impermeation (void-filling), not an organic replacement, process.*" Anne C. Sigleo, "Organic Geochemistry of Silicified Wood, Petrified Forest National Park, Arizona," *Geochimica et Cosmochimica Acta*, Vol. 42, September 1978, p. 1404.
54. A *saturated* solution contains the maximum amount of a dissolved solid, liquid, or gas under equilibrium conditions at a given temperature and pressure.
55. Not all sand is weathered rock. Some sand grains precipitated directly out of the silica-rich flood waters.
56. "*Preservation of such detail usually requires rapid infiltration of the petrifying material. If any of the tissues had already decomposed, mineral matter would have simply filled the hollow spaces left behind, preserving the wood's form but not its cellular structure.*" George Sheng, "Turning to Stone," *Science* 82, Vol. 3, March 1982, p. 69.
 - ◆ "... *silica nucleation and deposition can occur directly and rapidly on exposed cellulose surfaces.*" Sigleo, p. 1404.
57. Robert O. Fournier and Jack J. Rowe, "The Solubility of Amorphous Silica in Water at High Temperatures and High Pressures," *American Mineralogist*, Vol. 62, October 1977, pp. 1052–1056.
58. As subterranean water, saturated with silica and other minerals, escaped, its pressure and temperature rapidly dropped. Some water evaporated, but the liquid water remaining was *supersaturated* with silica. Dissolved silica particles would have been "frantically looking for" the tiniest cracks where they could come out of solution.
59. "*The majority of these trees [in Petrified Forest National Park] were very tall. On the average the logs are about 80 to 100 feet long and three to four feet in diameter, but some range up to 200 feet in length and ten feet in diameter at the base.*" Sidney Ash, *Petrified Forest: The Story Behind the Scenery* (Holbrook, Arizona: Petrified Forest Museum Association, 1985), p. 20.
60. Petrified Forest National Park plans to more than double its area. The park's southern half will expand to the east and west. As one would expect, the expansion is all within the boundary of the former Hopi Lake.
61. The hard rock is Shinarump Conglomerate. Shinumo Altar is located at 36°26'16.59"N, 111°43'11.19"W.
62. Eric Donovan, Personal communication, 5 September 2006.
63. Richard Foster Flint, *Glacial and Quaternary Geology* (New York: John Wiley & Sons, 1955), pp. 249–250.
64. This pit is located at 36°44'50.70"N, 109°35'10.36"W.
65. To be complete, both parts of this question (how and when) must be answered. Geologists feel that the "when" has already been answered; namely, "the Colorado Plateau was lifted during the last 80-million years." By locking in the timing before understanding the mechanism, they have become blinded to the physics involved. As Ranney states:

The exact reason why uplift [of the Colorado Plateau] has occurred in the Grand Canyon region remains speculative but certainly the area has been significantly elevated since the sea last left the area about 80-million years ago. Ranney, p. 44.
66. About 29% of the earth's surface is above sea level. The average elevation of land above sea level is 840 meters, or 2,756 feet. Therefore, pushing all land beneath the sea would raise sea level only $0.29 \times 2,756$ feet (or 800 feet).
67. Under Grand and Hopi Lake were thick water-saturated sedimentary layers. Once the lakes began their rapid drainage, that subsurface water (no longer contained by as high a water pressure) began escaping upward along the easiest escape routes. That began the deep erosion of lake-bottom sediments.
68. Two varieties of squirrels, which today live in only a few distinct locations worldwide, occupy the Grand Canyon region: the white-tailed Kaibab squirrel north of the canyon and the dark-tailed Abert squirrel south of the canyon. They are obviously related and, except for coloring, are indistinguishable. Each lives on an isolated plateau separated by several hostile environments and the 277-mile-long and several-miles-wide Grand and Marble Canyons. How could even one squirrel (let alone a male and female) traverse that formidable barrier? Probably the Grand Canyon was cut a few thousand years ago through an area occupied by the common ancestors of the Kaibab and Abert squirrels. Since then, the two isolated populations, unable to interbreed and with slightly different gene pools, developed different coloring—a classic case of microevolution (not macroevolution). [See John R. Meyer, "Origin of the Kaibab Squirrel," *Creation Research Society Quarterly*, Vol. 22, September 1985, pp. 68–78.]
 - ◆ Stewart Aitchison, a prominent Grand Canyon researcher, explains a related problem:

"[Both] squirrels occur only where there are ponderosa pine forests, for they depend almost exclusively on that particular pine species for food and nest building. ... Ponderosa pines probably did not spread into northern Arizona (presumably from the south) until the waning days of the last ice age. The Grand Canyon is at least several million years old. So how and when did the squirrel follow? So far, these are unsolved mysteries." Stewart Aitchison, *Grand Canyon's North Rim and Beyond* (Grand Canyon, Arizona, Grand Canyon Association, 2007), p. 24.

The mystery is easily solved. The Grand Canyon is not millions of years old. It is only about 5,000 years old.
69. The Navajo legend may give another reason for dating the Grand Canyon at least a few centuries after the global flood.

A great [local] flood threatened to drown the Navajo's ancestors. Suddenly an outlet was formed by rushing waters. The Navajo survived the flood by being transformed temporarily into fish. The outlet the flood waters formed is the Grand Canyon. Dan Goldblatt, *Grand Canyon*, Great National Parks Series (Pleasantville, New York: The Reader's Digest Association, Inc., 1988), video.

This legend implies that a local flood inundated northern Arizona. (Was it from the breaching of Grand and Hopi Lakes?) Survivors discovered the newly formed Grand Canyon, still carrying runoff from that local flood. If the legend is even partially true, the Grand Canyon formed recently, while people occupied that area, not millions of years ago.

Descendants of other early Americans who live near the Grand Canyon have similar legends that tell of a large flood. The Hualapai legend says that the Creator sent word to dig a huge hole to drain the land. As the waters receded, the Grand Canyon was left behind. The Havasupai tribe also tells of the Grand Canyon forming after a single, catastrophic flood. [See Ranney, pp. 84–85.]

70. This also applies if only the portion of the Colorado Plateau that held Grand or Hopi Lake tipped by 0.1°. If a block inside the lake tipped by this amount, shorelines would change to a lesser extent. Within Grand Lake's basin are large blocks that are faulted and tipped by many degrees. One example is Book Cliffs, so named because they resemble a row of books that partially toppled onto their sides after a bookend was removed. The 250-mile-long Book Cliffs are the longest continuous escarpment in the world.
71. Edmond W. Holroyd, III, "A Remote Sensing Search for Extinct Lake Shore Lines on the Colorado Plateau," *Proceedings of the Third International Conference on Creationism* (Pittsburgh, Pennsylvania: Creation Science Fellowship, Inc., 1994), pp. 243–254.
72. *Ibid.*, p. 245.
73. *These narrow slot canyons* [on the Colorado Plateau] *are among the strangest, most-interesting and fotogenic features on earth. ... There is simply no other place on earth quite like the Colorado Plateau.* Michael R. Kelsey, *Technical Slot Canyon Guide to the Colorado Plateau* (Provo, Utah: Kelsey Publishing, 2008), p. 7.
74. M. S. Steckler et al., "Multi-Channel Seismic Reflection Database for the Northern Gulf of California, a Highly-Sedimented Oblique Rift," *Geophysical Research Abstracts*, Vol. 5, 2003, pp. 1–2.
75. "... the submarine canyons in the Gulf of California exist only at the southern end." Charles A. Anderson et al., "1940 E. W. Scripps Cruise to the Gulf of California," *Geological Society of America Memoir 43* (New York: Geological Society of America, 1950), p. 361.
76. "Our preferred interpretation of the Chemehuevi Formation is that it contains the remnants of deposits formed during a single major episode of fluvial aggradation [sediment deposition by river flooding], during which the Colorado River filled its valley with a great volume of dominantly sand-size sediment." Daniel V. Malmom et al., *Stratigraphy and Depositional Environments of the Upper Pleistocene Chemehuevi Formation along the Lower Colorado River*, Geological Survey Professional Paper 1786 (Washington, D.C.: U.S. Government Printing Office, 2011), p. 2.
 - ♦ Wood found buried in the deposited sediments was dated at 35,100 radiocarbon years. [See Malmom et al., p. 16.] As explained in "How Accurate Is Radiocarbon Dating?" on pages 506–509, an age of 40,000 radiocarbon years corresponds to about 5,000 actual years—the time of the flood. Apparently, the carving of the Grand Canyon was at least several centuries after the flood.
77. "[William Morris Davis] and his followers found peneplains often in the geologic past, but, tellingly, nowhere in the present. The paradigm of a geologic cycle ending in a peneplain was to dominate the theory of physical geology for half a century." James Lawrence Powell, *Grand Canyon: Solving Earth's Grandest Puzzle* (New York: Pi Press, 2005), p. 155.
 - ♦ "... modern geologists do not find peneplains." *Ibid.*, p. 156.
78. Ranney, p. 23.
79. "New ³He_c [cosmogenic] and ³⁹Ar/⁴⁰Ar [argon-argon] ages show that volcanism and lava damming in this region occurred between 1 and 630 ka [1,000–630,000 years ago], rather than between 10 ka and 1.8 Ma [10,000–1,800,000 years ago based on potassium-argon dating] as previously reported." Cassandra R. Fenton et al., "Geochemical Discrimination of Five Pleistocene Lava-Dam Outburst-Flood Deposits, Western Grand Canyon, Arizona," *Journal of Geology*, Vol. 112, 2004, p. 91.
 - ♦ "K-Ar dating of basalts in the Uinkaret volcanic field is known to be problematic owing to excess ⁴⁰Ar incorporated into large phenocrysts from the magmatic environment and abundant glassy groundmass. Anomalously old ages for young basalts in other volcanic fields have been attributed to excess argon and low potassium concentrations." Cassandra R. Fenton et al., "Cosmogenic ³He Dating of Western Grand Canyon Basalts," in Young and Spamer, p. 147.
80. "Let us turn from speculation to what we can say with confidence. It is that the ultimate cause of the Grand Canyon is plate tectonics." James Lawrence Powell, p. 252.
81. [Once upon a time] "some 30 million years ago the Farallon Plate lay between the American and Pacific Plates. The two converged along a subduction zone that gradually consumed the Farallon Plate. By about 20 million years ago, it had vanished, leaving behind two smaller remnants: the Juan de Fuca and Cocos Plates. The Farallon Plate eventually traveled east for 1,500 kilometers, so far underneath North America that it caused the uplift of the Rocky Mountains." *Ibid.*, p. 213.
82. Ivo Lucchitta, "Development of Landscape in Northwest Arizona: The Country of Plateaus and Canyons," *Landscapes of Arizona: The Geological Story*, editors T. L. Smiley et al. (London: University Press of America, 1984), pp. 269–301.
 - ♦ See Endnote 88.
83. James Lawrence Powell, p. 191.
84. *Ibid.*, p. 256.
85. "There is no obvious reason to expect more rapid headward erosion from the drainage that became the Colorado River because this drainage incised the same rock units at Pigeon, Hidden, and Hobble Canyons farther north, descended from cliffs of similar or lower height, reached the same structural trough, and was subjected to the same climatic conditions." Jon E. Spencer and Philip A. Pearthree, "Headward Erosion Versus Closed-Basin Spillover as Alternative Causes of Neogene Capture of the Ancestral Colorado River by the Gulf of California," in Young and Spamer, p. 218.
86. "The idea of McKee and others that this basin received flow from the upper ancestral Colorado River cannot be justified based on ... the lack of basin accumulation space for the assumed sediment carrying capacity of an ancestral upper Colorado River." Todd A. Dallegge et al., "Age and Depositional Basin Morphology of the Bidahochi Formation and Implications for the Ancestral Upper Colorado River," in Young and Spamer, p. 51.
87. Hunt, p. 137.
88. "But both authors [McKee and Hunt] had arrived at their theories partly by elimination and partly by inference: no direct evidence ever turned up to support either." James Lawrence Powell, p. 206.
89. "However, the Hualapai is not restricted to the mouth of the Grand Canyon, but occurs over a wide area. It also contains evidence suggesting deposition in a number of separate lakes. It is difficult to attribute all these lakes to springs near the mouth of the Grand Canyon resulting from piping of the Colorado. Furthermore, the Hualapai does not occur only at

the top of the interior-basin sequence, as stated by Hunt, but throughout the exposed section [in some layers below the top].” Lucchitta, “Development of Landscape,” p. 294.

90. James Lawrence Powell, p. 200.
91. *Ibid.*, p. 205.
92. “Geologist George Billingsley mapped these same plateaus without finding outcrops of confirmed river gravel. As with the McKee and Hunt theories, the key evidence that would support Lucchitta’s idea has yet to appear, though it still could.” James Lawrence Powell, p. 210.
93. Anyone wishing to receive a free CD containing all correspondence and writings between Morris, Austin, and me can simply mail a stamped, self-addressed CD mailer containing a blank CD-ROM and case to:
CSC, 5612 N. 20th Place, Phoenix, AZ 85016
94. KTIS Radio, Minneapolis, Minnesota, 16 September 1988.
95. Walt Brown, *In the Beginning*, 5th edition (Phoenix: The Center for Scientific Creation, 1989), pp. 75–76, 83.
96. R. B. Scarborough, “Cenozoic Erosion and Sedimentation in Arizona,” *Arizona Bureau of Geology and Mineral Technology*, 16 November 1984.
97. Notice that the hydroplate theory explains how the Kaibab Upwarp formed as a result of the breaching of Grand and Hopi Lakes, and why the torrent of escaping waters cut down through that mountain as it rapidly rose. In other words, weeks after Grand and Hopi Lakes breached, the Kaibab Upwarp, the Colorado River, and Grand and Marble Canyons formed.
Austin, on the other hand, does not explain the Kaibab Upwarp, but believes it existed before the breaching. He wonders how the escaping waters of a lake cut through that mountain.
98. On pages 53–55 of Austin’s 1989 Grand Canyon Guidebook is the almost identical chapter that was in his 1988 Guidebook, “Evidences for Relic Landscape and Youthful Canyon.” In it was one surprising addition—Holroyd’s map showing where a lake larger than Grand and Hopi Lakes combined would have been, *if a gigantic, mile-long dam stretched across the Grand Canyon at Grand Canyon Village*. Might Austin have done that because Holroyd’s hypothetical lake was close to what Austin had just learned I was teaching in seminars and a radio program (broadcast over 200 stations on 16 September 1988) about Grand Lake and the origin of the Grand Canyon? On page 68 of Austin’s 1990 Guidebook is Holroyd’s same map, and on page 78, it is shown again as “Grand and Hopi Lakes.”
Holroyd’s one-page map and its caption was clearly a last minute addition to Austin’s 1989 Guidebook, because nowhere else in the chapter was it (or any related details) mentioned or explained, something careful authors or the discoverer of Grand Lake would not omit. Perhaps this last-minute addition was made because Austin, who had been trying to explain Grand Canyon’s origin for years, suddenly felt “scooped.” Was this a way he could claim that in 1989 he had proposed a specific lake (with an elevation of 5,700 feet) that breached and thereby carved the Grand Canyon?
But if Austin published his conclusions in 1989, that would not be soon enough, because I had been teaching and broadcasting my explanation in 1988—a broadcast whose audio recording—dated by the radio station—I still possess. Austin needed to claim that his discoveries were made in 1988. Therefore, he deceptively

placed a 1988 copyright date in his Guidebook—a book obviously printed in 1989, based on other dates in his book.

Austin certainly developed an interest in what I was saying because he quickly purchased my July 1989 book in August 1989, a month after it came off the printing presses. [Steve Austin, personal correspondence, 29 August 1994]. Later, Austin also used, without attribution in his 1990 Guidebook, the location, breach point, and elevation of Grand Lake that I discovered in 1986–1987.

Surprisingly, Austin never included a picture or mentioned the funnel—a steep, 18-mile long spillway that widened to 12 miles at its low (downstream) end. When I studied it from the ground in 1986–1987, it was obviously a massive erosion feature that required the sudden release of a large lake’s worth of water to carve. That feature alone dramatically shows that a gigantic lake breached. Austin was too capable a geologist to ignore such a feature, if he had seen it from the ground before 1989. In September 1992, a camera man on Gentry’s television crew and I and flew over the funnel in a rented plane to get good pictures of it for television.

99. Today, the world’s largest lake a mile or more above sea level is Lake Titicaca on the border of Bolivia and Peru in the Andes Mountains. Lake Titicaca holds only 15% the water that was in Grand Lake—not to mention Hopi Lake. [See page 139.]
Had the Colorado Plateau risen slowly as it lifted Grand and Hopi Lakes, the lakes would have rapidly shrunk (and maybe disappeared), because at high elevations there is rapid evaporation and little rain. However, in less than an hour (during the compression event) the Rocky Mountains were buckled up and then the Colorado plateau and its two big lakes began to rise hydraulically. [See pages 486 and 226.] Again, it is hard to see how the Grand Canyon could be explained without details provided by the hydroplate theory.
100. By adding Holroyd’s map to that chapter, Austin created several problems for himself, revealed his duplicity, and left his fingerprints. First, he had to remove one page to compensate for the added one-page map, otherwise he would have to renumber almost 200 subsequent pages in his *Grand Canyon Guidebook*, or reprint all those pages. Reprinting would have taken several hours with the Radio Shack daisy-wheel printer he used. Evidently, to save time, work, and expense, he simply removed four endnotes from pages 55 and 56, since they are read less frequently, and are less critical to the chapter’s message. Unfortunately, he had to paste over page numbers in that chapter that needed changing because of the added map. Revealing these last-minute problems was one paste-over that was cockeyed, an error a computer or typesetter would not have made.
101. When I pointed this out to Austin, he claimed that he accidentally put the wrong copyright page in his 1989 Guidebook. If so, Austin is admitting that the ideas in his August 1989 Guidebook were dated in 1989, after my 1988 broadcasts and seminars.
102. If anyone feels that this unfortunate situation should be corrected, and they can set up a publicly available, videotaped, face-to-face meeting with Austin or an ICR representative and me, I will make every effort to attend.
Alternatively, if Austin or the President of ICR, Henry Morris III, apologizes and acknowledges the above plagiarism and deception in writing, the matter will be removed from this book. I made a similar offer to Austin before publishing the 8th edition in 2008 and to Henry Morris III, on 12 September 2018. Unfortunately, they ignored my offers.



Figure 1: White Cliffs. An extensive layer of limestone is exposed on both sides of the English Channel: in the cliffs of Normandy, France (top) and the White Cliffs of Dover, England (bottom). This 600 – 1,000-foot-thick layer extends under the Channel and far into England and France. Was this region a shallow sea that somehow accumulated all this limestone, or was this limestone swept out of the subterranean chambers as the flood waters erupted onto the Earth’s surface? Answering this question will provide insight on the geologic history of the entire Earth—and much more.

The Origin of Limestone

SUMMARY: *Too much limestone¹ exists on Earth to have been formed, as evolutionists claim, by present processes on the Earth's surface, such as the accumulation of pulverized corals and shells. Had that happened, so much carbon dioxide (CO₂) would have been released that all of Earth's surface waters and atmosphere would have become toxic hundreds of times over.*

Before the flood, supercritical water in the subterranean chamber steadily dissolved certain minerals in the chamber's floor and ceiling, making them increasingly porous and spongelike.² This allowed even deeper dissolving. As explained on pages 126–127, rising temperatures in the chamber caused the limestone to precipitate (out salt) onto the chamber floor. During the flood, the escaping subterranean water swept the precipitated limestone up to the Earth's surface.

About 20% of all sedimentary rock is limestone.³ Any satisfactory explanation for the world's sedimentary layers and fossils should also explain the enclosed limestone layers and limestone cement. This requires answering two questions, rarely asked and perhaps never before answered:

1. *What is the origin of the Earth's limestone?* Remarkably, Earth's limestone holds a thousand times more calcium and carbon than today's atmosphere, oceans, coal, oil, and living matter combined. A simple, visual examination of limestone grains shows that few are ground-up seashells or corals, as some believe.
2. *How were sediments cemented to form rocks?* Specifically, how were large quantities of cementing agents (usually limestone and silica) produced, transported, and deposited, often quite uniformly, between sedimentary grains worldwide? Especially perplexing has been finding the source of so much silica and the water to distribute it. Geologists call this “the quartz problem.”⁴

Answering these questions in the context of the hydroplate theory will answer another question: What was the source of the carbon dioxide (CO₂) needed to reestablish vegetation after the flood? Remember, preflood vegetation was buried during the flood, most of it becoming coal, oil, and methane.

Limestone Chemistry. Limestone, sometimes called calcium carbonate (CaCO₃), is difficult to identify by sight, but is quickly identified by the “acid test.” If a drop of any acid, such as vinegar, is placed on limestone or a rock containing limestone, it will fizz. The acid combines with the limestone to release fizzing bubbles of CO₂ gas. As you will see, limestone and CO₂ gas are intimately related.

Another common chemical reaction involving limestone begins when CO₂ dissolves in water, forming a weak acid (carbonic acid). If that slightly acidic solution seeps through ground containing limestone, limestone will dissolve until the excess CO₂ is consumed. (This is how limestone is hollowed out, forming limestone caves and voids that can produce sinkholes.) If that solution then seeps into an existing cave, evaporation and loss of CO₂ will reverse the reaction and precipitate the limestone in the solution, often forming spectacular stalactites and stalagmites.

A third example of this basic reaction is “acid rain.” With the increase in atmospheric CO₂ in recent decades, especially downwind from coal-burning power plants, CO₂ dissolves in rain, forming “acid rain.” Acid rain can harm vegetation and a region's ecology if not neutralized, for example, by coming into contact with limestone.

Finally, limestone sometimes precipitates along the coasts of some eastern Caribbean islands, making their normally clear coastal waters suddenly cloudy white. Studies of this phenomenon have shown that limestone precipitates when CO₂ suddenly escapes from carbonate-saturated groundwater near the beach.⁵

These four examples are described by the following reversible chemical reaction.

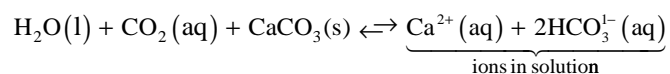

In other words, when liquid water [H₂O(l)] containing dissolved (or aqueous) CO₂ [CO₂(aq)] comes in contact with solid limestone [CaCO₃(s)], the limestone dissolves and the chemical reaction moves to the right. Conversely, for every 100 grams of limestone that precipitate, 44 grams of

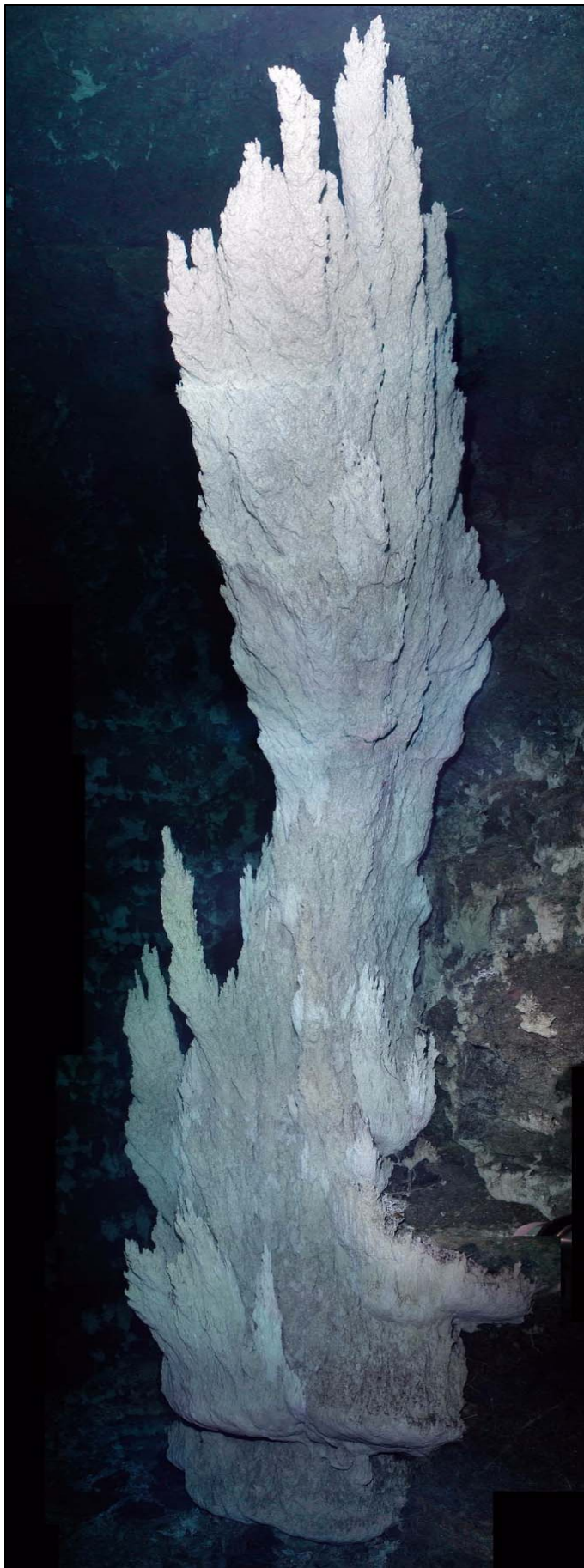

Figure 2: Limestone Chimneys. We can now see where limestone was produced—in the former subterranean chamber.

Before the flood, supercritical water (SCW) in the subterranean chamber dissolved and hollowed out the more soluble minerals in the chamber's floors and ceilings. Those tiny spongelike openings then filled with SCW and dissolved chemical elements, some of which later precipitated (out-salted) as mushy limestone particles. Today, SCW jetting up from many places on the ocean floor (the former chamber floor), sweeps some of those particles up, forming limestone chimneys—similar to inverted stalactites. This chimney rises 180 feet above the ocean floor and is up to 10 feet in diameter. It is one of many near the Mid-Atlantic Ridge in a region called "The Lost City." [See Figures 55 and 56 on page 124 and 125.]

CO_2 escape the solution and the reaction shifts back to the left. Little temperature change occurs with either reaction.⁶

Production of Earth's Limestone. Supercritical water (SCW) readily dissolves certain minerals and other solids. [See pages 126–127.] As SCW's temperature steadily rose in the preflood subterranean chambers, more and more substances dissolved in the water such as: sodium, chlorine, calcium, carbon, oxygen, copper, aluminum, and iron. Later, as the temperature rose further, they precipitated as salt (NaCl), limestone ($CaCO_3$), and various ores—a process in SCW called "out-salting." Thick deposits of these mushy solids accumulated on the preflood subterranean chamber's floor.

Today, when limestone forms *at the Earth's surface*, the released CO_2 enters the biosphere—the atmosphere, soil, and surface waters of the Earth. Before the flood, vast amounts of limestone steadily precipitated onto the subterranean chamber floor, but the released CO_2 was confined to the chamber, unable to escape into the biosphere. That CO_2 again dissolved in subterranean water and was used to dissolve more minerals in the chamber's ceiling and floor. Therefore, Earth's preflood limestone was produced without the obvious life-extinguishing problem described in Table 8 and the paragraph that follows it.

Here's another way to look at the preflood production of limestone. The chemical equation above states that to form one molecule of limestone, one molecule of CO_2 must also come out of solution. In the subterranean chamber, that CO_2 went immediately back into the solution, so that CO_2 molecule was used over and over. No net CO_2 was emitted.

During the flood, pressure in the escaping water rapidly dropped, so some additional limestone precipitated and a relatively small amount of CO_2 gas escaped into the biosphere. Simultaneously, enormous amounts of limestone sediments on the chamber floor were swept up to the Earth's surface, where liquefaction sorted the limestone particles into more uniform layers. [See pages 195–213.]

Sediments, eroded during the initial stages of the flood, settled through the flood waters all over the Earth. After most of these waters drained into the newly formed ocean

basins, limy (CO₂-rich) water filled and slowly migrated through pore spaces between sedimentary particles.

After the flood, plentiful amounts of CO₂ in the atmosphere provided the necessary “food” to help reestablish Earth’s vegetation, especially forests. As plants grew and removed CO₂ from the atmosphere, surface waters could release additional CO₂ into the atmosphere, thereby precipitating more limestone. (A balance is always maintained between the amount of each specific gas in the atmosphere and the concentration of that gas in Earth’s surface waters.⁷) Limestone that precipitated between loose sedimentary grains cemented them together into rocks. Earth’s surface waters are still huge reservoirs of CO₂. Oceans, lakes, rivers, and groundwater hold 50 times more CO₂ than our atmosphere.

Tiny particles of precipitated limestone are excellent cementing agents when near-saturation conditions exist. Smaller and more irregular particles of limestone readily dissolve; larger particles grow, sealing cracks and gaps. Precipitation within a closely packed bed of sediments (cementation) occurs more readily than precipitation outside the bed.

Eight Observations That Are Now Explained

1. Volcanic Gases. By volume, CO₂ makes up approximately 20% of all volcanic gases; 70% is steam.⁸ This water and CO₂ came from the subterranean water.

2. Carbon Distribution. Could today’s surface waters have always been at the Earth’s surface while the Earth’s limestone slowly precipitated? Not based on the surprising distribution of carbon on Earth. Table 8 shows that much more carbon exists in limestone than in all other sources combined.

Here is the problem. The above chemical equation shows that for every carbon atom precipitated in limestone, a carbon atom is released in CO₂. At the Earth’s surface, this gas enters the biosphere. Had all limestone slowly precipitated in surface waters, as much carbon would have been released into the atmosphere and surface waters (as CO₂)

Table 1. Approximate Distribution of Earth’s Carbon^{9,2}

Place	Amount of Carbon (10 ¹⁵ grams)
Atmosphere	720
Animals and Plants (living and dead)	2,000
Coal and Oil	4,130
Oceans (inorganic)	37,400
Sediments (primarily limestone)	> 60,000,000

as was precipitated in limestone (as CaCO₃). Earth’s limestone contains more than 60,000,000 × 10¹⁵ grams of carbon. That amount of carbon in the atmosphere and

seas would have made them fatally toxic hundreds of times over. *Life would have ceased.* Today, the atmosphere and seas contain only (720 + 37,400) × 10¹⁵ grams of carbon.

3. Rapid Stalactite and Stalagmite Formation. Frequently the claim is made that stalactites and stalagmites required millions of years to form. More and more people recognize that this conclusion assumes that these limestone formations always grew at today’s extremely slow rates. [See Figure 30 on page 37 and Figure 153.] With so much water draining through freshly deposited limestone after the flood, stalactites and stalagmites grew rapidly.

Acidic groundwater, plentiful during the centuries after the flood, frequently seeped into cracks in limestone rocks, dissolved limestone, and formed underground caverns. As ventilation in caverns improved and plant growth removed CO₂ from the atmosphere, CO₂ escaped from this groundwater. Large quantities of limestone precipitated, rapidly forming stalactites and stalagmites worldwide.

4. Organic Limestone. Shallow-water organisms, such as corals, shelled creatures, and some types of algae, remove dissolved limestone from seawater to build hard body parts. (The more abundant the dissolved limestone, the faster the growth rates. Thus, coral growth rates were much higher after the flood.) Because some organisms produce limestone, evolutionists conclude that almost all limestone came from organisms, so hundreds of millions of years are needed to explain thick deposits of limestone. Instead, organic limestone is a result of the presence of inorganic limestone, not its cause. Inorganic limestone precipitated rapidly from the subterranean water before and during the flood. Surface waters could not have held the 60,000,000 × 10¹⁵ grams of carbon needed to produce today’s limestone without making them hundreds of times too toxic for sea life to exist.

For two other reasons, we can reject the common belief that most limestone has an organic origin. Wave action and predators can fragment shells and other hard parts of marine organisms. However, as fragments become smaller, it is more difficult to break them into smaller pieces. With increasingly smaller pieces, the forces required to break them again become unreasonably large before the pieces reach the size of typical limestone grains.

Finally, organic limestone is structurally different from and more intricate than inorganic limestone. Organic limestone crystals are more uniformly sized, oriented, and packaged—characteristics now detectable with high magnification.¹⁰ Earth’s vast limestone layers are overwhelmingly inorganic.

In summary, while much limestone precipitated before and during the flood, seawater still contains dissolved inorganic limestone. Algae, corals, and shelled creatures take in these dissolved chemicals and produce intricate organic limestone.

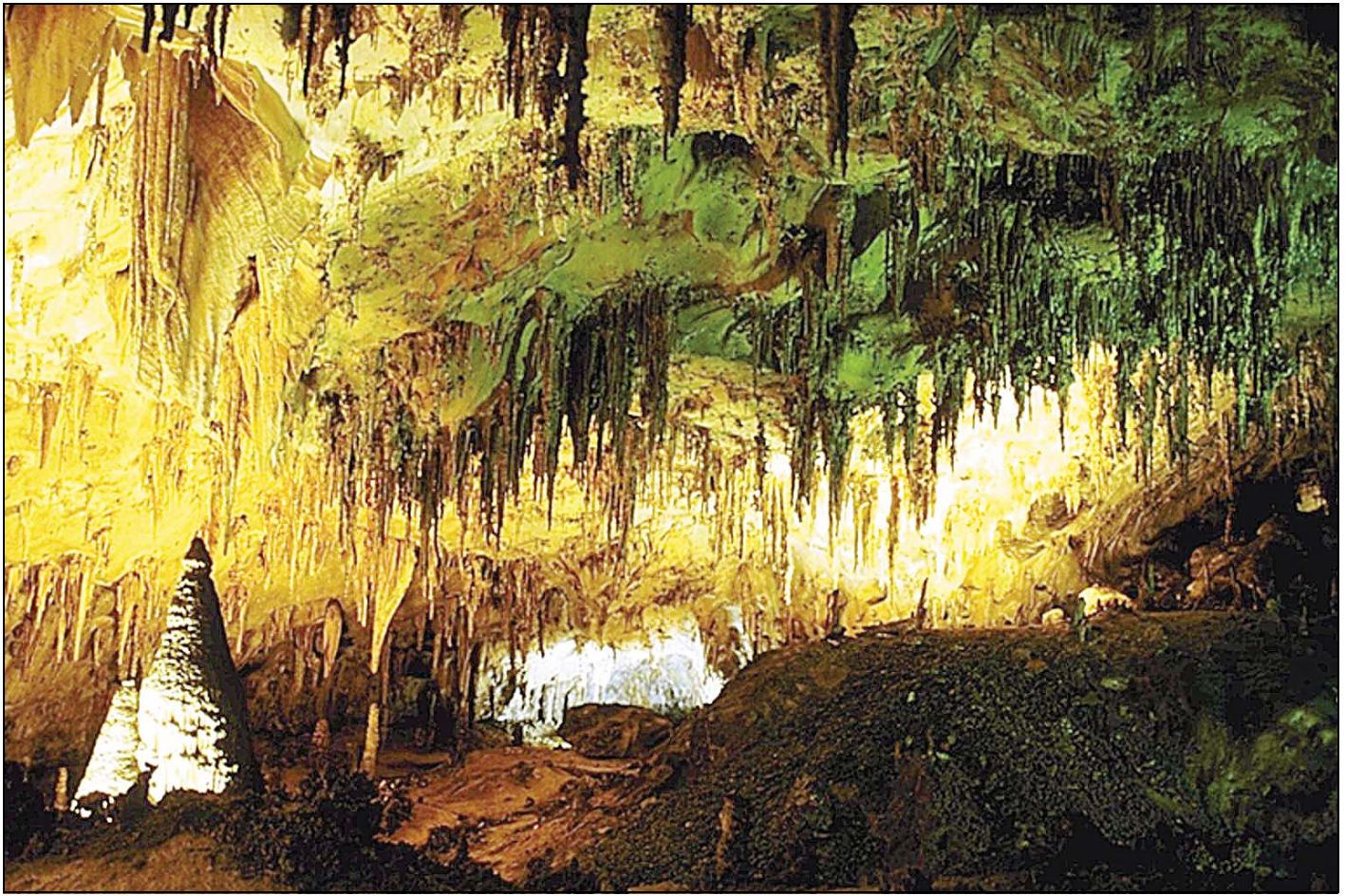

Figure 3: Carlsbad Caverns, New Mexico. U.S. Forest Service cave expert, geologist Jerry Trout states, “What geologists used to believe was fact, in terms of dating a cave, now is speculation. . . . From 1924 to 1988, there was a visitor’s sign above the entrance to Carlsbad Caverns that said Carlsbad was at least 260 million years old. . . . In 1988, the sign was changed to read 7 to 10 million years old. Then, for a little while, the sign read that it was 2 million years old. Now the sign is gone.” Trout also says that geologists don’t know how long cave development takes, and through photo-monitoring, he has watched a stalactite grow several inches in a matter of days.¹¹ [Also see Figure 30 on page 37.]

5. Thick Limestone Banks and Chalk. Scattered off the east coast of the United States are thick limestone deposits. Most dramatic is the Bahamas Bank, an area 250 by 800 miles, where “seismic evidence suggests that carbonate strata may extend down as far as 10 kilometers [6 miles].”¹²

If limestone formed organically in shallow seas (the prevailing view), why would the seafloor slowly subside almost 6 miles to allow these accumulations? Subsidence rates would have to be just right during the millions of years needed for organisms to grow and accumulate to such depths. Besides, the seafloor cannot subside unless the rock below it gets out of the way. That rock would have nowhere to go.

Apparently, the flood waters escaping from under the northeastern edge of the Americas hydroplate dumped limestone at the Bahamas Bank.¹³ Similarly, waters escaping from under the northwestern edge of the European-Asian-African hydroplate dumped limestone in and around what is now the English Channel. Later, in warm surface waters, rich in dissolved limestone, vast algae

blooms—perhaps daily—produced the soft, fine-grained type of limestone known as chalk. As long as nutrients and sunlight are plentiful (as was the case following the flood) algae blooms will expand exponentially. The algae die quickly and sink to the bottom of the sea. Most famous are the exposed layers in England’s White Cliffs of Dover and France’s Normandy coast. [See [Figure 151](#) on page 259.]

Some deep-sea sediments include the components of chalk: silicate and calcareous (limestone) structures secreted by tiny organisms, such as foraminifera and coccoliths (a type of algae). Today, when they die, their hard body parts settle to the ocean floor too slowly to (1) bury and fossilize larger animals or (2) achieve the purity seen in famous chalk deposits. Because thick and very pure chalk deposits worldwide preserve many large fossils, including soft-body animals, deposition had to be rapid. Secondly, the microscopic organisms that form chalk must have abundant sources of dissolved limestone and silica—exactly what algae blooms require and the warm waters from the subterranean chambers provided. Powerful wave action, driven by the fluttering crust (explained on page 197) and



Figure 4: Redwall Limestone Exposed in and around the Grand Canyon. Stained red from iron oxide impurities, the 400-foot-thick Redwall Limestone extends over most of northern Arizona. If it formed in a shallow sea (25–50 feet deep), how did such great thicknesses develop? How could another famous limestone formation, the 6-mile-thick Bahamas Bank, form?

mountain building events, could have easily scoured, transported, and dumped these low-density sediments into thick, pure, fossil-bearing, chalk deposits.

6. The Dolomite Problem. If a microscopic limestone crystal grows in a magnesium-rich solution, magnesium ions will, under certain conditions, occupy or replace exactly half the calcium ion locations in limestone, forming a common mineral called *dolomite*.

Geologists frequently refer to “the dolomite problem.” Why is it a problem? Organisms rarely secrete dolomite, certainly not in the quantities needed to account for thick dolomite deposits. If organisms deposited almost all limestone over millions of years, how did dolomite form?

Dolomite is frequently found in contact with limestone and is strangely distributed on Earth. It has hardly ever formed in recent times.¹⁴ Therefore, magnesium-rich solutions must have been much more abundant when older rocks were deposited. [See [Table 9](#).]

Some geologists reject precipitation of dolomite because of “the great thicknesses of dolomite rock that are found in the geologic record.”¹⁵ Others say that a lot of magnesium-rich water trickled through limestone, but that raises even

more problems. How did it trickle so uniformly through such great depths? Why would this “trickling” happen so often near limestone—and primarily in the ancient past? What was the source of the magnesium?

Basalt contains large amounts of magnesium, so the supercritical water dissolved minerals containing magnesium. Therefore, the presence of dolomite near limestone and the even distribution of magnesium in what would otherwise be limestone is easily understood.

7. Worldwide Cement. Evolutionists believe that most limestone was produced organically in shallow seas, because corals and shelled creatures live in shallow seas, which are generally warmer and have higher evaporation rates. With greater evaporation, the remaining solution is more likely to reach concentrations at which organisms can produce shells and other forms of limestone.

Organic limestone is primarily produced within 30 degrees of the equator. However, limestone layers and cement are not concentrated near the equator. Rocks, cemented with limestone, are found at all latitudes. Obviously, whatever produced inorganic limestone was global in scope.

Table 2. Dolomite: Observations¹⁶ and Explanations

Observations	Hydroplate Explanations
“Dolomites are associated almost exclusively with two other rock types: limestone and evaporites [such as salt].”	Similar conditions were involved in depositing large amounts of dolomite, salt, and limestone.
“Dolomites occur in approximately the same tectonic and physiographic settings as limestones: on the shallow shelves of low-lying continents, most commonly far from the nearest convergent plate margin [ocean trenches].”	Dolomite and limestone are often found near the edge of a hydroplate. They would rarely be found near ocean trenches (so-called “convergent plate margins”).
“[Dolomite] is rare in modern carbonate environments [but is abundant in lower layers].”	Little dolomite forms today, because the magnesium was released in the subterranean chamber where it was quickly consumed by limestone to form dolomite.
“Fossils are noticeably less common in dolomites [than in limestone].”	Fossils found in limestone are usually organisms that thrive in limy waters: corals, foraminifers, bryozoans, and crinoids. They evidently were buried by postflood deposition of limestone.
“The contacts [of dolomites] with limestone above and below are usually sharp.”	Liquefaction produced sharp contacts.

8. Limestone and Silica Cement. As dissolved CO₂ slowly escaped the flood waters, limestone and quartz precipitated into the tiniest cracks it could find. In this way, cementing occurred. (This solves “the quartz problem.”⁴)

After limestone, silica (SiO₂) is the second most common cementing agent in rocks. Derived from quartz, silica dissolves only 6 parts per million in pure water at 77°F (25°C). As temperatures rise, more silica goes into solution. At 300°F (150°C), silica concentrations reach 140 parts per million. If a silica-rich solution occupied the pore space between sand grains, silica would precipitate on their solid surfaces as the water cooled, cementing loose grains into rocks.

Only under high pressure can water reach such high temperatures. The hydroplate theory shows how both high temperature and pressure conditions existed in the subterranean chamber. [See page 126.] Also, frictional sliding of deep rock surfaces and plastic deformations generated enormous heat, which melted rock, forming magma. These hot surfaces heated deep, high-pressure water containing abundant quartz grains.

Sediments fell through silica-rich water. Therefore, the cementing solution was automatically in place between deposited sedimentary particles. It is difficult to imagine another scenario in which so much superheated liquid water could dissolve silica, distribute silica-rich solutions worldwide, and then, before they cooled, force them down into sediments where cementing could occur.

Silica also plays a role in the petrification of wood. As the flood waters drained, continental basins became lakes. Trees floating in warm postflood lakes often became saturated with silica-rich solutions. Petrification occurred as the water cooled and silica precipitated on cellulose

surfaces. Petrification has been duplicated in the laboratory when silica concentrations reach 140 parts per million.¹⁷ Arizona’s famous petrified forest lies in the center of what was Hopi Lake, while the petrified logs in Utah’s Escalante Petrified Forest and along the Green River both lie in what was Grand Lake. The sudden emptying of both lakes eroded the Grand Canyon. [For many more details about these lakes, petrified wood, and the formation of the Grand Canyon, see pages 215–257.]

Final Thoughts

We have seen the consequences of the flood at the Earth’s surface and below. In this chapter, we saw that Earth’s vast limestone deposits are not adequately explained by evolutionary scenarios, but are best explained by the hydroplate theory.

In later chapters, we will look far above and see in many ways that the fountains of the great deep—powerful beyond description—expelled muddy water and rocks far into outer space. Some of those rocks, called *meteorites*, have since fallen back to Earth. Those that were in contact with the subterranean water before the flood contain traces of the substances dissolved in that water. Some even contain small quantities of water and limestone. [See “**Meteorites Return Home**” on page 351.]

Up until the last few years, meteorites were mishandled in the laboratory, so these traces were lost. Sadly, meteorites were cut open using saws lubricated and cooled by water. The water redissolved these important chemical traces in the meteorites and carried them down the drain.

In 2000, a meteorite was discovered containing traces of many salts found in our oceans. As one authority stated, “The salts we found [in the Nakhla meteorite] mimic the salts in Earth’s ocean fairly closely.”¹⁸ However, there was one big difference; *limestone traces were a hundred times more abundant than expected.*¹⁹ Again, this is consistent with the hydroplate explanation that most limestone came from the subterranean water chamber.

Incidentally, some meteorites are said to be from Mars. Before you accept that assertion, please read “**Are Some Meteorites from Mars?**” on page 353. The so-called “Martian meteorites” all “show evidence of being subjected to liquid water containing carbonate, sulfate, and chloride . . .”²⁰ Therefore, instead of coming from Mars, they were probably part of the rock in direct contact with the subterranean water before the flood.

Communications with Dr. C. Stuart Patterson (former Academic Dean at Furman University and Professor of Chemistry, Emeritus) have been extremely helpful in developing many ideas in this chapter.

References and Notes

1. The generic term “limestone” is used instead of specific varieties of CaCO_3 , such as calcite, aragonite, vaterite, chalk, oolites, pisoliths, travertine, ikaite, and marble.
2. See the description for [Figure 55 on page 124](#).
3. “The Earth is covered by 64% sediments (a third of which are carbonates).” Jens Hartmann and Niles Moosdorf, “The New Global Lithological Map Database GLiM,” *Geochemistry, Geophysics, Geosystems*, Vol. 13, December 2012, p. 1.
4. “*The debate over the role of fluid flow in the precipitation of diagenetic cements is a longstanding one that arose because it is often difficult to find a sufficient local source of cement to account for observed cement volumes, and it is equally difficult to justify the large volume of pore waters required to transport the necessary chemical components from distant sources. The debate has been particularly heated in cases where cement sources and sinks are not readily apparent. ... Was large-scale fluid flow required, or was temperature the dominant factor, with silica being locally redistributed from sources not immediately obvious from petrographic examination?*” Lori L. Summa, “Diagenesis and Reservoir Quality Prediction,” *Reviews of Geophysics and Space Science*, Vol. 33, February 1995, p. 88.

Note: A very large amount of water was involved (a global flood), and the source of the silica was quartz dissolved in extremely hot, subterranean supercritical water. (Granite contains about 27% quartz by volume.) This solves the “quartz problem.”
5. Jeffrey S. Hanor, “Precipitation of Beachrock Cements: Mixing of Marine and Meteoric Waters vs. CO_2 -Degassing” *Journal of Sedimentary Petrology*, Vol. 48, June 1978, pp. 489–501.
6. This reaction, in either direction, is accompanied by a small heat effect (± 4.34 Kcal/mole at 25°C and 1 atmosphere) and thus is relatively insensitive to temperature change. While the reaction changes from endothermic to exothermic with increasing temperature, the escape of CO_2 from an aqueous to a gas phase is always endothermic and hence is always favored by increasing temperature. C. Stuart Patterson, Personal communication, 2 November 1999.
- ◆ C. S. Patterson et al., “Carbonate Equilibria in Hydrothermal Systems: First Ionization of Carbonic Acid in NaCl Media to 300°C ,” *Geochimica et Cosmochimica Acta*, Vol. 46, 1982, pp. 1653–1663.
- ◆ C. S. Patterson et al., “Second Ionization of Carbonic Acid in NaCl Media to 250°C ,” *Journal of Solution Chemistry*, Vol. 13, No. 9, 1984, pp. 647–661.
7. This balance between the partial pressure of each gas in the atmosphere and the concentration of that gas in Earth’s surface waters is called *Henry’s Law*.
8. Gordon A. Macdonald, *Volcanoes* (Englewood Cliffs, New Jersey: Prentice-Hall, Inc., 1972), p. 50.
9. P. Falkowski et al., “The Global Carbon Cycle: A Test of Our Knowledge of Earth as a System,” *Science*, Vol. 290, 13 October 2000, p. 293.
- ◆ Other estimates, consistent with the above, can be found in:
 - ◆ U. Siegenthaler and J. L. Sarmiento, “Atmospheric Carbon Dioxide and the Ocean,” *Nature*, Vol. 365, 9 September 1993, pp. 119–125.
 - ◆ Bert Bolin, *The Global Carbon Cycle* (New York: John Wiley & Sons, 1979), p. 5.
 - ◆ Bert Bolin, “The Carbon Cycle,” *Scientific American*, Vol. 223, March 1970, pp. 125–132.
10. Michael Rubner, “Synthetic Sea Shell,” *Nature*, Vol. 423, 26 June 2003, pp. 925–926.
11. Marilyn Taylor, “Descent,” *Arizona Highways*, Vol. 69, January 1993, pp. 10–11.
12. Arthur N. Strahler, *Physical Geology* (New York: Harper & Row, Publishers, 1981), p. 247.
13. As a hydroplate approached and even scraped along the chamber floor, the eroding power of the escaping waters beneath it reached a maximum. [See Endnote 70 on page 145.] When the plates approached their present location, the last waters to escape would, therefore, have carried the greatest load of suspended solids. So, the last material expelled was a huge slurry of water-saturated limestone.
14. “*Prior to 1964, dolomite was unknown as a significant deposit in Holocene [recent] sediments and a major concern of sedimentologists was ‘The Dolomite Problem’.*” Harvey Blatt, *Sedimentary Petrology* (New York: W. H. Freeman and Co., 1982), p. 332.
15. “*Dolomite ... poses a problem of origin, because the mineral is not secreted by organisms as shell material. Direct precipitation from solution in seawater is not considered adequate to explain the great thicknesses of dolomite rock that are found in the geologic record.*” Strahler, pp. 117–118.
16. Blatt, pp. 306, 307, 316.
17. Anne C. Sigleo, “Organic Geochemistry of Silicified Wood, Petrified Forest National Park, Arizona,” *Geochimica et Cosmochimica Acta*, Vol. 42, September 1978, pp. 1397–1405.
18. Carleton Moore as reported at www.cnn.com on 23 June 2000. (See also: www.chron.com/content/interactive/space/astronomy/news/2000/solarsys/20000623.html.) For details, see Douglas J. Sawyer et al., “Water Soluble Ions in the Nakhla Martian Meteorite,” *Meteoritics & Planetary Science*, Vol. 35, July 2000, pp. 743–747.
19. “*The primary observation is that the suite of species found in Nakhla [this meteorite] is similar to most common ions present in contemporary terrestrial seawater In addition, the relative magnitude of the species is similar to that of seawater, except for the amount of calcium cation (Ca^{2+}), carbonate, and the silicate anion. These are unexpectedly high ...*” Ibid., p. 745.
20. Ibid., p. 744.



Figure 155: Berezovka Mammoth. This is the most famous of all mammoths, the frozen Berezovka (bear-uh-ZOVE-kuh) mammoth. He is displayed in the Zoological Museum in St. Petersburg, Russia, in the struggling position in which he was found near Siberia's Berezovka River, just inside the Arctic Circle. His trunk and much of his head, reconstructed in this display, had been eaten by predators before scientists arrived in 1901. After a month of excavation, ten pony-drawn sleds hauled most of his cut-up carcass more than 2,000 miles south to the Trans-Siberian Railroad. From there he was taken to St. Petersburg's Zoological Museum, today's leading institution for studying frozen mammoths. The handle (extreme bottom center) of the shovel used in the excavation provides the scale. Inches above the handle is Berezovka's extended and flattened penis. While in the museum, I saw this reproductive organ's condition and realized that it helps explain how Berezovka and other frozen mammoths died.

Figure 156: Dima, Baby Mammoth (right). In 1977, the first complete baby mammoth was found—a 6–12-month-old male named "Dima." His flattened, emaciated, but well-preserved body was encased in a lens of ice, 6 feet below the surface of a gentle mountainous slope.¹ Portions of the ice were clear and others quite brownish yellow with mineral and organic particles.² Silt, clay, and small particles of gravel were found throughout his digestive and respiratory tracts (trachea, bronchi, and lungs). These details are important clues in understanding frozen mammoths.

Most mammoths were fat and well fed, but before being frozen, Dima may have suffered from one of the many problems common to baby elephants. (Within their first year of life, up to 36% of elephants die.³)



Frozen Mammoths

SUMMARY: *Muddy water from the fountains of the great deep jetted above the atmosphere where it froze into extremely cold hail. Within hours, mammoths, which could not have lived in today's Arctic climates or at Arctic latitudes, were buried alive and quickly frozen as some of this muddy hail fell back to Earth in a gigantic hail storm. (As Endnote 84 on page 148 explains, latitudes changed soon after the flood.) Past attempts to explain the frozen mammoths ignored many established facts.*

For centuries, stories have been told of frozen carcasses of huge, elephant-like animals called *mammoths*,⁴ buried in the tundra of northeastern Siberia.⁵ These mammoths, with curved tusks sometimes more than 13 feet long, were so fresh-looking that some believed they were simply large moles living underground. Some called them “ice-rats.”⁶ People thought that when mammoths surfaced and saw daylight, they died. Dr. Leopold von Schrenck, Chief of the Imperial Academy of Sciences at Petrograd (today's St. Petersburg, Russia), published the following account in 1869: “The mammoth ... is a gigantic beast which lives in the depths of the Earth, where it digs for itself dark pathways, and feeds on earth ... They account for its corpse being found so fresh and well preserved on the ground that the animal is still a living one.”⁷ Some even thought that rapid tunneling by mammoths produced earthquakes.⁸

This was an early explanation for the frozen mammoths. As people learned other strange details, theories multiplied. Unfortunately, theories that explained some details could not explain others. Some explanations, such as the one above, appear ludicrous today.

To learn what froze the mammoths, we must first understand much of what is known about them. This is

summarized immediately below. Then, we will distill the key details requiring an explanation. Finally, we will examine ten proposed theories. Initially, many may seem plausible, but their flaws will become apparent when we systematically compare how effectively they explain each detail. We will see that the hydroplate theory, summarized on pages 111–151, best explains all the details.

General Description

What Is Found. Since 1800, at least 11 scientific expeditions have excavated fleshy remains of extinct mammoths.⁹ Most fleshy remains were buried in the permafrost of northern Siberia, inside the Arctic Circle. The remains of six mammoths have been found in Alaska. Only a few complete carcasses have been discovered. Usually, wild animals had eaten the exposed parts before scientists arrived.

If we look in the same region for frozen soft tissue of other animals, we learn that several rhinoceroses have been found, some remarkably preserved. (Table 10 on page 269 summarizes 57 reported mammoth and rhinoceros discoveries.) Other fleshy remains come from a horse,¹⁰ a young musk ox,¹¹ a wolverine,¹² voles,¹³ squirrels, a bison,¹⁴ a rabbit, and a lynx.¹⁵

If we now look for the bones and ivory of mammoths, not just preserved flesh, the number of discoveries becomes enormous, especially in Siberia and Alaska. Nikolai Vereshchagin, Chairman of the Russian Academy of Science's Committee for the Study of Mammoths, estimated that more than half a million tons of mammoth tusks were buried along a 600-mile stretch of the Arctic coast.¹⁶ Because the typical tusk weighs 100 pounds, this implies that about 5 million mammoths lived in this small region.

Frozen Mammoths

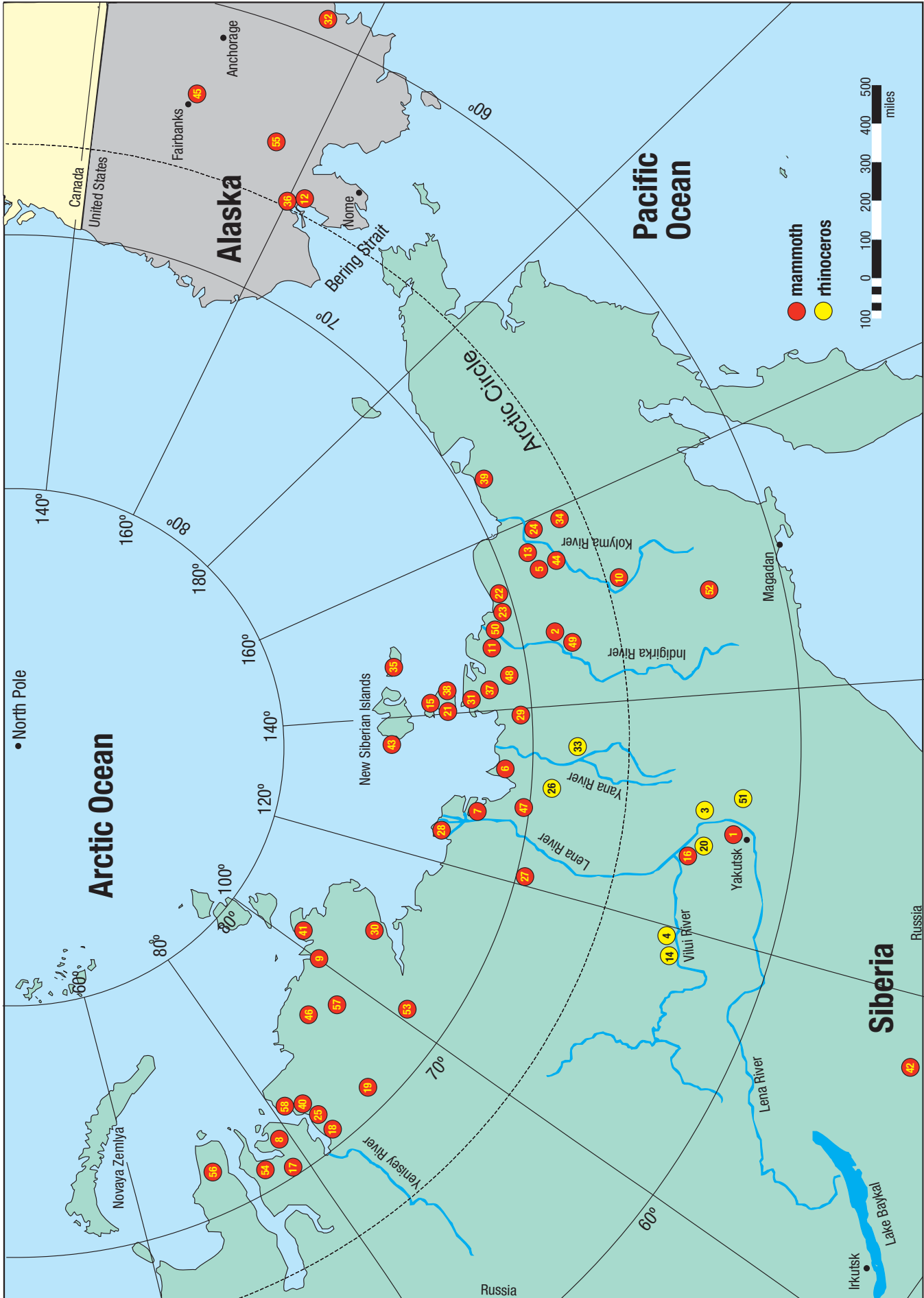

Figure 157: Map of Frozen Mammoth and Rhinoceros Finds. Circled numbers refer to rows in Table 10.

Table 10. Reports of Frozen Mammoths and Rhinoceroses

	Date ^a	Name ^b	Description (Pertains to mammoths unless stated otherwise.)	Reference ^c
1	1693 ^d	Ides	frozen head and leg ^e	Ides, 25–27
2	1723	Messerschmidt	frozen head and big pieces of skin with long hair	Breyne, 138
3	1739	Laptev	several rhinoceros heads	T, 22
4	1771	Pallas	complete rhinoceros; suffocated; hairy head and two feet recovered	Eden; ¹⁷ H, 44, 82, 184
5	1787	Sarychev	complete when first seen; upright ^e	H, 82–83; T, 23
6	1800	Potapov	“on the shores of the Polar Sea”; skin and hair recovered	T, 25
7	1805	Adams	complete when first seen; 70-year-old male; 35,800 RCY; upright ^e	T, 23–25; H, 83–85
8	1839	Trofimov	complete; in a river bank; hair, bones, pieces of flesh and brain recovered	H, 85; T, 26
9	1843	Middendorff	a half-grown mammoth; most of its flesh had decayed, eyeball recovered	H, 85–86; Eden, 104
10	1845 ^d	Khitrof	well preserved when found; food between teeth	H, 86
11	1846	Benkendorf	complete; upright; see page 272	HD, 32–38; D, 97–103
12	1847 ^d	Goodridge	AK; “a skull with a quantity of hair”	Maddren ¹⁸
13	1854	Khitrovo	a foot covered with hair; from a mammoth in good condition	T, 27
14	1858	Vilui	rhinoceros; a complete skeleton with some ligaments	T, 27
15	1860	Boyarski	upright in the face of an island’s coastal cliff	T, 32
16	1861 ^d	Golubef	“a huge beast covered with skin” in a river bank	H, 86
17	1864	Schmidt-1	PC; only skin and hair recovered a year later	T, 28; D, 108–110
18	1865	Koschkarof	PC; largely decomposed a year later	H, 86–87
19	1866	Schmidt-2	recovered on a lake shore; bones and hair of various lengths	T, 28; P, 8
20	1866	Kolesov	a large mammoth or rhinoceros, covered with skin	T, 27
21	1866	Bunge-1	“pieces of skin and plenty of hair”	T, 32
22	1869	Von Maydell-1	PC; upright; three years later, only a large hairy hide recovered	D, 80–95; H, 87–89
23	1869	Von Maydell-2	PC; only two legs found a year later	D, 80–95; H, 87–89
24	1870	Von Maydell-3	PC; only a leg was recovered three years later	D, 80–95; H, 87–89
25	1876	Nordenskiold	inch-thick hide near skull of a musk sheep	Nordenskiold, 310; H, 89
26	1877	Von Schrenck	complete rhinoceros; the head was thoroughly studied; apparent suffocation	H, 89; T, 30–31
27	1879	Bunge-2	tusks chopped off; reported to authorities four years later	T, 31
28	1884	Bunge-3	PC; first seen by natives 27 years earlier; two-inch-thick skin claimed	T, 16, 31
29	1886	Toll-1	23 years after natives’ discovery, a few soft parts and hair were recovered	T, 32
30	1889	Burimovitch	reportedly complete; Toll’s bad health prevented him from reaching the site	T, 33
31	1893	Toll-2	damaged bones, hairy skin, and other hair	T, 33
32	1894	Dall	AK; disintegrated muscle tissue, bones, and 300 pounds of fat	Dall ¹⁹
33	1901	Pfizenmayer	rhinoceros; “a few fragments of ligaments and other soft parts”	P, 53–54; T, 35
34	1901	Berezovka	almost complete; upright; late summer death; 44,000 RCY; see page 273	HE, 611–625; D, 111–136
35	1902	Brusnev	hair recovered, mixed with mud	T, 36
36	1908	Quackenbush	AK; pieces of flesh; tendons, skin, tail, and hair recovered	A, 299; Q, 107–113
37	1908	Vollosovitch-1	small female; pieces scattered; died at end of summer; 29,500 and 44,000 RCY	P, 146–164; D, 211–212
38	1910	Vollosovitch-2	late summer death; well-preserved eye, four legs, trunk, food in stomach	P, 241–246; T, 37–38
39	1910	Soloviev	PC; young mammoth; reported to but not pursued by scientists	T, 39
40	1913	Goltchika	PC; “dogs and foxes got at it and ate pretty well all the lot”	T, 38; D, 212
41	1915	Transehe	PC; found in 30- to 50-foot cliff on the Arctic Ocean; never excavated	T, 39; Transehe ²⁰
42	1922	Kara	carcass reported to scientists, but only hard parts remained four years later	T, 39–40
43	1923	Andrews	ivory traders sold skull still containing ligaments to British museum	T, 39
44	1924	Middle Kolyma	scrap of trunk remained; no record of original discovery	VT, 19; G, 26
45	1948	Fairbanks Creek	AK; 200-pound, 6-month-old; head, trunk, and one leg; 15,380 RCY and 21,300 RCY	A, 299–300; G, 38–41
46	1949	Taimir	50-year-old male; tendons (11,500 RCY), hair, and an almost complete skeleton	VT, 20; Lister and Bahl ²¹
47	1960	Chekurov	carcass of a young female; very small tusks; hair dated at 26,000 RCY	Vinogradov ²²
48	1970	Berelekh	a cemetery of at least 156 mammoths; minor hair and flesh remains	U, 134–148; S, 66–68
49	1971	Terektyakh	pieces of muscle, ligament, and skin; some around head	S, 67
50	1972	Shandrin	old; 550 pounds of internal organs and food preserved; 32,000 RCY and 43,000 RCY	U, 67–80; G, 27–29
51	1972	Churapachi	old rhinoceros, probably a female; “lower legs were in fair condition”	G, 34–37
52	1977	Dima	complete; 6-to-8-month-old male; 26,000 RCY and 40,000 RCY; see page 266	G, 7–24; U, 40–67
53	1978	Khatanga	55- to 60-year-old male; left ear, two feet; trunk in pieces; 45,000 RCY and 53,000 RCY	U, 30–40; G, 24–27
54	1979	Yuribei	12-year-old female; green-yellow grass in stomach; hind quarters preserved	U, 12–13, 108–134; VT, 22
55	1983	Colorado Creek	AK; two males; bones, hair, and gut contents recovered; 16,150 RCY and 22,850 RCY	Thorson and Guthrie ²³
56	1988	Mascha	3- to 4-month-old female; complete except for trunk, tail, and left ear; found in the Yamal Peninsula	LB, 46–47; VT, 25
57	1999	Jarkov	fragments of a 47-year-old male; removed in a 23-ton block of permafrost by helicopter	Stone ²⁴
58	2012	Zhenya	15-year-old male, 1100 pounds, died in summer, right half of body well preserved (organs, skin, tusk)	Moscow News, 17 Oct. 2012

Some references in the right column are abbreviated: A=Anthony, D=Digby, G=Guthrie, H=Howorth, HD=Hornaday, HE=Herz, LB=Lister and Bahl, P=Pfizenmayer, Q=Quackenbush, S=Stewart, 1977, T=Tolmachoff, U=Ukrainitseva, VT=Vereshchagin and Tikhonov. Page numbers follow each abbreviation. See endnotes for complete citation. Other abbreviations are AK=found in Alaska, PC=possibly complete when first seen, RCY=radiocarbon years (most radiocarbon ages are from VT: 17–25).

Footnotes: a. Usually the year of excavation. First sighting often occurred earlier. b. The name given is usually the discoverer’s, a prominent person involved in reporting the discovery, or a geographical name, such as that of a river. c. No more than the two best references are given. The more detailed reference is listed first. d. An approximate date. e. Referred to other carcasses but details are lacking.

Even if this estimate is high or represents thousands of years of accumulation, we can see that large herds of mammoths must have thrived along what is now the Arctic coast. Mammoth bones and ivory are also found in Europe, North and Central Asia, and in North America, as far south as Mexico City.

Dense concentrations of mammoth bones, tusks, and teeth are also found on remote Arctic islands. Obviously, today's water barriers were not always there. Many have described these mammoth remains as the main substance of the islands.²⁵ What could account for any concentration of bones and ivory on barren islands well inside the Arctic Circle? Also, more than 200 mammoth molars were dredged up along with oysters from the Dogger Bank in the North Sea.²⁶

The northern portions of Europe, Asia, and North America contain bones of many other animals along with those of mammoths. A partial listing includes tiger,²⁷ antelope,²⁸ camel, horse, reindeer, giant beaver, fox, giant bison, giant ox, musk sheep, musk ox, donkey, badger, ibex, woolly rhinoceros, lynx, leopard, wolverine, Arctic hare, lion, elk, giant wolf, ground squirrel, cave hyena, bear, and many types of birds. Friend and foe, as well as young and old, are found together. Carnivores are sometimes buried with herbivores. Were their deaths related? Rarely are animal bones preserved; preservation of so many different types of animal bones suggests a common explanation.

Finally, corings 100 feet into Siberia's permafrost, have recovered sediments mixed with ancient DNA of mammoths, bison, horses, other temperate animals, and the lush vegetation they require. Nearer the surface, these types of DNA are absent, but DNA of meager plants able to live there today is present.²⁹ The climate must have suddenly and permanently changed to what it is today.

Mammoth Characteristics and Environment. The common misconception that mammoths lived in areas of extreme cold comes primarily from popular drawings of mammoths living comfortably in snowy, Arctic regions. The artists, in turn, were influenced by earlier opinions based on the mammoth's hairy coat, thick skin, and a 3.5-inch layer of fat under the skin. However, animals with these characteristics do not necessarily live in cold climates. Let's examine these characteristics more closely.

Hair. The mammoth's hairy coat no more implies an Arctic adaptation than a woolly coat does for a sheep. Mammoths lacked erector muscles that fluff up an animal's fur and create insulating air pockets. Neuville, who conducted the most detailed study of mammoth skin and hair, wrote: "It appears to me impossible to find, in the anatomical examination of the skin and pelage [hair], any argument in favor of

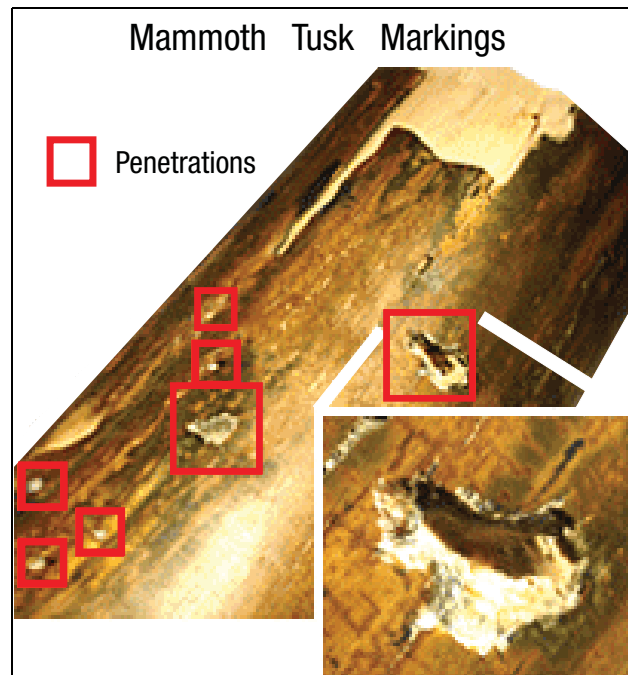

Figure 158: Peppered Mammoth Tusk. Scientists are finding, over wide geographical areas, mammoth tusks embedded on one side with millimeter-size particles rich in iron and nickel. This has led some to wonder if meteorites exploding high in the atmosphere punctured those tusks.³² The British Broadcasting Corporation stated, "Startling evidence has been found which shows mammoth and other great beasts from the last ice age were blasted with material that came from space."³³ But is that the whole story?

adaptation to the cold."³⁰ Long hair on a mammoth's legs hung to its toes.³¹ Had it walked in snow, snow and ice would have caked on its hairy "ankles." Each step into and out of snow would have pulled or worn away the "ankle" hair. All hoofed animals living in the Arctic, including the musk ox, have fur, not hair, on their legs.³⁴ Fur, especially oily fur, holds a thick layer of stagnant air (an excellent insulator) between the snow and skin. With the mammoth's greaseless hair, much more snow would touch the skin, melt, and increase the heat transfer 10-to-100 fold. Later refreezing would seriously harm the animal.

Skin. Mammoth and elephant skin are similar in thickness and structure.³⁵ Both lack oil glands, making them vulnerable to cold, damp climates. Arctic mammals have both oil glands and erector muscles—equipment absent in mammoths.³⁶

Fat. Some animals living in temperate or even tropical zones, such as the rhinoceros, have thick layers of fat, while many Arctic animals, such as reindeer and caribou, have little fat. Thick layers of fat under the skin simply show that **food was plentiful**. Abundant food implies a temperate climate.



Figure 159: Fossil Forest, New Siberian Islands. Vast, floating remains of forests have washed up on the New Siberian Islands, well inside the Arctic Circle and thousands of miles from comparable forests today. This driftwood was washed ashore on Bolshoi Lyakhov Island, one of the New Siberian Islands. The wood was probably buried under the muck that covers northern Siberia. Later, northward flowing Siberian rivers, during early summer flooding, eroded the muck, releasing the buried forests. “Fossil wood,” as it is called, is a main source of fuel and building material for many Siberians.

Elephants. The elephant, which is closely related to the mammoth,³⁷ lives in tropical or temperate regions, not the Arctic. It requires a climate that ranges from warm to hot, and “it gets a stomach ache if the temperature drops close to freezing.”³⁸ Newborn elephants are susceptible to pneumonia and must be kept warm and dry.³⁹ Hannibal crossed the Alps with 37 elephants; the cold weather killed all but one.⁴⁰

Water. If mammoths lived in an Arctic climate, their drinking water in the winter must have come from eating snow or ice. A wild elephant requires 30–60 gallons of water each day.⁴¹ The heat needed to melt snow or ice and warm it to body temperature would consume about half a typical elephant’s calories. The mammoth’s long, vulnerable trunk would bear much of this thermal (melting) stress. Nursing elephants require about 25% more water.

Salt. How would a mammoth living in an Arctic climate satisfy its large salt appetite? Elephants dig for salt using their sharp tusks.⁴² In rock-hard permafrost this would be almost impossible, summer or winter, especially with curved tusks.

Nearby Plants and Animals. The easiest and most accurate way to determine an extinct animal’s or plant’s environment is to identify familiar animals and plants buried nearby. For the mammoth, this includes rhinoceroses, tigers, horses, antelope,⁴³



Figure 160: Fossil Forest, Kolyma River. Here, driftwood is at the mouth of the Kolyma River, on the northern coast of Siberia. Today, no trees of this size grow along the Kolyma. Leaves, and even fruit (plums), have been found on such floating trees.⁴⁴ One would not expect to see leaves and fruit if these trees had been carried far by rivers. Why didn’t these trees decay?

bison, and temperate species of grasses. All live in warm climates. Some burrowing animals are frozen, such as voles, which would not burrow in rock-hard permafrost. Even larvae of the warble fly have been found in a frozen mammoth’s intestine—larvae identical to those found in tropical elephants today.⁴⁵ No one argues that animals and plants buried near the mammoths were adapted to the Arctic. Why do so for mammoths?

Temperature. The *average* January temperature in northeastern Siberia is about -28°F (60°F below freezing)! During the Ice Age, it was even colder. The long, slender trunk of the mammoth was particularly vulnerable to cold weather. A six-foot-long nose could not survive even one cold night, let alone an eight-month-long Siberian winter or a sudden cold snap. For the more slender trunk of a young mammoth, the heat loss would be more deadly. An elephant usually dies if its trunk is seriously injured.⁴⁶

No Winter Sunlight. Cold temperatures are one problem, but six months of little sunlight during Arctic winters is quite another. While some claim that mammoths were adapted to the cold environment of Siberia and Alaska, vegetation, adapted or not, does not grow during the months-long Arctic night. In those regions today, vegetation is covered by snow and ice ten months each year. Mammoths had to eat voraciously. Elephants in the wild spend about 16 hours a day foraging for food in relatively lush environments, summer *and* winter.⁴⁷

Three Problems. Before examining other facts, we can see three curious problems. First, northern Siberia today is cold, dry, and desolate. Vegetation does not grow during dark Arctic winters. How could millions of mammoths and other animals, such as rhinoceroses, horses, bison, and antelope, feed themselves? But if their environment were more temperate and moist, why did it change?

Second, the well-preserved mammoths and rhinoceroses must have been completely frozen soon after death or their soft internal parts would have quickly decomposed. Guthrie has written that an unopened animal continues to decompose long after a fresh kill, even in very cold temperatures, because its internal heat can sustain microbial and enzyme activity as long as the carcass is completely covered with an insulating pelt.⁴⁸ Because mammoths had such large reservoirs of body heat, the freezing temperatures must have been extremely low.

Finally, their bodies were buried and protected from predators, including birds and insects. Such burials could not have occurred if the ground were perpetually frozen as it is today. Again, this implies a major climate change, but now we can see that it must have changed dramatically and suddenly. How were these huge animals quickly frozen and buried—almost exclusively in **muck**, a dark soil containing decomposed animal and vegetable matter?

Muck. Muck is a major geological mystery. It covers one-seventh of the Earth's land surface—all surrounding the Arctic Ocean. Muck occupies treeless, generally flat terrain, with no surrounding mountains from which the muck could have eroded. Russian geologists have drilled through 4,000 feet of this muck without hitting solid rock. Where did so much eroded material come from? What eroded it?

Oil prospectors, drilling through Alaskan muck, have “brought up an 18-inch-long chunk of tree trunk from almost 1,000 feet below the surface. It wasn't petrified—just frozen.”⁴⁹ The nearest forests are hundreds of miles away. Williams describes similar discoveries in Alaska:

*Though the ground is frozen for 1,900 feet down from the surface at Prudhoe Bay, everywhere the oil companies drilled around this area they discovered an ancient tropical forest. It was in frozen state, not in petrified state. It is between 1,100 and 1,700 feet down. There are palm trees, pine trees, and tropical foliage in great profusion. In fact, they found them lapped all over each other, just as though they had fallen in that position.*⁵⁰

How were trees buried under a thousand feet of hard, frozen ground? We are faced with the same series of questions we first saw with the frozen mammoths. Again, it seems there was a sudden and dramatic freezing accompanied by rapid burial in muck, now frozen solid.

Some Specifics

We cannot minimize the frozen mammoth mystery by saying, “Only a few complete mammoths have been reported.” One good case would be enough. Undoubtedly, hundreds of past discoveries went unreported, because many Siberians believed that looking at a mammoth's face brought death or misfortune. Fear of being forced by scientists to dig a mammoth out of frozen ground suppressed other discoveries. Also, Siberia and Alaska are sparsely populated and relatively unexplored. Flowing rivers are the primary excavators, so man has seen only a tiny sample of what is buried. Siberian geologists report that “work at the gold mines uncovers frozen corpses every year, but because the arrival of scientists can delay and complicate the mining, most [frozen mammoths] are lost to science.”⁵¹

Widespread freezing and rapid burial are also inferred when commercial grade ivory is found. Ivory tusks, unless frozen and protected from the weather, dry out, lose their animal matter and elasticity, crumble, crack, and become useless for carving.⁵² Between about 1750 and 1917, trade in mammoth ivory prospered over a wide geographical region, yielding an estimated 96,000 mammoth tusks.⁵³ The extent and speed of freezing and burial was probably greater than most people have imagined.



Figure 161: Depiction of the Recovery of the Benkendorf Mammoth.

The Benkendorf Mammoth.⁵⁴ In May 1846, a surveyor named Benkendorf and his party camped along Siberia's Indigirka River. The spring thaw and unusually heavy rains caused the swollen river to erode a new channel. Benkendorf noticed a large object bobbing slowly in the water. As the “black, horrible, giantlike mass was thrust out of the water [they] beheld a colossal elephant's head, armed with mighty tusks, with its long trunk moving in an unearthly manner, as though seeking something lost therein.” They tried to pull the mammoth to shore with

ropes and chains but soon realized that its hind legs were frozen in the river bottom *in a standing position*.

Twenty-four hours later, the river bottom thawed and eroded, freeing the mammoth. A team of 50 men and their horses pulled the mammoth onto dry land, 12 feet from shore. The 13-foot-tall, 15-foot-long beast was fat and perfectly preserved. Its “widely opened eyes gave the animal an appearance of life, as though it might move in a moment and destroy [them] with a roar.” They removed the tusks and opened its *full* stomach containing “young shoots of the fir and pine; and a quantity of young fir cones, also in a chewed state ...” Hours later and without warning, the river bank collapsed, because the river had slowly undercut the bank. The mammoth was carried off toward the Arctic Ocean, never to be seen again.

The Berezovka Mammoth. The most famous, accessible, and studied mammoth is a 50-year-old⁵⁵ male, found in a freshly eroded bank, 100 feet above Siberia’s Berezovka River in 1900. A year later an expedition, led by Dr. Otto F. Herz, painstakingly excavated the frozen body and transported it to the Zoological Museum in St. Petersburg, Russia.⁵⁶ [See [Figure 155 on page 266](#).]

Berezovka was upright, although his back was excessively humped and his straightened hind legs were rotated forward at the hips into an almost horizontal position. This strange, contorted position was further exaggerated by his raised and spread front legs. Several ribs, a shoulder blade, and pelvis were broken.⁵⁷ Amazingly, the long bone in his right foreleg was crushed into about a dozen pieces, without noticeably damaging surrounding tissue.⁵⁸ “There had been considerable bleeding between the muscles and the fatty and connective tissues.”⁵⁹ His shaggy, wirelike hair, some of it 20 inches long, was largely intact.⁶⁰ His erect penis was horizontally flattened.⁶¹ (This organ in a live elephant is round, S-shaped, and never horizontal.)⁶²

What can we conclude from these unusual details? To crush a slender rod, which the long leg bones resemble, requires axial compression while the rod (or bone) is encased in some material that prevents bending and snapping. To demonstrate this, place a long, straight stick vertically on a table and see how difficult it is to compress and break it into a dozen or so pieces. Instead, it will snap at the weakest point. If the stick has a slight bend, as do the long leg bones, crushing becomes almost impossible. Something must prevent the stick or bone from bending as the compressive load increases. Evidently, Berezovka’s leg bone was severely compressed lengthwise while rigidly encased.⁶³ The “considerable bleeding” shows that this crushing occurred before or soon after death.

Slow suffocation of males can produce penile erection.⁶⁴ Tolmachoff concluded that, “The death [of Berezovka] by

suffocation is proved by the erected male genital, a condition inexplicable in any other way.”⁶⁵ But why was the penis horizontally flattened? It had to be pressed between two horizontal surfaces, one of which was probably his abdomen. Again, considerable vertical compression must have acted within some medium encasing the entire body.

Suffocation is also implied with four other frozen giants. Vollosovitch ([Table 10](#)) concluded that his second buried mammoth, found with a penile erection on Bolshoi Lyakhov Island, had suffocated.⁶⁶ A third example is provided by Dima, whose “pulmonary alveoli suggested death by asphyxia” after “great exertion just before death.”⁶⁷ The Pallas rhinoceros also showed symptoms of asphyxiation.

*The blood-vessels and even the fine capillaries were seen to be filled with brown coagulated blood, which, in many places still preserved its red colour. This is exactly the kind of evidence we look for when we want to know whether an animal has been drowned or suffocated. Asphyxia is always accompanied by the gorging of the capillaries with blood.*⁶⁸

Von Schrenck’s rhinoceros was found with expanded nostrils and an open mouth. Investigators concluded, “that the animal died from suffocation, which it tried to avoid by keeping the nostrils wide asunder.”⁶⁹ In all, three mammoths and two rhinoceroses apparently suffocated. No other cause of death has been shown for the remaining frozen giants.⁷⁰

Sanderson describes another strange aspect of Berezovka.

*Much of the head, which was sticking out of the bank, had been eaten down to the bone by local wolves and other animals, but most of the rest was perfect. Most important, however, was that the lips, the lining of the mouth and the tongue were preserved. Upon the last, as well as between the teeth, were portions of the animal’s last meal, which for some almost incomprehensible reason it had not had time to swallow. The meal proved to have been composed of delicate sedges and grasses ...*⁷¹

Another account states that the mammoth’s “mouth was filled with grass, which had been cropped, but not chewed and swallowed.”⁷² The grass froze so rapidly that it still had “the imprint of the animal’s molars.”⁷³ Hapgood’s translation of a Russian report mentions eight well-preserved bean pods and five beans found in its mouth.⁷⁴

Twenty-four pounds of undigested vegetation were removed from Berezovka and analyzed by Russian scientist V. N. Sukachev. He identified more than 40 different species of plants: herbs, grasses, mosses, shrubs, and tree leaves. Many no longer grow that far north; others grow both in Siberia and as far south as Mexico. Dillow⁷⁵ draws several conclusions from these remains:

- ◆ *The presence of so many varieties [of plants] that generally grow much to the south indicates that the climate of the region was milder than that of today.*
- ◆ *The discovery of the ripe fruits of sedges, grasses, and other plants suggests that the mammoth died during the second half of July or the beginning of August.*
- ◆ *The mammoth must have been overwhelmed suddenly with a rapid deep freeze and instant death. The sudden death is proved by the unchewed bean pods still containing the beans that were found between its teeth, and the deep freeze is suggested by the well-preserved state of the stomach contents and the presence of edible meat [for wolves and dogs].*

At normal body temperatures, stomach acids and enzymes break down vegetable material within an hour. What inhibited this process? The only plausible explanation is for the stomach to cool to about 40°F in ten hours or less.⁷⁶ But because the stomach is protected inside a warm body (96.6°F for elephants), how cold must the outside air become to drop the stomach's temperature to 40°F? Experiments have shown that the outer layers of skin would have had to drop *suddenly* to at least -175°F!⁷⁷

Independently, Sanderson concluded, "The flesh of many of the animals found in the muck must have been very rapidly and deeply frozen, for its cells had not burst. ... Frozen-food experts have pointed out that to do this, starting with a healthy, live specimen, you would have to suddenly drop the temperature of the surrounding air to well below minus 150 degrees Fahrenheit."⁷⁸

The ice layer directly under the Berezovka mammoth contained some hair still attached to his body. Below his right forefoot was "the end of a very hairy tail ... of a bovine animal, probably [a] bison."⁷⁹ Also under the body were "the right forefoot and left hind foot of a reindeer ... The whole landslide on the Berezovka [River] was the richest imaginable storehouse of prehistoric remains."⁸⁰ In the surrounding, loamy soil was an antelope skull,⁸¹ "the perfectly preserved upper skull of a prehistoric horse to which fragments of muscular fibre still adhered,"⁸² tree trunks, tree fragments, and roots.⁸³ This vegetation differed from the amazingly well-preserved plants in the mammoth's mouth and stomach.

Geographical Extent. We should also notice the broad geographical extent over which these strange events occurred. [See map on page 268.] They were probably not separate, unrelated events. As Sir Henry Howorth stated:

The instances of the soft parts of the great pachyderms being preserved are not mere local and sporadic ones, but they form a long chain of examples along the whole length of Siberia, from the Urals to the land of the Chukchis [the Bering Strait], so that we have to do here with a condition of things which prevails, and with meteorological conditions that extend over a continent.

When we find such a series, ranging so widely, preserved in the same perfect way, and all evidencing a sudden change of climate from a comparatively temperate one to one of great rigour, we cannot help concluding that they all bear witness to a common event. We cannot postulate a separate climate cataclysm for each individual case and each individual locality, but we are forced to the conclusion that the now permanently frozen zone in Asia became frozen at the same time from the same cause.⁸⁴

Actually, northern portions of Asia, Europe, and North America contain "the remains of extinct species of the elephant [mammoth] and rhinoceros, together with those of horses, oxen, deer, and other large quadrupeds."⁸⁵ So, the event may have been even more widespread than Howorth believed.

Rock Ice. In Siberia and Alaska, scientists have found a strange type of ice in and under the muck containing mammoth remains.⁸⁶ Tolmachoff called it *rock ice*.⁸⁷ Rock ice often has a yellow tinge and contains round or elongated bubbles. Some bubbles are connected, while others, an inch or so long, are vertically streaked.⁸⁸ When exposed to the Sun, rock ice showed "a polyhedral, granular structure at the surface, and these granules could usually be easily rubbed off with the finger."⁸⁹ It looked "*like compacted hail*."⁹⁰ Mammoth remains have been found above, below, beside, partially in,⁹¹ and, in one case, within⁹² rock ice.

Horizontal layers of rock ice are most easily seen in bluffs along the Arctic coast and nearby rivers.⁹³ Some subsurface ice layers are more than 2 miles long and 150 feet thick.⁹⁴ A several-foot-thick layer of structureless clay or silt is sometimes above the rock ice. How was this clay or silt deposited? If it settled out of a lake or stream, as normally happens, it should have many thin layers, but it does not. Furthermore, the slow settling of clay and silt through water should have provided enough time for the water to melt all the ice below. Sometimes rock ice contains plant particles⁹⁵ and thin layers of sand or clay. Had the water frozen in a normal way, the dirt would have settled out and the vegetable matter would have floated upward. Obviously, this rock ice froze rapidly and was never part of a lake or stream.

Several feet beneath the Berezovka mammoth was a layer of rock ice, sloping more than 180 feet down to the river. Herz and Pfizenmayer,⁹⁶ after digging into it, reported perhaps the strangest characteristic of rock ice.

Deeper down in the cliff the ice becomes more solid and transparent, in some places entirely white and brittle. After remaining exposed to the air even for a short time this ice again assumes a yellowish-brown color and then looks like the old ice.⁹⁷

Table 11. Characteristics of Rock Ice vs. Three Types of Ice

Some Characteristics of Ice ^a	Type 1: A body of stationary or slowly moving liquid water freezes. Examples: frozen rivers and lakes, ice cubes, subsurface water ^b	Type 2: Water vapor condenses and freezes on microscopic particles in air, forming a type of ice called snow. (Its volume can decrease enormously by compaction, partial melting, and refreezing.) Examples: glaciers, icebergs, ice on winter roads	Type 3: Many small drops of water freeze while moving rapidly through cold air or outer space. Examples: hail, sleet, windblown spray just above a choppy lake	Rock Ice ^c
Bubble Numbers and Sizes	a few the size of a pin head	many tiny air pockets	large pockets trapped between ice particles	many large bubbles ^d
Bubble Percentage	less than 6%	about 6% for glacier ice	much more than 6%	16%
Dissolved Air	saturated	saturated	depends on water source	undersaturated
Granularity	no grains	very tiny grains	very granular	very granular, “like compacted hail” ⁹⁰
Color	usually clear	usually white	depends on the impurities dissolved in the liquid ^e	usually has a yellow tinge
Dirt Content	slight	very little when it first forms	depends on the liquid water’s dirt content ^e	dirt and plant particles easily seen

a. Ice has other characteristics. For example, the atoms in ice can have 15 possible crystalline patterns, depending on the temperature and pressure at which the ice formed. They are called Ice I, Ice II, Ice XV, etc. Unfortunately, the crystallographic structure of rock ice is not yet known. Only the characteristics listed in the table are known for rock ice.

b. Many subsurface ice features are not rock ice: ice wedges, segregated ice (Taber ice), vein ice, pingos, and glaciers covered with dirt. Their characteristics, especially their shapes and sizes, clearly differentiate them from rock ice and show how they formed.

c. For details see Cantwell, “Ice Cliffs,” pp. 345–346; Cantwell, “Exploration,” pp. 551–554; Dall, pp. 107–109; Digby, pp. 93–95, 116, 120–124, 151; Dubrovo, p. 630; Herz, pp. 613, 616, 618, 622; Howarth, p. 53; Maddren, pp. 15, 32, 38–40, 51–54, 58–64, 67–117; Pfizenmayer, 88–90; Quackenbush, pp. 97–103; and Tolmachoff, pp. 51–55.

d. Sometimes these bubbles are connected or form vertical streaks. Their shapes apparently formed over centuries as gravity deformed the ice plastically.

e. Hail, sleet, and ice formed from a lake or ocean spray usually have very little visible dirt or impurities. Ice formed from sprays from other sources might have impurities and color.

Obviously, something in the air (probably oxygen) reacted chemically with something in the ice. Why was air (primarily oxygen and nitrogen) not already dissolved in the ice? Just as liquid water dissolves table salt, sugar, and many other solids, water also dissolves gases in contact with it. For example, virtually all water and ice on Earth are nearly saturated with air. Had air been dissolved in Herz’s rock ice before it suddenly turned yellowish-brown, the chemical reaction would have already occurred.

Table 11 compares the characteristics of rock ice with those of the three generic types of ice. A careful study of this table suggests that rock ice is a Type 3 ice. Because such thick layers of rock ice still exist, an enormous amount of water probably froze while moving through cold air or outer space.

Yedomas and Loess. In Siberia, frozen mammoths are frequently found in strange hills, 30–260 feet high, which Russian geologists call yedomas (yeh-DOME-uhs). For example, the mammoth cemetery, containing remains of 156 mammoths, was in a yedoma.⁹⁸ [See line 48, Table 10, page 269.] It is known that these hills were formed under cold, windy conditions, because they are composed of a powdery, homogeneous soil, honeycombed with thick veins of ice. Sometimes the ice, which several Russian

geologists have concluded was formed simultaneously with the soil, accounts for 90% of the yedoma’s volume.⁹⁹ Some yedomas contain many broken trees “in the wildest disorder.”¹⁰⁰ The natives call them “wood hills” and the buried trees “Noah’s wood.”¹⁰¹ Yedoma soil is similar to muck.¹⁰² It contains tiny plant remains, is high in salt and carbonate,¹⁰³ and has more than two and a half times the carbon that is in all the world’s tropical forests!¹⁰⁴ The Berzovka mammoth was found in a similar soil.¹⁰⁵ This soil has been identified as loess¹⁰⁶ (a German term, pronounced “LERSE”). Little is known about its origin. Most believe it is a windblown deposit spread under cold, glacial conditions over huge regions of the Earth. However, Siberia was scarcely glaciated, and normal winds would deposit loess too slowly to protect so many frozen animals from predators. Loess often blankets formerly glaciated regions, such as Wisconsin, Illinois, Iowa, Kansas, and Alaska. It lacks internal layering (stratification) and is found at all elevations—from just above sea level to hillsides at 8,000 feet elevation. Because loess is at many elevations and its tiny particles are not rounded by thousands of years of exposure to water and wind, some have proposed that loess came recently from outer space.¹⁰⁷ Loess, a fertile soil rich in carbonates, has a yellow tinge caused by the oxidation of iron-bearing minerals after deposition.¹⁰⁸ China’s Yellow River and Yellow Sea are so



Figure 162: A Yedoma. These Siberian hills, called *yedomas*, are honeycombed with ice. The ice and soil layering seen within yedomas (for example, left of the man) suggests that high winds accompanied the deposition of the material. Remains of forests, mammoths, and other animals are frequently found in yedomas.

The ice and mud were not deposited as hills. Instead, they were deposited as one thick layer. Later, as the ice began to melt in spots, water collected in the depressions, accelerating the melting near them. What is now left, after thousands of years of summer melting, are these hills. Because some yedomas are 260 feet tall, the initial deposition in the windy environment was at least 260 feet thick.

named because of the loess suspended in them. Why is there an apparent relationship between frozen mammoths, yedomas, and loess?

Conclusion. This brief survey raises several intriguing but perplexing problems. How could mammoths have lived at Arctic latitudes, especially during the dark winters? What killed them, and how were they buried in such a peculiar manner? Some must have frozen within hours after their deaths, because significant decay or mutilation by scavengers did not occur. However, just before the mammoths were frozen, during that late summer or early fall, conditions in Siberia were not cold. What happened?

Evidence Requiring an Explanation

Summarized below are the hard-to-explain details which any satisfactory theory for the frozen mammoths should explain.

Abundant Food. A typical wild elephant requires about 330 pounds of food per day. Therefore, vast quantities of food were needed to support the estimated 5,000,000 mammoths that lived in just a small portion of northern Siberia. Adams' mammoth, discovered in 1799, "was so fat ... that its belly hung below its knees."¹⁰⁹ How was abundant food available inside the Arctic Circle, especially during winter months when the Sun rarely shines?

Warm Climate. Abundant food requires a temperate climate, much warmer than northern Siberia today—or during the Ice Age. Little of the food found in Berezovka's mouth and stomach grows near the Arctic Circle today. Furthermore, the flower fragments in its stomach show that it died during warm weather. Despite the popular misconception, the mammoth was a temperate—not an Arctic—animal.

Away From Rivers. Although most frozen remains are found along river banks where excavations naturally occur, some frozen remains are found far from rivers.

Yedomas and Loess. Frozen mammoths are frequently found in yedomas and loess. What accounts for this and the strange properties of yedomas and loess? What is the source of so much loess?

Elevated Burials. Mammoth and rhinoceros bodies are often found on the highest levels of generally flat, low plateaus.¹¹⁰ Examples include dense concentrations of mammoth and rhinoceros remains in yedomas and the interior of Arctic islands. Dima was discovered in a mountainous region.

Multi-Continental. Soft parts of large animals have been preserved over a 3,000-mile-wide zone involving three continents (Asia, Europe, and North America). It is unlikely that so many unrelated local events would produce such similar results over such a broad geographical area.

Rock Ice. Strange, granular, Type 3 ice containing clay, sand, and a large volume of air pockets is sometimes found near frozen mammoths. [See [Table 12](#) on page 281.]

Frozen Muck. Mammoth carcasses are almost exclusively encased in frozen muck.¹¹¹ Also buried in muck are huge deposits of trees and other animal and vegetable matter. The origin of muck is a mystery.



Figure 163: Extensive Loess Deposits. Another property of loess is its ability to maintain a vertical cliff. This is seen here in agricultural terraces in northern China, south of Huang Ho. Some historians maintain that the loess deposits helped establish early Chinese civilization, because the fertility of loess soil allows two or three crops a year—without fertilizers. Homes, even furniture, have been carved out of loess hillsides, sometimes 200 feet underground. Entire villages are cut into loess cliffs. Several million people have lived in loess dwellings. While such homes are cheap, insulated, militarily defensible, and may last for generations, they are unstable and dangerous. For example, 180,000 died in the 1920 Kansu earthquake, primarily from the collapse of loess dwellings.¹¹³

Sudden Freezing. Some frozen mammoths and rhinoceroses had food preserved in their mouths, stomachs, or intestines.¹¹²

Suffocation. At least three mammoths and two rhinoceroses suffocated. No other cause of death has been established for the remaining frozen giants.

Dirty Lungs. Dima's respiratory and digestive tract contained silt, clay, and small particles of gravel. Just before he died, Dima breathed air and/or ate food containing such matter.

Peppered Tusks. Why, over wide geographical areas, did millimeter-size particles (rich in iron and nickel) become embedded in one side of some mammoth tusks?

-150°F. Temperatures surrounding some mammoths must have plunged below -150°F.

Large Animals. Most frozen remains are from the larger, stronger animals, such as mammoths and rhinoceroses.

Summer-Fall Death. Vegetation in the stomachs and intestines of preserved mammoths implies that they died in late summer or early fall,¹¹⁴ perhaps in August¹¹⁵ or even late July.¹¹⁶

Animal Mixes. Bones of many types of animals, friends and foes, are frequently found near the mammoths.

Upright. Several frozen mammoths, and even mammoth skeletons,¹¹⁷ were found upright. Despite this posture, the Berezovka mammoth had a broken pelvis and shoulder blade, and a crushed leg. Surprisingly, he was not lying on his side in a position of agony.

Vertical Compression. Berezovka's crushed leg bone and horizontally flattened penis show severe vertical compression before or soon after death. Dima was also compressed and flattened.

Eighteen pieces of the puzzle are now before us. Fitting this centuries-old jigsaw puzzle together will be our final task. As you will see, clever and imaginative proposals have been made, but most address only a few pieces of the puzzle.

Theories Attempting to Explain Frozen Mammoths

Ten theories have been proposed to explain the frozen mammoth puzzle. Each will be described below as an advocate would.

Fruitful theories answer not only the obvious, initial questions but also solve perplexing and seemingly unrelated problems. As we unravel the mystery of the frozen mammoths, we may answer broader questions and even uncover a sequence of dramatic, global events.

Robust theories also provide details that result in surprising and testable predictions. Keep this in mind as we examine all ten explanations. With each, ask yourself, "What predictions can this theory make?" If predictions are missing, the theory is probably weak.¹¹⁸ If theories could not be published unless they included many details and specific predictions, we would be mercifully spared many distractions and false ideas.

Hydroplate Theory. [For a more detailed description of the hydroplate theory, read pages 111–151.] On that terrible day, the rupture of the Earth's crust passed

What Happened?

Two strange, but admittedly secondary, reports may relate to the frozen mammoth problem. Each is so surprising that one might dismiss it as a mistake or hoax, just as with any single report of a frozen mammoth. However, because both reports are so similar yet originated from such different sources, it is probably best to reserve judgment. Each report was accepted as credible and published by a scientific authority. Each involved the sudden freezing of a river *in apparent defiance of the way bodies of water freeze*. Each contained frozen animals in transparent ice, yet natural ice is rarely transparent. Each discovery was in a cold, remote part of the world. One was in the heart of Siberia's frozen mammoth country.

The brief reports will be given exactly as they were written and translated. The first was published by the former Soviet Academy of Sciences. Alexander Solzhenitsyn, winner of the Nobel Prize for Literature in 1970, recalled this report (as best he could remember it) in the first paragraph of his preface to *The Gulag Archipelago*. Unfortunately, Solzhenitsyn did not give the report's date, so I began a difficult search. The report was finally found in Moscow's Lenin State Library.

Y. N. Popov, author of this report, was discussing the scientific importance of finding mammals frozen in Siberia. He then described some frozen fish:

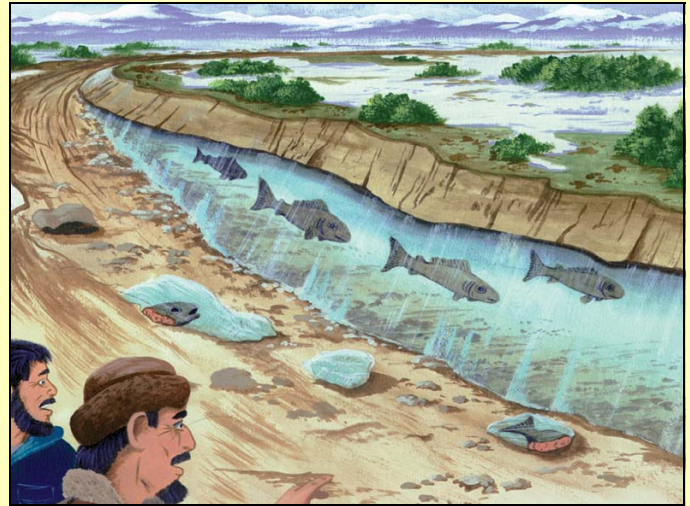

Figure 164: Fish Frozen in Underground Ice.

There are some cases of finds of not only dead mammals, but also fishes, unfortunately lost for science. In 1942, during road construction in the Liglikhtakha River valley (the Kolyma Basin) an explosion opened a subterranean lens of transparent ice encasing frozen specimens of some big fishes. Apparently the explosion opened an ancient river channel with representatives of the ancient ichthyological fauna [fish]. The superintendent of construction reported the fishes to be of amazing freshness, and the chunks of meat thrown out by the explosion were eaten by those present.¹²⁰

between what is now Siberia and Alaska in minutes. Jetting water from the fountains of the great deep first fell as rain. During the next few hours, some of the accelerating and expanding subterranean water that went above the atmosphere (where the effective temperature is several hundred degrees below zero Fahrenheit) froze and fell as hail.¹¹⁹ Some animals were suddenly buried, suffocated, frozen, and compressed by tons of cold, muddy ice crystals from the gigantic “hail storm.” Dirt in this ice prevented it from floating as the flood waters submerged these regions after days and weeks. Blankets of this muddy ice, hundreds of feet thick, insulated and preserved many animals during the flood phase. As the topmost layers of ice melted, the dirt in that ice remained and settled—blanketing and further insulating the deeper ice and buried animals.

Months later, after mountains were suddenly pushed up, the Earth's balance shifted, the Earth slowly “rolled” 34°–57°, so Siberia and Alaska moved from temperate latitudes (similar to north-central United States today) to their present positions. [For details, see Endnote 84 on page 148.] As the flood waters drained off the continents, whatever icy graves existed in warmer climates melted,

and buried animals decayed. However, many animals, buried in what are now permafrost regions, were preserved.

These conclusions can be reached quite simply. The evidence showing compression and suffocation of the frozen mammoths implies rapid burial. Rapid burial and sudden freezing suggest a supercold “ice dump.”

compression + suffocation = rapid burial
rapid burial + sudden freezing = an “ice dump”

Lake Drowning Theory.¹²¹ No catastrophe occurred. The well-preserved mammoths, with food in their stomachs and between their teeth, died suddenly, probably from asphyxiation resulting from drowning in a partially frozen lake, river, or bog. Such burials can preserve animal—and even human—tissue for thousands of years.

Crevasse Theory. Some mammoths fell into ice crevasses or deep snowdrifts. This protected them from predators, while ice preserved them for thousands of years.¹²²

Mud Burial Theory. In Siberian summers, the top foot or so of tundra thaws, so larger animals, even men, can easily become stuck—standing upright. Herds of mammoths,

The second report comes from M. Huc, a missionary traveler in Tibet in 1846. Sir Charles Lyell, often called the “father of geology,” also quoted this same story in the 11th edition of his *Principles of Geology*. After many of Huc’s party had frozen to death, survivors pitched their tents on the banks of the Mouroui-Oussou (which feeds into the famous Blue River). Huc reported:

*At the moment of crossing the Mouroui-Oussou, a singular spectacle presented itself. While yet in our encampment, we had observed at a distance some black shapeless objects ranged in file across the great river. No change either in form or distinctness was apparent as we advanced, nor was it till they were quite close that we recognized in them a troop of wild oxen. There were more than fifty of them encrusted in the ice. No doubt they had tried to swim across at the moment of congelation [freezing], and had been unable to disengage themselves. Their beautiful heads, surmounted by huge horns, were still above the surface; but their bodies were held fast in the ice, which was so transparent that the position of the imprudent beasts was easily distinguishable; they looked as if still swimming, but the eagles and ravens had pecked out their eyes.*¹²⁶

Any explanation for these strange discoveries must recognize that streams freeze from the top down.¹²⁷ The ice formed floats and then insulates the warmer liquid water below. The thicker the ice grows, the harder it is

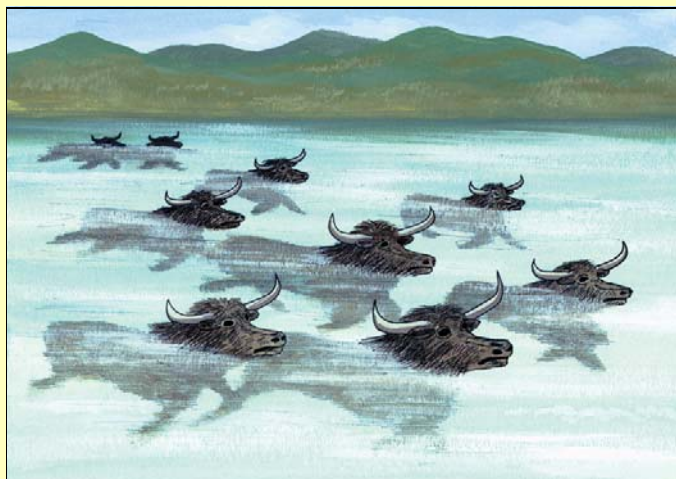

Figure 165: Frozen Oxen Found in Tibet in 1846.

for the liquid’s heat to pass up through the ice layer and into the cold air. Freezing a stream fast enough to trap more than fifty upright oxen *in the act of swimming across* seems impossible, especially because a stream’s velocity varies across its width. Therefore, different parts of the stream should freeze over many days or hours. Freezing a river so fast that large fish are frozen, edible, and underground, defies belief. However, the similarities with the frozen mammoths are so great that these reports may be related. An explanation will follow shortly.

rhinoceroses, and buffalo made summer migrations to northern Siberia and Alaska. Some became stuck in this mud; others were overwhelmed and suffocated in mudslides. Still others died for various reasons and were then buried in slow mudflows during several summer thaws. Sudden cold spells—sometimes followed by long, cold winters—froze and preserved many mammoths.¹²³

River Transport Theory. Mammoths and other animals lived farther south in the temperate zone of Asia where food was abundant. Flooding rivers floated their remains from Central Siberia on the north flowing rivers.¹²⁴

Extinction-by-Man Theory. Man exterminated mammoths, just as man almost exterminated the buffalo. Man, in hunting mammoths, pursued and pushed them north into Siberia and Alaska. There, they died from harsh weather, lack of food, or the direct killing by man.¹²⁵

Bering Barrier Theory. As ice accumulated on continents during the last Ice Age, sea level was lowered by 300 feet and the Bering Strait was closed. This newly created land bridge allowed people and animals, including mammoths, to migrate between Siberia and Alaska and onto Arctic islands. Because the warmer Pacific waters could no longer mix through the Bering Strait with the cold Arctic

Ocean, the Pacific waters became even warmer and the Arctic waters even colder. The resulting heavy evaporation from the Pacific caused extreme snow falls on higher, colder land masses north of the Bering barrier. Mammoths and others were buried in severe snow storms early one fall. As the Ice Age ended, heavy rains washed soil down on top of compacted snow deposits, forming rock ice. Some frozen mammoths and rock ice are still preserved. Since then, glacial melting raised sea levels and reestablished the Bering Strait.¹²⁸

Mild Ice Age Theory.¹²⁹ During snow and dust storms about 700 years after the global flood, some mammoths were frozen, buried, suffocated, and preserved—a few standing up. Here is how it happened.

The flood waters were warm, if not hot, because they came from 3,000–10,000 feet below the Earth’s crust where temperatures are 30–100°F hotter. Warm, post-flood oceans produced both heavy evaporation and snow fall. As snow depths increased, the Ice Age began;¹³⁰ it lasted about 700 years—until the oceans cooled sufficiently. Thick ice sheets built up in continental interiors and lowered sea levels somewhat. During those 700 years, mammoths migrated from the mountains of Ararat to northern Siberia and from there to Alaska during a brief

Why Did It Get So Cold So Quickly?

Let's put aside all possible explanations for the frozen mammoths and just ask what must happen for the mammoth's temperatures to drop to at least -150°F (so rapidly that the food deep inside their warm bodies was frozen and, therefore, preserved).

Temperatures can drop for several reasons: chemical reactions, reduction of heat from the Sun, transfer of heat, *expansion of a gas, or evaporation of a liquid*. First, let's eliminate a few possibilities. Chemical reactions within the atmosphere have trivial thermal consequences. Could the Sun have suddenly put out less heat, thereby lowering the temperature of Siberia and Alaska? That happens every night, but temperatures drop too slowly.

If heat was transferred away from Siberia and Alaska, **where** and **how** was it transferred? Heat, which always travels from hot bodies to cold bodies, is transferred by three means: conduction, radiation, and convection. *Conduction* mainly applies to solids, as when heat travels (conducts) along a metal rod whose tip is held in a fire. Conduction would not play a big role for a large volume of gas, such as the atmosphere. *Radiation* transfers too little heat too slowly at atmospheric temperatures.

Convection occurs when a moving fluid (liquid or gas) transfers heat from a hot to a cold region. For example, heat is transferred by convection up a chimney. The heat is transported from the hot air just above the fire to the cold air outside the chimney. If, at one time, Siberia and Alaska cooled to -150°F by convection, an even colder region had to absorb the heat; engineers call this a *heat sink*. Finding a supercold sink would be even more difficult than explaining a temperature drop to only -150°F . No sufficiently cold sink exists in or below the atmosphere, but such a sink lies above the atmosphere—in the vacuum of space—where temperatures are about 300°F colder than -150°F ! This may answer the “**where**” question.

We could not eliminate the two possibilities highlighted above: *expansion of a gas, and evaporation of a liquid*. Both would drop temperatures drastically if enough water was very rapidly accelerated out of the atmosphere. That is precisely what the fountains of the great deep did. By the end of Part II of this book, you will see that nuclear energy provided astonishing accelerations and expansions of supercritical water into outer space, dropping the temperatures in most of the fountains to almost absolute zero (-460°F)! This then answers the difficult “**how**” and “**where**” questions. [See “**Rocket Science**” on pages 581—582.]

exposure of a land bridge across the Bering Strait. With warm winds off the warm Arctic Ocean producing a tolerable climate for the ice age mammoths, their numbers grew to about 10 million. Other temperate animals were also able to live at those high latitudes. As the oceans cooled, fierce storms developed. Blowing dust, called *loess*, suffocated and buried most mammoths, some standing up. Other storms converted the dust to permafrost.

Shifting Crust Theory. Before the last Ice Age, the Hudson Bay was at the North Pole. Siberia and Alaska were farther south and supported abundant vegetation and large herds of mammoths. As vast amounts of ice accumulated at what was then the North Pole, the crust on the spinning Earth became unbalanced and slid, moving Siberia northward. Because the Earth is slightly flattened at the poles and bulges at the equator, the shifting crust produced many ruptures. Volcanic gas was thrown above the atmosphere where it cooled and descended as a supercold “blob.” Airborne volcanic dust lowered temperatures on Earth and caused phenomenal snow storms. Mammoths and other animals living in Siberia and Alaska were suddenly frozen and buried in extremely cold snow. Some are still preserved.¹³¹

Meteorite Theory. At the end of the last Ice Age, a large iron meteorite hit Earth's atmosphere. The resulting heat temporarily melted the top layers of the frozen tundra, causing mammoths to sink into muck. Poor visibility caused others “to blunder to their deaths in icy bogs.”¹³²

Evaluation of Evidence vs. Theories

Table 12 summarizes how well each theory explains the many strange things associated with frozen mammoths. Each column corresponds to a theory, and each row represents an unusual detail that requires an explanation. As with a traffic light, a green circle means “go.” That is, in my opinion, the column's theory reasonably explains that row's diagnostic detail. Yellow (caution) and red (stop) circles indicate moderate and serious problems, respectively. Numbers in Table 12 refer to additional information below. Table 12 shows both the details and the broad perspective—“the trees *and* the forest.”

Readers may make their own judgments and independently assess each theory's plausibility. For example, if you feel that a detail or theory has been omitted or misstated, modify the table. This approach focuses future discussions on areas of critical disagreement. It also helps keep all details and competing theories in mind, encouraging balance and thoroughness. Often, a disagreement becomes moot when one realizes that other facts oppose some theory. When a theory is proposed, usually only the details supporting it and opposing competing theories are

Table 12. Evidence vs. Theories: Frozen Mammoths

		Theories									
		Hydroplate	Lake Drowning	Crevasse	Mud Burial	River Transport	Extinction by Man	Bering Barrier	Mild Ice Age	Shifting Crust	Meteorite
Evidence to Be Explained	Abundant Food	● 1	⊗ 12	⊗ 20	●	●	⊗ 56	⊗ 70	⊗ 79	●	⊗ 99
	Warm Climate	●	⊗ 13	⊗ 21	●	●	●	● 70	⊗ 79	●	● 99
	Away from Rivers	●	●	●	⊗ 33	⊗ 45	●	●	●	●	●
	Yedomas and Loess	● 2	● 14	● 22	● 34	● 45	● 57	● 71	⊗ 80	● 93	● 100
	Elevated Burial	● 3	●	● 23	● 33	● 46	● 58	●	●	●	●
	Multi-Continental	●	● 14	● 22	● 34	● 45	●	● 72	● 79	●	●
	Rock Ice	● 4	⊗ 15	⊗ 24	⊗ 35	⊗ 47	⊗ 59	● 73	● 81	● 94	⊗ 101
	Frozen Muck	● 3	● 14	● 25	● 34	● 45	⊗ 60	⊗ 74	● 82	⊗ 95	● 100
	Sudden Freezing	●	● 16	● 26	⊗ 36	●	●	●	⊗ 83	●	●
	Suffocation	● 5	●	● 22	●	●	● 61	● 75	● 84	●	● 100
	Dirty Lungs	● 6	● 17	⊗ 27	● 37	● 48	⊗ 62	● 76	●	●	●
	Peppered Tusks	● 6	⊗ 17	⊗ 27	⊗ 37	⊗ 48	⊗ 62	⊗ 76	⊗ 80	⊗ 93	●
	-150°F	● 7	⊗ 16	⊗ 28	⊗ 34	⊗ 45	⊗ 57	⊗ 72	⊗ 85	⊗ 93	⊗ 102
	Large Animals	● 7	●	⊗ 29	●	⊗ 45	⊗ 57	● 77	● 86	⊗ 93	●
	Summer-Fall Deaths	● 8	●	●	●	● 49	●	●	● 87	● 96	●
	Animal Mixes	● 3	⊗ 18	⊗ 30	⊗ 38	●	⊗ 63	●	●	●	⊗ 103
	Upright	● 9	● 14	● 31	● 39	● 50	⊗ 64	●	●	●	●
Vertical Compression	● 9	⊗ 19	● 22	● 40	● 45	● 57	● 72	● 88	● 93	● 100	
Other	● 10–11		● 32	● 41–44	● 51–55	● 65–69	● 78	⊗ 89–92	● 97–98	● 104	

Key: ● Explained by theory.
 ● Theory has moderate problems with this item.
 ⊗ Theory has serious problems with this item.
 N/A Not Applicable

The numbers in this table refer to amplifying explanations on pages 281–291.

mentioned. Table 12 contrasts all published theories with all known diagnostic details.

In seeking the cause of many strange and related details, one is tempted to use a separate explanation for each detail. Throughout the history of science, experience has shown that the simplest theory explaining the most details is probably correct. For example, a sudden rash of fires in a city may all be unrelated. However, most investigators would instinctively look for a common explanation. Centuries ago, each newly discovered detail of planetary motion required, in effect, a new theory. Later, one theory (Newton's Law of Gravitation) provided a simple explanation for all these motions.

Details Relating to the Hydroplate Theory

1. ● **Abundant Food.** Winter sunlight inside the Arctic Circle is so scarce that vegetation hardly grows, regardless

of temperature. How could mammoths survive during even a warm winter? Clearly, mammoths were living at temperate latitudes before the flood.

As explained on pages 111–151, near the end of the flood, major mountains suddenly formed, so the Earth became slightly unbalanced and began a slow 34°–57° roll. Although the Earth's spin axis did not change its orientation in space, the land at the preflood North Pole shifted to central Asia while some mammoths' temperate habitats shifted northward to near the Arctic Circle. This roll also explains why dinosaur remains are found inside Antarctica and the Arctic Circle. [See Endnotes 84–85 on page 148 for details and evidence.]

(The shifting crust theory recognizes this problem of feeding millions of mammoths during winter months. That theory says the Earth's crust must have shifted, moving Siberia and Alaska northward. However, no force could slide the entire Earth's crust—rock on rock.)

2. ● *Yedomas and Loess.* (These terms are explained on page 275. Pages 260-266 explain why the subterranean water was saturated with carbon dioxide.) The extreme pressure in the subterranean chamber accelerated the escaping carbon-rich water to hypersonic speeds, rapidly eroding rocks. Eroded dirt particles of various sizes were swept up by the water and expelled into and above the atmosphere. As you will see, the higher a muddy droplet rose, the more likely it was to lose the larger particles carried inside. Therefore, droplets that rose above the atmosphere and froze contained the powdery dirt particles that comprise yedoma hills and the world's loess.

Visualize a water droplet jetting up through the atmosphere. Atmospheric pressure drops as it goes higher, so some water evaporates from its surface. Evaporation cools the droplet, just as evaporating perspiration cools a person. Gusts of air and water vapor strike the droplet from differing directions, each time dragging its surface around toward the opposite, or downwind side. This creates a strong and complicated circulation within the droplet and chaotic waves on its surface. Sometimes the droplet fragments into two or more pieces, but the smaller each piece becomes, the stronger the molecular forces (the surface tension) holding it together.

In the droplet are many tiny dirt particles. Within the droplet, the flow carries the smaller particles more smoothly than larger particles,¹³³ while the larger particles are sometimes shaken out of the buffeted droplet. When the droplet finally freezes high above the atmosphere, only the smallest dirt particles remain. Being encased in ice, they are protected from water erosion that would round and smooth their sharper corners.

Much of this dirt and dirty ice fell to Earth in a giant hail and windstorm as the flood began. Trees and vegetation were ripped up, pulverized, and mixed with the fallen, muddy hail. Animals froze and suffocated. The thick, muddy ice insulated much of the deeper ice when the waters temporarily flooded the land. Ice that melted, during or after the flood, left behind tiny, angular dirt particles (now called *loess*) and dissolved salts.

After the flood, some ice layers that had not yet melted began melting in many isolated locations. Water, collected in these depressions during the summer, accelerated nearby melting. Today's hilly yedomas remain. Therefore, in Arctic regions where little summer melting occurs, loess, salt, vegetation, and mammoth remains are preserved in cold yedomas.

Loess is often found near formerly glaciated areas, especially downwind of ice age drainage channels, such as the Mississippi and Missouri Rivers. In warmer climates, wind removed the loess, rain leached salts from the soil, and the organic material decayed.



PREDICTION 21: High concentrations of *loess* particles will be found in the bottom several hundred feet of most ice cores drilled in Antarctica and Greenland.

The bottom layers of ice sheets in Greenland, Canada, and Antarctica contain up to 50 times more microparticles than the glacial ice above.¹³⁴ Ice crystals containing these microparticles are much smaller than normal glacial ice crystals. This suggests that the hail that buried and froze the mammoths was smaller than normal hail. Another study found that the lower portion of the Greenland ice sheet contains abnormally high amounts of dust, sea salt, and other chemicals.¹³⁵

3. ● *Elevated Burials, ● Frozen Muck, ● Animal Mixes.* Bones, ivory, and flesh are found on higher ground, such as in yedomas and on Arctic islands. (The preceding paragraphs explain why mammoth remains are found in yedomas.) Prey and predator may also have sought protection from the greater common enemy—rising waters from rain that preceded the muddy hail, and noxious gases evaporating from the hail. Larger animals, such as mammoths and rhinoceroses, in rushing to higher ground, crushed and buried smaller animals in mud and ice. This may explain the antelope skull under Berezovka, and why such dense concentrations of bones and ivory are found on barren islands well inside the Arctic Circle.

Fine sediments in the muddy rain and ice mixed with pulverized vegetation to form *muck*. This cold, soupy mixture, along with ripped up forests, flowed into valleys and other low areas, smoothing the topography into flat, low plateaus. Later this muck froze, preserving to this day its distinguishing organic component and loess.



PREDICTION 22: Muck on Siberian plateaus should have a wide range of thicknesses. The greatest thickness will be in former valleys. Preflood hilltops will have the thinnest layers of muck. Drilling or seismic reflection techniques should confirm this.

4. ● *Rock Ice.* Table 12 on page 281 shows why rock ice is a Type 3 ice. As stated on page 127, the subterranean waters contained large quantities of dissolved salt and carbon dioxide. Carbon dioxide contributed to the carbonates found in loess.



PREDICTION 23: Rock ice will be found to be salty.¹³⁶

Before the flood, the subterranean water, sealed off from the atmosphere, contained no dissolved air. As the fountains of the great deep exploded up through the atmosphere, rapid and steady evaporation from the rising liquid forced gases away from, instead of toward, each

rising liquid particle. Therefore, the water that froze above the atmosphere had little dissolved air but much carbon dioxide. Both froze to become a mixture of water-ice and frozen carbon dioxide, or “dry ice.”

Ice absorbs air very slowly, especially the inner portion of a large volume of falling ice particles, so little air was absorbed as muddy hail fell to Earth. Once the ice was on the warm ground, some “dry ice” and water-ice slowly evaporated as white clouds. As ice depths increased to perhaps several hundred feet, these clouds billowed up through gaps between the ice particles, forcing out any air that might have been between them. Eventually, the weight of the topmost layers of ice essentially sealed the lower ice from the air above. This is why Herz saw the ice under Berezovka turn yellow-brown as the ice first contacted and reacted chemically with air.



PREDICTION 24: Bubbles in rock ice will be found to contain less air and much more carbon dioxide than normally found in ice bubbles formed today.

The Ice Age followed the flood. Since then, the surface of the ground in Siberia and Alaska has melted slightly each summer. In some parts of Siberia and Alaska, this included several feet of rock ice. When a layer of this dirty ice melted, the water drained away, leaving particles of dirt and vegetation behind. This remaining clay and silt provided an insulating blanket, causing less ice to melt each succeeding year. Most of the unsorted clay and silt above rock ice came from melted rock ice.



PREDICTION 25: Dirt and organic particles in rock ice will closely resemble those in the overlying muck.

5. ● Suffocation. Suffocation could have occurred three ways: (a) being buried alive in muddy hail, (b) breathing too much carbon dioxide from evaporating “dry ice,” or (c) lung tissue freezing so oxygen could not diffuse into the blood and/or carbon dioxide could not diffuse out of the blood.

6. ● Dirty Lungs, ● Peppered Tusks. The jetting fountains of the great deep produced extreme winds. Dirt filled the atmosphere for a few hours before rain, ice, and falling dirt landed. This explains why Dima’s entire digestive and respiratory tract contained silt, clay, and small particles of gravel, and why high-velocity dirt particles peppered animals and even left “shrapnel,” on one side of hard mammoth tusks. [See Figure 158 on page 270.]

7. ● -150°F, ● Large Animals. Almost all the energy of a falling hail particle ends up accelerating air downward, not heating the particle.¹³⁷ The result was violent down-drafts of cold air.

Larger, stronger animals, such as mammoths and rhinoceroses, best withstood the driving rain and cold wind as they sought safety. Smaller animals would be tossed about more by the high winds and would suffocate sooner because their bodies process the noxious gases faster. Death, burial, and, therefore, decay in the warmer deposits would come earlier for the smaller animals.

Mammoths and rhinoceroses were still standing as the colder hail began piling up—hail with temperatures of about -150°F. This supercold ice pressing against their bodies rapidly froze even their internal organs.

Extremely cold, muddy hail fell to the bottoms of streams, rivers, and lakes, quickly freezing the water from within; cool air did not freeze the water from above. The hail did not float, because it contained dirt. [See “What Happened?” on pages 278 and 279.]

8. ● Summer-Fall Deaths. According to this theory, all frozen mammoths died almost simultaneously. However, the different methods investigators have for estimating the season of death give slightly different times. Some differences may be because pre-flood climates differed from those of today. A larger sampling with more consistent method is needed. One possibility would be to examine the outermost growth ring on hundreds of ivory tusks. This examination should include the isotope abundances across each ring.

9. ● Upright, ● Vertical Compression. The massive, violent hail storm buried mammoths and rhinoceroses alive, many standing up and compressed from all sides. Babies, such as Dima, were flattened. Exposed parts of adult bodies, unsupported by bone, were vertically flattened. Sometimes even strong bones were crushed by axial compression. Encasement in muddy ice maintained the alignment of Berezovka’s leg bone as it was crushed lengthwise, before or soon after death.

Ice slowly flows downhill as, for example, in glaciers. Such a downward flow, pushing Berezovka tail first as he tried to climb to higher ground, would explain his forward swept hind legs, humped back, displaced vertebrae, and spread front legs bent at the “ankles.”

10. ● Other/Fossils. The hydroplate theory states that the frozen animals were buried in muddy hail as the flood began. During the following months, sedimentary layers were deposited. Those sediments and their fossils were then sorted by liquefaction. [See pages 195–213.]



PREDICTION 26: One should not find marine fossils, layered strata, oil, coal seams, or limestone directly beneath undisturbed rock ice or frozen mammoth carcasses.¹³⁸

This is a severe test for the hydroplate theory, because a few crude geologic maps of Siberia imply that marine fossils lie within several miles of the frozen remains. How accurate are these geologic maps in this unexplored region, and what deposits lie *directly beneath* frozen carcasses? (If dead mammoths floated on the flood waters, their flesh would not be preserved, but their bones might be found above marine fossils, coal, etc.)

Sedimentary layers generally extend over large areas and sometimes contain distinctive fossils. One can construct a plausible geologic map of an area (a) if many deep layers are exposed as, for example, in the face of a cliff, (b) if similar vertical sequences of fossils and rock types are found in nearby exposures, and (c) if no intervening crustal movement has occurred. If all three conditions are satisfied, then the layers with similar distinctive fossils are probably connected. To my knowledge, such layers have not been found beneath any frozen mammoth.

Nor is there any known report of marine fossils, limestone deposits, or coal seams directly beneath any frozen mammoth or rhinoceros remains. Tolmachoff, in his chapter on the geology of the Berezovka site, wrote that “Marine shells or marine mammals have never been discovered in [deposits having frozen mammoths].”¹³⁹ Hern von Maydell, reporting on his third frozen mammoth, wrote, “despite my thorough search, not a single shell or fossil was found.”¹⁴⁰ Beneath the Fairbanks Creek mammoth, sediments down to bedrock contained no marine fossils, layered strata, coal seams, or limestone.¹⁴¹

11. ● Other/Radiocarbon. According to the hydroplate theory, all frozen mammoths and rhinoceroses died simultaneously. However, their radiocarbon ages vary. [See Table 10 on page 269.] For an explanation of radiocarbon dating and its assumptions, see pages 506–509. Those pages explain why 40,000 radiocarbon years (RCY) is a typical radiocarbon age for most frozen remains, and why 40,000 radiocarbon years correspond to about 5,000 actual years. A slight amount of contamination of the remains, for example, by groundwater, would lower their radiocarbon age considerably, especially something living as the flood began. This probably explains why different parts of the first Vollosovitch mammoth had widely varying radiocarbon ages—29,500 and 44,000 RCY.¹⁴² One part of Dima was 44,000 RCY, another was 26,000 RCY, and “wood found immediately around the carcass” was 9,000–10,000 RCY.¹⁴³ Food in the Shandrin mammoth gave radiocarbon ages that differed by 10,000 years.¹⁴⁴ The lower leg of the Fairbanks Creek mammoth had a radiocarbon age of 15,380 RCY, while its skin and flesh were 21,300 RCY.¹⁴⁵ The two Colorado Creek mammoths had radiocarbon ages of $22,850 \pm 670$ and $16,150 \pm 230$ years.¹⁴⁶ Because a bone fragment at one burial site fits precisely with a bone at the other site 30 feet

away,¹⁴⁷ and the soil had undergone considerable compression and movement, both mammoths probably died simultaneously.



PREDICTION 27: Blind radiocarbon dating of different parts of the same mammoth will continue to give radiocarbon ages that differ by more than statistical variations should allow. [Endnote 154 on page 432 describes blind testing.] Contamination by groundwater will be most easily seen if the samples came from widely separated parts of the mammoth's body with different water-absorbing characteristics.

Note: From here to page 291, the reader may wish to examine only discussions concerning theories of personal interest.

Details Relating to the Lake Drowning Theory

12. ⊗ Abundant Food. Lack of winter sunlight inside the Arctic Circle would choke off the mammoth's food supply each winter, even if temperatures were warm or the mammoth was “adapted” to the cold.

13. ⊗ Warm Climate. Vegetation in the digestive tracts of frozen mammoths shows that they died in a mild climate during the late summer or early fall when frozen lakes or rivers would not exist. Many weeks of freezing temperatures are needed to form ice thick enough for a large, hooved animal to venture far enough from shore to drown.

14. ● Yedomas and Loess, ● Multi-Continental, ● Frozen Muck, ● Upright. The lake drowning theory does not explain why mammoths, yedomas, and loess are related, why these peculiar events occurred over such wide areas on three continents, where so much muck originated, why muck has sometimes buried forests, why yedomas contain so much carbon, or why so many mammoth bodies and skeletons were found upright.

15. ⊗ Rock Ice. The ice near several carcasses was not lake or river ice. It was Type 3 ice, not Type 1 ice.

16. ● Sudden Freezing, ⊗ -150°F. Although burial in peat bogs can retard bacterial decay and preserve bodies for thousands of years, only a rapid and extreme temperature drop can stop the destructive activity of enzymes and stomach acids.

17. ● Dirty Lungs, ⊗ Peppered Tusks. Drowning in a lake would not fire millimeter-size particles, rich in iron and nickel, into one side of mammoth tusks or force gravel into Dima's lungs. Nor would silt, clay, and gravel work their way into Dima's intestines after a sudden drowning.

Table 13. Mammoth Myths vs. Mammoth Facts

Mammoth Myths	Facts
1. Fresh buttercups were in the mouth and stomach of the Berezovka mammoth.	Its stomach contained three <i>seeds</i> from plants that produce delicate, yellow buttercups. Fragments of other flowers were in its stomach. No large flowers were in its mouth.
2. People have been served mammoth steaks. ¹⁴⁸	These reports persist but are never specific enough to verify. For example, Lydekker reported that “sleigh dogs, as well as Yakuts themselves, have often made a hearty meal on mammoth flesh thousands of years old.” ¹⁴⁹ Lydekker never visited Russia, let alone Siberia. The following report by Herz appears valid. Herz wrote in his diary that the Berezovka mammoth “looks as fresh as well-frozen beef or horse meat. It looked so appetizing that we wondered for some time whether we should not taste it, but no one would venture to take it into his mouth, and horse flesh was given in the preference. The dogs cleaned up whatever mammoth meat was thrown them.” ¹⁵⁰ In 1982, construction workers in Siberia uncovered a frozen mammoth and fed it to dogs. ¹⁵¹
3. Mammoths are encased in ice. Their preservation is complete.	Charles Lyell popularized this myth by writing that mammoth remains are found in icebergs and frozen gravel. ¹⁵² There are very few reports of complete encasement in ice. ¹⁵³ Other mammoths were near or partially in ice. Herz and Pfizenmayer only <i>believed</i> that their Berezovka mammoth was once fully encased in ice. Most frozen mammoths are found partially preserved in frozen muck or sediments.
4. The mammoth’s small ears, short tail and legs, and anal flap reduced its heat loss in cold Arctic air. This shows that the mammoth was an Arctic animal.	Animals with large ears and long tails, such as hares and foxes, survive quite well in the Arctic. The legs and tails of Arctic foxes are similar to those of foxes living in warmer climates. While a slight correlation exists between smaller ears in colder habitats, other factors play a stronger role, such as metabolic efficiency, food availability, and adjustable insulation. The African elephant also has a prominent anal flap. ¹⁵⁴
5. Mammoths used their long curved tusks to remove snow from plants they ate on the ground. Most tusks show these wear marks.	Wild elephants live far from snow, yet they also have wear marks on their shorter, less vulnerable tusks. Mammoth tusks do not show extreme abrasion from being scraped over rocky soil in search of food under snow. (Besides, “shoveling” snow with a long, curved stick is a good way to break the stick.) A wild elephant spends about 16 hours a day eating and searching for food. ¹⁵⁵ If food were buried under snow, mammoths would not have enough hours in the day to gather sufficient food to survive.
6. The curve in the mammoth tusks almost forms a circle.	“Not one tusk in ten forms a third of a circle, not one in twenty even a semicircle.” ¹⁵⁶ Artists and museums have popularized this misconception.
7. The wool on woolly mammoths protected them from the Siberian cold.	The term “woolly” is misleading because true wool has tiny, overlapping scales that interlock and trap air, making it an excellent insulator. Unlike sheep’s wool, mammoth “wool” is only short, coarse underhair. Mammoth hair, some of it long and bristly, has relatively few fibers per square inch.
8. A mammoth’s thick skin and hairy body protected it from the Arctic cold.	See the earlier section titled “Mammoth Characteristics and Environment” on page 270 .
9. Mammoths were larger than today’s elephants.	Mammoths were larger than Asian elephants, but smaller than African elephants. Usually, mammoths’ tusks and heads were larger than those of all elephants. ¹⁵⁷
10. Larger animals generate more heat per unit of body surface area. Therefore, the mammoth would stay warm, even in the Arctic winter.	The first sentence is true. However, an Arctic mammal must avoid having its warm skin melt snow, as explained earlier. The mammoth’s skin would tend to melt snow, especially if the animal lay down. Its high ground pressure would compress and reduce the insulation provided by its hair. (Elephants doze standing up, but when they feel safe, they will lie down for a few hours of sleep.) Sick or injured mammoths, unable to stand, would probably not have survived. Young mammoths were even more vulnerable. They generated less heat per unit of body surface area and probably spent more time lying down. Newborn mammoths, wet and initially unable to walk, could not have survived for long lying on permafrost, especially if they were born during the long winter. (Elephants are born at all times of the year.)

18. ❌ *Animal Mixes.* If mammoths occasionally fell through ice on an arctic lake, why are the bones of so many temperate animals found together? Why do prey lie near their predators? Large, hoofed animals seldom venture out on frozen lakes.

19. ❌ *Vertical Compression.* Falling into a lake would not produce the vertical compression found in Dima and Berezovka.

Details Relating to the Crevasse Theory

20. ❌ *Abundant Food.* Same as item 12.

21. ❌ *Warm Climate.* The contents of Berezovka’s stomach showed that he lived in a warm climate, not one containing ice crevasses. Furthermore, tree fragments and roots were found beneath him. Trees do not grow near icy crevasses. Glacial climates prevent tree growth. Many animals and plants buried in northern Siberia and Alaska

live only in temperate climates today. Besides, mammoths were not Arctic animals.

22. ● Yedomas and Loess, ● Suffocation, ● Vertical Compression, ● Multi-Continental. The crevasse theory does not explain why mammoths, yedomas, and loess are related, why yedomas contain so much carbon, why these peculiar events occurred over such wide areas on three continents, why some of these huge animals suffocated, or what compressed Dima and Berezovka vertically.

23. ● Elevated Burial. Falling into a crevasse or being transported downhill in a glacier would not herd mammoths up onto islands or up near the higher elevations of flat, low plateaus. Crevasses form only on steep slopes.

24. ● Rock Ice. Mammoths are sometimes buried near Type 3 ice. Crevasses have only Type 2 ice.

25. ● Frozen Muck. Frozen mammoths are found primarily in frozen muck, not ice. Where did all the muck come from, and why are so many large trees buried in it?

26. ● Sudden Freezing. Let us assume that after Berezovka had eaten beans at the base of a glacier, he climbed up to a crevasse, fell in, and died. His stomach acids and enzymes would have destroyed his food in a few hours. Because crevasses are not at the base of glaciers, Berezovka's long trip up the glacier and subsequent freezing must have been unbelievably rapid to prevent this destruction. Besides, what could motivate a grazing beast to climb a long, steep, icy slope?

27. ● Dirty Lungs, ● Peppered Tusks. Falling into a crevasse would not fire millimeter-size particles (rich in iron and nickel) into mammoth tusks, put gravel in Dima's lungs or silt, clay, and gravel in Dima's intestines.

28. ● -150°F. Snow is a surprisingly good insulator, as those who live in igloos know. Also, transferring heat from a solid object, such as a mammoth's body, to stagnant air is a slow process. Both conditions would exist if a mammoth fell into a crevasse. Steep crevasse walls would shield the body from cold winds, and glacial ice and stagnant air would insulate the mammoth from sharp drops in the outside temperature. Eventually, the carcass would freeze, but the residual heat in its huge body would delay freezing and cause putrefaction. Hoyle explains:

*I have been informed that, today, when reindeer fall down crevasses in the Greenland ice, they are subsequently found to be in an unpleasantly putrefied condition. It seems that, no matter how cold the air is, the body heat of the dead animal is sufficient to promote bacterial decomposition.*¹⁵⁸

Warmer internal organs, such as the stomach, experience even more decay. Furthermore, this theory cannot begin to explain a sudden temperature drop to -150°F.

29. ● Large Animals. The crevasse theory does not explain why primarily larger animals fell into icy crevasses and froze. Actually, the larger the animal, the greater its internal heat and the more the animal should decay.

30. ● Animal Mixes. If an occasional mammoth fell into an ice crevasse, why are bones of so many kinds of animals found together? While some might argue that an adult mammoth climbed up a glacier, why would a rhinoceros or a baby, such as Dima, do so? A heavy, low-slung rhinoceros could not walk in deep snow. Beavers, squirrels, and birds do not fall into crevasses, but all have been found near frozen mammoths.

31. ● Upright. Herz, who excavated and analyzed the Berezovka mammoth, felt it had fallen into a crevasse, because it had several broken bones, was frozen, and was found in an upright, although contorted, position. Normally, with a broken pelvis, a broken shoulder, a few broken ribs, and a crushed leg bone, he should have been lying on his side. However, a fall would rarely break bones in different parts of the body. To break so many bones requires many large forces acting from different directions. A blow received from a fall might explain a few fractures, but probably not all, especially the aligned, but crushed fractures of a leg.

32. ● Other/Glaciers. Only a few mountains in northeastern Siberia show evidence of former glaciers.

Details Relating to the Mud Burial Theory

33. ● Away From Rivers, ● Elevated Burials. A very large mudslide, such as might occur near a river bank, is required to suffocate and bury large animals. Yet, frozen remains of mammoths and rhinoceroses are sometimes found in the interior of hilly islands, or on high ground far from rivers and river mud. Besides, northern Siberian rivers transport relatively little mud.¹⁵⁹ Mud moves slowly, if at all, on cold, flat, low plateaus. Rhinoceroses do not live far above the level of rivers or oceans.

34. ● Yedomas and Loess, ● Multi-Continental, ● Frozen Muck, ● -150°F. The mud burial theory does not explain why mammoths, yedomas, and loess are related, why yedomas contain so much carbon, why these peculiar events occurred over such wide areas on three continents, where so much muck originated, why it contains buried forests, or why temperatures dropped rapidly to -150°F.

35. ● Rock Ice. Burial in mud that later froze would produce Type 1 ice, not Type 3 ice.

36. ❗ **Sudden Freezing.** The coldest a mud flow could be is 32°F. The air would be even warmer. If Berezovka had been encased in mud, a good insulator, his stomach contents would have taken at least 20 times longer to cool enough to stop acids and enzymes from destroying the vegetable matter in his stomach. Simply stated, burial in even cold, flowing mud could not freeze a mammoth rapidly enough. Even if the atmospheric temperature dropped to -200°F after the mammoth was buried, freezing would not be rapid enough to overcome the mud's insulating effect.

37. 🟡 **Dirty Lungs,** ❗ **Peppered Tusks.** One researcher used the mud burial theory to explain why Dima had silt, clay, and small particles of gravel in his respiratory and digestive tract.¹⁶⁰ While these particles might enter the upper digestive tract, they would not enter the lungs and lower digestive tract. Such particles would need to be in the air for some time, as would occur during sustained high winds—such as the greatest storm the Earth has ever experienced. Nor would burial in mud fire millimeter-size particles, rich in iron and nickel, into mammoth tusks.

38. ❗ **Animal Mixes.** Many animals, such as beavers, marmots, voles, and squirrels, whose bones lie near frozen mammoths, do not create enough ground pressure to sink into mud.

39. 🟡 **Upright.** The upright Berezovka mammoth suffocated. Burial in a mudslide might explain his suffocation, but it would not explain his upright posture. Becoming stuck in shallow mud might explain the upright posture, but it would not explain the suffocation. The Benkendorf mammoth and others were also upright. [See Table 10 on page 269.]

40. 🟡 **Vertical Compression.** Burial in a typical mud flow would not flatten Dima or produce the severe vertical compression found in Berezovka.

41. 🟡 **Other/Feet.** Elephants rarely become stuck in mud, because their feet expand as weight is placed on them and narrow as they are lifted. In northern Siberia only a thin layer of soil thaws in the summer.

42. 🟡 **Other/Mouth.** A large animal trapped in mud would probably live for hours, if not days. Therefore, food should not be preserved in its mouth and digestive tract, as occurred for a rhinoceros and several mammoths.

43. 🟡 **Other/Scavengers.** Large animals buried in mud flows should frequently show marks of scavengers on the top parts of their bodies where mud had not yet reached. No known report has described such a pattern.

44. 🟡 **Other/Rhinoceroses.** Rhinoceroses and babies (such as Dima) do not migrate as this theory proposes.

Details Relating to the River Transport Theory

45. ❗ **Away From Rivers,** 🟡 **Yedomas and Loess,** 🟡 **Multi-Continental,** 🟡 **Frozen Muck,** ❗ **-150°F,** ❗ **Large Animals,** 🟡 **Vertical Compression.** The river transport theory does not explain why frozen mammoths are often found far from rivers, why mammoths, yedomas, and loess are related, why these peculiar events occurred over such wide areas on three continents, why yedomas contain so much carbon, where so much muck originated, why muck has sometimes buried forests, why temperatures suddenly dropped to -150°F, why primarily the larger animals were frozen and preserved, or what compressed Dima and crushed Berezovka before or soon after death.

46. 🟡 **Elevated Burials.** Rivers would not deposit large carcasses on the higher levels of plateaus. A few mammoths are found 1,000 feet above nearby rivers.¹⁶¹

47. ❗ **Rock Ice.** With the river transport theory, one would expect to find Type 1 ice, not Type 3 ice.

48. 🟡 **Dirty Lungs,** ❗ **Peppered Tusks.** If Dima drowned, silt and clay might have entered his lungs, but not gravel. Nor would drowning distribute those particles within his intestines or embed “shrapnel” in mammoth tusks.

49. 🟡 **Summer-Fall Deaths.** How could so many animals, washed far north by rivers, get buried *and preserved* in hard, frozen muck? Even if flooding rivers buried mammoths under sediments that permanently froze the following winter, their bodies would have decayed after a summer or fall death. Besides, river flooding usually occurs in the spring, not late summer or fall, and rivers do not deposit muck. The organic component in muck would separate and float to the surface.

50. 🟡 **Upright.** Mammoths, transported by rivers, would not be deposited upright, as some were.

51. 🟡 **Other/Fossils.** No fossils of marine animals have been reported in deposits containing frozen mammoths.¹⁶²

52. 🟡 **Other/South.** Frozen mammoths are not from the south, because their teeth and tusks differ considerably from those found in southern Siberia.

53. 🟡 **Other/Float.** Cold Siberian and Alaskan rivers would minimize the buildup of gas in a decaying carcass. This is why “bodies ordinarily do not float in very cold water.”¹⁶³ Even if these remains floated for hundreds of miles, why were some found along very short rivers flowing directly into the Arctic Ocean?¹⁶⁴ Why was their long hair not worn off? Why were frozen mammoths found on the New Siberian Islands in the Arctic Ocean, more than 150 miles from the mainland? Their bones do not show the wear associated with transport or water

erosion. If an unusually strong river carried floating carcasses to these islands, the carcasses should have been found only along beaches. Instead, remains are found in the interior of islands, the largest of which is 150 miles long and 75 miles wide.¹⁶⁵

54. ● Other/Alaskan Rivers. Parts of six frozen mammoths have been found in Alaska, far from where rivers could originate even if temperatures were warm.

55. ● Other/Swimmers. Elephants are, and presumably mammoths were, excellent swimmers.

Details Relating to the Extinction-by-Man Theory

56. ✘ Abundant Food. There is little precedent for believing that man would push any animal population into a harsh environment having little food. Only Dima, a baby, appeared underfed. Most frozen mammoths that were complete enough to evaluate were well fed.

57. ● Yedomas and Loess, ✘ -150°F, ✘ Large Animals, ● Vertical Compression. The extinction-by-man theory does not explain the relationship between mammoths, yedomas, and loess, the sudden drop in temperature to -150°F, the vertical compression found in Dima and Berezovka, or the preservation of larger, harder-to-freeze animals.

58. ● Elevated Burials. Even if man pushed these animals north into Siberia and Alaska, why would a disproportionate number be buried on the higher elevations of generally flat plateaus?

59. ✘ Rock Ice. With this theory, one would expect Type 1 or 2 ice, not Type 3 ice.

60. ✘ Frozen Muck. If man killed the mammoths, how were mammoths and forests buried under frozen muck? Where did so much muck come from?

61. ● Suffocation. If humans killed mammoths and rhinoceroses, why did at least five suffocate?

62. ✘ Dirty Lungs, ✘ Peppered Tusks. Being hunted by man would not explain silt, clay, and small gravel particles in Dima's respiratory and digestive tracts or millimeter-size particles embedded in mammoth tusks.

63. ✘ Animal Mixes. Mammoth remains are often found near bones of animals that man would probably not have simultaneously pursued, such as: rhinoceroses, horses, tigers, badgers, bears, wolves, hyenas, lynxes, etc. Why would a hunted horse be frozen?¹⁶⁶ Today, wild horses live only in mild climates.

64. ✘ Upright. Mammoths killed by man would not be found standing up, especially in muck.

65. ● Other/No Human Signs. One doubts that primitive man could have exterminated the formidable, even dangerous, mammoth in a remote, frigid, and vast region. Yes, man almost exterminated the less-imposing buffalo—with guns in a temperate climate. No human remains (even bones or teeth), no weapons (arrows or knives), and no other artifacts (pottery, utensils, or art) have been found alongside frozen mammoth and rhinoceros remains. Besides, most primitive arrows and spears would do little damage after penetrating the mammoth's thick skin and fat layers. Nor are the distinctive marks of man's ax or knife clearly seen on mammoth bones and ivory. If man exterminated mammoths, some signs of human activity should occasionally be found among the millions of mammoth remains. To capture or kill large animals, humans often dig deep pits, which would be difficult in permafrost.

66. ● Other/Unpopulated. Humans in today's heavily populated areas might try to exterminate mammoths and rhinoceroses. But why would man do this thousands of years ago in barren and sparsely populated regions of northern Siberia?

67. ● Other/Logic. Humans do not travel to desolate regions for food, especially food difficult to preserve and transport. Even if man occupied these regions, less dangerous and more desirable game would have been available. In Africa today, man has no great desire for elephant or rhinoceros meat. In fact, before the day of the rifle and the ivory market, man generally avoided these huge African animals. If man killed mammoths for their ivory tusks, why were so many tusks left behind? Why would man kill rhinoceroses?

68. ● Other/DNA Shift. Corings into the Siberian permafrost have shown a sudden change in DNA with depth. Below a certain level, DNA is from mammoths and lush, temperate vegetation. Above that level, the DNA matches Siberian vegetation today. As one writer concluded:

The DNA documents a dramatic shift from a landscape of mostly herbaceous plants to dominant shrubs and mosses. ... This lends credibility to the idea that environmental change associated with climatic events was responsible [for the extinction of the mammoth], not human hunting, as many have claimed.¹⁶⁷

69. ● Other/South. Same as item 52.

Details Relating to the Bering Barrier Theory

70. ✘ Abundant Food, ● Warm Climate. This theory places the mammoth's extinction at the peak of the last Ice Age when northern Siberia and Alaska had a colder climate and even less vegetation. During the dark, winter months, food and drinking water would not have been

available inside the Arctic Circle, and yet mammoths were well fed. Many animal and plant species buried there live only in temperate climates today.

71. ● *Yedomas and Loess*. Soils washed down on top of ice would show stratification and some sorting of particles by size. Loess consists of unstratified particles. In yedomas, ice and loess are mixed. Besides, yedomas contain too much carbon.

72. ● *Multi-Continental*, ⊗ *-150°F*, ● *Vertical Compression*. The Bering barrier theory does not explain why these peculiar events occurred over such wide areas on three continents, the rapid drop in temperature to -150°F , or the vertical compression found in Dima and Bere-zovka.

73. ● *Rock Ice*. This theory might explain Type 2 ice near mammoths, but it does not explain rock ice (Type 3 ice).

74. ⊗ *Frozen Muck*. If a gigantic snow storm buried many mammoths, why are almost all carcasses encased in frozen muck? Where does so much muck come from, and why are forests buried under muck?

75. ● *Suffocation*. Large animals caught in a sudden snow storm would die of starvation and exposure, not suffocation.

76. ● *Dirty Lungs*, ⊗ *Peppered Tusks*. Sudden snowfalls would remove dust from the air and bury other dirt particles under a blanket of snow. How then did silt, clay, and gravel enter Dima's digestive and respiratory tracts, and how did "shrapnel" become embedded in hard tusks?

77. ● *Large Animals*. Sudden snow storms would preferentially entomb and freeze smaller animals, because they have less internal heat per unit surface area.

78. ● *Other/Winds*. Prevailing winds at the Bering Strait blow to the east. Therefore, storms from the Pacific should dump snow primarily on Alaska, not Siberia. However, 90% of all known frozen mammoths and all known frozen rhinoceroses are in Siberia.

Details Relating to the Mild Ice Age Theory

79. ⊗ *Abundant Food*, ● *Multi-Continental*, ⊗ *Warm Climate*. Same as item 70.

Without explaining **how**, Michael Oard,¹²⁹ the author of this theory, claims that Siberia and Alaska must have had "mild winters" and little or no permafrost, because those normally frigid lands contain carcasses, abundant bones, large trees in growth positions, and insects and other animals that live in warmer climates.¹⁶⁸ "Mild winters," a phrase Oard uses often, would still be deadly winters in Siberia and Alaska. Sustained and unseasonably warm

winter days *and nights* are required—without a single exception in 700 years. Are "mild winters" reasonable at those high latitudes during the peak of the Ice Age?

How does food grow in a vast, barren wilderness during the long, dark winter? Each of the millions of mammoths required hundreds of pounds of suitable vegetation daily. Today's bog vegetation is unsuitable and insufficient. Why didn't earlier, milder dust storms—as during America's Dust Bowl Era—destroy the mammoth's food supply? Also, Oard's logic avoids the catastrophic implications seen across a 3,000-mile stretch of three continents. [See "**Geographical Extent**" on page 274.]

80. ⊗ *Yedomas and Loess*, ⊗ *Peppered Tusks*. Dust and snow storms would not embed "shrapnel" in mammoth tusks or deposit the vast amount of carbon and organic matter found in yedomas, especially inside the Arctic Circle during the Ice Age. Also, loess is qualitatively different from storm-generated dust. Loess particles are angular, giving them the ability to form vertical surfaces, such as in cliffs, loess dwellings, and furniture. [See **Figure 163 on page 277**.] Most dust particles are rounded by years of erosion. What was the source of so much loess?

81. ● *Rock Ice*. Same as item 73.

82. ● *Frozen Muck*. This theory does not explain why 4,000-foot layers of muck have been found. If even a few hundred of feet of blowing dust accumulated in some places, that dust would have prevented the erosion of more dust directly below. Why would so much vegetation be mixed in the blowing dust?

83. ⊗ *Sudden Freezing*. Snow and dust are excellent insulators, because they trap so much air. Large animals suddenly buried in thick layers of snow and dust would be insulated from the cold atmosphere. Their residual body heat would promote decay, delay freezing, and hinder preservation. [See Hoyle's comments on page 286.]

84. ● *Suffocation*. Large animals killed in sudden snow or dust storms would die from exposure and starvation, not suffocation.

85. ⊗ *-150°F*. Sudden storms that drop temperatures to -150°F are unheard of, even in Antarctica. [See "**Why Did It Get So Cold So Quickly**" on page 280.] If temperatures at the peak of the Ice Age (700 years after the flood) were that severe, why didn't the mammoths (and other temperate animals buried nearby) die centuries earlier by starvation when temperatures were warmer than -150°F but still deadly cold?

According to this theory, the greatest temperature differences between oceans and continents would have been soon after the flood, not 700 years later, after the

oceans had cooled. Storm intensities would have diminished during those 700 years. Mammoths, and the other temperate animals found with them, attempting to migrate from the “mountains of Ararat” to their present graveyards, should have died before they reached their destination and before 700 years had passed—long before the mammoth population increased to 10 million.

86. ● Large Animals. Same as item 77.

87. ● Summer-Fall Deaths. Oard acknowledges that most of the known times of deaths were in the late summer or early fall, even though the most dangerous season in Siberia and Alaska is winter, especially during the Ice Age.

88. ● Vertical Compression. Burial in a dust storm should not produce—before or soon after death—the vertical compression, crushing, and bleeding found in Berezovka.

89. ● Other/Migration to North America. How did mammoths migrate from Siberia to North America? Oard argues that the maximum volume of ice stored on the continents during the Ice Age was much less than most experts estimate. (Their estimates, if correct, would lower today’s sea level 300–400 feet, enough to open a wide land bridge at the Bering Strait.)¹⁶⁹ Oard admits the difficulty he has explaining the migration,¹⁷⁰ but believes that at the peak of the mild Ice Age, a narrow land bridge briefly opened.¹⁷¹ At another point, he claims that “... mammoths and other animals had thrived and migrated over the entire Northern Hemisphere *at the beginning of the Ice Age.*”¹⁷² [emphasis added] (The hydroplate theory and simple geometry explain *why* sea level following the flood was *much lower*, making migrations between Asia and the Americas possible for a few centuries and creating the land bridge at the Bering Strait more than 1,000 miles wide.)

90. ● Other/Deep Freezing. If the present cold temperatures of Siberia and Alaska began after a global flood about 5,000 years ago, trees and soil 1,900 feet below the Earth’s surface would not have had time to freeze, and the buried trees should have decayed. However, if pre-flood forests were buried in extremely cold, muddy hail at the beginning of the flood, as explained by the hydroplate theory, the deep frozen forests and soil, described on page 272, would be explained.

91. ● Other/Cold Winds. This theory claims that a warm Arctic Ocean would produce warm winds that would make Siberia and Alaska tolerable. Actually, a warm Arctic Ocean would have the opposite effect. Strong updrafts over the Arctic Ocean would pull cold air from the surrounding continents in over coastal regions.

92. ● Other/Population Increase. It is doubtful that mammoths and their young migrated 4,500 miles from “the mountains of Ararat” to Siberia during the Ice Age and increased their numbers to 10 million—all in just 700 years. Where have such large animals, that did not need to migrate, ever increased their numbers that much and that quickly, even in a favorable environment? Extrapolating population growth rates and appealing to geometric progressions overlooks the requirements for abundant food, liquid water, and temperate habitats. Obviously, photosynthesis does not occur inside the Arctic Circle in the dead of winter, Ice Age or no Ice Age.

Details Relating to the Shifting Crust Theory

93. ● Yedomas and Loess, ● Peppered Tusks, ● -150°F, ● Large Animals, ● Vertical Compression. The shifting crust theory does not explain why mammoths, yedomas, and loess are related, why yedomas contain so much carbon, why temperatures suddenly drop to -150°F, why primarily the larger, harder-to-freeze animals were frozen and preserved, why “shrapnel” was embedded in mammoth tusks, or why Dima and Berezovka were compressed vertically.

94. ● Rock Ice. Same as item 73.

95. ● Frozen Muck. Same as item 74.

96. ● Summer-Fall Death. Sliding the entire Earth’s crust would produce ruptures in both Northern and Southern Hemispheres. Volcanic activity and storms should have been equally intense and nearly simultaneous in both hemispheres. Because this catastrophic event probably occurred in July, August, or September, summer storms should have occurred in the Northern Hemisphere and winter storms in the Southern Hemisphere. Therefore, we should find frozen carcasses in the Southern Hemisphere, not the Northern Hemisphere.

97. ● Other/Wrong Direction. Frozen remains of mammoths and other animals were found in northern Alaska. If the crust shifted so that Hudson Bay moved from the North Pole to its present position, Alaska would not move appreciably northward. Why then would northern Alaska suddenly shift from a temperate to an Arctic climate?

98. ● Other/No Ruptures. If the crust shifted and ruptured, where are the ruptures?

Details Relating to the Meteorite Theory

99. ● Abundant Food, ● Warm Climate. Same as item 70 on page 288.

100. ● *Yedomas and Loess*, ● *Frozen Muck*, ● *Vertical Compression*, ● *Suffocation*. The meteorite theory does not explain why mammoths, yedomas, and loess are related, why yedomas contain so much carbon, where so much muck originated, why muck has sometimes buried forests, why at least some of these huge animals suffocated, or why Dima and Berezovka are compressed vertically.

101. ☒ *Rock Ice*. The meteorite theory might explain why Type 1 ice melted and allowed mammoths to sink into icy bogs, but Type 3 ice is not explained.

102. ☒ *-150°F*. This theory tries to explain a sudden warming trend. It does not explain why temperatures went *suddenly* in the other direction to -150°F.

103. ☒ *Animal Mixes*. A sudden warming at the end of the Ice Age might have caused some animals “to blunder to their deaths in icy bogs.”¹⁷³ It does not explain why this happened to so many different types of animals that are quick, surefooted, or mobile (such as birds).

104. ● *Other/No Burial*. The rapid jump in atmospheric temperature required to melt permafrost to a depth necessary to bury 13-foot-tall mammoths would have incinerated their bodies.

Were Mammoths Frozen after the Flood?

A few people believe that mammoths were frozen and buried *after* the flood. They give three arguments.

1. *Postflood carvings of mammoths are found on cave walls in France.*

[Response: Some mammoths survived the flood, multiplied, and were seen by humans centuries later.]

2. *Mammoth remains are recent, because they are found near the top of the ground.*

[Response: Don't confuse elevation with time. Deep excavation is difficult and rare in these permafrost regions where mammoth flesh could be preserved. Besides, each year frozen mammoths are uncovered in gold mines, but seldom reported.⁵¹ I know of no frozen mammoth or rhinoceros remains lying directly above layered strata containing marine fossils, oil, coal seams, or limestone.¹³⁸ (See Prediction 26 on page 283.) Those who have searched for such deposits below frozen mammoths have found none.]

3. *Most fossils buried during the flood had their organic material replaced by minerals. Only a few mammoth bones and ivory have experienced this mineral replacement.*

[Response: This is what one would expect. During and long after the flood, warm, mineral-rich waters soaked

into most buried organic tissue. As the water slowly cooled, dissolved minerals were forced out of solution, replacing organic tissue. The frozen mammoth remains in Siberia and Alaska were buried in muddy ice, not liquid water. To understand why the flood waters were warm and mineral-rich, see page 127.]

Final Thoughts

Earth science students are frequently discouraged from considering alternative explanations such as we have examined concerning the frozen mammoths. ***Too often, students are told what to think, not taught how to think critically.*** Why is this?

Before the field of geology began in the early 1800s, a common explanation for major geological features was a global flood. Early geologists were hostile to such explanations for three reasons. First, many geologists were opposed to the Bible, which spoke of a global flood. Second, flood explanations seemed, and sometimes were, scientifically simplistic. Finally, because a global flood is an unrepeatable catastrophe, it cannot be studied directly.

Instead of appearing closed-minded by disallowing flood explanations, a more subtle approach was simply to disallow global catastrophes. This rationale was more justifiable, because modern science requires experimental repeatability. By definition, catastrophes are large, rarely repeated, and difficult to reproduce. The flaw in this exclusionary logic is that catastrophes can occur, involve many phenomena, and leave widespread wreckage and strange details that require an explanation. (You have seen many relating to frozen mammoths.) Most of these phenomena are testable and repeatable on a smaller scale. Some are so well tested and understood that mathematical calculations and computer simulations can be made at any scale.

How were catastrophes disallowed? Professors in the new and growing field of geology were primarily selected from those who supported the anticatastrophe doctrine. These professors did not advance students who espoused catastrophes. An advocate of a global flood was branded a “biblical literalist” or “fuzzy thinker”—not worthy of an academic degree. Geology professors also influenced, through the peer review process, what papers could be published. Textbooks soon reflected their orthodoxy, so few students became “fuzzy thinkers.” This practice continues to this day, because a major criterion for selecting professors is the number of their publications.

This anticatastrophe doctrine is called *uniformitarianism*. Since 1830, it has been summarized by the phrase, “The present is the key to the past.” In other words, only processes observable today and acting at present rates can be used to explain past events. Because some catastrophes,

such as large impacts from outer space, are now fashionable, many now recognize uniformitarianism as a poor, arbitrary assumption—a stifling requirement.¹⁷⁴

This presents geologists with a dilemma. Because uniformitarianism is foundational to geology, should the entire field be reexamined? Uniformitarianism was intended to banish the global flood. Will the death of uniformitarianism allow scholarly consideration of evidence that implies a global flood? Most geologists object to such a possibility. They either deny that a problem exists or hope it will go away. Some try to redefine uniformitarianism to mean that only the laws of physics observed today can be used to explain past geological events—an obvious principle of science long before uniformitarianism was sanctified. [See Endnote 22 on page 211.] The problem will not go away, but will fester even more until enough geologists recognize that catastrophes were never the problem. Early geologists simply, and arbitrarily, wanted to exclude the global flood, not catastrophes.¹⁷⁵

Ruling out catastrophes in general (and the flood specifically), even before all facts are in, has stifled study and understanding. The “frozen mammoth issue” is one of many examples. Disallowing catastrophes also produces a mind-set where strange observations are ignored, or considered unbelievable—not viewed as possibly important *diagnostic details* worthy of our testing and consideration.

Table 12 on page 281 is a broad target for anyone who wishes to grapple with ideas. Notice that it invites, not suppresses, critiques. All theories should be subject to analysis, critique, and refinement. We can focus on the more likely theories, on any misunderstandings or disagreements, on diagnostic details that need further verification, and on the expensive process of testing predictions. With theories and their predictions clearly enumerated, field work becomes more exciting and productive. Most important, those who follow us will have something to build upon. They will not be told what to think.

References and Notes

1. Valentina V. Ukraintseva, *Vegetation Cover and Environment of the “Mammoth Epoch” in Siberia* (Hot Springs, South Dakota: The Mammoth Site of Hot Springs, 1993), pp. 12–13.
 - ◆ N. A. Dubrovo et al., “Upper Quaternary Deposits and Paleogeography of the Region Inhabited by the Young Kirgilyakh Mammoth,” *International Geology Review*, Vol. 24, June 1982, p. 630.
 2. R. Dale Guthrie, *Frozen Fauna of the Mammoth Steppe* (Chicago: The University of Chicago Press, 1990), p. 9.
 3. S. Keith Eltringham, *Elephants*, editor Jeheskel Shoshani (Emmaus, Pennsylvania: Rodale Press, 1992), p. 102.
 4. Some people split mammoths into various species, such as *Mammuthus primigenius* (woolly mammoth) and *Mammuthus columbi* (Columbian mammoth). *Members of a species can interbreed with each other, but not with others.* Obviously, no one can say that the woolly mammoth could not produce offspring with the Columbian mammoth or that the Columbian mammoth did not have a hairy coat similar to that of the woolly mammoth. Their differences were slight. Artificially “creating” new species without some genetic or experimental justification seems unwise.
- Although African and Asian elephants are categorized as different species, on at least one occasion they interbred successfully. (Unfortunately, that offspring died ten days after birth.) Therefore, African and Asian elephants should not be regarded as different species. If they occupied the same territory, no doubt other hybrids would be born.
- ◆ According to *Webster’s Third New International Dictionary* (Unabridged; 1964 edition, p. 1369), the word “mammoth” comes from “mamma,” which means “earth” to the Yakut people of northeastern Siberia. “Mammoth” also relates to the word “behemoth” used in Job 40:15 to describe a huge animal. See:
 - ◆ Henry H. Howorth, *The Mammoth and the Flood* (London: Samson Low, Marston, Searle, and Rivington, 1887), pp. 2–4, 74–75.
 - ◆ A. E. Nordenskiöld, *The Voyage of the Vega Round Asia and Europe*, translated from Swedish by Alexander Leslie (New York: Macmillan and Co., 1882), p. 302.
 - ◆ Willy Ley, *Exotic Zoology* (New York: The Viking Press, 1959), p. 152.
 - 5. E. Ysbrants Ides, *Three Years [of] Land Travels from Moscow Over-Land to China* (London: W. Freeman, 1706) English edition. In 1692, Russia’s Czar Peter the Great directed Ides to explore the vast eastern region of Russia. The natives told Ides (p. 26) that mammoth carcasses were found, “sometimes whole,” “among the hills [yedomas],” along four named rivers and the Arctic coast. The bones in one mammoth’s head were “somewhat red, as tho’ they were tintured with blood” and a forefoot, cut from a leg, was as big around as a man’s waist.
 - ◆ One of the earliest descriptions of frozen mammoths, written in 1724, was authenticated by Dr. Daniel Gottlieb Messerschmidt, a naturalist sent to Siberia by Czar Peter the Great to inquire, among other things, into the frozen mammoth stories. Although Messerschmidt did not personally see the frozen partial remains, his eyewitness, Michael Wolochowicz, described the find in a short report. The report’s credibility is enhanced by its similarity with many later, thoroughly verified accounts. [See John Breyne, “Observations on the Mammoth’s Bones and Teeth Found

- in Siberia," *Philosophical Transactions of the Royal Society of London*, Vol. 40, January–June 1737, pp. 125–138.]
6. E. W. Pfizenmayer, *Siberian Man and Mammoth*, translated from German by Muriel D. Simpson (London: Black & Son Limited, 1939), p. 4.
 7. Howorth, p. 76.
 8. Basset Digby, *The Mammoth* (New York: D. Appleton and Co., 1926), pp. 17–18, 79.
 9. Five expeditions occurred in the 1970s, two in the 1980s, one in 1990, and one in 1999.
 10. Ukraintseva, pp. 80–98.
 - ◆ Guthrie, pp. 10, 30–32.
 11. *Science News Letter*, Vol. 55, 25 June 1949, p. 403.
 12. John Massey Stewart, "Frozen Mammoths from Siberia Bring the Ice Ages to Vivid Life," *Smithsonian*, 1977, p. 67.
 13. N. K. Vereshchagin and G. F. Baryshnikov, "Paleoecology of the Mammoth Fauna in the Eurasian Arctic," *Paleoecology of Beringia*, editors David M. Hopkins et al. (New York: Academic Press, 1982), p. 276.
 14. Harold E. Anthony, "Nature's Deep Freeze," *Natural History*, Vol. 58, September 1949, p. 300.
 15. Michael R. Zimmerman and Richard H. Tedford, "Histologic Structures Preserved for 21,300 Years," *Science*, Vol. 194, 8 October 1976, pp. 183–184.
 16. Stewart, p. 68.
 17. Charles H. Eden, *Frozen Asia* (New York: Pott, Young & Co., 1879), pp. 97–100.
 18. A. G. Maddren, "Smithsonian Exploration in Alaska in 1904 in Search of Mammoth and Other Fossil Remains," *Smithsonian Miscellaneous Collections*, Vol. 49, 1905, p. 101.
 19. W. H. Dall, "Presentation to the Biological Society of Washington," *Science*, 8 November 1895, pp. 635–636.
 20. N. A. Transehe, "The Siberian Sea Road: The Work of the Russian Hydrographical Expedition to the Arctic 1910–1915," *The Geographical Review*, Vol. 15, 1925, p. 392.
 21. Adrian Lister and Paul Bahn, *Mammoths* (New York: Macmillan, 1994), p. 46.
 22. A. P. Vinogradov et al., "Radiocarbon Dating in the Vernadsky Institute I–IV," *Radiocarbon*, Vol. 8, 1966, pp. 320–321.
 23. Robert M. Thorson and R. Dale Guthrie, "Stratigraphy of the Colorado Creek Mammoth Locality, Alaska," *Quaternary Research*, Vol. 37, March 1992, pp. 214–228.
 24. Richard Stone, "Mammoth Hunters Put Hopes on Ice," *Science*, Vol. 291, 12 January 2001, pp. 229–230.
 25. Howorth, pp. 50–54.
 26. Ley, p. 169.
 27. I. P. Tolmachoff, *The Carcasses of the Mammoth and Rhinoceros Found in the Frozen Ground of Siberia* (Philadelphia: The American Philosophical Society, 1929), p. 71.
 28. Maddren, p. 60.
 29. Eske Willerslev et al., "Diverse Plant and Animal Genetic Records from Holocene and Pleistocene Sediments," *Science*, Vol. 300, 2 May 2003, pp. 791–795.
 - ◆ "... climate change played a big role in the mass extinction of mammoths, ground sloths, and other large North American mammals ..." Erik Stokstad, "Ancient DNA Pulled from Soil," *Science*, Vol. 300, 18 April 2003, p. 407.
 30. H. Neuville, "On the Extinction of the Mammoth," *Annual Report of the Smithsonian Institution*, 1919, p. 332.
 31. Nikolai K. Vereshchagin and Alexei N. Tikhonov, *The Exterior of Mammoths* (Yakutsk, Siberia: Merelotovedenia Institute, 1990), p. 18. (Russian)
 - ◆ Pfizenmayer, p. 162.
 - ◆ Hair on the rhinoceros leg also hung to the feet. [See Eden, pp. 99–100.]
 32. Richard B. Firestone et al., "Evidence for an Extraterrestrial Impact 12,900 Years Ago That Contributed to the Megafaunal Extinctions and the Younger Dryas Cooling," *Proceedings of the National Academy of Science*, Vol. 104, 9 October 2007, pp. 16016–16021.
 33. <http://news.bbc.co.uk/2/hi/science/nature/7130014.stm>
 34. Hans Krause, *The Mammoth—In Ice and Snow?* (Stuttgart, Germany: self-published, 1978), p. 53.
 35. Neuville, pp. 327–338.
 36. Krause, pp. 51–52.
 37. A comparative study of 350 mitochondrial DNA nucleotides indicates that the mammoth is closely related to the African and Indian elephants. Dima, a woolly mammoth, differed from both African and Indian elephants by only four or five nucleotides. [See Jeremy Cherfas, "If Not a Dinosaur, a Mammoth?" *Science*, Vol. 253, 20 September 1991, p. 1356.] A recent Japanese study extracted longer strands of nuclear DNA, which showed the mammoth to be more closely related to the Indian elephant than the African elephant.
 38. Ralph S. Palmer, "Elephant," *The World Book Encyclopedia*, Vol. 6 (Chicago: Field Enterprises Educational Corporation, 1973), pp. 178, 178d.
 39. Cynthia Moss, *Elephants*, editor Jeheskel Shoshani, (Emmaus, Pennsylvania: Rodale Press, 1992), p. 115.
 40. Harold Lamb, *Hannibal: One Man Against Rome* (New York: Doubleday & Co., Inc., 1958), pp. 83–108.
 41. Redmond, p. 27.
 42. Redmond, p. 42.
 43. Digby, p. 151.

44. Anonymous, "Much About Muck," *Pursuit*, Vol. 2, October 1969, p. 69.
45. Stewart, p. 68.
46. Redmond, p. 19.
47. Some have speculated that an asteroid struck the Earth and tipped its axis, so mammoths were suddenly at Arctic latitudes. Seldom considered are the Earth's gigantic polar moment of inertia and angular momentum. For an impactor to tip such a stable body more than 5 degrees would require a massive and fast asteroid striking Earth at a favorable glancing blow. The resulting pressure pulse would pass through the entire atmosphere and kill almost all air-breathing animals. This proposal also overlooks the question of the origin of asteroids. [See pages 337–374.]
48. Guthrie, p. 84.
49. Anonymous, "Much About Muck," pp. 68–69.
50. Lindsey Williams, *The Energy Non-Crisis*, 2nd edition (Kasilof, Alaska: Worth Publishing Co., 1980), p. 54.
51. Lister and Bahn, p. 47.
52. R. Lydekker, "Mammoth Ivory," *Annual Report of the Board of Regents of the Smithsonian Institution for the Year Ending June 30, 1899* (Washington, D.C.: Government Printing Office, 1901), pp. 361–366.
53. Vera Rich, "Gone to the Dogs," *Nature*, Vol. 301, 24 February 1983, p. 647.
54. Two very similar accounts describe this discovery. [See Digby, pp. 97–103, or William T. Hornaday, *Tales from Nature's Wonderlands* (New York: Charles Scribner's Sons, 1926), pp. 32–38.] The latter was translated from a Russian report held in the American Museum of Natural History.
55. Ages of mammoths, elephants, and mastodons can be estimated by counting the rings in their tusks. This method was first used on Berezovka. [See Vereshchagin and Tikhonov, p. 17.] Some scientists question whether one ring always implies one year.
56. Peter the Great, Russia's most famous and influential czar, founded this museum and initiated formal mammoth studies. His strong interest in science, and mammoths in particular, led in 1714 to the systematic study and exhibition in St. Petersburg of unusual and exotic animals.
57. O. F. Herz, "Frozen Mammoth in Siberia," *Annual Report of the Board of Regents of the Smithsonian Institution* (Washington, D.C.: Government Printing Office, 1904), pp. 617, 620, 622.
- ◆ Digby, pp. 123, 126, 131.
58. Personal communication with Alexei N. Tikhonov, zoologist and mammoth specialist at the Zoological Institute, Russian Academy of Sciences, St. Petersburg, 12 November 1993.
59. Pfizenmayer, p. 104.
60. Vereshchagin and Tikhonov, p. 17.
61. Herz, p. 623.
- ◆ Digby, p. 182.
62. Jeheskel Shoshani, *Elephants* (Emmaus, Pennsylvania: Rodale Press, 1992), pp. 79, 80, 97.
63. Readers may want to consider other explanations for the crushed leg bone, such as impacts or pinching forces perpendicular to the crushed bone. The flesh surrounding the bone was not visibly mangled, and the leg was still in its shoulder socket. Axial compression might crush a short, weak beam. However, to crush a long beam requires considerable lateral support.
64. Animals are amazingly designed to survive by regulating internal functions during a crisis. For example, all organs require oxygen. Some organs, such as the brain or heart, have a more critical need for oxygen than other body parts. So, when the mammoths were short on oxygen, their brains reduced the oxygen consumption of lower-priority systems, causing penile erection.
- Specifically, venules lie between the venous capillaries and veins leading back to the heart. Venules contract when certain organs send a message that they are running low on oxygen. These contractions slow the flow of blood through the organs (allowing them to extract more oxygen) and increase the blood pressure upstream from the venules. Capillaries, the penis, and other organs become engorged with blood. [Personal communication with pathologist Dudley A. DuPuy Jr., M.D., 5 August 1995.]
65. Tolmachoff, p. 35.
66. Tolmachoff, p. 57.
67. Guthrie, p. 13.
68. *Proceedings of the Berlin Academy*, 1846, p. 223, cited by Howorth, p. 184.
69. Leopold von Schrenck, *Memoirs of St. Petersburg Academy*, Vol. 17, 1869, pp. 48–49, cited by Howorth, p. 185.
70. William R. Farrand, "Frozen Mammoths and Modern Geology," *Science*, 17 March 1961, p. 734.
71. Ivan T. Sanderson, "Riddle of the Frozen Giants," *Saturday Evening Post*, 16 January 1960, p. 82.
72. A. S. W., *Nature*, Vol. 68, 30 July 1903, p. 297.
73. Lister and Bahn, p. 74.
74. Charles H. Hapgood, *The Path of the Pole* (Philadelphia: Chilton Book Co., 1970), p. 267.
75. Joseph C. Dillow, *The Waters Above: Earth's Pre-Flood Vapor Canopy* (Chicago: Moody Press, 1981), pp. 371–377.
76. Dillow, pp. 380–381.
77. Dillow, pp. 383–396.
78. Sanderson, 1960, pp. 82, 83.
- ◆ When an animal dies and decay begins, decomposing amino acids in each cell produce water that ruins the meat's taste. Water expands as it freezes. If a cell freezes after

enough water has accumulated, the expansion will tear the cell, showing that a certain amount of time elapsed between death and freezing. This characteristic was absent in the Berezovka mammoth, and the meat was edible—at least for dogs. These mammoths must have frozen before much decay occurred.

79. Pfizenmayer, pp. 105–106.
80. *Ibid.*, p. 106.
81. Maddren, p. 60.
82. Pfizenmayer, p. 176.
83. Herz, pp. 613, 615.
84. Howorth, p. 96.
85. Maddren, p. 87.
86. L. S. Quackenbush, “Notes on Alaskan Mammoth Expeditions of 1907 and 1908,” *Bulletin American Museum of Natural History*, Vol. 26, 1 September 1901, pp. 87–127.
 - ◆ Tolmachoff, pp. 51–55.
 - ◆ Herz, pp. 615, 616, 618.
87. Some have called it *fossil ice*. Pfizenmayer, who was on the Berezovka expedition, called it *diluvial ice*. The term “diluvial” refers to the biblical flood (deluge). A common belief among Siberians was that the frozen mammoths were killed and buried during the biblical flood, after which Siberian weather became much colder. So, the term “diluvial” is often associated with buried animals and ice in Siberia. Even today, geologists use the word “diluvium” to refer to glacial deposits, believed in the 1800s to be laid down during Noah’s flood.

Baron Eduard Toll, in the late 1800s, may have been the first to write about this strange ice. He called it *stone ice*. Toll and his three companions disappeared in 1903 while on a mammoth expedition to Bennett Island, an Arctic island off the north coast of Siberia. A rescue attempt failed. Toll’s diary, found on Bennett Island three years later, reported that another frozen mammoth had been discovered (not listed in [Table 10](#)). Few details were given. [See, for example, Digby, p. 147.]
88. Herz, p. 618.
89. Quackenbush, p. 101.
90. W. H. Dall, “Extract from a Report to C. P. Patterson, Supt. Coast and Geodetic Survey,” *American Journal of Science*, Vol. 21, 1881, p. 107.
91. A. S. W., p. 297.
92. Dubrovo et al., pp. 630, 632.
93. An early report of these thick layers of buried ice came from an expedition led by Lieutenant J. C. Cantwell. He concluded that, “*The formation of the remarkable ice-cliffs in the lower country [of northern Alaska] is, however, a geological nut which the writer admits his inability to crack.*” “Ice-Cliffs on the Kowak River,” *National Geographic Magazine*, Vol. 7, October 1896, pp. 345–346. [See also J. C. Cantwell, “Exploration of the Kowak River,” *Science*, Vol. 4, 19 December 1884, pp. 551–554.]

Some, but not all, of these reported ice layers may be the vertical faces of ice wedges. When found along coastlines, the two are easily confused. As the Arctic winter approaches and temperatures drop, the ground contracts, sometimes splitting open with a loud crack. Water later fills the vertical crack, freezes, and forms an ice wedge. Years later, this fracture, which is a vertical plane of weakness, might be exposed along a coastline by the undercutting of waves. The side of the ice wedge, if viewed from a boat far from the coast, might seem to be the edge of a horizontal layer of ice. Only by tracing the ice inland for hundreds of feet can the “ice wedge explanation” be rejected. Dall (p. 107) and Maddren (pp. 15–117) did this.
94. Dall, p. 107.
 - ◆ Maddren, p. 104.
 - ◆ Cantwell, “Ice-Cliffs,” p. 345.
95. Cantwell, “Ice-Cliffs,” p. 346.
96. Pfizenmayer, pp. 89–90.
97. Herz, p. 618.
98. Stewart, p. 68.
99. “*The yedoma deposits could only have been formed by cryogenous-eolian [cold and windy] processes.*” V. K. Ryabchun, “More about the Genesis of the Yedoma Deposit,” *The Second International Conference on Permafrost: USSR Contribution, 13–28 July 1973* (Washington, D.C.: National Academy of Sciences, 1978), pp. 816–817.
100. Adolph Erman, *Travels in Siberia*, Vol. 1 (London: Longman, Brown, Green, and Longmans, 1848), pp. 379–380.
101. Nordenskiöld, pp. 26, 311.
102. Paul A. Colinvaux, “Land Bridge of Duvanny Yar,” *Nature*, Vol. 314, 18 April 1985, p. 581.
103. Ryabchun, p. 817.
 - ◆ S. V. Tomirdiaro, “Evolution of Lowland Landscapes in Northeastern Asia During Late Quaternary Time,” *Paleoecology of Beringia*, editors David M. Hopkins et al. (New York: Academic Press, 1982), pp. 29–37.
104. Elise Kleeman, “Siberian Thaw Releases Methane and Accelerates Global Warming,” *Discover*, January 2006, p. 34.
105. A. I. Popov, “Origin of the Deposits of the Yedoma Suite on the Primor’Ye Floodplain of Northern Yakutia,” *The Second International Conference on Permafrost: USSR Contribution, 13–28 July 1973* (Washington, D.C.: National Academy of Sciences, 1978), p. 825.
106. S. V. Tomirdiaro, “Cryogenous-Eolian Genesis of Yedoma Deposits,” *The Second International Conference on Permafrost: USSR Contribution, 13–28 July 1973* (Washington, D.C.: National Academy of Sciences, 1978), pp. 817–818.

- ◆ Colinvaux, p. 582.
 - ◆ Tomirdiario, “Evolution of Lowlands,” pp. 22–37.
 - ◆ Troy L. Péwé, *Origin and Character of Loesslike Silt in Unglaciated South-Central Yakutia, Siberia, U.S.S.R.*, Geological Survey Professional Paper 1262 (Washington, D.C.: United States Government Printing Office, 1983).
107. John B. Penniston, “Note on the Origin of Loess,” *Popular Astronomy*, Vol. 39, 1931, pp. 429–430.
 - ◆ John B. Penniston, “Additional Note on the Origin of Loess,” *Popular Astronomy*, Vol. 51, 1943, pp. 170–172.
 108. Richard Foster Flint and Brian J. Skinner, *Physical Geology* (New York: John Wiley & Sons, Inc., 1974), p. 190.
 109. Digby, p. 107.
 110. Tolmachoff, p. 51.
 - ◆ “*Experience has also shown that more [and better mammoth bones] are found in elevations situated near higher hills than along the low coast or on the flat tundra.*” Ferdinand von Wrangell, *Narrative of an Expedition to the Polar Sea, in the Years 1820, 1821, 1822, & 1823*, 2nd edition (London: James Madden and Co., 1884), p. 275.
 111. Sanderson, 1960, p. 82.
 - ◆ Tolmachoff, pp. 51, 59.
 112. Tolmachoff, pp. 48, 49.
 113. Don DeNevi, *Earthquakes* (Millbrae, California: Celestial Arts, 1977), pp. 56, 67.
 114. “*Seeds and grasses from the intestines indicate that the mammoth died in autumn.*” Stewart, “Frozen Mammoths from Siberia,” p. 68.
 115. “*It is the grass seeds (the species as yet unidentified) which testify to Dima's death in summer, perhaps even specifically in the month of August.*” John Massey Stewart, “A Baby That Died 40,000 Years Ago Reveals a Story,” *Smithsonian*, 1978, p. 126.
 116. “*The discovery of the ripe fruits of sedges, grasses, and other plants suggest that the mammoth died during the second half of July or the beginning of August.*” Hapgood, p. 268.
 117. Tolmachoff, pp. 26, 56–57.
 - ◆ Howorth, pp. 61, 82–83, 158, 185.
 118. For example, one might ask, “What predictions can the theory of organic evolution make?” Few, if any, although Darwin predicted that the gaps in the fossil record would soon be filled. Obviously, he was wrong. Evolutionists today are quick to explain why they make no predictions. Evolution happens over geologic time—*so slowly* that they cannot see it on a human time scale, even after breeding thousands of generations of many organisms. Yet, when asked why many gaps exist in the fossil record, their typical answer is that evolution happens *so rapidly* that the important fossils are seldom preserved. Unwillingness to make predictions shows a lack of scientific rigor and confidence.

Successful predictions are the best test of a theory's strength and fruitfulness.

119. See “**Rocket Science**” on pages 581–582.
 - ◆ Temperatures in outer space are often misunderstood. For example, a physicist might say the temperature 200 miles above the Earth's surface is 2,000°F. However, a thermometer shielded from the Sun's direct rays, might register a drastically colder -150°F. The confusion results from different definitions of temperature and different ways of transferring heat.

The physicist defines temperature as the average kinetic energy of molecules. Because molecules in the extreme upper atmosphere are heated by the Sun's direct rays, they travel very fast and register a very high temperature. Typically, they travel many miles before colliding with another molecule, so little slows them down. At those altitudes, the air is so thin (only one 100,000,000,000th as dense as air at sea level) that little heat is transferred.

A thermometer 200 miles above the Earth's surface might read a frigid -150°F, because it *radiates* so much heat into far outer space, where the effective temperature is near absolute zero (-460°F). A thermometer warmer than -150°F would radiate more heat into far outer space than it receives from rare impacts of fast air molecules. Consequently, its temperature would drop. Only when the thermometer's temperature drops to -150°F will the heat added by fast gas molecules balance the heat lost by radiation. An astronaut without a heated space suit would “feel” the same temperature as the thermometer.

A fraction of each liquid droplet suddenly expelled into the vacuum of outer space will rapidly—but only partially—evaporate. (The technical term is “flash.”) This cools the liquid, just as perspiring cools our skin. Water's temperature drops about 1°F for every thousandth of its volume that evaporates. This is a strong effect, because the faster (hotter) liquid molecules jump out of the liquid, expending much of the liquid's internal energy. The water does not freeze until it is below its normal freezing point because (a) the water circulates, and (b) the minerals in solution lower the freezing point, just as antifreeze prevents your car's radiator fluid from freezing. Once frozen, evaporation slows greatly. With dirt mixed in the liquid, the ice quickly becomes encrusted and sealed inside some of the dirt left behind; evaporation ceases. This is why comet nuclei still contain much water-ice and are dark in color.
120. Y. N. Popov, “New Finds of Pleistocene Animals in Northern USSR,” *Nature*, No. 3, 1948, p. 76. This is the former Soviet (not the British) journal *Nature*.
121. Tolmachoff, p. 64.
122. Charles Lyell, the most influential founder of modern geology, advocated this theory to explain some frozen mammoths. [See Charles Lyell, *Principles of Geology* (reprint, New York: Verlag von J. Cramer, 1970), pp. 96–99.] Herz also used it to explain the Berezovka mammoth. [See Herz, p. 614.]

123. Tolmachoff, pp. 56, 57.
124. This theory was first proposed by Ides. Middendorff, Lyell, and Bunge favored it in some cases. [See Tolmachoff, pp. viii–ix, 56.]
125. Tolmachoff, p. 66.
126. M. Huc, *Recollections of a Journey through Tartary, Thibet [Tibet], and China, During the Years 1844, 1845, and 1846*. Vol. 2 (New York: D. Appleton & Co., 1852), pp. 130–131.
- ◆ Charles Lyell, *Principles of Geology*, 11th edition, Vol. 1 (New York: D. Appleton and Co., 1872), p. 188. Some earlier editions did not contain this report.
127. Streams, rivers, lakes, and oceans freeze from the top down, because water reaches its maximum density at 39°F—seven degrees *above* its normal freezing point. As cold air further lowers the water's temperature, water defies the behavior of most liquids and expands. This less-dense water “floats” on top of the denser water. Eventually, it freezes into ice, which is even less dense.

Fortunately, water behaves in this unusual way. If water continued to contract as it became colder and froze, as most liquids do, ice would sink. Bodies of water would freeze from the bottom up. Surface water would quickly freeze, then sink. During the summer, the overlying liquid water would insulate the ice and delay its melting. Each winter more ice would collect at the bottom. This would first occur at polar latitudes, but over the years would spread toward the equator as surface ice reflected more of the Sun's rays back into space, cooling the Earth. Sea life would eventually cease. Evaporation and rain would diminish, turning the land into a cold, lifeless desert.

Why would the woolly mammoth, bison, woolly rhinoceros, and horse be attracted to Siberia? Today, Siberia is a barren, blizzard-scoured wilderness. How could the animals have endured the extremely cold winters? What would they eat? Where would the beasts locate the prodigious quantities of water they require when the land is imprisoned in snow and ice. Even the rivers are covered with several feet of ice every winter. Most puzzling of all is how did the mammoths and their companions die en mass and how could they have become encased in the permafrost? Oard, p. 13.

Birds Eye Frozen Foods Company ran the calculations and came up with a staggering -150°F (-100°C). Once again, the scientists were puzzled. How could

such temperatures be reached on earth, especially when they were in a fairly temperate environment before the quick freeze? Oard, p. 14.

*A number of carcasses, as well as a few skeletons, have been discovered in a general **standing position**.* [emphasis in original] Oard, p. 19.

*Strangely, scientists investigating three woolly mammoths and two woolly rhinos, including the Berezovka mammoth, found they all died by **suffocation**.* [emphasis in original] Oard, p. 20.

Mammoths and the many other types of mammals are ill suited for [even] summer conditions in Siberia. What are millions of them doing in Siberia? ... paradoxically, they lived during the Ice Age. ... The bog vegetation that dominates Siberia's summers would provide woefully inadequate nutrition for the well-dressed giants. Oard, pp. 26–27, 51–52.

130. To the best of my knowledge, Michael Oard was the first to publish the proposal that **warm waters coming from under the Earth's crust during the flood contributed to the only Ice Age**. For this, he deserves full credit. [See Michael J. Oard, “A Rapid Post-Flood Ice Age,” *Creation Research Society Quarterly*, Vol. 16, June 1979, pp. 29–37. Also see Michael J. Oard, *An Ice Age Caused by the Genesis Flood* (El Cajon, California: Institute for Creation Research, 1990).]

In 1972, after reading Dolph Earl Hooker's book, *Those Astounding Ice Ages* (New York: Exposition Press, 1958), I reached a similar conclusion. Since 1972, every one of my several hundred lectures on the flood explained how the flood produced the Ice Age—or more precisely, produced an Ice Age each winter for many years after the flood.

In 1976, I flew to the Institute for Creation Research (ICR) and spent a day with Drs. Henry M. Morris, Duane T. Gish, and Harold S. Slusher explaining what I believed happened during and following the flood—including the Ice Age. At the end of the day, Morris urged me to publish the explanation in a technical monograph that ICR would publish. Unfortunately, my family and Air Force responsibilities made that impossible. I also felt that a much more detailed, interdisciplinary study of the mechanisms and consequences of the flood should be completed before anything was published. Primarily for that reason, I retired from the Air Force at the first opportunity, in 1980, and began my present work.

Michael Oard and I agree that the global flood produced the Ice Age, in part because warm flood waters came from inside the Earth. However, Oard overlooks an equally important factor: high and, therefore, *cold continents*. Centuries were required for the crushed, thickened—and, therefore, higher—hydroplates to sink into the mantle. (Each continent was also elevated an additional mile, on average, by a mile-thick layer of flood sediments.) Warm oceans and cold continents produced powerful winds which, in turn, transported vast amounts of moisture up onto the cold continents where snow and ice accumulated.

Oard suggests that the pre-flood subterranean water was 3,000–10,000 feet below the Earth's surface [Oard, *Frozen in Time*, p. 75]. He believes that a deeper source of the flood water would have been too hot for present sea life to have survived. However, water at 3,000–10,000 feet depths would easily and quickly escape to the Earth's surface through the slightest crack, but at depths greater than 5 miles, pressures are so great that rock is sealed like highly compressed putty. [See the technical note, “**Highly Compressed Solids**,” on page 608.] For various reasons, I have estimated that the pre-flood subterranean water was about 60 miles below the pre-flood Earth's surface. Page 126 explains why the hot subterranean waters did not scald the Earth.

Much heat is needed to produce the evaporation needed for the Ice Age. Pages 153–192 explain why that heat was not concentrated in surface water after the flood. Instead, considerable heat was in the voluminous flood basalts, especially those on the floor of the western Pacific. Heat leaked slowly, keeping Pacific waters warm for centuries. Today's El Niños are a small reminder of that process.



PREDICTION 28: General circulation models of the Earth's weather will be able to demonstrate that an ice age would have occurred if warm oceans, vast flood basalts, and high, cold continents once existed.

131. Hapgood, *The Path of the Pole*, 1970, pp. 249–270.
132. Fred Hoyle, *Ice* (New York: The Continuum Publishing Co., 1981), pp. 159, 160.
133. Smaller dirt particles have a much greater ratio of viscous-to-inertial forces acting on them. Thus, the liquid seems more viscous to smaller particles. Sudden movements of the droplet carry the smaller dirt particles with the liquid, while larger particles, which have higher inertial forces, could be thrown out of the liquid.
134. Niels Reeh, “Was the Greenland Ice Sheet Thinner in the Late Wisconsinan Than Now?” *Nature*, Vol. 317, 31 October 1985, p. 797.
 - ◆ R. M. Koerner and D. A. Fisher, “Discontinuous Flow, Ice Texture, and Dirt Content in the Basal Layers of the Devon Island Ice Cap,” *Journal of Glaciology*, Vol. 23, No. 89, 1979, pp. 209–219.
135. P. A. Mayewski et al., “Changes in Atmospheric Circulation and Ocean Cover over the North Atlantic During the Last 41,000 Years,” *Science*, Vol. 263, 25 March 1994, pp. 1747–1751.
136. Besides being salty, rock ice will contain carbon dioxide and many dissolved minerals, will have a crystallographic structure showing that it formed at very low pressures and temperatures, and will have large hydrogen and oxygen isotope variations. Such variations have already been reported at the bottom of ice cores on Devon Island in Arctic Canada. The same ice layer has a high silt content.

[See Koerner and Fisher.] Also, ice cores from Byrd Station in Antarctica contain large oxygen (O^{18}/O^{16}) and hydrogen (H^2/H^1) variations in the bottom half of the ice sheet. [See Samuel Epstein et al., “Antarctic Ice Sheet,” *Science*, Vol. 168, 26 June 1970, pp. 1570–1572.] The bottom ice in some ice wedges in Siberia is abnormally salty. [See Yu. K. Vasilchuk and V. T. Trofimov, “Cryohydrochemical Peculiarities of Ice Wedge Polygon Complexes in the North of Western Siberia,” *Permafrost: Fourth International Conference Proceedings* (Washington, D.C.: National Academy Press, July 17–22, 1983), pp. 1303–1308.]
137. Only the leading edge of the giant mass of falling hail was heated—specifically, the outer surface of each ice particle in that leading edge. These relatively few outer surfaces acted much like an ablative shield that protects a reentering space ship from friction and heat, with two important differences: (a) the ice is very cold, as explained in “**Rocket Science**” on pages 581–582, so a little ice absorbed heat from the atmosphere and became rain, and (b) the ice particles had almost no kinetic energy at the top of their trajectory, but a spacecraft or meteor has a gigantic amount at the same altitude. (Meteors are typically traveling 50,000 miles per hour when they hit the upper atmosphere.) Therefore, little heat was transferred to the atmosphere, and little of a massive glob of ice melted.
138. One geologist, trying to falsify this prediction, drafted an article claiming that a geologic map showed layered, fossil-bearing strata under the Colorado Creek mammoths. He misread his geologic map. Had he read it correctly, he would have seen that it supported this prediction. The article was never published and that geologist has stopped spreading the misinformation.
139. Tolmachoff (p. 51) reported, “*The uppermost position of mammoth-bearing deposits [cover the] sediments of the Arctic transgression ...*” This has caused some confusion in North America where “transgression” means the advance of the sea over the land. Such an advance might deposit sediments and fossils unconformably. To Europeans (and presumably the European-trained Tolmachoff) the term “transgression” simply means an unconformity—basically, dirt that is not layered. [See “transgression,” in Robert L. Bates and Julia A. Jackson, editors, *Glossary of Geology*, 2nd edition (Falls Church, Virginia: American Geological Institute, 1980), p. 660.] In other words, rocks under the mammoths are not stratified. Tolmachoff attributed this to glacial activity, but described nothing showing glacial activity.
140. Digby, p. 93.
141. Troy L. Péwé, *Quaternary Geology*, Geological Survey Professional Paper 835 (Washington, D.C.: United States Government Printing Office, 1975), pp. 41–42.
142. Vereshchagin and Tikhonov, p. 18.
143. N. A. Dubrovo et al., p. 633.
144. *Ibid.*

145. Troy L. Péwé, *Quaternary Stratigraphic Nomenclature in Unglaciated Central Alaska*, Geological Survey Professional Paper 862 (Washington, D.C.: United States Government Printing Office, 1975), p. 30.
- ◆ Guthrie, p. 38.
146. Thorson and Guthrie, p. 222.
147. *Ibid.*, p. 221.
148. One questionable story came from an exhibit of frozen mammoth remains that toured the United States in 1992. The official brochure stated without elaboration, "*Portions of a mammoth thousands of years old that was discovered in permafrost were defrosted, cooked and served at a banquet honoring scientists.*" Hapgood (*The Path of the Pole*, p. 261) made a similar statement but mentioned the name of the man who claimed to have eaten mammoth steak in Moscow in the 1930s.
149. Lydekker, p. 363.
150. Herz, p. 621.
151. Rich, p. 647.
152. Charles Lyell, *Principles of Geology* (New York: Verlag von J. Cramer, reprint edition, 1970), p. 97.
153. Guthrie, pp. 9, 11, 12, 20.
- ◆ Georges Cuvier, *Essay on the Theory of the Earth*, reprint edition (New York: Arno Press, 1978), pp. 274–276.
154. Krause, p. 88.
155. S. Keith Eltringham, *Elephants*, editor Jeheskel Shoshani, (Emmaus, Pennsylvania: Rodale Press, 1992), p. 126.
156. Digby, 171.
- ◆ Charles H. Hapgood, "The Mystery of the Frozen Mammoths," *Coronet*, September 1960, pp. 71–78.
 - ◆ Sanderson, 1960, p. 83.
157. Henryk Kubiak, "Morphological Characters of the Mammoth," *Paleoecology of Beringia*, editors David M. Hopkins et al. (New York: Academic Press, 1982), p. 282.
158. Hoyle, p. 160.
159. Howorth, p. 182.
160. Guthrie, p. 17.
161. Tolmachoff, p. 52.
162. Tolmachoff, p. 52.
163. Hapgood, *The Path of the Pole*, p. 258.
164. Howorth, p. 61.
165. Hapgood, *The Path of the Pole*, p. 257.
166. Guthrie, pp. 30–32.
167. Jocelyn Selim, "Land of the Lost ... and Found," *Discover*, July 2003, p. 11.
168. Oard, *Frozen in Time*, pp. 141–143.
169. *Ibid.*, pp. 91–94.
170. "*The migration of the mammoths into the United States is the main challenge.*" *Ibid.*, p. 140.
171. *Ibid.*, p. 130.
172. *Ibid.*, p. 172.
173. Hoyle, p. 160.
174. "*As is now increasingly acknowledged, however, Lyell [the father of geology] also sold geology some snake oil. He convinced geologists that because physical laws are constant in time and space and current processes should be consulted before resorting to unseen processes, it necessarily follows that all past processes acted at essentially their current rates (that is, those observed in historical time). This extreme gradualism has led to numerous unfortunate consequences, including the rejection of sudden or catastrophic events in the face of positive evidence for them, for no reason other than that they were not gradual.*" Warren D. Allmon, "Post-Gradualism," *Science*, Vol. 262, 1 October 1993, p. 122.
175. See, for example, Rudwick's introduction to Charles Lyell's influential *Principles of Geology* (1830; reprint, Martin J. S. Rudwick, Chicago: The University of Chicago Press, 1990), pp. xvi–xvii. Chapter 3 of Lyell's *Principles* (pp. 21–54) is particularly revealing.

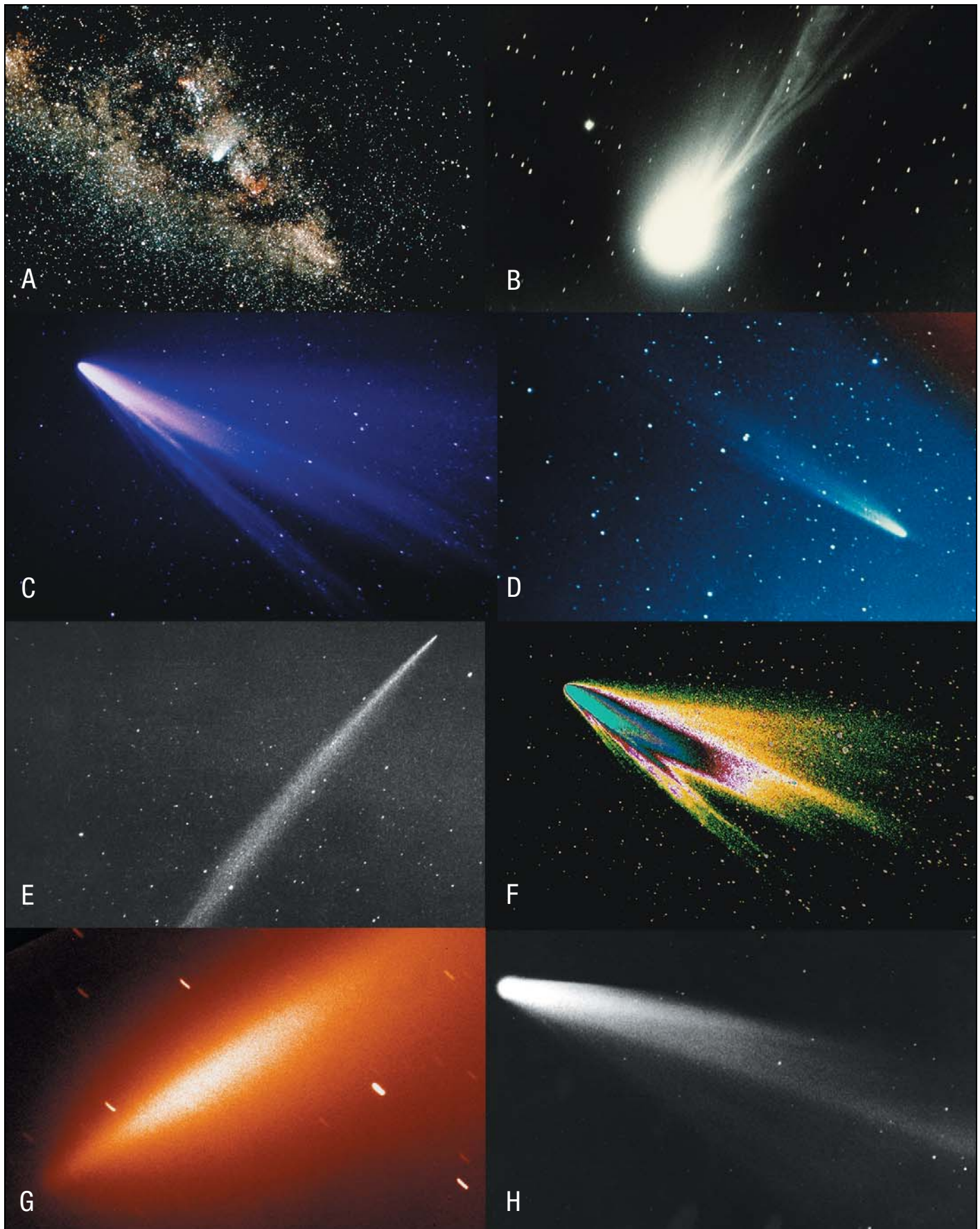

Figure 166: Comets. A) Comet Halley in Milky Way, February 1986; B) Comet Halley, February 1986; C) Comet West, March 1976; D) Comet Kohoutek, June 1973; E) Comet Ikeya-Seki, November 1965; F) Comet West, computer enhanced; G) Comet LINEAR, July 2000; H) Comet Hale-Bopp, March 1997.

The Origin of Comets

SUMMARY: *Past explanations for how comets began have serious problems. After a review of some facts concerning comets, a new explanation for comets will be proposed and tested. During the first weeks of the flood, the fountains of the great deep launched water, rocks, and muddy droplets that later gravitationally merged around the larger rocks. The fountains expelled an “ocean” of high-pressure, supercritical water that jetted up through the atmosphere and into the vacuum of space. Today, these merged bodies match comets in size, number, density, composition, spin, texture, strength, chemistry (organic and inorganic), and orbital characteristics. After a comparison of theories with evidence, problems with the earlier explanations will become obvious.*

Comets may be the most dynamic, spectacular, variable, and mysterious bodies in the solar system. They even contain *complex* organic molecules—including trace amounts of the amino acid glycine, a building block of life on Earth.¹ Early scientists discovered other types of organic matter in comets “similar to organic matter of unquestioned biological origin on Earth,” and concluded that they came from “decomposed organic bodies.”²

While simple organic compounds are not always a product of life, complex organic compounds almost certainly are. Furthermore different comets are expelling multiple organic compounds.³ Today, a popular belief is that comets brought life to Earth. Instead, comets have traces of life from Earth.⁴ [See “**Rosetta Mission**” on p. 309.]

Comets orbit the Sun. When closest to the Sun, some comets travel more than 350 miles *per second*! Others, at their farthest point from the Sun, spend years traveling less than 15 miles per hour. A few comets travel so fast they will escape the solar system. Even fast comets, because of their great distance from Earth, appear to “hang” in the night sky, almost as stationary as the stars. Comets reflect sunlight and fluoresce (glow). They are brightest near the Sun and sometimes visible in daylight.



Figure 167: Arizona's Meteor Crater. Comets are not meteors. Comets are like giant, dirty, exceedingly fluffy “snowballs.” Meteors are rock fragments, usually dust particles, falling through Earth's atmosphere. “Falling stars” streaking through the night sky are usually dust particles thrown off by comets years ago. In fact, every day we walk on comet dust. House-size meteors have formed huge craters on Earth, the Moon, and elsewhere. Meteors that strike the ground are renamed “meteorites,” so the above crater, $\frac{3}{4}$ mile wide, should be called a “meteorite” crater.

On the morning of 14 December 1807, a huge fireball flashed across the southwestern Connecticut sky. Two Yale professors quickly recovered 330 pounds of meteorites, one weighing 200 pounds. When President Thomas Jefferson heard their report, he allegedly said, “It is easier to believe that two Yankee professors would lie than that stones would fall from heaven.” Jefferson was mistaken, but his intuition was no worse than ours would have been in *his* time. Today, many would say, “The Moon's craters show that it must be billions of years old” and “What goes up must come down.” Are these statements common mistakes in *our* time?

As you read this chapter, test such intuitive ideas and alternate explanations against evidence and physical laws. Try to grasp the explosive and sustained power of the fountains of the great deep. (Later chapters will make this even clearer.) You will also see why the Moon is peppered with craters, as if someone had fired large buckshot at it. Comets are “out of this world.”

A typical comet, when far from the Sun, resembles a dirty, misshapen snowball, a few miles across. About 38% of its mass⁵ is frozen water—but this ice is extremely fluffy, with

much empty space between ice particles. The rest is dust and various chemicals. As a comet approaches the Sun, a small fraction of the snowball (or *nucleus*) evaporates, forming a gas and dust cloud, called a *coma*, around the nucleus. The cloud and nucleus together are called the *head*. The head's volume can be larger than a million Earths. Comet *tails* are sometimes more than an *astronomical unit* (AU) long (93,000,000 miles), the average Earth-Sun distance. One tail was 3.4 AU long—enough to stretch around Earth 12,500 times.⁶ Sunlight and solar-wind propel comet tails away from the Sun, so comets traveling away from the Sun move tail-first.

Comet tails are extremely tenuous—giant volumes of practically nothing. Stars are sometimes observed through a comet's head or tail; comet shadows on Earth, even when expected, have never been seen. One hundred cubic miles of comet Halley's tail contains much less matter than in a cubic inch of air we breathe—and is even less dense than the best laboratory vacuum.

In 1998, billions of tons of water-ice mixed with the soil were found in deep craters near the Moon's poles. As one writer visualized it,

*Comets raining from the sky left pockets of frozen water at the north and south poles of the moon, billions of tons more than previously believed, Los Alamos National Laboratory researchers have found.*⁷

Later, thin traces of water were found at all lunar latitudes by three different spacecraft.⁸ Comets are a likely source, but this raises perplexing questions. Ice should evaporate from the Moon faster than comets currently deposit it, so why does so much ice remain?⁹ Also, recently deposited ice has been discovered in permanently shadowed craters on Mercury,¹⁰ the closest planet to the Sun. Ice that near the Sun is even more difficult to explain. [See Figure 168.]

Fear of comets as omens of death existed in most ancient cultures.¹¹ Indeed, comets were called “disasters,” which in Greek means “evil” (*dis*) “star” (*aster*). Why fear comets and not other more surprising celestial events, such as eclipses, supernovas, auroras, or meteor showers? When Halley's comet appeared in 1910, some people worldwide panicked; a few even committed suicide.¹² In Texas, police arrested men selling “comet-protection” pills. Rioters then freed the salesmen. Elsewhere, people quit jobs or locked themselves in their homes as the comet approached.

Comets are rapidly disappearing. Some of their mass is “burned off” each time they pass near the Sun, and they frequently collide with planets, moons, and the Sun. Comets passing near large planets often are torn apart by gravitational effects or receive gravity boosts that fling them, like slingshots, out of the solar system forever. Because we have seen so many comets die, we naturally wonder, “How were they born?”

Textbooks and the media confidently explain, in vague terms, how comets began. Although comet experts worldwide

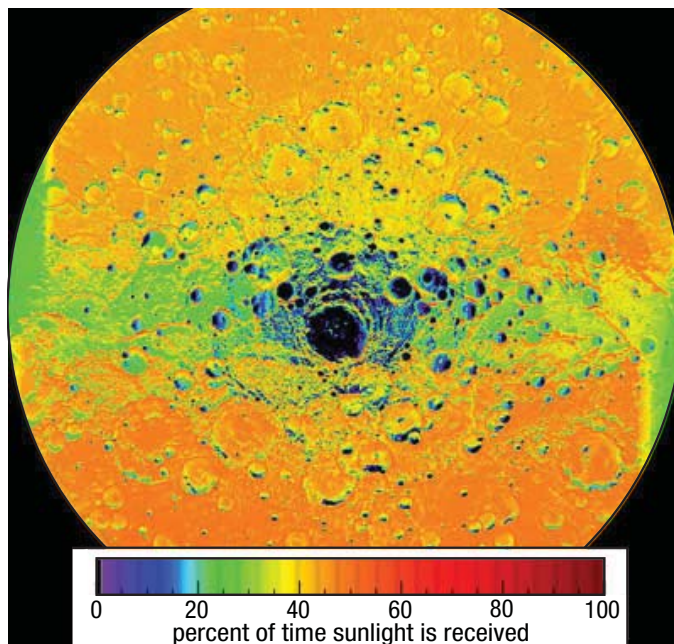

Figure 168: Cold Ice on Hottest Planet. Planet Mercury has an average surface temperature of 350°F! However, layers of water ice, up to a few hundred meters thick, are permanently shielded from sunlight in craters (shown above in black) near Mercury's poles.¹⁰ How strange. How did that water get there—and from where?

That ice could not have been on Mercury for millions of years. Meteoritic impacts would have scattered the ice into the Sun's fiery glow or buried the ice with debris from those impacts. Nor could water have migrated into those craters from inside or on Mercury without becoming hot water vapor (or dissociated H, O, and OH) that would quickly escape into space.

Where did the water come from? Comets and asteroids, which contain vast amounts of water, are not hitting Mercury frequently today, but they may have rapidly bombarded Mercury in the relatively recent past. Obviously, Mercury's water came from some place with considerable water. Could it have been Earth, “the water planet”?

know those explanations lack details and are riddled with scientific problems, most experts view the problems, which few others appreciate, as “future research projects.”

To learn the probable origin of comets, we should:

- Understand these problems. (This will require learning how gravity moves things in space, often in surprising ways.)
- Learn a few technical terms related to comets, their orbits, and their composition.
- Understand and test the seven major theories for comet origins.

Only then will we be equipped to decide which theory best explains the origin of comets.

Gravity: How and Why Most Things Move

Gravity pulls us toward Earth's solid surface. This produces *friction*, a force affecting and slowing every movement we



Figure 169: Nucleus of Halley's Comet. When this most famous of all comets last swung by the Sun in 1986, five spacecraft approached it. From a distance of a few hundred miles, *Giotto*, a European Space Agency spacecraft, took six pictures of Halley's black, 9 x 5 x 5 mile, potato-shaped nucleus. This first composite picture of a comet's nucleus showed 12–15 jets venting gas at up to 30 tons per second. (Venting and tail formation occur only when a comet is near the Sun.) The gas moved away from the nucleus at almost a mile per second to become part of the comet's head and tail. Seconds after these pictures were taken, *Giotto* slammed into the gas, destroying the spacecraft's cameras.

make. Since we were babies, we have assumed that everything behaves this way. Indeed, none of us could have taken our first steps without friction and the downward pull of gravity. Even liquids (such as water) and gases (such as air) create a type of friction called *drag*, because gravity also pulls liquids and gases toward Earth's solid surface.

In space, things are different. If we were orbiting Earth, its gravity would still act on us, but we would not feel it. We might think we were “floating” when, in fact, we would be falling. In a circular orbit, our velocity would carry us away from Earth as fast as we fell.

As another example, in 1965 astronaut James McDivitt tried to catch up (rendezvous) with an object orbiting far ahead of him. He instinctively increased his speed. However, this added speed moved his orbit higher and farther from Earth where gravity is weaker and orbital velocities are slower. Thus, he fell farther behind his target. Had he temporarily slowed down, he would have changed his orbit, lost altitude, sped up, and traveled a shorter route. Only by slowing down could he catch up—essentially taking a shortcut.

All particles attract each other gravitationally. The more massive and the closer any two particles are to each other, the greater their mutual attraction. To determine the gravitational pull of a large body, one must add the effects of all its tiniest components. This seems a daunting task. Fortunately, the gravitational pull of a *distant* body behaves almost as if all its mass were concentrated at its center of mass—as our intuition tells us.

Hollow Shell. But what if we were *inside* a “body,” such as the universe, a galaxy, or Earth? Intuition fails. For example, if Earth were a hollow shell and we were inside, we would “float”! The pull from the side of the spherical shell nearest us would be great because it is close, but more mass would pull us in the opposite direction. In 1687, Isaac Newton showed that the two opposite pulls always balance.¹³

Tides. A water droplet in an ocean tide feels a stronger gravitational pull from the Sun than from the Moon. This is because the Sun's huge mass (27 million times greater than that of the Moon) more than makes up for the Sun's greater distance. However, ocean tides are caused primarily by the Moon, not the Sun. This is because the Sun pulls the droplet *and the center of the Earth* toward itself almost equally, while the much closer Moon pulls relatively more on *either* the droplet *or* the center of the Earth (whichever is nearer). We best see this effect in tides, because the many ocean droplets slip and slide so easily over each other. (To learn more about what causes tides, see page 576.)

Tidal effects act everywhere on everything: gases, liquids, solids—and comets. When a comet passes near a large planet or the Sun, the planet's or Sun's gravity pulls the near side of the comet with a greater force than the far side. This difference in “pulls” stretches the comet and sometimes tears it apart. If a comet passes very near a large body, it can be pulled apart many times; that is, pieces of pieces of pieces of comets are torn apart as shown in Figure 170.

Spheres of Influence. The Apollo 13 astronauts, while traveling to the Moon, dumped waste material overboard. As the discarded material, traveling at nearly the same velocity as the spacecraft, moved slowly away, the spacecraft's gravity pulled the material back. To everyone's surprise, it orbited the spacecraft all the way to the Moon.¹⁴ When the spacecraft was on Earth, Earth's gravity dominated things near the spacecraft. However, when the spacecraft was far from Earth, the spacecraft's gravity dominated things near it. The region around a spacecraft, or any other body in space, where gravity can hold an object in an orbit, is called that body's *sphere of influence*.

An object's sphere of influence expands enormously as it moves farther from massive bodies. If, for many days, rocks and droplets of muddy water were expelled from Earth in a hypersonic jet, the spheres of influence of the rocks and water would grow dramatically. The more the spheres of influence grew, the more mass they would capture, so the more they would grow, etc.¹⁵

A droplet engulfed in a *growing sphere of influence* of a rock or another droplet with a similar velocity might be captured by it.¹⁶ However, a droplet entering a body's *fixed sphere of influence* with even a small relative velocity would seldom be captured, because it would gain enough speed as it fell toward that body to escape from the sphere of influence at about the same speed it entered.

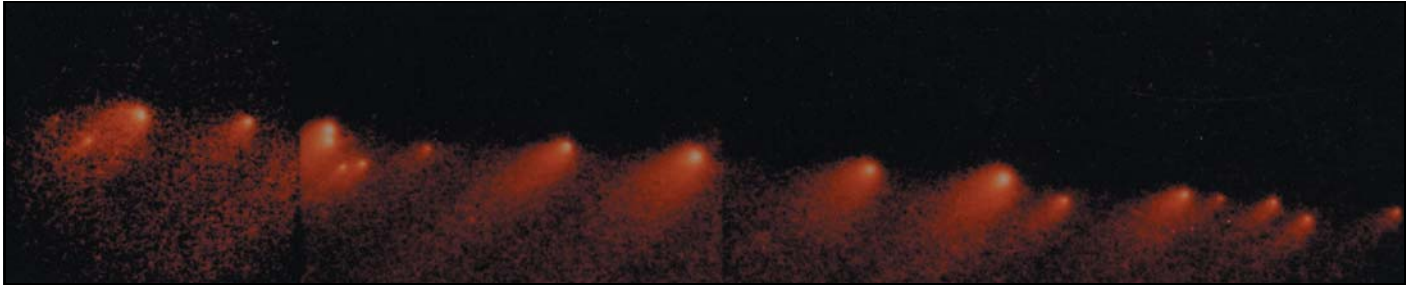

Figure 170: Weak Comets. Tidal effects often tear comets apart, showing that comets have almost no strength. A comet nucleus several miles in diameter could be pulled apart by two humans. In comparison, the strength of an equally large snowball would be gigantic. In 1992, tidal forces dramatically tore comet Shoemaker-Levy 9 into 23 pieces as it passed near Jupiter. Two years later, the fragments, resembling a “flying string of pearls” strung over 180,000,000 miles, returned and collided with Jupiter. A typical high-velocity piece released about 5,000 hydrogen bombs’ worth of energy and became a dark spot, larger than Earth, visibly drifting for days in Jupiter’s atmosphere. We will see that Jupiter, with its huge gravity and tidal effects, is a comet killer.

Earth’s sphere of influence has a radius of about 600,000 miles. A rock inside that sphere is influenced more by Earth’s gravity than the Sun’s. A rock entering Earth’s sphere of influence at only a few feet per second would accelerate toward Earth. It could reach a speed of almost 7 miles per second, depending on how close it came to Earth. Assuming no collisions, gravity would whip the rock partway around Earth so fast it would *exit* Earth’s sphere of influence about as fast as it entered—a few feet per second. It would then be influenced more by the Sun and would enter a new orbit about the Sun.¹⁷

Exiting a sphere of influence is more difficult if it contains a gas, such as an atmosphere or water vapor. Any gas, especially a dense gas, slows an invading particle, perhaps enough to capture it. Atmospheres are often relied upon to slow and capture spacecraft. This technique, called *aerobraking*, generates heat. If the “spacecraft” is a liquid droplet, capture is even easier, because evaporation makes the droplet smaller and the atmosphere denser.

A swarm of mutually captured particles will orbit their common center of mass. If the swarm were moving away from Earth, the swarm’s sphere of influence will grow, so fewer particles would escape by chance interactions with other particles. Particles in the swarm, colliding with gas molecules, would gently settle toward the swarm’s center of mass. How gently? More softly than large snowflakes settling onto a windless, snow-covered field, because the swarm’s gravity is much weaker than Earth’s gravity. Eventually, most particles in this swarm would become a rotating clump of fluffy ice particles with almost no strength. *The entire clump would stick together, resembling a comet’s nucleus in strength, size, density, spin, texture, orbit, and composition—especially molecules from living things on Earth.* The pressure at the center of a comet nucleus 3 miles in diameter is about what you would feel under a blanket here on Earth.

In contrast, spheres of influence hardly change for particles in nearly circular orbits about a planet or the Sun. Colliding particles rarely stick together. Even when particles pass

near each other in empty space, capture does not occur, because their relative velocities almost always allow them to escape each other’s sphere of influence, and their spheres of influence do not expand. Forming stars, planets, moons, or meteoroids by capturing¹⁸ smaller orbiting bodies is far more difficult than most people realize.¹⁹ However, if gases are inside these spheres, capture becomes more likely, and the more particles captured, the larger the sphere of influence becomes.

How Comets Move

Most comets travel on long, oval paths called *ellipses* that bring them near the Sun and then swing them back out into deep space. [See [Figure 176 on page 316.](#)] The point nearest the Sun on an elliptical orbit is called its *perihelion*. At perihelion, a comet’s speed is greatest. After a comet passes perihelion and begins moving away from the Sun, its velocity steadily decreases until it reaches its farthest point from the Sun—called its *aphelion*. (This is similar to the way a ball thrown up into the air slows down until it reaches its highest point.) Then, the comet begins falling back toward the Sun, gaining speed until it again reaches perihelion.

Short-Period Comets. Of the 1,139 known comets, that are in elliptical orbits, 737 orbit the Sun in less than 100 years. They are called *short-period comets*, because the time for each to orbit the Sun once, called the *period*, is short—less than 100 years.²⁰ Short-period comets usually travel near Earth’s orbital plane, called the *ecliptic*. Almost all (711) are *prograde*; that is, they orbit the Sun in the same direction as Earth. Surprisingly, about 60% of all short-period comets have aphelions near some point on Jupiter’s orbit.²¹ They are called *Jupiter’s family*. [See [Figure 172.](#)]

To understand better what is meant by “Jupiter’s family,” look briefly at [Figure 177 on page 318.](#) While comets A, B, and C orbit the Sun, only A and B are in Jupiter’s family, because their farthest points from the Sun, their aphelions, are near Jupiter’s orbit. How Jupiter collected its large family

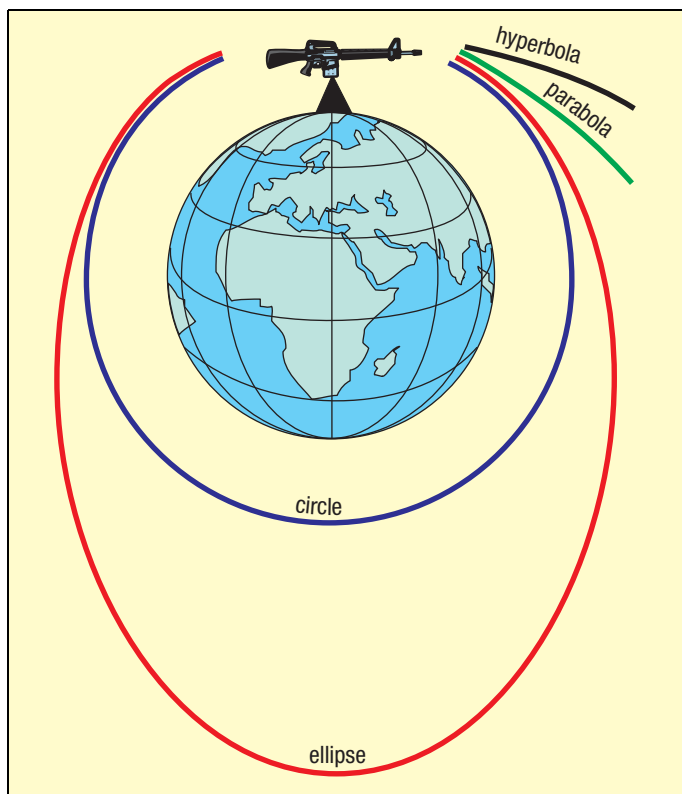

Figure 171: A Shot Fired Around the World. Imagine standing on a tall mountain rising above the atmosphere. You fire a bullet horizontally. If its speed is just right, and very fast, it will “fall” at the same rate the spherical Earth curves away under the bullet. The bullet would have a *circular orbit* (blue) around Earth. Simply stated, the bullet would “fall” around the Earth continually. Isaac Newton first suggested this surprising possibility in 1687. It wasn’t until 1957 that the former Soviet Union demonstrated this with a satellite called *Sputnik I*.

If the bullet were launched more slowly, it would eventually hit the Earth. If the bullet traveled faster, it would be in an oval or *elliptical orbit* (red).²² With enough additional speed, the orbit would not “loop around” and close on itself. It would be an “open” orbit; the bullet would never return. The green orbit, called a *parabolic orbit*, is the boundary between open and closed orbits. With any greater launch velocity, the bullet would travel in a *hyperbolic orbit*; with any less, it would be in an elliptical orbit. These orbits will be discussed in more detail later. Understanding them will help us discover how comets came to be.

of comets presents major problems for most theories for comet origins, because comets falling toward the Sun from the outer solar system would be traveling too fast as they zip inside Jupiter’s orbit. To slow them down, so they could join Jupiter’s family, would require such great deceleration forces that the comets would have to pass very near planets. But those near passes could easily, produce collisions, tear comets apart, or eject them from the solar system.²³

Therefore, comets in Jupiter’s family have a life expectancy of only about 12,000 years.²⁴ This presents three possibilities: (1) Jupiter’s family formed less than about 12,000 years ago, (2) the family is resupplied rapidly by unknown

Table 14. Comet Types and Characteristics

	Types of Comets on Elliptical Orbits		
	Short-Period	Intermediate-Period	Long-Period
Orbital Period	less than 100 years	100–700 years	more than 700 years
Number of Comets	737	104	298
Angle of Inclination to Earth’s Orbital Plane	mostly very low	widely dispersed	widely dispersed
Orbital Direction			
Prograde	97%	58%	53%
Retrograde	3%	42%	47%

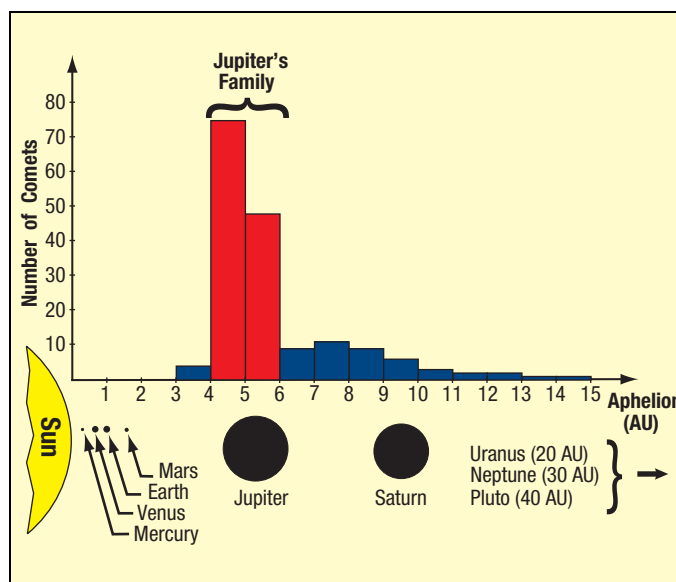

Figure 172: What Is Jupiter’s Family? About 60% of all short-period comets have aphelions 4–6 AU from the Sun. (A comet’s aphelion is its farthest point from the Sun.) Because Jupiter travels in a nearly circular orbit that lies near the center of that range (5.2 AU from the Sun), those comets are called *Jupiter’s family*. (Comets in Jupiter’s family do not travel with Jupiter; those comets and Jupiter have only one orbital characteristic in common—aphelion distance.) Is Saturn, which lies 9.5 AU from the Sun, collecting a family? See the “aphelion scale” directly above each planet.

Why should comets cluster into families defined by aphelions? Why is Jupiter’s family so large? No doubt, Jupiter’s enormous mass has something to do with it. Notice how large Jupiter is compared to other planets and how far each is from the Sun. (In this figure, diameters of the Sun and planets are magnified relative to the aphelion scale.)

processes, or (3) the family had many more comets prior to about 12,000 years ago—perhaps thousands of times as many. Options (2) and (3) present a terrible collection problem. In other words, too many comets cluster in Jupiter’s family, precisely where few should gather or survive for much longer than about 12,000 years. Why?

Long-Period Comets. Of the 298 comets with periods exceeding 700 years, about half (53%) are prograde, while the rest (47%) are *retrograde*, orbiting the Sun “backwards”—in a direction opposite that of the Earth. Because no planets have retrograde orbits, we must ask why so many long-period comets are retrograde, while few short-period comets are.

Intermediate-Period Comets. Only 104 comets have orbital periods between 100 and 700 years. So, we have two completely different populations of comets—short-period and long-period—plus a few in between.

Energy. A comet falling in its orbit toward the Sun exchanges “height above” the Sun for additional speed—just as a ball dropped from a tall building loses elevation but gains speed. Moving away from the Sun, the exchange reverses. A comet’s energy has two parts: **potential energy**, which increases with the comet’s distance from the Sun, and **kinetic energy**, which increases with speed. Kinetic energy is converted to potential energy as the comet moves away from the Sun. The beauty of these exchanges is that the sum of the two energies never changes if the comet is influenced only by the Sun; the total **energy is conserved** (preserved).

However, if a comet orbiting the Sun passes near a planet, energy is transferred between them. What one gains, the other loses; the energy of the comet-planet pair is conserved. A comet falling in the general direction of a planet gains speed, and therefore, energy; moving away from a planet, it loses speed and energy. We say that the planet’s gravity **perturbs** (or alters) the comet’s orbit. If the comet gains energy, the long axis of its elliptical orbit lengthens. The closer the encounter and more massive the planet, the greater the energy exchange. Jupiter, the largest planet, is 318 times more massive than Earth and causes most large perturbations. In about half of these planetary encounters, comets gain energy, and in half they lose energy.

If a comet gains enough energy (and therefore speed), it will escape the solar system. Although the Sun’s gravity pulls on the comet as it moves away from the Sun, that pull may decrease so fast with distance that the comet escapes forever. The resulting orbit is not an ellipse (a closed orbit), but a **hyperbola** (an open orbit). [See Figure 171.] The precise dividing line between ellipses and hyperbolas is an orbit called a **parabola**. Most long-period comets travel on long, narrow ellipses that are almost parabolas. They are called **near-parabolic comets**. If they had slightly more velocity, they would permanently escape the solar system on hyperbolic orbits.

Separate Populations. Few comets with short periods will ever change into near-parabolic comets, because the large boost in energy needed is apt to “throw” a comet across the parabola boundary, expelling it permanently from the solar system. The energy boost would have to “snuggle” a comet up next to the parabola boundary without crossing it.²⁵ Also,

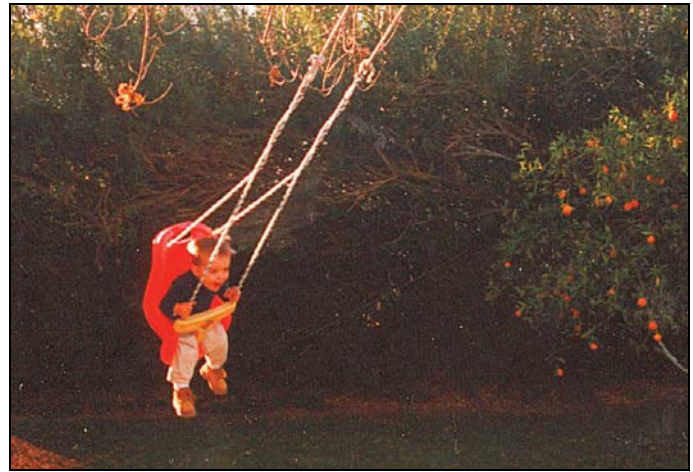

Figure 173: An Early Lesson in Conservation of Energy. At the top of his swing, my grandson, Preston, has a minimum of kinetic energy (energy of motion) but a maximum of potential energy (energy of height). As he approaches the bottom of his swing, where he moves the fastest, he gains kinetic energy but loses an equal amount of potential energy. In between, he has some of both.

Eventually, friction converts both forms of energy into heat energy, slowing the swing, and making Preston unhappy. Comets also steadily exchange kinetic and potential energy, but, in the vacuum of space, do so with essentially no frictional loss.

few long-period comets will become short-period comets, because comets risk getting killed with each near pass of a planet or trip around the Sun. This would be especially true if such dangerous activity went on for millions of years in the “heavy traffic” of the inner solar system.

While all planets travel near Earth’s orbital plane (the ecliptic), long-period and intermediate-period comets have orbital planes inclined at all angles. However, short-period comets usually travel near the ecliptic. Comet inclinations change only slightly with most planet encounters.²⁶ Because few short-period comets can become long-period comets, and vice versa, most must have begun in their current category.

Comet Composition

Light Analysis. Light from a comet can identify some of the dust and gases in its head and tail. Each type of molecule, or portion thereof, absorbs and emits specific colors of light. When this light passes through a prism or other instrument, its spectrum (looking like a long stretched-out bar code) identifies the gases the light passed through. Even light frequencies humans cannot see can be analyzed in the tiniest detail. Some components, like sodium, are easy to identify, but others, such as chlorine, are difficult, because their light is dim or masked by other radiations.

Curved tails in comets have the same specific colors as the Sun; therefore, those tails must contain solid particles (dust) which are reflecting sunlight. Also detected in comets

Figure 174 : Comet Energy.

The tall red bar represents 465 comets²⁷ with extremely high energy—comets that traveled far from the Sun, such as 1,000 AU, 10,000 AU, or 100,000 AU. These comets, traveling on long, narrow ellipses that are almost parabolas, are called *near-parabolic comets*. In 1950, Jan Hendrik Oort mistakenly thought the comets represented by the tall red bar marked the distance from the Sun where **all comets originate**—somewhere between 1,000–100,000 AU. Because they

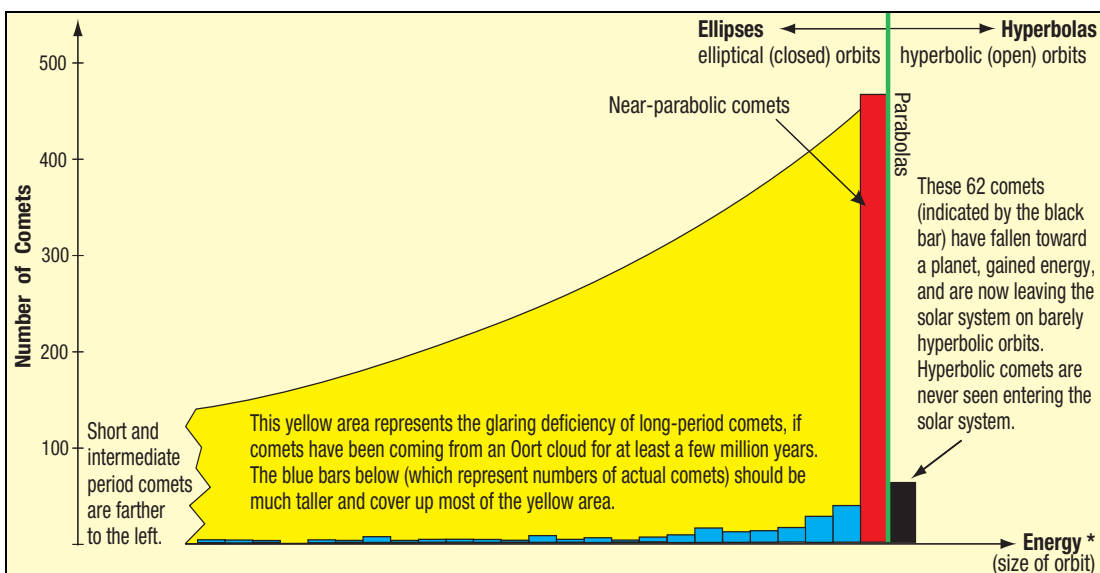

are falling toward the Sun from all directions, he said they are coming from a spherical shell surrounding the solar system. Those who believe Oort, usually substitute 50,000 AU for this broad 1,000–100,000 AU (nearly infinite) range and say that all comets are coming from an imaginary region called the “Oort cloud.” Actually, near-parabolic comets that we now see falling back have similar energies, because the dense concentration of material that gravitationally merged to become comets was launched by the fountains of the great deep at the same time and place—from the Earth at the beginning of the global flood. Their energies are also similar because each particle in the fountains received similar amounts of specific energy (energy per unit mass) for the same reason water droplets shot from a fire hose have similar kinetic energy.

The comets represented by the red bar appear to falling from so far away, because the accelerating effect of the Kuiper Belt²⁸ was naturally unknown before the Kuiper Belt was discovered. Therefore, it appeared that the comets gained their speed by falling toward the Sun from farther out than was truly the case.

No one has detected the Oort cloud with a telescope or any other sensing device.²⁹ *Mathematical errors led to Oort's belief that a cloud of cometary material, called the Oort cloud, surrounds the solar system.*³⁰

Comets orbiting the Sun gain or lose energy by interacting gravitationally with planets. The green line represents parabolic orbits, the boundary separating elliptical orbits from hyperbolic orbits (closed orbits from open orbits). If a comet gains enough energy to nudge it to the right of the green line, it will be expelled from the solar system forever. This happened with the few *outgoing* hyperbolic comets represented by the short, black bar. *Incoming hyperbolic comets have never been seen*³¹—a very important point. About half of all comets will lose energy with each orbit, so their orbits shorten, making collisions with the planets or the Sun more likely and vaporization from the Sun's heat more rapid. So, with each shift to the left (loss of energy), a comet's chance of survival drops. Few long-period comets could survive the many gravity perturbations needed to make them short-period comets.³² If planetary perturbations acted on a steady supply of near-parabolic comets for millions of years, the number of comets in each interval should correspond to the shape of the yellow area.³³ The small number of actual comets in that area (shown by the blue bars) indicates how few near-parabolic comets have made multiple trips into the inner solar system. Figure 174 shows that *near-parabolic comets have not been orbiting the Sun for millions of years*, and there is no Oort cloud.

If the 465 near-parabolic comets represented by the tall red bar had made earlier orbits, their many gravitational interactions with planets would have randomly added or subtracted considerable energy, flattening and spreading out the red bar. Therefore, *those near-parabolic comets were falling back for the first time*,³⁴ and the material from which they formed must have been launched in a burst from near the center of the solar system.

* The horizontal axis represents $1/a$, a proxy for energy per unit mass. The term “ a ” is a comet's semimajor axis. Each interval has a width of 10^{-3} (1/AU).

are water, carbon dioxide, argon,³⁵ and many combinations of hydrogen, carbon, oxygen, and nitrogen. Some molecules in comets, such as water and carbon dioxide, have broken apart and recombined to produce many other compounds. Comets contain trace amounts of methane, ethane, and the amino acid glycine (a building block of life on Earth). On Earth, bacteria produce almost all methane, and ethane comes from methane. How could comets originating in space get high concentrations of these compounds?³⁶

Plumes of methane are seen escaping up into Mars' atmosphere from a few locations,³⁷ but sunlight destroys methane in Mars' atmosphere within a few centuries, so

something within Mars must be producing methane.³⁸ Martian volcanoes are not, because Mars has no active or recent volcanoes. Nor do comets *today* deliver methane fast enough to replace what solar radiation is destroying.³⁹

Furthermore, the methane concentration in Mars' atmosphere is seasonally cyclic.⁴⁰ It increases in the Martian summer and decreases in the Martian winter, implying that something living, whose metabolism increases in the summer and decreased in the winter, is producing that methane. This has been observed by the Mars rover, *Curiosity*, for 5 Earth years (3 Martian years) since *Curiosity* landed on Mars in 2012. Does this mean that bacterial life is in Martian

soil?⁴⁰ Most likely. [See “[Is There Life in Outer Space?](#)” on page 531.] Later in this chapter, a surprising explanation will be given. (Also, complex organic molecules that probably came recently from life have been found on Mars.⁴¹)

Dust particles in comets vary in size from pebbles to specks smaller than the eye can detect. How dust could ever form comets in space is a recognized mystery.⁴² Light analysis shows that the atoms in comet dust are arranged in simple, repetitive, *crystalline* patterns, primarily that of olivine,⁴³ the most common of the approximately 2,500 known minerals on Earth. The type of olivine in comet dust appears to be rich in magnesium, *as is the olivine in rocks beneath oceans and in continental crust*. In contrast, interstellar dust does not appear to be crystalline.

Crystalline patterns form because atoms and ions tend to arrange themselves in patterns that minimize their total energy. An atom whose temperature and pressure allow it to move about will eventually find a “comfortable” slot (next to other atoms) that minimizes energy. (This is similar to the motion of marbles rolling around on a table filled with little pits. A marble is most “comfortable” when it settles into one of the pits. The lower the marble settles, the lower its energy, and the more permanent its position.) Minerals in rocks, such as in the mantle or deep in Earth’s crust, have been under enough pressure to develop a crystalline pattern.⁴⁴

Deep Impact Mission. On 4 July 2005, the Deep Impact spacecraft fired an 820-pound “bullet” into comet Tempel 1, revealing as never before the composition of a comet’s surface layers.⁴⁵ The cometary material blasted into space included:

- silicates*, which constitute about 95% of the Earth’s crust and contain considerable oxygen; both are rare in the near vacuum of space
- crystalline silicates* that could not have formed in frigid (about -450°F) outer space unless the temperature reached 1,300°F and then slowly cooled under some pressure
- minerals that apparently form only in *liquid water*,⁴⁶ such as calcium carbonates (limestone) and clays
- organic material of unknown origin
- sodium, which is seldom seen in space
- very fine dirt—like talcum powder—that was “tens of meters deep” on the comet’s surface

Comet Tempel 1 is fluffy and extremely porous. It contains about 60% empty space, and has “the strength of the meringue in lemon meringue pie.”⁴⁷ *“Researchers now estimate that 15% of [comet 67P] is made up of fluffy particles, which are 99.95 empty space.”*⁴⁸

On 4 November 2010, the Deep Impact spacecraft passed by comet Hartley 2 and found that the most abundant gas being expelled was carbon dioxide (CO₂). [To understand this, see “[Why Do Comets have so Much Carbon Dioxide?](#)” Also see Figure 191 on page 348.]

Why Do Comets have so Much Carbon Dioxide?

Carbon dioxide (CO₂), normally a gas, becomes a solid, called dry ice, when its temperature drops below -109°F (-78.5°C.). Most of us have been fascinated watching vapor clouds of CO₂ gas billowing off dry ice when its surface temperature is warmer than -109°F. Comet material not in the direct sunlight is much colder, so almost all cometary CO₂ is dry ice. What little is exposed to direct sunlight, especially near perihelion, quickly vaporizes (sublimates) into the emptiness of space, as we see with clouds of CO₂ gas still billowing off Comet Hartley 2 in Figure 191 on page 348. Obviously, Comet Hartley 2 is young; it cannot be billions of years old. That raises several questions, “Why do comets have volatile dry ice on their surfaces,⁴⁹ and what is the source of all that CO₂?” Gases disperse in the vacuum of outer space; they do not migrate into comets.

We have shown in “[The Origin of Limestone](#)” chapter on pages 259–266 that when limestone precipitated in the subterranean water chamber, CO₂ gas was given off. So for centuries before the flood, more and more CO₂ was dissolved in the subterranean waters that were later launched from Earth by the fountains of the great deep as the flood began. Today, some of that CO₂ is still dissolved in the ice that makes up most of a comet. However, as that ice evaporates when the comet is near perihelion, CO₂ is released into the comet’s atmosphere (its coma). Some CO₂ drifts into the shadows and onto the comet’s nighttime side, where it quickly freezes and settles back onto the comet’s surface as dry ice. Mysteries solved.

Stardust Mission. In July 2004, NASA’s Stardust mission passed within 150 miles of comet Wild 2 (pronounced “Vilt 2”), caught dust particles from its tail, and returned them to Earth in January 2006. The dust was crystalline and contained “abundant organics”¹ (and even the amino acid glycine⁵⁰), water molecules, and many chemical elements common on Earth but, compared to hydrogen and helium, rare in space: magnesium, calcium, aluminum, titanium, and sulfur. Crystalline material—minerals—should not form in the cold weightlessness of outer space.⁵¹



PREDICTION 29: Comet ice that has never melted will contain dissolved CO₂.

In 2011, it was announced that Wild 2 contained the mineral cubanite that forms only in the presence of *scalding hot liquid water*: 122°F–392°F. According to all standard explanations for comets, it is impossible to form liquid water inside a comet.⁵² Besides, liquid water cannot reach those extremely hot temperatures in a comet’s low-pressure environment! Indeed, even cold liquid water inside

comets will instantly flash into steam, leaving a remnant of ice. Something very unique must have happened.

*The discovery [in Comet Wild 2] of minerals requiring [scalding] liquid water for their formation challenges the paradigm of comets as “dirty snowballs” frozen in time.*⁵³

The only explanation for the minerals found by the Deep Impact and Wild 2 missions is that they formed in the extremely hot, high-pressure, subterranean water chamber.

Rosetta Mission. On 12 November 2014, the European Space Agency’s Rosetta spacecraft landed instruments on Comet 67P/Churyumov-Gerasimenko—a comet that is 72%–74% empty space. This was the first successful landing on a comet. Among the many discoveries were sixteen organic compounds, shown in Table 15.⁵⁴

Some will say that these organic compounds were precursors to life on Earth. Neglected is the more likely alternative: these compounds were fragments of organisms living on Earth that were destroyed in some cataclysm. **If you saw a large pile of bricks mixed with steel, tubes, glass, wire, and insulation, would you conclude that a building was evolving or that a building had been destroyed?**

Finding so many complex organic compounds on such a small body in space is unprecedented. On rare occasions an organic compound (a molecule containing carbon atoms in rings or long chains with such elements as hydrogen, oxygen, and nitrogen attached) might be found near a distant star. Comet 67P contained sixteen complex organic compounds! **They, and especially the fifty samples of the amino acid (glycine) that were found, obviously came from life.**

Molecular Oxygen (O₂). Comet 67P’s atmosphere also contained molecular oxygen (O₂)—two oxygen atoms linked together. Scientists were stunned! O₂ should not have been there, because O₂ should not be in space⁵⁵ and it readily breaks apart and reacts with other chemicals to form compounds such as water, carbon dioxide, carbon monoxide. When it reacts with itself, it forms ozone (O₃). No ozone was on 67P. Molecular oxygen is what we breathe on Earth and is relatively rare except on Earth. Earth’s surface waters are saturated with dissolved molecular oxygen.

The amount of O₂ in 67P’s atmosphere was strongly correlated with the amount of water vapor in the comet’s atmosphere; the more water vapor that escaped from inside the comet as it warmed during the comet’s daytime and as it approached the Sun, the more O₂ entered 67P’s atmosphere. Therefore, molecular oxygen was already dissolved in the water ice when the comet formed.

*O₂ was incorporated into the nucleus during the comet’s formation, ... Current Solar System formation models do not predict conditions that would allow this to occur.*⁵⁶

This explains why O₂ did not have a chance to combine with hydrogen, carbon, or 67P’s complex organic compounds

Table 15. Organic Compounds Found on Comet 67P

Name	Formula
Methane	CH ₄
Methanenitrile (hydrogen cyanide)	HCN
Carbon monoxide	CO
Methylamine	CH ₃ NH ₂
Ethanenitrile (acetonitrile)	CH ₃ CN
Isocyanic acid	HNCO
Ethanal (acetaldehyde)	CH ₃ CHO
Methanamide (formamide)	HCONH ₂
Ethylamine	C ₂ H ₅ NH ₂
Isocyanomethane (methyl isocyanate)	CH ₃ NCO
Propanone (acetone)	CH ₃ COCH ₃
Propanal (propionaldehyde)	C ₂ H ₅ CHO
Ethanamide (acetamide)	CH ₃ CONH ₂
2-Hydroxyethanal (glycolaldehyde)	CH ₂ OHCHO
1,2-Ethanediol (ethylene glycol)	CH ₂ (OH)CH ₂ (OH)
Glycine (an amino acid, obviously from life)	C ₂ H ₅ NO ₂

(listed above in Table 15) to form water, carbon dioxide, or carbon monoxide. It also tells us that the ice particles had to merge gently when the comet formed.

*Comet 67P must have been put together gently, [Andre] Bieler says; otherwise the ice-coated grains that make up its bulk would have been heated and the oxygen removed.*⁵⁷

If comets formed billions of years ago, how could that O₂ remain locked up in ice for all that time—through the formation of the solar system and comets, after innumerable impacts (from rocks to photons), and after millions of passes by the Sun? Kathrin Altwegg of the University of Bern, who coauthored this surprising report in the journal *Nature* admitted, “We never thought that oxygen could ‘survive’ for billions of years.”⁵⁸ [Correct. Molecular oxygen could not survive for billions of years in outer space. W.B.]

If comets brought the chemicals for life to Earth, why didn’t the O₂ gobble up those chemicals long before they reached Earth? We all know what O₂ does to dead bodies.

What is “Interstellar Dust”? Is it dust? Is it interstellar? While some of its light characteristics match those of dust, Hoyle and Wickramasinghe have shown that those characteristics have a much better match with dried, frozen bacteria and cellulose—an amazing match.⁵⁹

Dust, cellulose, and bacteria may be in space, but each raises questions. If it is dust, how did dust form in space? “Cosmic abundances of magnesium and silicon [major

constituents of dust] seem inadequate to give interstellar dust.”⁶⁰ A standard explanation is that exploding stars (supernovas) produced dust. However, supernovas radiate the energy of about 10 billion suns, so any expelled dust or nearby rocks would vaporize. If it is cellulose, *the most abundant organic substance on Earth*, how could such a large, complex molecule form in space?⁶¹ Vegetation is one-third cellulose; wood is one-half cellulose. Finally, bacteria are so complex it is absurd to think they formed in space. How could they eat, keep from freezing, or avoid being destroyed by ultraviolet radiation?

Is all “interstellar dust” interstellar? Probably not. Starlight traveling to Earth passes through regions of space that absorb specific wavelengths of light. The regions showing the spectral characteristics of cellulose and bacteria may lie within or near the solar system. Some astronomers mistakenly assume that because much absorption occurs in interstellar space, little occurs in the solar system.

Heavy Hydrogen. Water molecules (H₂O) have two hydrogen atoms and one oxygen atom. A hydrogen atom contains one proton in its nucleus. On Earth, about one out of 6,400 hydrogen nuclei has, besides its proton, a neutron, making that hydrogen twice as heavy as normal hydrogen. It is called **heavy hydrogen**, or *deuterium*.

Surprisingly, in most comets, one out of 3,200 hydrogen atoms is heavy—*twice that in water on Earth*.⁶² Therefore, comets did not deliver most of Earth’s water, as many writers have speculated. In comets, the ratio of heavy hydrogen to normal hydrogen is 20–100 times greater than in interstellar space and the solar system as a whole.⁶³ Evidently, comets came from an isolated reservoir rich in heavy hydrogen. Many efforts by comet experts to deal with this problem are simply unscientific guesswork. No known process will greatly increase or decrease the heavy hydrogen concentration in comets.

Small Comets

Since 1981, Earth satellites have photographed tiny spots thought to be small, house-size comets striking and vaporizing in our upper atmosphere. [See [Figure 34](#) on page 42.] On average, these strikes occur at an astonishing rate of one every three seconds!⁶⁴ Surprisingly, small comets strike Earth’s atmosphere ten times more frequently in early November than in mid-January⁶⁵—too great a variation to explain if the source of small comets is far from Earth’s orbit.

Small comets are controversial. Those who deny their existence argue that the spots are “camera noise,”⁶⁶ but cameras of different designs and different orbits give the same results. In three experiments, rockets 180 miles above the Earth dumped 300–600 pounds of water-ice with dissolved carbon dioxide onto the atmosphere. Ground radar looking up and satellite cameras looking down

recorded the spots. Ground telescopes have also photographed small comets. These comets are hitting Earth’s atmosphere at an astonishing rate that would deliver, in 4.5-billion years, much more water than is on Earth today.

In other words, if the Earth were 4.5-billion years old, and small comets had been entering our atmosphere at this rate since the Earth began, the Earth should have much more water than it now has. Therefore, either the Earth is young or small comets began falling onto Earth recently—or both.

Details Requiring an Explanation

Summarized below are the hard-to-explain details which any satisfactory theory for the origin of comets should explain.

Formation Mechanism. Experimentally verified explanations are needed for how comets formed and acquired water, dust particles of various sizes, and many chemicals.

Ice on Moon and Mercury. Large amounts of water-ice are in permanently shadowed craters near the poles of the Moon, and planet Mercury.

Crystalline Dust. Comet dust is primarily crystalline.

Near-Parabolic Comets. The observed near-parabolic comets are falling toward the Sun for the first time—and from all directions. Why are so many comets represented by the tall red bar in [Figure 174](#)?

Random Perihelion Directions. Comet perihelions are scattered on all sides of the Sun.

No Incoming Hyperbolic Orbits. Although a few comets leave the solar system on hyperbolic orbits, no obvious incoming hyperbolic comets are known. That is, no comets are known to come from outside the solar system.

Small Perihelions. Perihelions of long-period comets are concentrated near the Sun, in the 1–3 AU range, not randomly scattered over a larger range.

Orbit Directions and Inclinations. About half the long-period comets have retrograde orbits (orbiting in a direction opposite to the planets), but all planets, and almost all short-period comets, are prograde. Short-period comets have orbital planes near Earth’s orbital plane, while long-period comets have orbital planes inclined at all angles.

Two Separate Populations. Why are long-period comets so different from short-period comets? Even millions of years and many gravitational interactions with planets would rarely change one kind into the other.

Jupiter’s Family. How did Jupiter recently collect its large family of comets, each with a short life expectancy of only about 12,000 years?²⁴ [See [Figure 172](#) on page 305.]

Figure 175: Near and Far Sides of the Moon. Today, as the Moon orbits around Earth, the same side of the Moon always faces Earth. Surprisingly, the near and far sides of the Moon are quite different. Almost all deep moonquakes are on the near side.⁶⁷ The surface of the far side is rougher and has more craters, but the near side has most of the Moon's volcanic features, lava flows, dome complexes, and giant, multiringed basins. Also, lava flows (darker regions) have smoothed over many craters on the near side.⁶⁸

Some have proposed that the Moon's crust must be thinner on the near side, so lava can squirt out more easily on the near side than the far side. However, measurements of gravity,⁶⁹ heat flow, and seismic activity destroy that idea. The Moon's density throughout is almost as uniform as that of a billiard ball.⁷⁰ Not only did large impacts form the giant basins, but their impact energy melted rock below, generated lava flows, and *expanded the Moon's radius by 0.6–4.9 kilometers!* The GRAIL satellites detected the cracks that brought the lava to the surface—apparently rapidly and recently.⁷¹ [See **“Hot Moon”** on page 42.]

Large impacts would also shift rock within the moon and produce deep frictional melting. Magma produced below the Moon's crossover depth would sink to the Moon's center and form the Moon's small liquid core that was discovered in 2011.⁷² That core has not had time to cool and solidify. [The crossover depth is explained on pages 156–157.]

Contemporaries of Galileo misnamed these dark lava flows “*maria*” (MAHR-ee-uh), Latin for “seas,” because they filled low-lying regions and looked smooth. These *maria* give the Moon its “man-in-the-moon” appearance. Of the Moon's 31 giant basins, only 11 are on the far side.⁷³ (See if you can flip 31 coins and get 11 or fewer tails. Not too likely. It happens only about 7% of the time.) Why should the near side have so many more giant impact features and almost all the *maria*⁷⁴ and deep moonquakes? Opposite sides of Mars and Mercury are also different.⁷⁵

If the impacts that produced these volcanic features came rapidly from a single direction, only one side would be primarily hit. If the impacts occurred rapidly from all directions or slowly—longer than one orbital period (30 days for the Moon)—from a single direction, all sides would be equally hit. Therefore, large lunar impactors were apparently launched rapidly from Earth. Similar statements can be made for Mars and Mercury, so this bombardment event affected the solar system.

Large impacts would kick up millions of smaller rocks that would create secondary impacts. Some rocks would escape the Moon and possibly hit Earth. Today, both sides of the Moon are saturated with smaller, secondary craters, so Earth's flood cataclysm also beat up the Moon.

This is further confirmed by historical records and orbital calculations. Many ancient cultures worldwide had a 360-day year and a 30.00-day lunar month—or “moonth.” Presumably the word “month” was a carryover from pre-flood times. This would have given all humans on Earth—from creation until the flood—a marvelous calendar system. Regardless of where people lived, they could easily and simply tell time without an expensive, mechanical clock.

If only 1.22% of the debris launched from Earth by the fountains of the great deep hit the Moon, the lunar month would have changed from 30.00 days to its present 29.53-day lunar month, and the Moon's circular orbit would have become the elliptical shape we see today (eccentricity of 0.0549). Other key parameters for the Moon's orbit would also change to what we see today. This bombardment during the flood would explain all the Moon's craters and the details listed above. [See **“Did the Preflood Earth Have a 30-Day Lunar Month?”** by R. Brown on page 586.]

Lunar *rocks* have relatively few volatile elements: water, nitrogen, hydrogen, chlorine, sulfur, and the noble gases. However, lunar *soil* contains these elements—and lots of water!⁷⁶ The isotope ratios of these elements in lunar soil correspond not to the solar wind but to what is found on Earth⁷⁷—suggesting again that they came from Earth. Also, the rocks astronauts brought back from the Moon have identical oxygen and titanium isotopic ratios as those on Earth.⁷⁸ If large impactors came from Earth, most moonquakes should be on the near side. They are.⁶⁷ If these impacts were recent, they might still be occurring. They are.

High Loss Rates of Comets. Comets are being destroyed, diminished, or expelled from the solar system at high rates that are difficult for some theories to explain.

Composition. Comets are primarily water, silicate dust (such as olivine), carbon dioxide, sodium,⁷⁹ and combinations of hydrogen, carbon, oxygen, and nitrogen. Comets also contain limestone, clays, methane, and the amino acid glycine that is almost exclusively produced by life on Earth. Surprisingly, one compound in comets, cubanite, is produced only in *scalding hot liquid* water. Comet 67P has molecular oxygen (O₂) dissolved in its ice.

Heavy Hydrogen. The high concentration of heavy hydrogen in most comets means comets did not come from today's known hydrogen sources—in or beyond the solar system.

Small Comets. What can explain the strange characteristics of small comets, including their abundance and nearness to Earth, but not to Mars? Small comets have never been seen impacting Mars, but there have been many sketchy reports of flashes of light on the Moon.⁸⁰

Missing Meteorites. Meteor streams are associated with comets and have similar orbits. Meteorites are concentrated in Earth's topmost sedimentary layers, so they must have fallen recently, after most sediments were deposited.⁸¹ [See **“Shallow Meteorites”** on page 40.] Comets may have arrived recently as well.

Recent Meteor Streams. As comets disintegrate, their dust particles form meteor streams which orbit the Sun. After about 10,000 years, solar radiation should segregate

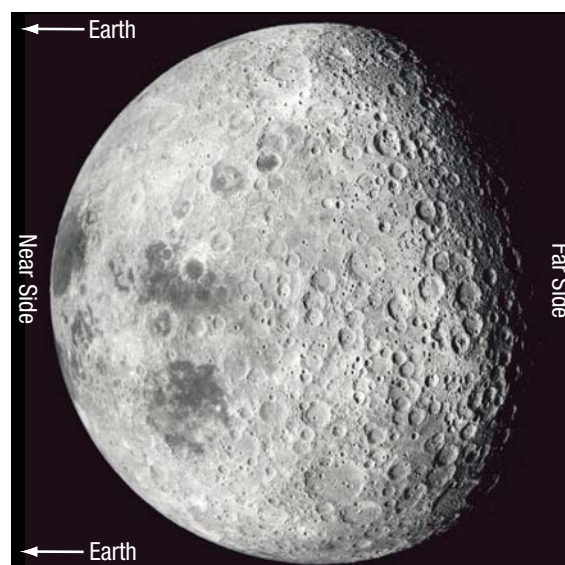

particles by size. Because little segregation has occurred, meteor streams, and therefore comets, must be recent. [See “**Poynting-Robertson Effect**” on page 42.]

Crater Ages. Are the ages of Earth’s impact craters consistent with each comet theory?

Theories Attempting to Explain the Origin of Comets

Seven modern theories have been proposed to explain the origin of comets. Each theory will be described as an advocate would. Later, we will test each theory with the characteristics of comets, listed above, that require an explanation.

Hydroplate Theory. Comets are literally out of this world. As the flood began, the extreme pressure in the interconnected subterranean chambers and the power of supercritical water exploding into the vacuum of space launched material that later merged to become about 50,000 comets, containing less than 1% of the water in the chambers. (These estimates will be derived later.) The chapter on “**The Origin of Earth’s Radioactivity**,” beginning on page 379, will explain the source of most of this launch energy and the great abundance of heavy hydrogen in comets.

As subterranean water escaped, the chambers’ pillars were crushed. Also, the 60-mile-high walls along the rupture were unstable, because granitic rock is not strong enough to support a cliff greater than 5 miles high.⁸² The bottom portions of the walls were crushed into large blocks which were swept up and launched by the fountains of the great deep. Carried up with the water were eroded dirt particles, minerals that form only in *scalding-hot, high-pressure, liquid* water, pulverized organic matter (especially cellulose from pre-flood forests), and even bacteria.

As explained in “**Rocket Science**” on pages 581–582, droplets in this muddy mixture froze quickly in outer space. The expanding spheres of influence of the larger rocks captured more and more smaller rocks and ice, which later merged gravitationally to form comets. Five days later, comets and rocks began hitting the Moon and formed large basins. [See pages 586–592.] Those impacts produced lava flows and debris, which then caused secondary impacts. Water vapor condensed in the permanently shadowed, very cold craters near the poles of Mercury and the Moon.

Hyperbolic comets never returned to the solar system. Near-parabolic comets now being detected are returning to the inner solar system for the first time. Comets with slower velocities received most of their orbital velocity from Earth’s orbital motion around the Sun. They are short-period comets with elliptical, prograde orbits lying near the Earth’s orbital plane. Since the flood, many short-period comets have been pulled gravitationally into Jupiter’s family. Small comets are composed of material that escaped Earth with the least velocity. [Pages 111–151 give a more detailed description of the hydroplate theory.]

Exploded Planet Theory.⁸³ Consistent with Bode’s “law,”⁸⁴ a tenth planet once existed 2.8 AU from the Sun, between the orbits of Mars and Jupiter. It exploded about 3,200,000 years ago, spewing out comets and asteroids. Many fragments collided with other planets and moons, explaining why some planets and moons are cratered primarily on one side. The fragments visible today are those that avoided the disturbing influence of planets: those launched on nearly circular orbits (asteroids) and those launched on elongated ellipses (comets). This theory also explains the origin of asteroids and some similarities between comets and asteroids.

Volcanic Eruption Theory.⁸⁵ The large number of short-period comets, as compared with intermediate-period comets, requires their recent formation near the center of the solar system. Volcanic eruptions, probably from the giant planets (Jupiter, Saturn, Uranus, and Neptune) or their moons, periodically launch comets. Jupiter’s large, recently-acquired family suggests that Jupiter was the most recent planet to erupt. The giant planets are huge reservoirs of hydrogen, a major constituent of comets. New eruptions replenish comets that are rapidly lost through collisions with planets or moons, evaporation when passing near the Sun, and ejection from the solar system.

Oort Cloud Theory.⁸⁶ As the solar system formed 4.5-billion years ago, a cloud of about 10^{12} comets also formed approximately 50,000 AU from the Sun⁸⁷—more than a thousand times farther away than Pluto and about one-fifth the distance to the nearest star. Stars passing near the solar system perturbed parts of this Oort cloud, sending randomly oriented comets on trajectories that pass near the Sun. This is why calculations show so many long-period comets falling into the inner solar system from about 50,000 AU away. As a comet enters the planetary region (0–30 AU from the Sun), the gravity of planets, especially Jupiter, either adds energy to or removes energy from the comet. If energy is added, the comet is usually thrown from the solar system on a hyperbolic orbit. If energy is removed, the comet’s orbital period is shortened. With so many comets in the initial cloud (10^{12}), some survived many passes through the inner solar system and are now short-period comets.

Revised Oort Cloud Theory.⁸⁸ As the solar system began 4.5-billion years ago, all comets formed in a comet nursery near or just beyond the outer giant planets. Because these comets were relatively near the Sun, passing stars and the massive galactic clouds (molecular clouds) could not eject them from the solar system. As with planets, these early comets all had prograde orbits near the plane of the ecliptic. Perturbations by the giant planets gave some comets short periods with prograde orbits near the ecliptic plane. Other perturbations ejected other comets out to form and resupply an Oort cloud, 50,000 AU from the Sun. Over millions of years, passing stars have circularized these latter orbits. Then, other passing stars perturbed some Oort

Table 16. Evidence vs. Theories: Origin of Comets

		Theories							
		Formed in Inner Solar System				Formed in Outer Solar System or Beyond			
		From Earth by Fountains of the Great Deep (<i>Hydroplate Theory</i>)	From Exploded Planet between Mars and Jupiter	From Eruptions on the Giant Planets	Original Oort Cloud: Began Far Beyond Solar System	Revised Oort Cloud: Began Near Edge of Solar System	From Meteor Streams	From Interstellar Dust and Gas Clouds	
Evidence to be Explained	Formation Mechanism	● 1	● 13	⊗ 22	⊗ 30	⊗ 46	⊗ 61	⊗ 73	
	Ice on Moon and Mercury	● 1	⊗ 14	⊗ 23	⊗ 31	⊗ 47	⊗ 62	⊗ 74	
	Crystalline Dust	● 2	●	⊗ 22	⊗ 32	⊗ 48	⊗ 63	⊗ 75	
	Near-Parabolic Comets	● 3	●	●	⊗ 33	● 49	●	●	
	Random Perihelion Directions	● 4	●	● 24	⊗ 34	● 50	● 64	⊗ 76	
	No Incoming Hyperbolic Orbits	●	●	●	⊗ 35	⊗ 51	●	●	
	Small Perihelions	●	●	⊗ 25	⊗ 36	⊗ 52	⊗ 65	⊗ 77	
	Orbit Directions and Inclinations	● 5	●	⊗ 24	● 37	●	● 64	⊗ 76	
	Two Separate Populations	● 5	●	●	⊗ 38	⊗ 53	●	●	
	Jupiter's Family	● 6	⊗ 15	●	⊗ 39	⊗ 54	⊗ 66	⊗ 78	
	High Loss Rates of Comets	●	●	● 26	●	⊗ 55	●	●	
	Composition	● 7	● 16	⊗ 27	● 40	● 56	● 67	● 79	
	Heavy Hydrogen	● 7	●	⊗ 27	⊗ 30	⊗ 46	⊗ 68	⊗ 80	
	Small Comets	● 8	● 17	⊗ 28	⊗ 41	⊗ 57	⊗ 69	⊗ 81	
	Missing Meteorites	●	⊗ 18	●	●	●	● 70	● 82	
	Recent Meteor Streams	● 9	● 19	● 29	● 42	● 58	● 71	● 83	
Crater Ages	● 9	⊗ 20	●	● 43	⊗ 59	●	●		
Other	● 10–12	⊗ 21		⊗ 44–45	⊗ 60	⊗ 72			

Key: ● Explained by theory.
 ● Theory has moderate problems with this item.
 ⊗ Theory has serious problems with this item.

Numbers in this table refer to amplifying explanations on pages 314–324.

cloud comets back into the planetary region, as described by the original Oort cloud theory. Therefore, large numbers of near-parabolic comets are still available to fall into the inner solar system from about 50,000 AU away. An unreasonably large number of comets did not have to begin in the Oort cloud 4.5-billion years ago (where, after a few billion years, passing stars, galactic clouds, and the galaxy itself would easily strip them from the cloud). Short-period comets cannot come from the Oort cloud.

Meteor Stream Theory.⁸⁹ When particles orbiting the Sun collide, they exchange some energy and momentum. If the particles are sufficiently absorbent (squishy), their orbits become more similar.⁹⁰ After millions of years, these particles form meteor streams. Water vapor condenses on the particles in the meteor streams as they pass through the cold, outer solar system. Thus, icy comets form continually. This is why so many meteor streams

have cometlike orbits, and why more short-period comets exist than an Oort cloud could provide.

Interstellar Capture Theory.⁹¹ Comets form when the Sun occasionally passes through interstellar gas and dust clouds. As seen from the Sun, gas and dust stream past the Sun. The Sun's gravity deflects and focuses these particles around and behind the Sun. There, they collide with each other, lose velocity, enter orbits around the Sun, and merge into distinct swarms of particles held together by their mutual gravity. These swarms become comets with long and short periods, depending on how far the collisions were from the Sun.

Evaluation of Evidence vs. Theories

Table 16 summarizes how well each modern theory explains the many strange things associated with comets.

Each column corresponds to a theory, and each row represents a detail that requires an explanation. A green circle means that, in my opinion, the column's theory reasonably explains that row's diagnostic detail. Yellow and red circles indicate moderate and serious problems, respectively. Numbers in Table 16 refer to additional information below. Table 16 shows both the details and the broad perspective—"the trees *and* the forest."

Details Relating to the Hydroplate Theory

1. ● **Formation Mechanism**, ● **Ice on Mercury, Mars, and the Moon.** About 38% of a comet's mass is frozen water. Therefore, to understand comet origins, one must ask, "What was the source of a comet's water?" Earth, sometimes called "the water planet," must head the list. (The volume of water on Earth is ten times greater than the volume of all land above sea level.) Other planets, moons, and even interstellar space⁹² only have possible water, or traces of water, which may have been delivered by comets or by water vapor that the fountains of the great deep launched into space.



PREDICTION 30: Soil in "erosion" channels on Mars will contain traces of earthlike soluble compounds, such as salt, from Earth's pre-flood subterranean chambers. Soil far from "erosion" channels will not. (This prediction was first published in April 2001. Salt was first discovered on Mars in March 2004.⁹³)

The Mars Reconnaissance Orbiter has photographed eight examples of smooth horizontal layers of water ice on Mars—some thicker than 100 meters and only 1–2 meters below the planet's surface.⁹⁴ (One layer is 500-feet thick!) To form a thick horizontal layer of water ice, liquid water had to first collect in that geometric shape—in what we today would call a pond. Furthermore, a large amount of water had to have been rapidly deposited on Mars near each pond, because the water would quickly evaporate in Mars' thin atmosphere while the rest of the flowing water rapidly froze. If that water fell to the surface of Mars as snow, a pond would not have formed. However, if a separate comet delivered the water for each of the eight ponds, each impact would have formed a depression for the pond, melted the comet's ice, and kicked up a cloud of dirt which would account for the 1–2 meters of dirt now on top of the ice layers.

How could so many comets have recently hit the Moon, Mars, and Mercury that ice remains today? Ice on Mars, the Moon, and certainly on hot Mercury, should disappear faster than comets deposit it today. The question is answered if the material that formed 50,000 comets was ejected recently from Earth and an "ocean" of water was injected into the inner solar system. On Mars, comet impacts on slopes created brief saltwater flows, which then carved "erosion" channels. [See Figure 195 on page 355.]

To form comets in space, should we start with water as a solid, liquid, or gas?

Gas. In space, gases (such as water vapor) will expand into the vacuum if not gravitationally bound to some large body. Gases by themselves would not contract to form a comet. Besides, the Sun's ultraviolet radiation breaks water vapor into hydrogen (H), oxygen (O), and hydroxyl (OH). Therefore, comets would not normally form from gases.

Solid. Comets might form by combining smaller ice particles, including ice condensed as frost on microscopic dust grains that somehow formed. However, one icy dust grain could not capture another nearby grain unless their speeds and directions were nearly identical and one of the particles had a rapidly expanding sphere of influence or a gaseous envelope. Because ice molecules are loosely bound to each other, collisions among ice particles would fragment, scatter, and vaporize them—not merge them.

Liquid. The fountains of the great deep launched large rocks, dirt, and water. Water droplets in the expanding supercritical water quickly froze. [See "**Rocket Science**" on page 581.] The ice partially evaporated (sublimated) but left dirt behind, encasing the remaining ice. (Recall that the nucleus of Halley's comet was black, and a comet's tail contains dust particles.)

Jetting water escaping from the subterranean chamber eroded dirt and rocks of various sizes. Water vapor then concentrated around the larger rocks escaping from Earth. These "swarms" and their expanding spheres of influence captured nearby particles moving at similar velocities. Comets quickly formed.⁹⁵

Other reasons exist for concluding that water in a gas or solid state cannot form comets.⁹⁶ Water from the fountains of the great deep meets all requirements.

2. ● **Crystalline Dust.** Sediments eroded by high-velocity water escaping from the subterranean chamber would be crystalline, much of it magnesium-rich olivine.

3. ● **Near-Parabolic Comets.** Because the same event launched all cometary material from Earth, comets falling from the farthest distances (near-parabolic comets) are falling back for the first time and with similar energy. They would also have the largest range of aphelions, and that longer range would include the aphelions of more comets.



PREDICTION 31: Some large, near-parabolic comets, as they fall toward the center of the solar system for the first time, will have moons. Tidal effects may strip such moons from their comets as they pass the Sun. (A moon may have been found orbiting incoming comet Hale-Bopp.)⁹⁷

Questions Precede Advances

Scientific advances require recognizing *anomalies*—observations that contradict current understanding and show a need for deeper insight. Unless anomalies are recognized, scientists lose focus, researchers become complacent, and future discoveries are delayed. Although comet experts will acknowledge many anomalies, textbooks seldom mention them, so teachers rarely hear about them. Consequently, students (our next generation of teachers) are deprived of much of the excitement of science. Critical thinking skills are not fully developed.

Some important conclusions about comets involved several scientists and were gradually accepted. However, for simplicity and to show the flow of progress, only one scientist and date are listed in each row below. Current anomalies are italicized. While each major discovery removes some earlier anomalies and false ideas, each discovery raises new questions. Notice how the major questions preceding 1868 have been answered, and the hydroplate theory answers the italicized question remaining since 1868. Pointing out anomalies in science may draw the wrath of some scientists, but it advances knowledge and can increase the interest and excitement of students.

Table 17. Progress and Problems in Understanding Comets

Date	Conclusions and Questions	Scientist	Reference
340 B.C.	Comets are not planets, because comets change appearance quickly and do not travel in the narrow planetary path across the sky.	Aristotle	Lee ⁹⁸
A.D. 63	Many comet characteristics show that they are not stars, planets, fires, or atmospheric phenomena. [Falsified existing theories.]	Seneca	Corcoran ⁹⁹
635	Comet tails generally point away from the Sun. [Implies that comets have some relationship to the Sun.]	Li Chung-feng	Y, 46–47
1577	Comets do not travel inside Earth's atmosphere, but far beyond the Moon and into "the realm of the planets." ¹⁰⁰	Brahe	B, ¹⁰¹ PLB ¹⁰²
1665	Specific comets reappear. [This idea is usually credited, incorrectly, to Edmond Halley. When Robert Hooke made his proposal, Halley was 9 years old.]	Hooke	Pepys, ¹⁰³ SD, 48
1680	Comets do not travel in straight lines. Their paths are [almost] parabolas. [See " The Great Comet of 1680 " on page 319.]	Dörffel	Y, 99; PLB, 70
1687	Because comets are usually seen near the Sun, comets orbit the Sun. Vapor surrounding the nucleus brightens when near the Sun. Comets obey Newton's law of gravity. [Because they obey fixed, natural laws, they do not portend human disasters.]	Newton	Newton ¹⁰⁴
1698	Six numbers, called <i>orbital elements</i> , describe a comet's movement if planetary perturbations and non-gravitational effects can be neglected. Orbital elements help identify returning comets seen earlier.	Halley	W, 37–40
1705	No incoming comets are on obvious hyperbolic orbits. [No known comets come from outside the solar system.]	Halley	PLB, 124
1759	With great computational effort to adjust for planetary perturbations, comet positions can be calculated (with fair accuracy) about a thousand years forward or backward.	Clairaut	W, 43
1805	Comets have low densities and are largely made of water-ice.	Laplace	Whipple ¹⁰⁵
1812	Comets' elongated and widely inclined orbits are best explained by an explosion in the solar system.	Lagrange	Y, 304–305
1819	Comets shine by reflected light, not by their own light.	Arago	PLB, 167
1864	Spectral analyses of a comet's light reveal some of its chemical composition.	Donati	Y, 214; W, 106
1866	Meteor streams are associated with comets.	Schiaparelli	W, 97
1868	<i>Why do comets contain organic molecules? What was the source of the carbon?</i>	Huggins	SD, 146–155
1884	<i>How could so many fragile comets be forced into Jupiter's family—and remain there today?</i>	Proctor	Proctor ¹⁰⁶
1925	<i>How could comets survive for billions of years?</i>	Russell	B, 67
1948	<i>Why are there so many short-period, prograde comets and so many long-period, retrograde comets?</i>	van Woerkom	van Woerkom ³³
1950	Near-parabolic comets fall toward the Sun with large, but remarkably similar, energies.	Oort	Oort ⁸⁶
1973	Comets cannot form far from the Sun.	Öpik	Öpik ¹⁰⁷
1986	About once every 3 seconds, a small comet hits the Earth's upper atmosphere and vaporizes.	Frank	Frank ⁶⁴
1986	<i>Why didn't small comets form more lunar craters and put more water on Earth, Venus, and Mars?</i>	Donahue	Donahue ¹⁰⁸
1998	Comets are unusually rich in heavy hydrogen. <i>Where did comets get it?</i>	Meier	Meier ⁶²

Abbreviations in the right column are B=Bailey et al., PLB=Peter Lancaster-Brown, SD=Sagan and Druyan, W=Whipple (Mystery of Comets), Y=Yeomans. Page numbers usually follow each abbreviation. See endnotes for complete citations.

If near-parabolic comets are falling in from 50,000 AU (as claimed by Oort Cloud theories), they would have orbital periods of about 4-million years. How then could they have been launched during the flood that began only about 5,000 years ago?

Is the 50,000 AU distance correct? Comets more than 12 AU from the Sun are too faint to see. Their aphelions and orbital periods must be calculated from the tiny portions of their orbits seen when they are close to Earth.

In 1992, trans-Neptunian objects (TNOs) were first discovered. An estimated 70,000 TNOs, 60–1500 miles in diameter, are 30–50 AU from the Sun, a region called the *Kuiper Belt*.¹⁰⁹ Near-parabolic comets spend 99% of their time inside or beyond the Kuiper Belt. During that 99% of their lifetime, they receive an additional acceleration toward the Sun by the Kuiper Belt.²⁸ When near-parabolic comets are close enough to Earth to be seen with telescopes, they appear to have gained their extra speed by falling back from much farther out than their true aphelion. (TNOs are explained in more detail in the next chapter.)

Detecting the Hidden Mass That Comets Feel

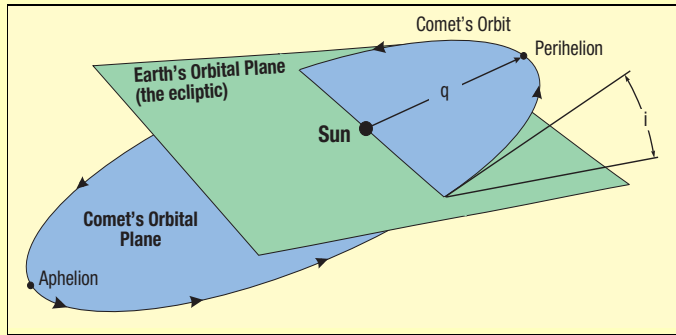

Figure 176: An Orbit's Fingerprint. The path of any body orbiting the Sun closely approximates an ellipse. Each ellipse and its orientation in space are defined by five numbers, two of which are shown above. The first, i , is the angle of inclination—the angle the plane of the ellipse makes with Earth's orbital plane. A second number, q , measures in astronomical units (AU) the distance from the center of the Sun to perihelion. The other three numbers (e , ω , and Ω) need not be defined here but are explained in most books on orbital mechanics or astronautics.

In the last 920 years, over 1,000 different comets have been observed accurately enough to calculate these five numbers. Surprisingly, 12 pairs of comets have very similar sets of numbers. Could some of these “strange pairs” really be the same comet on two successive orbits? The estimated orbital periods for each member of the “strange pair” are so different that they should not be the same comet. [See the far right column in Table 18.] However, if the comets were all different, the chance of any two randomly-selected comets having such similar orbits is about one out of 100,000.¹¹⁰ The chance of getting at least 12 “strange pairs” from the vast number of possible pairings is about one out of 7,000. *If the solar system's mass has been slightly underestimated, orbital periods are much shorter, and some “strange pairs” are almost certainly the same comet.* Other reasons will soon be given for why a slight amount of extra mass exists in the solar system. Where could that mass be?

If the extra mass were uniformly distributed in a spherical shell just outside the solar system, an additional mass of 70 Jupiters would be needed. If the mass were distributed in a uniform torus (a hoop—or a donut shaped region), the

mass of two Jupiters would be needed. Both possibilities are unreasonably large. A more likely explanation is the Kuiper Belt, which was discovered in 1992 and contains about 70,000 trans-Neptunian objects (TNOs) totaling 2-4% of Earth's mass. If a comet, falling in from its aphelion outside the Kuiper Belt, were to pass near one of these 70,000 TNOs, the comet could receive a large gravity boost. When that comet was finally close enough to Earth to be observed, its added speed could make the comet appear to have an orbital period of a few million years. [TNOs are discussed beginning on page 356.]

Each pair of rows in Table 18 describes two sightings of comets with remarkably similar orbits. The far left column tells when, to the nearest tenth of a year, the comet passed perihelion. The next five columns specify the comet's orbit. The comets seen in 1097, 1538, and 1947 may be the same comet.

Table 18. Twelve “Strange Pairs”

Comet (year)	i (°)	q (AU)	e	ω (°)	Ω (°)	Period (year)
1877.7	102.227	1.575904	1.00000	143.2049	252.7106	infinite
1994.8	101.737	1.845402	0.99951	142.7849	249.9436	236,165
1846.4	122.377	1.375992	1.00000	78.7517	163.4642	infinite
1973.4	121.598	1.382019	0.99872	74.8598	164.8177	35,603
1439.4	81.0000	0.120000	1.00000	140.0000	192.0000	infinite
1840.3	79.8512	0.748504	1.00000	138.0440	188.2715	infinite
1863.0	137.541	0.803238	1.00000	230.5764	357.6952	infinite
1978.7	138.264	0.431870	1.00000	240.4503	358.4191	infinite
1304.1	65.0000	0.840000	1.00000	25.0000	88.7000	infinite
1935.2	65.4251	0.811148	0.99130	18.3969	92.4472	901
1770.9	148.555	0.528240	1.00000	260.3750	111.9440	infinite
1980.0	148.601	0.545164	0.98759	257.5849	103.2190	291
1580.9	64.6120	0.602370	1.00000	89.3670	24.9480	infinite
1890.5	63.3509	0.764087	1.00000	85.6608	15.8347	infinite
1337.5	143.600	0.749000	1.00000	79.6100	97.6100	infinite
1968.6	143.238	1.160434	1.00066	88.7151	106.7471	infinite
1742.1	112.948	0.765770	1.00000	328.0430	189.2010	infinite
1907.2	110.057	0.923861	1.00000	328.7561	190.4170	infinite
1097.7	41.0000	0.300000	1.00000	298.0000	352.0000	infinite
1538.0	42.4600	0.147700	1.00000	287.7000	356.2000	infinite
1097.7	41.0000	0.300000	1.00000	298.0000	352.0000	infinite
1947.4	39.3015	0.559799	0.99742	303.7545	353.909	3,209
1680.9	60.678	0.006222	0.99998	350.6128	276.6339	10,000
2013.8	61.952	0.012453	1.0002	345.5312	295.6520	infinite

More Evidence of that Extra Mass. Of the periodic comets (comets observed on at least two passes through the inner solar system), three appeared to have traveled farther from the Sun than all others. All three returned earlier than they should have, assuming that they did not encounter extra mass (such as TNOs) beyond 30 AU that pulled them back early. The Great Comet of 1680 is explained on page 319. Comet Ikeya-Zhang's (ee-KAY-uh ZAING) earliest observed perihelion was on 29 January 1661. Its orbital period, neglecting perturbations by TNOs,

should have been 367 years. However, it returned on 19 March 2002, 26 years early. Comet Herschel-Rigollet's earliest observed perihelion was on 20 November 1788. Its orbital period, based on the accepted mass of the solar system, and neglecting TNOs, should have been 162 years. However, it returned on 9 August 1939, 11 years early.¹¹¹

What if two comet sightings, a century or more apart, were of comets which we assumed had such long periods that they should not be the same comet, but whose orbits were

so similar they probably *were* the same comet? We might suspect that both sightings were of the same comet, and it encountered some extra mass beyond 30 AU (in the Kuiper Belt) that pulled it back much sooner than expected. twelve “strange pairs” are known, suggesting that extra, unseen mass beyond Neptune’s orbit affects long-period comets but is not felt within the planetary region. These “strange pairs” are explained in [Figure 176](#) and [Table 18](#).

4. ● Random Perihelion Directions. Comets were launched in all directions, because the rupture encircled the rotating Earth and crossed almost all latitudes.

5. ● Orbit Directions and Inclinations, ● Two Separate Populations. A ball tossed in any direction from a high-speed train will, to an observer on the ground, initially travel almost horizontally in the train’s direction. Likewise, low-velocity cometary materials launched in any direction from Earth received most of their orbital velocity from Earth’s high, prograde velocity (18.5 miles per second) about the Sun. Earth, by definition, has zero angle of inclination. This is why almost all short-period comets (whose material was launched with low velocity) are prograde and have low angles of inclination.



PREDICTION 32: Up to 70 Jupiters of mass are distributed 30–600 AU from the Sun, enough to give recently observed near-parabolic comets orbital periods of about 5,000 years. (This prediction has not yet been verified. However, with the discovery of so many TNOs, the great mass of many Jupiters is not needed. A close pass of an incoming comet by one or more of the 70,000 TNOs could provide the needed perturbation.)



PREDICTION 33: Because the solar system is slightly “heavier” than previously thought, some comet pairs listed in [Table 18](#) are the same comet seen on successive orbits. More “strange pairs” will be found each decade. [Comet ISON, discovered in 2012, and the Great Comet of 1680 are one example. See “[The Great Comet of 1680](#)” on [page 319](#).]

Cometary materials launched with greater velocities than Earth’s orbital velocity traveled in all directions. Those launched in the prograde direction had an additional 18.5 miles-per-second boost because of Earth’s prograde direction, so some of those launches exceeded 26.3 miles per second, causing them to escape the solar system. Nevertheless, those velocity boosts insured that slightly more long-period comets travel in the prograde direction. [See [Table 14](#) on [page 305](#).] (Almost all other bodies orbiting the Sun are prograde: planets, asteroids, meteoroids, short-period comets, and trans-Neptunian objects.)

While this explains how two populations formed, did the material launched from Earth that later formed comets have enough velocity to blast through the atmosphere, escape Earth’s gravity, and enter large, even retrograde, orbits?

Water pressurized by the weight of 60 miles of rock would launch comets from Earth’s surface at only 3 miles per second. To escape Earth’s gravity and enter a circular orbit around the Sun requires a launch velocity of 7 miles per second. However, to enter a near-parabolic, retrograde orbit, requires a launch velocity of 32 miles per second!

Yes, the fountains of the great deep were powerful enough to reach these speeds. To appreciate the huge, mind-boggling energy in the subterranean water, requires understanding tidal pumping, supercritical water, and the origin of Earth’s radioactivity—explained on [pages 126, 595–596, and 379–433](#). Earth’s atmosphere would offer comparatively little resistance at such speeds. In seconds, the pulsating, jetting fountains would push the thin atmosphere aside, much as water from a fire hose quickly penetrates a thin wall.

6. ● Jupiter’s Family. A bullet fired straight up slows to almost zero velocity near the top of its trajectory—its farthest point from Earth. A comet also moves very slowly near its aphelion. If a comet’s aphelion is ever near Jupiter during any of Jupiter’s orbits, Jupiter’s large gravity will pull the nearly stationary comet steadily toward Jupiter for the long duration the comet is near its aphelion. Even the comet’s orbital plane is slowly but steadily aligned with Jupiter’s. Thus, aphelions of short-period comets tend to be pulled toward Jupiter’s nearly circular orbit, regardless of whether the aphelion is inside, outside, above, or below that circle. The closer a comet’s aphelion is to Jupiter’s orbit, the more rapid the attraction. [See [Figure 177](#).]

One can also think of Jupiter’s mass as being spread out in an imaginary hoop along Jupiter’s circular orbit. (This simplifies the analysis of many long-term gravitational effects.) Comets feel more pull toward the nearest part of the hoop.

My statistical examination of all historical sightings of every orbit (almost 500) of every comet in Jupiter’s family confirms this effect. The hydroplate theory places the source of comets at Earth—well inside Jupiter’s orbit. Therefore, many comets reach their slowest speeds within a few astronomical units of Jupiter’s hoop. Thousands of years of gentle gravitational tugs by this hoop have gathered Jupiter’s family. Although Jupiter sometimes destroys comets or ejects them from the solar system, many comets in its family remain, because they were recently launched. A similar but weaker effect is forming Saturn’s family. [See [Figure 172](#).]

7. ● Composition, ● Heavy Hydrogen. When the fountains of the great deep erupted, rocks were crushed, eroded, and sometimes reduced to clay. Mixed with that debris were minerals that form only in the presence of *scalding hot liquid* water, such as cubanite (described on [page 308](#)).⁵² Also common in comets is sodium, because salt, NaCl, from the subterranean chamber contains sodium. Organic compounds—including methane, ethane, the amino acid glycine, and other complex compounds listed in [Table 15](#) on [page 309](#)—are found in comets,¹ because that

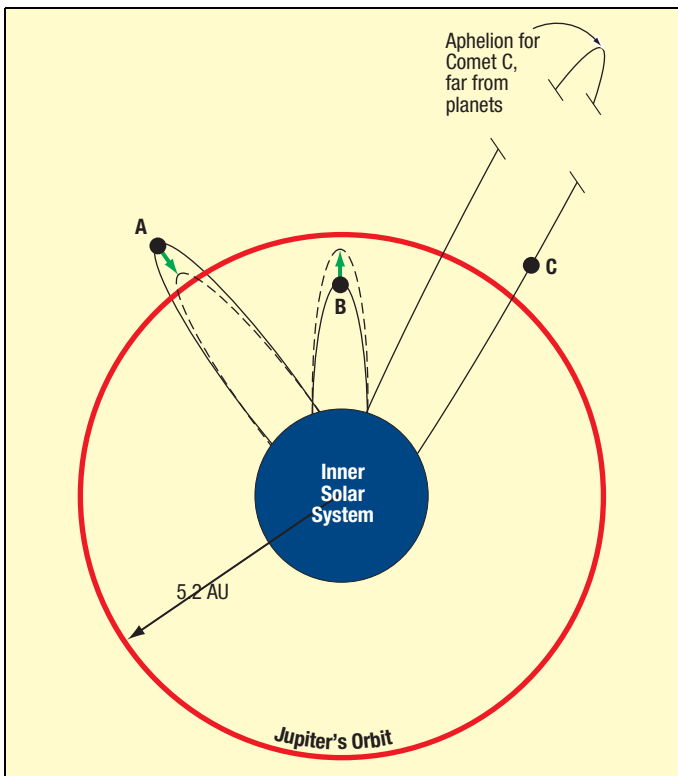

Figure 177: Adoption into Jupiter's Family of Comets. If comets were launched from anywhere in the inner solar system, many, such as comets A and B, would have aphelions within a few astronomical units (AU) of Jupiter's orbit. Comets spend much of their time near aphelion, where they move very slowly. There, they often receive gentle gravitational pulls (green arrows) of long duration, toward Jupiter's orbit, 5.2 AU from the Sun.

Let's say Comet C's came from the supposed Oort Cloud, 50,000 AU from the Sun. (At this figure's scale, Comet C's aphelion would be 1/5 mile from where you are sitting.) Comet C steadily gains speed as it falls toward the inner solar system for thousands of years, crossing Jupiter's orbit at tremendous speed. To slow C down enough to join Jupiter's family would require such powerful forces that the comet would be torn apart, as shown in Figure 170 on page 304. (Comets are fragile.) Could many smaller gravitational encounters pull C into Jupiter's family? Yes, but close encounters are rare, and about half would speed the comet up and probably throw it out of the solar system. Once in Jupiter's family, the average comet has a life expectancy of only **about 12,000 years**.²⁴

Clearly, comets must have originated recently from the inner solar system (the home of the Sun, Mercury, Venus, Earth, and Mars) to join Jupiter's family. Such comets could not have come from far beyond Jupiter's orbit.

water contained pulverized vegetation from pre-flood forests (as well as bacteria and other traces of life) from within a few hundreds miles of the globe-encircling rupture.

Comets are rich in heavy hydrogen, because the water in the subterranean chambers was isolated from other water in the solar system. Our oceans have half the concentration of heavy hydrogen that comets have. So, if half the water in today's oceans came from the subterranean chambers (as assumed on page 124), then almost all heavy hydrogen came from the subterranean chambers. (This will become

even more clear after reading the radioactivity chapter on pages 379–433.) Because molecular oxygen (O_2) is dissolved in and saturates Earth's surface waters, and the water in comets came from Earth, it is not surprising that the ice in Comet 67P contains dissolved O_2 .



PREDICTION 34: Excess heavy hydrogen will be found in salty water pockets five or more miles below the Earth's surface.

Items a–e on page 308 lists six surprising materials discovered on comet Tempel 1 by the Deep Impact mission in 2005. Only the hydroplate theory seems to explain the fluffy, porous texture of comets, and crystalline silicates, clays, calcium carbonates, organic material, sodium, oxygen, and, of course, liquid water. Dust particles brought back to Earth by the Stardust Mission in 2006 were also crystalline and contained “organics” and “water.”

Item f (thick surface layers of very fine dirt with the consistency of talcum powder) is probably *loess*, a type of dirt composed of fine particles in the muddy ice that formed comets. Each time Tempel 1 came near the Sun in its 5½-year orbital period, more ice on the comet's surface sublimated, leaving behind the embedded powdery dirt. Loess is described in more detail on pages 275 and 282.



PREDICTION 35: Spacecraft landing on a comet's nucleus will find that comets, and bodies hit by comets, such as Mars, contain loess, salt, bacteria, and traces of vegetation.

8. ● Small Comets. Muddy droplets launched with the slowest velocities could not move far from Earth, so their smaller spheres of influence produced small comets. Their orbits about the Sun tend to intersect Earth's orbit more in early November than mid-January. Because small comets have been falling on Earth for only about 5,000 years, little of our oceans' water came from them—or from any comets. Few small comets can reach Mars.

9. ● Recent Meteor Streams, ● Crater Ages. Disintegrating comets produce meteor streams. If meteor streams were older than 10,000 years, the particles in them would be sorted by size. [See “**Poynting-Robertson Effect**” on page 42.] Because this is not seen, meteor streams and comets must be younger than 10,000 years. Only the hydroplate theory claims that comets began this recently. Impact craters on Earth are also young.

10. ● Other/Enough Water. Did the subterranean chamber have enough water to produce all the comets the solar system ever had?

Consider these facts. Earth's oceans contain 1.43×10^9 cubic kilometers of water. If comet Tempel 1 (the most accurately measured comet as of 2015) is typical of all

The Great Comet of 1680

One of the most famous comets of all time, the first comet discovered by telescope, is the Great Comet of 1680.¹¹² It became visible during the day, and at night its tail spanned 70 degrees. Most importantly, it played a key role in helping Isaac Newton develop his law of gravitation—a monumental scientific advancement. The comet owed its brightness to its fiery passage only 0.006 AU from the center of the Sun, followed by a close pass by Earth. Astronomers claimed that Comet 1680, a nearly parabolic comet, would travel 889 AU from the Sun and return to the inner solar system in 10,000 years.

Why then, did another comet, discovered in September 2012 and tentatively named Comet ISON (International Scientific Observation Network), appear to be on an almost identical path as Comet 1680? ISON passed so close (0.012 AU) to the Sun's center on 28 November 2013 that ISON was destroyed. (Except for a special class of comets, called Kreutz Sungrazers, less than 1% of the known comets have passed that close to the Sun.) These similarities seem too rare to be coincidences. *Did Comet 1680 return early?* For two months after this discovery, many astronomers said the orbits of ISON and Comet 1680 are so similar that they must have split apart many revolutions earlier and then traveled in tandem—but 333 years apart!

Even stranger, ISON was on a hyperbolic orbit; that is, *if no perturbations by TNOs occurred*, then ISON was falling toward the Sun so fast it must have originated far outside the solar system. That would mean ISON and Comet 1680 did not split apart while inside the solar system. However, I have said that a true incoming hyperbolic comet will never be seen, because all comets



Figure 178: The Great Comet of 1680. This painting shows the scene at sunset in Rotterdam, the Netherlands, on 10 December 1680.

formed in the inner solar system soon after the flood began. Am I wrong, or did these experts ignore TNO perturbations?

Is there a way to resolve ISON's two paradoxes: (1) its remarkable orbital similarities with the Great Comet of 1680, and (2) its supposed hyperbolic orbit? A hyperbolic orbit is especially surprising, because it would be quite rare for a comet from outside our solar system to pass so close to the Sun—almost like barely missing a bull's-eye from a distant star's solar system light-years away.

Pages 316–317 explain why gravity perturbations by some of the 70,000 TNOs would make Comet ISON appear to be on a hyperbolic orbit when, in fact, it was the Great Comet of

comets, then a comet nucleus is about 38% water by mass and has a density of about 0.62 gram per cubic centimeter.⁵ Over 1,000 comets have been observed with enough detail to calculate their elliptical orbits. If 50,000 comets were initially launched (many of which escaped the solar system or were later destroyed) and their average radius was 4.9 kilometers,¹¹³ then they contained about 1/250th of the water now in the oceans.

$$\frac{50,000 \left(\frac{4}{3}\right) \pi (4.9 \text{ km})^3 \left(0.62 \frac{\text{gm}}{\text{cm}^3}\right) (0.38)}{1.43 \times 10^9 \text{ km}^3 \left(1.00 \frac{\text{gm}}{\text{cm}^3}\right)} = 0.004 = \frac{1}{250}$$

With such a small fraction of Earth's water required, the water in comets could have easily come from Earth.

11. ● Other/Death and Disaster. Comets, launched at the onset of the flood, are being steadily removed from the solar system. For centuries after the flood, comets would have been seen much more frequently than today. Some

must have collided with Earth, just as Shoemaker-Levy 9 collided with Jupiter in 1994. People living soon after the flood would have seen many comets grow in size and brightness in the night sky over several weeks. Some of those frightening sights would have been followed by impacts on Earth, skies darkened with water vapor dumped by comets, and dramatic stories of destruction. Memories of these experiences spread worldwide. Early cultures probably learned from their ancestors that comets and their destruction were seen right after the flood, so comets became associated with death and disaster worldwide—hence the word “disaster”: *dis* (evil) + *aster* (star).

12. ● Other/Near Side of Moon. Moonquakes, lava flows, and large multiringed basins are concentrated on the side of the Moon that now always faces the Earth. [See Figure 175 on page 311 and Figure 179.] Before the flood, the Moon was relatively smooth, and it is likely that one side did not always face the Earth. Approximately 5 days after the fountains of the great deep erupted, about 1.2% of the

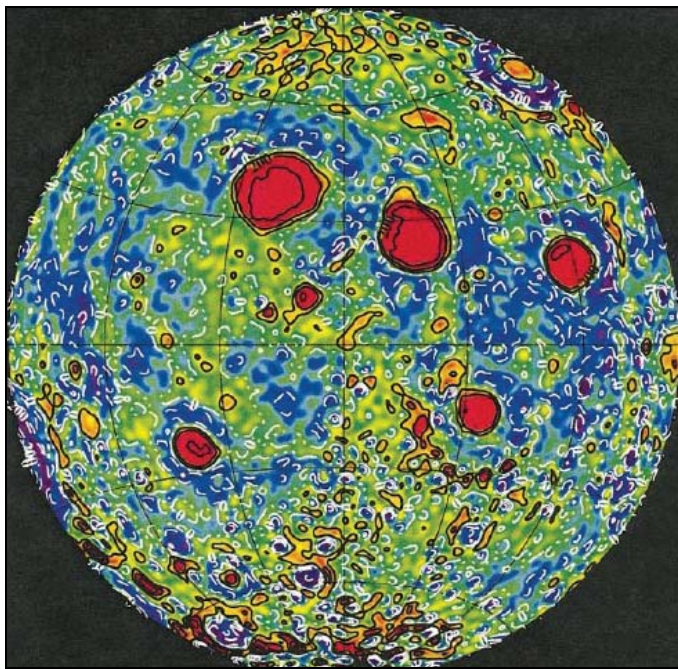

Figure 179: Mascons. Five prominent and dense concentrations of mass are on the side of the Moon that today always faces the Earth. (None on the Moon's far side is comparable.) This map shows how the Moon's gravity varies over its surface. Red indicates unusually strong gravity. Obviously, the Moon received five extremely powerful impacts. Rarely would five impacts be so close to each other unless the impactors were traveling on similar paths and struck the Moon about the same time.

Notice that the three largest mascons, each associated with a basin, lie on a straight line. When a large body's gravity pulls a comet apart, as shown by the "string of pearls" in Figure 170 on page 304, the comet fragments are aligned, and they stay aligned if they don't travel far. Perhaps the large rocks that formed the mascons were part of the same comet (or asteroid) that was pulled apart by the Moon's or Earth's gravity.

rocky debris impacted the Moon in a small area somewhere on the leading side of the Moon. This changed the Moon's inertia and caused the Moon to oscillate like a decaying pendulum swinging above the Earth. Eventually, tidal stretching of the Moon removed most of its spin energy, so the oscillations subsided and the Moon became gravitationally stabilized where the denser, heavier side of the Moon now always faces Earth. (Five large, dense mass concentrations, called *mascons*, were discovered in 1968 just below the surface on today's near side of the Moon.¹¹⁴)

The Moon has been heavily bombarded. If these impacts removed only 6% of the Moon's orbital energy, the Moon's prelood orbital period would have been 30 days, as viewed from Earth. If the length of a month was exactly 30 days and the Moon was in a circular orbit before the flood, only 1.2% of the debris would need to impact the Moon to give it the current 29.53-day month and 0.055 eccentricity (slightly elliptical shape orbit). A 30-day period, coupled with the prelood 360-day year (as explained on page 159 and Endnote 35 on page 185), would have provided

excellent clocks for everyone on Earth—simple, free, visible to all, and standardized worldwide. [See "Did the Preflood Earth Have a 30-Day Lunar Month?" on page 586.]

Note: From here to page 324, the reader may wish to examine only discussions concerning theories of personal interest.

Details Relating to the Exploded Planet Theory

13. ● Formation Mechanism. Explosions produce a wide range of fragment sizes. Rock fragments from an exploded planet would vary from the size of dust up to maybe a quarter of the planet itself. The rocks seen in comets and on asteroids are much more uniform in size. Also, comet dust is mixed uniformly within comet ice. How would a planet, before exploding, have dust mixed within its water?

14. ✖ Ice on Moon and Mercury. It is highly unlikely that trillions of tons of ice from a distant explosion 3,200,000 years ago would still survive and be found in craters on the Moon and Mercury.

15. ✖ Jupiter's Family. If comets suddenly formed 3,200,000 years ago, why would the comets in Jupiter's family now have life spans of only about 12,000 years?

16. ● Composition. If comets formed as this theory claims, why would they have organic matter, including minerals that form only in *hot scalding liquid water*?⁵² Vegetation and bacteria could not originate in the cold, dim asteroid belt, so far (2.8 AU) from the Sun. This theory does not explain any of the material found and chemically analysed on the only three comets visited by spacecraft. [See the Stardust, Deep Impact, and Rosetta missions discussed on page 308.]

17. ● Small Comets. Comets originating 2.8 AU or farther from the Sun 3,200,000 years ago would not concentrate small comets at Earth's orbit today. Certainly, they would not tend to strike Earth ten times more frequently in early November than in mid-January.

18. ✖ Missing Meteorites. If comets are as old as this theory claims, many more iron meteorites should have been found deeper below the Earth's surface.

19. ● Recent Meteor Streams. See item 9 above.

20. ✖ Crater Ages. If a planet exploded 3,200,000 years ago, many craters on Earth should have corresponding ages. Even if one accepts evolutionary dating techniques, craters do not cluster at that age, or at any age.¹¹⁵

21. ✖ Other/Scattering. The total mass of all asteroids is only about 0.044% (about 1/2,300) of Earth's mass. Combining all asteroids would hardly produce a planet.

Exploding and dispersing a typical planet requires enormous energy.¹¹⁶ Even if a planet composed of pure TNT suddenly exploded, it would collapse back upon itself because of the large, mutual gravitational attraction of all its pieces. Napier and Dodd have shown that no known chemical, gravitational, or plausible nuclear source of energy appears capable of exploding and scattering an entire planet in the solar system.¹¹⁷ A head-on collision between two planets at 2.8 AU could provide the needed energy but would not evenly disperse comet-size chunks or give them the energy distribution shown in Figure 174 on page 307.

Details Relating to the Volcanic Eruption Theory

22. ✖ Formation Mechanism, ✖ Crystalline Dust. The giant planets, primarily big balls of frigid gas, have little dust and are too cold to have powerful volcanoes.

23. ✖ Ice on Moon and Mercury. Same as item 14.

24. ☉ Random Perihelion Directions, ✖ Orbit Directions and Inclinations. A few, brief, volcanic eruptions from planets or moons would launch primarily prograde comets in specific directions with similar orbital planes and perihelion directions. Instead, about half the long-period comets are retrograde and have randomly oriented orbital planes and perihelions.

The most violent volcanic eruption seen anywhere in the solar system occurred not on Earth, but on Io (EYE-oh), a moon of Jupiter. The energy released was less than a thousandth of that needed to launch even a few comets from Io. Besides, Io was expelling sulfur dioxide, not water.¹¹⁸ Volcanic eruptions would lose too much energy in passing up through narrow conduits and vents. High pressures can only build up in a solid—not in a gaseous planet.

25. ✖ Small Perihelions. Long-period comets have perihelions concentrated in the 1–3 AU range. Had they been launched from a giant planet (those lying 5–30 AU from the Sun), their perihelions would be farther from the Sun.

26. ☉ High Loss Rates of Comets. Vsekhsvyatsky, this theory's leading advocate, by assuming billions of years of comet accumulation, estimated that at least 10^{20} grams of comets are expelled from the solar system each year.¹¹⁹ Other cometary material should have been lost by evaporation and collisions. On Earth, all volcanoes combined eject only about 3×10^{15} grams of material into the atmosphere each year.¹²⁰ Therefore, according to this theory, cometary material is being lost from the solar system thousands of times faster than Earth's volcanoes are ejecting material only a few miles above Earth's surface.

Matter expelled from a planet or moon might later collect gravitationally into a comet if a large amount of it traveled together. However, volcanoes eject small amounts of matter over wide angles. Ejected material must also travel far

enough from the planet to have a large sphere of influence. For the giant planets, this is difficult. Jupiter's escape velocity, for example, is 38 miles per second. Astronomers have never seen matter being permanently expelled from a giant planet.

27. ✖ Composition, ✖ Heavy Hydrogen. The giant planets are primarily gas—hydrogen and helium. Those planets do not have the higher concentrations of the heavier elements that are in comets. The ratio of heavy hydrogen to normal hydrogen in comets is 20 times greater than in Jupiter and Saturn. If oxygen, carbon, silicon, magnesium, nitrogen, sodium, and other relatively heavy elements in comets came from any giant planets, they must have come from deep within, where they would sink. Eruptions from deep within gaseous planets would be easily suppressed by viscous drag. If comets came from any giant planets or their barren moons, why would comets have organic compounds, such as methane, ethane, and the amino acid glycine or minerals that form only in the presence of *hot liquid* water? This theory does not explain any of the six discoveries of the Deep Impact mission listed on page 308.

28. ✖ Small Comets. See item 17.

29. ☉ Recent Meteor Streams. See item 9 on page 318.

Details Relating to the Original Oort Cloud Theory

30. ✖ Formation Mechanism, ✖ Heavy Hydrogen. According to this theory, comets, as well as the rest of the solar system, began as a cloud of dust and gas (including water vapor) orbiting the Sun. If so, the ratio of heavy hydrogen to normal hydrogen in comets should be typical of the rest of the solar system; instead, it is 20 times greater.

Supposedly, solar radiation never broke apart (or *dissociated*) the water vapor, because it was shielded by dust particles. Water vapor could then condense as frost on the dust. However, in a virtual vacuum, dust particles coated with ice would have tiny, fixed spheres of influence, so they would not capture each other to form larger clusters—let alone comets—even over billions of years. Instead, rare collisions would scatter particles held together by their weak mutual gravity. No experimental evidence has shown how, in the vacuum of space and in less than several billion years, billions of tons of particles can merge into even one comet—much less 10^{12} comets. (A similar problem exists for planets.) Also unexplained is how interstellar dust formed.

31. ✖ Ice on Moon and Mercury. Same as item 14.

32. ✖ Crystalline Dust. Dust that formed in outer space should be noncrystalline. Comet dust is crystalline, so it did not form in outer space as this theory assumes.

33. ✖ Near-Parabolic Comets. If comets have been falling in from an Oort cloud for only a few million years, let alone since the solar system supposedly evolved 4.5-billion years ago, many long-period comets should be

coming in for the second, third ... or one hundredth time. There is a recognized lack of such comets. Almost all are falling in for the first time. [See [Figure 174](#) on page 307.]

Some believe we do not see second-pass comets because the Oort cloud was perturbed recently. This overlooks the presence of many comets in Jupiter's family and the absence of a perturbing star. [See [Item 44](#) below.]

34. ☒ *Random Perihelion Directions.* If a passing star did stir up the Oort cloud, causing many comets to fall toward the Sun, comet perihelions should cluster on one side of the Sun. Actually, comet perihelions lie on all sides.¹²¹

35. ☒ *No Incoming Hyperbolic Orbits.* If passing stars or other gravitational disturbances “shake” comets from an Oort cloud, some of those comets should have obvious hyperbolic orbits as they enter the planetary region. None have been reported, so there is probably no Oort cloud.

Comets that formed around other stars should also be ejected by any passing stars. Such interstellar comets should enter our solar system every year or two—on hyperbolic orbits. Because incoming comets with hyperbolic orbits have never been seen, the formation processes described above probably do not happen. Leading advocates of the Oort cloud theory acknowledge this problem.³¹

36. ☒ *Small Perihelions.* Using the scale in [Figure 177](#) on page 318, visualize comets in an Oort cloud $\frac{1}{5}$ mile from the blue circle representing the inner solar system. Perturbations from a passing star that far away would not be precise and delicate enough to cluster comet perihelions inside the tiny blue circle that, on the same scale, is less than an inch in diameter.

Fernández¹²² and Weissman¹²³ showed, using Oort cloud theories, that perihelions of near-parabolic comets would not cluster in the 1–3 AU range (inside the blue circle), yet they do. Instead, the number of perihelions would increase as their distance from the Sun increases.

37. ☉ *Orbit Directions and Inclinations.* Explaining how planets evolved is difficult enough, but at least they have some common features, such as prograde orbits in planes near the ecliptic—all within 30 AU of the Sun. Also, to evolve comets 50,000 AU from the Sun, moving in randomly oriented planes, and with some in retrograde orbits, would require even more mysterious processes. Most long-period retrograde comets that “evolved” into short-period comets should still be retrograde. Very few short-period comets are retrograde. [See [Table 14](#) on page 305.]

Long-period comets are inclined at all angles and rarely become short-period comets. A slight majority of observed long-period comets are retrograde. However, almost all short-period comets are prograde and lie near Earth's orbital plane. Gravitational interactions with planets might decrease some periods, but would not

change retrograde orbits at all inclinations into prograde orbits near Earth's orbital plane.

38. ☒ *Two Separate Populations.* An Oort cloud only 10,000 AU away would be too tightly bound to the Sun to allow enough stellar perturbations for this theory to work. If the cloud were 50,000 AU away, passing stars and galactic clouds would disperse the Oort cloud in a few billion years. Fernández recommended a distance of 25,000 AU, because it allows the most comets to pass through the inner solar system after 4.5-billion years. Even if that much time were available, only about 1% of the short-period comets we see would be produced. Notice that 25,000 AU is inconsistent with Oort's 50,000–150,000 AU estimate that gave birth to this theory.

39. ☒ *Jupiter's Family.* Comets falling in from 50,000 AU would reach very high speeds. The only way to slow them down enough to join Jupiter's family is by gravitational interactions with planets. However, tidal effects would tear most comets apart or fling them out of the solar system. Those that slowed down over many orbits would continually risk colliding with planets and moons while slowly vaporizing with each passage near the Sun. Few comets would survive and join Jupiter's family.

Comets in Jupiter's family have an average life span of only about 12,000 years. They could not have accumulated over millions of years.

40. ☉ *Composition.* Same as [item 40](#) on page 322.

41. ☒ *Small Comets.* See [item 17](#) on page 320.

42. ☉ *Recent Meteor Streams.* See [item 9](#) on page 318.

43. ☉ *Crater Ages.* If an Oort cloud were populated with about 10^{12} comets 4.5-billion years ago, the Earth should have been heavily bombarded. The further back in time, the greater the bombardment rate. Craters or other evidence of this bombardment should be increasingly visible in the deeper sedimentary rock layers, but craters are almost exclusively found in surface layers.

44. ☒ *Other/Missing Star.* If a passing star deflected comets in an Oort cloud toward the Sun, where is that star? Our nearest star, Proxima Centauri, is 4.3 light-years away, or 270,000 AU. It, and the two stars gravitationally bound to it, could not have stirred up an Oort cloud, because they are moving *toward* the Sun, not away from it. A study that projected stellar motion back 10-million years found that no star would have come within 3 light-years of the Sun. Therefore, no star would have stirred up an Oort cloud 0.8–2.4 light-years away during the last 10-million years.¹²⁴ Wouldn't two passing stars be needed—one to produce prograde comets and another to produce retrograde comets?

45. ☒ *Other/Stripped Oort Cloud.* Clube and Napier have estimated that after 200-million years of travel in its

galactic orbit, the solar system should have passed through or near up to 5,000 galactic clouds (molecular clouds) whose mass is about a half million times greater than the Sun. Each cloud's gravity could be expected to strip away 25-90 percent of an Oort cloud, because the Oort cloud is supposedly so far from the Sun. The Oort cloud should have essentially disappeared long ago.¹²⁵ (Oort cloud theories have many variations; only the best known are described here.)

Details Relating to the Revised Oort Cloud Theory

46. **Formation Mechanism, Heavy Hydrogen.** Same as item 30 on page 321.

47. **Ice on Moon and Mercury.** Same as item 14 on page 320.

48. **Crystalline Dust.** Same as item 32 on page 321.

49. **Near-Parabolic Comets.** See item 33.

50. **Random Perihelion Directions.** See item 34.

51. **No Incoming Hyperbolic Orbits.** Same as item 35 on page 322.

52. **Small Perihelions.** Same as item 36 on page 322.

53. **Two Separate Populations.** Short-period comets might be explained if comets formed near the giant planets. However, this would not produce the number of needed near-parabolic comets. The average comet flung out toward an Oort cloud, but not expelled from the solar system, would end up far short of where the Oort cloud supposedly is.¹²⁶ [See [Figure 174 on page 307](#).]

54. **Jupiter's Family.** Comets in Jupiter's family have an average life span of only about 12,000 years. They could not have accumulated over millions of years.

55. **High Loss Rates of Comets.** Several locations for cometary nurseries in the giant-planet region have been proposed. Oort favored the asteroid belt, between Mars and Jupiter, if such a nursery was needed to supply the Oort cloud. Later, Fernández showed that, if comets were born near Jupiter, Jupiter would expel too many from the solar system. To account for today's high loss rate of comets from an Oort cloud would require 10,000 Earth masses of comets in a Jupiter birthing region 4.5-billion years ago—"too large to consider it dynamically reasonable."¹²⁷ Jupiter would have to fling 30 times its mass out to the Oort cloud! No planet's energy and angular momentum could have done the job.¹²⁸

Fernández favored the region between Uranus and Neptune as the place where comets were born and steadily flung out to the Oort cloud. This would require the least amount of cometary birthing material—about 17

Earth masses—or the mass of Neptune. However, Uranus and Neptune would probably not have had the necessary energy and angular momentum.

Overcrowding is another problem. If so many comets began in the giant planet region, they would often collide and fragment. Only about 5% of the comets needed by an Oort cloud could have been delivered to the Oort cloud.¹²⁹

Öpik raised a more serious problem. To form comets in the Uranus-Neptune region and then eject them out to an Oort cloud would require about 100-billion years—20 times the assumed age of the solar system.¹³⁰

In 1950, Gerard Kuiper (KI-per) theorized that material that almost formed a planet should still exist beyond Neptune, 35–50 AU from the Sun.¹³¹ This region, which some believe is filled with comets, is now called the *Kuiper Belt*. Kuiper thought that Pluto expelled the nursery's comets out to the Oort cloud. Later it was learned that Pluto's mass was much too small for the job.

Since 1992, ground-based telescopes, the Hubble Space Telescope, and other techniques have detected more than 70,000 large objects in the Kuiper Belt,¹⁰⁹ a region that some had hoped was the source of comets in the solar system and in the Oort cloud. Later, it was realized that these objects were ten times too large (30–1,500 miles in diameter) to be comets and too few in number. A reexamination of that region of the sky by the Hubble Space Telescope has failed to detect a comet reservoir.¹³² Besides, the hydro-plate theory provides a simple explanation for the Kuiper Belt. [See ["The Origin of Trans-Neptunian Objects \(TNOs\)" on page 356](#).]

56. **Composition.** Same as item 40 on page 322.

57. **Small Comets.** See item 17 on page 320.

58. **Recent Meteor Streams.** See item 9 on page 318.

59. **Crater Ages.** This theory requires a comet nursery containing at least 10^{13} comets.¹³³ As the giant planets fling some comets out to an Oort cloud, other comets would frequently bombard Earth from close range. The further back in time, the greater the bombardment rate. As with the original Oort cloud theory, craters from this intense bombardment should be increasingly visible the deeper one looks in Earth's sedimentary layers. Instead, craters are almost exclusively found in surface layers.

60. **Other/Missing Star.** Same as item 44 on page 322.

Details Relating to the Meteor Stream Theory

61. **Formation Mechanism.** Particles colliding in space tend to fragment, not merge.¹³⁴ Second, even if they always stuck together, they would grow very slowly—on the order of 3-billion years for gas to form particles only 10^{-5}

cm in diameter.¹³⁵ Third, dust particles that formed this way would be more uniform in size than those in comets. Fourth, colliding ice particles would vaporize the weakly bound ice molecules, destroying, not forming, comets.

62. ❌ **Ice on Moon and Mercury.** Same as item 14 on page 320.

63. ❌ **Crystalline Dust.** Same as item 32 on page 321.

64. ⚪ **Random Perihelion Directions,** ⚪ **Orbit Directions and Inclinations.** Particles in meteor streams were supposedly formed by the same unknown process as particles that now compose planets. If so, meteoroids and comets would have prograde orbits near the ecliptic. However, 53% of the observed long-period comets are in retrograde orbits, and almost all are far from the ecliptic.

65. ❌ **Small Perihelions.** Passing stars might perturb long-period comets, but comet perihelions would be scattered—not clustered, as they are, in the 1–3 AU range.

66. ❌ **Jupiter's Family.** Same as item 54 on page 323.

67. ⚪ **Composition.** Same as item 40 on page 322.

68. ❌ **Heavy Hydrogen.** Comets have 20 times more heavy hydrogen than this theory would predict.

69. ❌ **Small Comets.** See item 17 on page 320.

70. ⚪ **Missing Meteorites.** See item 18 on page 320.

71. ⚪ **Recent Meteor Streams.** See item 9 on page 318.

72. ❌ **Other/Scattering.** Solar wind, the Poynting-Robertson effect, perturbations by planets, and tidal effects disperse particles in a meteor stream, preventing them from merging to become a comet.

As the water in a short-period comet evaporates into the vacuum of space, its dust particles remain in orbits similar to the comet's orbit. Thus, comets produce meteor streams, not the reverse.

Details Relating to the Interstellar Capture Theory

73. ❌ **Formation Mechanism.** In space, small particles colliding at high speeds rarely stick together. Because these particles have tiny spheres of influence, they should hardly ever capture each other to form larger particles—let alone comets—even over billions of years. Besides, collisions, which would occur only rarely, would be more likely to *scatter* any grouping of particles held together by their weak mutual gravity than to form larger particles. No experimental evidence has shown how particles could merge or condense in the vacuum of space, or how they would produce such a wide range of sizes.

Even if billions of dust particles somehow stuck together to form pebbles, each pebble would be a long way from being

the size of a comet. As the pebbles fell toward the Sun, their spheres of influence would shrink, not grow. Nor would gases surround each pebble to assist in capture. Therefore, they would not merge into larger clusters to form comets.

74. ❌ **Ice on Moon and Mercury.** Same as item 14 on page 320.

75. ❌ **Crystalline Dust.** Same as item 32 on page 321.

76. ❌ **Random Perihelion Directions,** ❌ **Orbit Directions and Inclinations.** If comets formed on a converging axis between the Sun and a colliding dust or gas cloud, as this theory proposes (page 313), perihelions and orbital planes should lie in specific directions; they do not.

77. ❌ **Small Perihelions.** If long-period comets formed along a converging axis that extended perhaps 50,000 AU from the Sun, many should fall directly into the Sun from a specific direction. This is not observed.

78. ❌ **Jupiter's Family.** Same as item 39 on page 322.

79. ⚪ **Composition.** Same as item 40 on page 322.

80. ❌ **Heavy Hydrogen.** Same as item 68 on page 324.

81. ❌ **Small Comets.** See item 17 on page 320.

82. ⚪ **Missing Meteorites.** See item 18 on page 320.

83. ⚪ **Recent Meteor Streams.** See item 9 on page 318.

Another Possibility: Creation

Some might say that comets were created along with the Sun, Moon, and stars, but that view cannot by itself qualify as a scientific theory. Good scientific theories relate and explain, through well-established cause-and-effect relationships (the laws of physics), many otherwise strange observations. Little, if any, historical or scientific evidence supports *or refutes* the proposal that comets were created in the beginning. Such claims raise many questions about strange comet characteristics and patterns. The simplest explanation that is consistent with the laws of physics and explains many diverse, otherwise puzzling, observations is probably the best—regardless of the starting point. [See “[How Can the Study of Creation Be Scientific?](#)” on page 438.]

Final Thoughts

People are usually surprised at how many theories try to explain comet origins. Ironically, most theories explain the facts better than the theory currently in vogue—the Oort cloud theory. Having only one theory popularized or taught, usually as a fact, leads to its dominance and continuation as the only theory taught—despite a growing number of scientific problems.

Thomas Kuhn wrote the preeminent book on how science works.¹³⁶ In it, he shows that such monopolies continue in science, often for centuries, until startling new evidence arises along with a theory that better explains all the evidence. Then, a slow reeducation process begins, accompanied by hostility from those whose income, power, pride, and prestige are rooted in the old theory or paradigm.

If, as you drove across the country, you found more and more details contradicting your map, you might suspect that you made a wrong turn somewhere. Admitting a mistake may be difficult, and backtracking and finding the correct

road can consume time and fuel. In science, *paradigm shifts* are costly and slow, damage some reputations and businesses, and even destroy major worldviews of certain segments of society. Fundamental changes in thinking are strenuously resisted by some, but are inevitable if the scientific evidence supports those changes.

New evidence spawns new theories, and the testing cycle begins again. However, when only one explanation is taught and seldom questioned, the cycle stops. In science, we should never think we have a final or proven answer.

References and Notes

1. Scott A. Sandford et al., “Organics Captured from Comet 81P/Wild 2 by the Stardust Spacecraft,” *Science*, Vol. 314, 15 December 2006, pp. 1720–1724.
 - ◆ Bill Steigerwald, “NASA Researchers Make First Discovery of Life’s Building Block’s in Comet,” NASA Goddard Space Flight Center, 17 August 2009, www.nasa.gov/mission_pages/stardust/news/stardust_amino_acid.html
 - ◆ “Other clues about [comet 67P’s] origins came from the spacecraft’s chemical sensors. Scanning the surface, for instance, a spectrometer detected an absorption feature associated with complex organic molecules that could include carboxylic acids—precursors to amino acids. ... NASA’s Stardust mission found actual amino acids in comet dust it sampled in 2004—but the molecules Rosetta has detected are more complex than those seen on other comets.” [A final list of these complex molecules is in [Table 15 on page 309](#).] Eric Hand, “Comet Close-up Reveals a World of Surprises,” *Science*, Vol. 347, 23 January 2015, pp. 358–359.
 - ◆ F. Capaccioni et al., “The Organic-Rich Surface of Comet 67P/Churyumov-Gerasimenko as Seen by VIRTIS/Rosetta,” *Science*, Vol. 347, 23 January 2015, pp. 389.
 2. “We know that it is hard to find a comet **without** the spectral features of C₂, C₃, and CN in their comas. Huggins was struck by the fact that the material in the comets was similar to organic matter of unquestioned biological origin on Earth. Many scientists cautiously concluded that the carbon compounds found by [William] Huggins [in 1868] in the comas of comets were, as one of his contemporaries wrote, ‘the result of the decomposition of organic bodies.’” [emphasis in original] Carl Sagan and Ann Druyan, *Comet* (New York: Ballantine Books, 1997), p. 148.
 - ◆ “Recent observations of comet celebrities Halley, Hale-Bopp and Hyakutake [Hyah-koo-tah-kay] revealed that these icy visitors are rife with organic compounds. In 1986 cameras on board the Giotto and Vega spacecrafts captured images of dark material on Halley’s surface that resembles the coallike kerogen in some meteorites, and mass spectrometers caught glimpses of carbon-rich molecules. More recently, ground-based telescopes inspecting the coma and tail of comets Hyakutake and Hale-Bopp distinguished a number of specific organic compounds, including methane and ethane.” Max P. Bernstein et al., “Life’s Far-Flung Raw Materials,” *Scientific American*, Vol. 281, July 1999, p. 45.
 3. M. A. Cordiner et al., “Mapping the Release of Volatiles in the Inner Comae of Comets C/2012 F6 (Lemmon) and C/2012 S1 (ISON) using the Atacama Large Millimeter/Submillimeter Array,” *The Astrophysical Journal Letters*, Vol. 792, 1 September 2014, pp. 1–6.
 - ◆ “Astronomers have captured three-dimensional images of organic compounds streaming from two comets [in clumps: hydrogen cyanide (HCN), hydrogen iso-cyanide (HNC), and formaldehyde (H₂CO)].” Martin Cordiner, “Comets Forge Organic Molecules,” *Nature*, Vol. 512, 21 August 2014, p. 234.
 - ◆ “The COSAC [COmetary SAMpling and Composition apparatus] gas analyzing instrument on Philae [the Rosetta lander that landed on Comet 67P on 12 November 2014] was able to ‘sniff’ the atmosphere and detect the first organic molecules after landing, the DLR German Aerospace Center said.” Victoria Bryan, “Comet Team Detects Organic Molecules, Basis of Life on Earth,” www.reuters.com/article/2014/11/18/us-space-comet-idUSKCN0J21V520141118
- The comet’s atmosphere contained methane, the simplest organic molecule. Methane almost always comes from life, which means that life (such as bacteria) once was, or is, probably on Comet 67P. In rare cases, methane can be produced in other ways, such as when liquid water interacts with certain rocks. However, comets are too cold to have liquid water. Even if comets heated up by traveling close to the Sun or by an impact, the comet’s ice would immediately become a gas (steam), never liquid water. Therefore, bacteria probably were or are on Comet 67P—bacteria launched from Earth. Don’t be fooled by claims that life on Earth came from comets or extraterrestrial bodies. Those ideas, called *panspermia*, beg the question of how life began, ignore all the deadly radiation in space, and don’t tell us what the critters ate. As shown in [Table 15 on page 309](#), in 2009 scientists discovered many highly complex organic molecules such as glycine, on a comet. Glycine definitely came from life.
4. If A and B have a similar and unusual characteristic, or they correlate, some might claim that A caused B. But maybe B caused A—or C caused A and B. Perhaps no cause-and-effect link exists. Many humorous stories, scams,

and even misguided scientific efforts are rooted in this logical fallacy—seeing a relationship and, with no other information, assuming a specific cause produced an effect.

Because (A) traces of organic molecules are found in comets, and (B) organic molecules are found in every living thing on Earth, did comets bring life to Earth (A caused B)? **Maybe comets and organic molecules came from Earth** (B caused A). We should consider all possibilities. Many who leap to conclude that comets explain life on Earth know how difficult it is to explain life originating by natural processes. Most authorities will privately admit that life is so complex that they can't imagine how it could form anywhere. [See pages 14–25.] Desperation may force this poor logic—that comets brought life to Earth. But even if comets did, how did comets acquire life? It takes more than time and distance.

Be aware that organic molecules—which are simply molecules containing hydrogen plus carbon rings or chains—are as far from becoming life as bricks are from becoming the Empire State Building. Yes, bricks might form naturally in a dried-up stream bed, but I cannot imagine the Empire State Building forming by natural processes. *If you saw a large pile of bricks mixed with steel, tubes, wire, glass, and insulation, would you conclude that a building was evolving or had been destroyed?* Great intelligence is needed to produce life.

5. The Deep Impact space mission found that the nucleus of comet Tempel 1 had a density of 0.62 gm/cm³ and was about 60% empty space. If the dirt's density was 2.7 gm/cm³ and the ice's density was 0.92 gm/cm³, it can be shown that about 38% of the comet, by mass, was water. [See M. F. A'Hearn et al., "Deep Impact: Excavating Comet Tempel 1," *Science*, Vol. 310, 14 October 2005, p. 262, and Richard A. Kerr, "Deep Impact Finds a Flying Snowbank of a Comet," *Science*, Vol. 309, 9 September 2005, p. 1667.]
6. G. Gloeckler et al., "Interception of Comet Hyakutake's Ion Tail at a Distance of 500 Million Kilometers," *Nature*, Vol. 404, 6 April 2000, pp. 576–578.
7. John Fleck, "Comets Showered Ice on Moon," *ABQ Journal of Science & Technology*, 3 September 1998, p. C3.
8. *Infrared spectroscopic measurements of the lunar surface from [three] spacecraft provide unambiguous evidence for the presence of hydroxyl (OH) or water [or both].* Paul G. Lucey, "A Lunar Waterworld," *Science*, Vol. 326, 23 October 2009, p. 531.
9. W. C. Feldman et al., "Fluxes of Fast and Epithermal Neutrons from Lunar Prospector: Evidence for Water Ice at the Lunar Poles," *Science*, Vol. 281, 4 September 1998, p. 1496.
10. Nancy L. Chabot et al., "Images of Surface Volatiles in Mercury's Polar Craters Acquired by the MESSENGER Spacecraft," *Geology*, Vol. 42, December 2014, pp. 1051–1054.
11. *But the association of comets with catastrophe remains curiously steady through the generations.* Sagan and Druyan, p. 279.
 - ◆ *Here, as indeed among all peoples generally, comets are regarded as omens of disaster.* Fred Hoyle and Chandra Wickramasinghe, *Lifecloud* (New York: Harper & Row, Publishers, 1978), p. 99.
12. Nigel Calder, *The Comet Is Coming!* (New York: The Viking Press, 1980), pp. 13, 26.
 - ◆ Loren Coleman list several "suicide epidemics" in his book, *The Copycat Effect* (Simon & Schuster, Inc., New York, 2004), pp. 77–79.
13. Isaac Newton, "Of the Attractive Forces of Spherical Bodies," Proposition LXX, Theorem XXX, Section XII, Book I, *The Principia* (1687; reprint, Amherst, New York: Prometheus Books, 1995), p. 154. The shell must have uniform thickness and density.
14. The Apollo 13 astronauts had to abort their planned lunar landing, because an oxygen tank exploded soon after liftoff. This forced them to loop around the Moon and execute a tricky reentry back to Earth. Ground controllers had difficulty tracking the spacecraft by radar, because a cloud of urine orbited and partially hid the spacecraft. The astronauts were then told to hold all waste liquid in onboard containers. Today, astronauts avoid this problem by dumping waste material overboard just before igniting their rocket thrusters. Gravity, even that of a spacecraft, a rock, or a water droplet, acts on everything.
15. It can be shown that the radius of a sphere of influence (SoI) of a spherical rock of radius r that is moving away from Earth is about

$$0.65 \left(1 + \frac{h}{R} \right) r$$
 where R is the Earth's radius and h is the rock's height above the Earth.

When *many* particles (rocks, dirt, ice, and water molecules, all moving away from Earth) interact and exchange momentum, their velocities become more similar. The effective SoI of the combined mass increases, so those particles will increasingly tend to merge.
16. An extremely rare exception might occur if one body strikes the other with a very delicate glancing blow. Another exception would be if a third particle passing by had just the right mass, speed, direction, and position so that its gravitational attraction could slow the droplet enough to cause capture. However, impacts and interfering third bodies are much more apt to cause scattering than capture.
17. Every body, even a dust particle or a star, has an **escape velocity**—that is, the slowest speed an arbitrary object needs from a specified point to escape that body's gravity pull and go to infinity. The escape velocity for an object at the surface of the Earth, is 11.2 km/sec (7.0 mi/sec). For something at the surface of the Sun to escape the solar system, it is 617.2 km/sec (383.5 mi/sec). For something 1 AU from the Sun to escape the solar system requires 42.3 km/sec (26.3 mi/sec).
18. "Capture" is the proper term. Those who say stars, planets, and moons formed through capture often use the misleading terms "accrete," "condense," and "gravitational collapse," which imply a "pulling in." These words, while sounding scientific

to a layman, reveal a misunderstanding of the physics. While gravity would move two isolated particles in space toward each other if their relative velocity were initially zero, particles in space are not isolated and seldom travel with the same speed and direction. For a body to capture a particle, (a) the particle must be within the body's sphere of influence, (b) the particle's velocity relative to the body must never carry it outside the sphere of influence, and (c) the body's gravitational grip on the particle must increase, so later perturbations do not strip the orbiting particle away. Requirement (c) is most easily satisfied if the body has an atmosphere—a surrounding gas. [See “[Evolving Planets?](#)” on page 29.]

19. “*It turns out to be surprisingly difficult for planetesimals to accrete mass during even the most gentle collisions.*” Erik Asphaug, “The Small Planets,” *Scientific American*, Vol. 282, May 2000, p. 54.

◆ In 1805, Laplace first explained the “sphere of influence” concept, or, as he called it, the “sphere of attraction.” He applied it to planets acting on comets, but did not use it to show why permanent capture to form larger bodies, such as comets or planets, is so difficult. [See Nathaniel Bowditch, *Celestial Mechanics* by the Marquis de Laplace, Vol. 4 (Bronx, New York: Chelsea Publishing Co., 1966), pp. 417–437.]

20. Unfortunately, “short-period comets” have been arbitrarily defined as comets with periods less than 200 years. A more physically meaningful definition, used here, will be *comets with periods less than 100 years*, because there is a huge, recognized excess of such comets. Any acceptable theory of comet origins should explain this excess.

21. All orbital information was taken on 30 October 2016 from the Jet Propulsion Laboratory’s Small-Body Data Base at http://ssd.jpl.nasa.gov/sbdb_query.cgi

22. Disregarding the effects of wind resistance, fired bullets and thrown balls are very briefly in elliptical orbits about Earth’s center of mass. Once they strike the Earth’s surface, their orbits end.

23. “*Jupiter’s huge attractive mass has somehow collected two-thirds of all the short-period comets into a family. Saturn probably also plays a supporting role in the process. Jupiter and Saturn appear to be much more important in the story of comets than was indicated by their slight disturbances of the motion of Halley’s comet. The existence of Jupiter’s comet family is one of our important clues to the origin of comets.*” Fred L. Whipple, *The Mystery of Comets* (Washington, D.C.: Smithsonian Institution Press, 1985), p. 74.

“*What is the chance that Jupiter could catch them [comets falling from an Oort cloud] by its gravity and tame them into short-period, prograde orbits? He [H. A. Newton] found that the chance is very small. Only about one in a million would have its period reduced to less than Jupiter’s period of 11.86 years.*” *Ibid.*, p. 75.

24. “*By comparing the orbital element distribution of JFCs [Jupiter’s family of comets] to that produced by our simulations we deduce that JFCs are statistically most likely*

to have physical lifetimes of about 12,000 years.” Harold F. Levison and Martin J. Duncan, “From the Kuiper Belt to Jupiter-Family Comets,” *Icarus*, Vol. 127, May 1997, p. 13.

◆ “*But once so deflected [into short-period orbits], these comets must have comparatively short lifetimes, astronomically speaking, and probably no short-period comet can survive more than about 10,000 years.*” R. A. Lyttleton, *Mysteries of the Solar System* (Oxford, England: Clarendon Press, 1968), p. 110.

25. “*There is no example of a known short-period comet evolving into a long-period comet of small enough perihelion to be visible.*” Edgar Everhart, “Examination of Several Ideas of Comet Origins,” *The Astronomical Journal*, Vol. 78, May 1973, p. 332.

26. Harold F. Levison and Martin J. Duncan, “The Long-Term Dynamical Behavior of Short-Period Comets,” *Icarus*, Vol. 108, March 1994, Figure 5, p. 25.

27. Many of these comets are so far away and have not been observed long enough for their orbital periods to be calculated.

28. This can be seen by recalling the “**Hollow Shell**” example on [page 303](#). The Kuiper Belt (and to a lesser extent, the asteroid belt) can be thought of as approximately consisting of thousands of thin, concentric, spherical shells—like rings in an onion. A comet inside any shell would not feel its gravitational pull. However, comets outside a shell would feel, for up to thousands of years, a gravitational pull equal to that of the shell’s entire mass concentrated at the center of that shell.

29. “*Many scientific papers are written each year about the Oort Cloud, its properties, its origin, its evolution. Yet there is not a shred of direct observational evidence for its existence.*” Carl Sagan and Ann Druyan, p. 210.

However, Sagan and Druyan believed that the Oort cloud exists, and went on to predict (p. 211) that “*with the refinement of our scientific instruments, and the development of space missions to go far beyond Pluto,*” the cloud will be seen, measured, and studied. As of 2018, that prediction is unfulfilled.

30. Raymond A. Lyttleton, “The Non-Existence of the Oort Cometary Shell,” *Astrophysics and Space Science*, Vol. 31, December 1974, pp. 385–401.

Assuming the Oort cloud exists helps preserve the belief in a multibillion-year age for the solar system.

◆ “*Recently, Lyttleton (1974) confirmed our conclusion of 1954: the Oort’s hypothetical cloud of comets cannot exist.*” S. K. Vsekhsvyatsky, “Comets and the Cosmogony of the Solar System,” *Comets, Asteroids, Meteorites*, editor A. H. Delsemme (Toledo, Ohio: The University of Toledo, 1977), p. 470.

Vsekhsvyatsky estimated (p. 470) that considerably more than 10^{20} gm/yr of cometary matter are lost from the solar system. Over the supposed age of the solar system (4.5-billion years), lost comet mass would “*nearly correspond to the total present mass of the planets.*” He believed this was unreasonable. I agree.

“*... many people would be happier if there were more objective evidence for the reality of the Oort Cloud.*” John

Maddox, “Halley’s Comet Is Quite Young,” *Nature*, Vol. 339, 11 May 1989, p. 95.



PREDICTION 36: The Oort cloud will never be detected, because it does not exist.

31. “Using current standard models for the formation of comets, a significant number of [hyperbolic] comets should have been observed. This lack of detections of extrasolar comets is becoming an embarrassment to the theories of solar system and cometary formation and may drive the parameters of these models.” Thomas A. McGlynn and Robert D. Chapman, “On the Nondetection of Extrasolar Comets,” *Astrophysical Journal*, Vol. 346, 15 November 1989, p. L105.
 - ◆ “No comet on a clearly interstellar trajectory has been observed passing through the planetary system.” Paul R. Weissman, “Dynamical History of the Oort Cloud,” *Comets in the Post-Halley Era*, Vol. 1, editors R. L. Newburn et al. (Boston: Kluwer Academic Publishers, 1991), p. 479.
 - ◆ “[Evolutionary] models predict that the Milky Way Galaxy should be awash with such ‘rogue’ objects, because huge numbers of asteroids and comets are thought to be ejected from young planet-forming systems. However, surveys have found no objects that have been confirmed as interstellar.” Francesca Cesari et al., “Rogue Asteroids May Be Rare,” *Nature*, Vol. 544, 13 April 2017, p. 141.
 - ◆ “No comet has ever been observed on a trajectory originating outside the gravitational influence of the Sun. And yet, sooner or later, such comets should be seen.” Sagan and Druyvan, p. 350.



PREDICTION 37: No incoming comet will ever be seen on a hyperbolic orbit, because cometary material came from Earth as the flood began, not from outside the solar system.

32. “A flaw in our understanding of the orbital evolution of comets is that the number of short-period comets—those with orbital periods less than 200 years, such as comet Halley—is much greater than theory predicts. The discrepancy is enormous; the observed number is two orders of magnitude larger than expected.” Julia Heisler, “Orbital Evolution of Comets,” *Nature*, Vol. 324, 27 November 1986, p. 306.
33. This expected distribution of comets, first shown mathematically by van Woerkom in 1948, has frequently been verified by powerful computer simulations. [See A. J. J. van Woerkom, “On the Origin of Comets,” *Bulletin of the Astronomical Institutes of the Netherlands*, Vol. 10, 8 December 1948, pp. 445–472.]
 - ◆ A few researchers once believed that second-pass comets were not visible, because they dimmed after losing volatile gases on their first pass. This early loss of volatiles happens, but the effect is not strong. Comets moving away from the Sun are not appreciably dimmer than when they were at the same distance but approaching the Sun. [See M. C. Festou, “The Derivation of OH Gas Production Rates from Visual Magnitudes of Comets,” *Asteroids Comets Meteors II*,

editors C. I. Lagerkvist et al. (Uppsala, Sweden: Uppsala University Press, 1986), pp. 299–303.]

Wiegert simulated 125,495 artificial comets in orbits 10,000–50,000 AU from the Sun. For 5 billion simulated years, the giant planets and the galactic tide perturbed the comets. Even when simulating comets that rapidly fade in visibility, Wiegert found that neither fading nor many other effects could explain the lack of observed long-period comets that have completed more than one orbit. [See Paul Arnold Wiegert, *The Evolution of Long-Period Comets* (Ph.D. dissertation, University of Toronto, 1996).]

- ◆ Thomas D. Nicholson, “Comets, Studied for Many Years, Remain an Enigma to Scientists,” *Natural History*, Vol. 75, March 1966, pp. 44–46.
 - ◆ Lyttleton, *Mysteries*, p. 110.
 - ◆ Hannes Alfvén and Gustaf Arrhenius, *Evolution of the Solar System* (Washington, D.C.: NASA, 1976), p. 234.
34. “Since planetary perturbations typically change $1/a$ [a quantity proportional to energy per unit mass] by several hundred units during one revolution about the Sun, we were forced to conclude, following Oort, that the great majority of these [near-parabolic comets] comets were making their first passage through the inner part of the solar system.” Brian G. Marsden et al., “New Osculating Orbits for 110 Comets and Analysis of Original Orbits for 200 Comets,” *The Astronomical Journal*, Vol. 83, January 1978, p. 64.
 35. “Hence, if comets like Hale-Bopp brought in the Earth’s water, they would have brought in a factor of 40,000 times more argon than is presently in the atmosphere.” T. D. Swindle and D. A. Kring, “Implications of Noble Gas Budgets for the Origin of Water on Earth and Mars,” *Eleventh Annual V. M. Goldschmidt Conference*, Abstract No. 3785 (Houston: Lunar and Planetary Institute, 20–24 May 2001).

Argon is not commonly found in outer space, and it is a noble gas, so it doesn’t react chemically with other matter. How then did comets collect argon?

Argon was probably produced by solar wind striking chlorine in the frozen saltwater that comprises much of a comet. (Protons constitute 95% of the solar wind.) Protons (p) bombarding chlorine (Cl) produce argon (Ar) and a gamma ray (γ), a process called *proton capture*. For example:

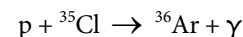

This reaction would have begun long before comets gravitationally assembled from the material in the fountains of the great deep. After comets assembled, primarily the outer shell of comets would have been increasingly enriched with argon. The argon content in comet Hale-Bopp was measured in the gases that vaporized from Hale-Bopp’s outer shell, so we cannot assume that the entire comet had such a high argon enrichment. Nevertheless, if comets supplied most of Earth’s water, we probably would see much more argon in our atmosphere than we have, although it would not be 40,000 times as much.



PREDICTION 38: A greater concentration of argon will be found in the outer portions of comets.

Sodium, which few would expect to find in outer space, was one of the first chemical elements identified in comets. [See Donald K. Yeomans, *Comets* (New York: John Wiley & Sons, Inc., 1991), p. 217.]

36. “Comet investigators found levels of ethane in Comet Hyakutake that are about 1,000 times greater than can be explained if the molecules were formed by normal physical processes within the gases of the primordial solar nebula, the birth cloud of the Solar System.” Douglas Isbell and Jim Sahli, “Chemical Measurements of Comet Hyakutake Suggest a New Class of Comets,” NASA Press Release 96–108, 31 May 1996.
37. “Scientists have been catching hints of methane in the Martian atmosphere for 15 years using Earth-based telescopes, Mars orbiters and NASA’s Curiosity rover. As evidence of the gas has accumulated, the debate over its origin has intensified. Nearly 95% of all methane in the Earth’s atmosphere originated from current and past biology.” Nisha Gaiind, “Probe Tackles Mars Methane Mystery,” *Nature*, Vol. 556, 26 April, 2018, p. 419.
38. “But an old reservoir of methane [on Mars] is problematic, Mumma says, because it would be hard to explain how it could be steadily released over billions of years. That would suggest that if bacteria are indeed the source of the methane, the organisms are active now.” Ron Cowen, “Plumes of Martian Methane Hint at Possible Underground Microbial Life,” *Science News*, Vol. 175, 14 February 2009, p. 10.
- ◆ “... the destruction lifetime for CH₄ [methane] is much shorter than the time scale (~350 years) estimated for photochemical destruction. Another process thus must dominate removal of atmospheric CH₄ on Mars, and it must be more efficient than photochemistry by a factor > 100.” Michael J. Mumma et al., “Strong Release of Methane on Mars in Northern Summer 2003,” *Science*, Vol. 323, 20 February 2009, p. 1044.
 - ◆ Alexandra Witze, “Clues Emerge to Martian Mystery,” *Nature*, Vol. 563, 1 November 2018, pp18–19.
39. “Krasnopolsky’s team calculates that comets striking Mars couldn’t deliver enough methane to replace what’s lost.” Ron Cowen, “Martian Methane: Carbon Compound Hints at Life,” *Science News*, Vol. 165, 10 April 2004, p. 228.
40. Christopher R. Webster, et al. “Background Levels of Methane in Mars’ Atmosphere Show Strong Seasonal Variations,” *Science*, Vol. 360, pp. 1093–1096, 8 June 2018.
- ◆ “But in late March, researchers analyzing data from the European Mars Express satellite reported the planet’s atmosphere contains traces of methane, [usually] a by-product of bacteria here on Earth. Could this be the long-awaited sign of Martian life?” Maia Weinstock, “Our Favorite Martians,” *Discover*, Vol. 25, August 2004, p. 16.
 - ◆ “Living systems produce more than 90% of Earth’s atmospheric methane; the balance is of geochemical origin [if liquid water is present].” Mumma et al., p. 1041.
- Because Mars is so cold, almost all water on Mars is ice. What little liquid water is seeping out of Mar’s soil today is only because the water contains dissolved salts which lower the water’s freezing temperature. But those salts could only have dissolved in the water when it was a liquid. Where and when was that water liquid? On Earth before the flood.
41. Eric Hand, “Mars Rover Finds Long-Chain Organic Compounds,” *Science*, Vol. 347, 27 March 2015, p. 1402.
42. “... there is no reasonable astronomical scenario in which mineral grains can condense [in space].” Fred Hoyle and Chandra Wickramasinghe, “Where Microbes Boldly Went,” *New Scientist*, Vol. 91, 13 August 1981, p. 413.
- ◆ “Although very little is known about how the [dust] grains are formed, observations of interstellar matter indicate that the process must be very efficient; otherwise, how could the striking depletion of the refractory elements [such as silicon and magnesium] in the interstellar gas be explained?” Hubert Reeves, “Comets, Solar Wind and the D/H Ratio,” *Nature*, Vol. 248, 29 March 1974, p. 398.
- My Translation: No one knows how dust could form in space, but dust formation must be very efficient, because few of the chemical elements needed to form dust are there. (We know that dust formed in space, because dust is in space. 😊)
- My Response: Maybe the dust in comets came not from almost-empty space, but from Earth.
43. “As in the interstellar medium, much of the dust from comets consists of silicate minerals, but despite the similarities, there are puzzling differences. For example, interstellar dust shows the absorption signature of amorphous particles with a silicate composition, whereas Hale-Bopp and other comets have crystalline silicate, probably in the form of magnesium-rich olivine.” Dale P. Cruikshank, “Stardust Memories,” *Science*, Vol. 275, 28 March 1997, p. 1896. [See also pp. 1904–1909.]
- ◆ Humberto Campins and Eileen V. Ryan, “The Identification of Crystalline Olivine in Cometary Silicates,” *The Astrophysical Journal*, Vol. 341, 15 June 1989, pp. 1059–1066.
 - ◆ “In particular, the resonance peak seen at 11.2 μm [in the impact debris from comet Tempel 1] is indicative of Mg-rich crystalline olivine.” K. J. Meech et al., “Deep Impact: Observations from a Worldwide Earth-Based Campaign,” *Science*, Vol. 310, 14 October 2005, p. 267.
44. Could interstellar dust, which has no crystalline pattern, have melted (or almost melted), cooled, crystallized, and then acted as condensation sites for water-ice that formed comets? Probably not. Had nonspherical dust particles melted, or almost melted, they would have become spherical due to their surface tension. Interstellar dust particles polarize starlight, so they must be elongated. Therefore, cometary dust is probably not derived from heated interstellar dust.
45. M. F. A’Hearn et al., pp. 258–264.
46. “The existence of hydrated silicates [silicates altered by liquid water] in comets is provocative, because it would suggest the presence of abundant amounts of reactive water in the formation region of the comet or in the cometary parent body.”

- Carey M. Lisse et al., “Spitzer Spectral Observations of the Deep Impact Ejecta,” *Science*, Vol. 313, 4 August 2006, p. 637.
- “The presence of carbonates is provocative because, like the phyllosilicates, liquid water was thought to be required to form carbonates from CO₂ in the presence of silicates.”* Ibid.
- ◆ These results are “provocative” only if you didn’t realize that the material in comets came from the Earth—the water planet.
47. “[Comet Tempel 1 is] *the size of a mountain held together with the strength of the meringue in a lemon meringue pie.*” Carey M. Lisse, as quoted by Ron Cowen, “Deep Impact,” *Science News*, Vol. 168, 10 September 2005, p. 169.

“[The comet’s] structure is more fragile than that of a soufflé ...” Jay Melosh, as quoted by Ron Cowen, Ibid., p. 168.

 48. Daniel Clery, “Rosetta Ends 2-Year Comet Mission with Final Descent,” *Science*, Vol. 353, 30 September 2016, p. 1482.
 49. *“The observation of the CO₂ ice-rich spot was unexpected at these heliocentric distances, given the high volatility of CO₂”* G. Filacchione, et al. “Seasonal Exposure of Carbon Dioxide Ice on the Nucleus of Comet 67P/Churyumov-Gerasimenko,” *Science*, Vol. 354, 23 December 2016, p. 1565.
 50. *“In dust samples from comet Wild 2 brought back by the Stardust mission, the simplest amino acid, glycine, has been found.”* Kathrin Altwegg et al., “Prebiotic Chemicals—Amino Acid [glycine] and Phosphorus—in the Coma of Comet 67P/Churyumov-Gerasimenko,” *Science Advances*, 27 May 2016, doi: 10.1126/sciadv.1600285, p. 2.
 51. *“The most abundant minerals [in comets] are the crystalline silicate minerals, olivine and pyroxene, along with troilite (FeS). These are very stable phases, common in planetary materials; however, finding them here is somewhat surprising because many expected that cometary material would be similar to interstellar material, in which most silicates are believed to be amorphous. In contrast, cometary amorphous material in the returned samples is rare or nonexistent.”* Don S. Burnett, “NASA Returns Rocks from a Comet,” *Science*, Vol. 314, 15 December 2006, p. 1710.
 52. *“Current thinking suggests that it is impossible to form liquid water inside of a comet.”* Dante Lauretta, as quoted by Daniel Stolte, “Frozen Comet Had a Watery Past, UA Scientists Find,” UA News, 7 April 2011.
 53. Berger, Eve et al., “Evidence for Aqueous Activity on Comet 81P/Wild2 from Sulfide Mineral Assemblages in Stardust Samples and CI Chondrites,” *Geochimica et Cosmochimica Acta*, Vol. 75, 2011, pp. 3501–3513.
 54. Fred Goesmann et al., “Organic Compounds on Comet 67P/Churyumov-Gerasimenko Revealed by COSAC Mass Spectrometry,” *Science*, Vol. 349, 31 July 2015, p. 497.
 - ◆ Altwegg et al., pp. 1–13. 55. *“Oxygen molecules are also rare in the cosmos”* Christopher Crockett, “Oxygen in Comet Surprises Scientists,” *Science News*, Vol. 188, 28 November 2015, p. 6.
 56. A. Bieler et al., “Abundant Molecular Oxygen in the Coma of 67P/Churyumov-Gerasimenko,” *Nature*, Vol. 526, 29 October 2015, p. 678.
 57. Crockett, p. 6.
 58. <http://news.yahoo.com/discovery-oxygen-comet-big-surprise-181858811.html>
 59. Hoyle and Wickramasinghe, *Lifecloud*, pp. 87–113.

For two decades, these authors led a growing belief among scientists that comets are bringing cellulose, bacteria, and other organic matter to Earth.

 - ◆ Hoyle and Wickramasinghe, “Where Microbes Boldly Went,” pp. 412–415. 60. Hoyle and Wickramasinghe, *Lifecloud*, p. 91.
 61. *“The cellulose strand is a complex structure, and one can wonder how a giant molecule of such a highly organized form could be present in interstellar space.”* Ibid., p. 94.
 62. Roland Meier et al., “A Determination of the HDO/H₂O Ratio in Comet C/1995 O1 (Hale-Bopp),” *Science*, Vol. 279, 6 February 1998, pp. 842–844. [Similar and consistent measurements, with twice the deuterium concentration as today’s oceans, have also been made in comets Halley, Hyakutake, 2002T7, and Tuttle. However, Comet Hartley 2 has a concentration similar to Earth’s oceans. Hartley 2’s material may have been launched early in the flood (before deuterium built up in the subterranean chambers) or it may contain considerable surface water from the pre-flood Earth.]
 - ◆ The deuterium to hydrogen ratio in Comet 67P was 3.4 times that of Earth’s water. See Kathrin Altwegg et al., “67P/Churyumov-Gerasimenko, a Jupiter Family Comet with a High D/H Ratio,” *Science Online*, 10 December 2014, p. 1.
 - ◆ Roland Meier and Tobias C. Owen, “Cometary Deuterium,” *Space Science Review*, Vol. 90, Nos. 1–2, 1999, pp. 33–43. 63. A. Vidal-Madjar, “Interstellar Helium and Deuterium,” *Diffuse Matter in Galaxies*, editors J. Audouze et al. (Boston: D. Reidel Publishing Co., 1983), pp. 57–94.
 64. Of the hundred or so important publications on this topic, the following is most recommended: Louis A. Frank with Patrick Huyghe, *The Big Splash* (New York: Carol Publishing Group, 1990). [See also related endnotes on page 104.]
 65. *“We found that there were ten times as many small comets in early November as there were in mid-January.”* Frank and Huyghe, p. 187.
 66. These arguments are effectively rebutted by Louis A. Frank and J. B. Sigwarth in “Atmospheric Holes: Instrumental and Geophysical Effects,” *Journal of Geophysical Research*, Vol. 104, No. A1, 1 January 1999, pp. 115–141.
 67. *“For unclear reasons, deep moonquakes seem largely confined to the side of the moon facing Earth.”* Elizabeth Svoboda, “New Computers Uncover Old Quakes on the Moon,” *Discover*, Vol. 27, January 2006, p. 38.
 - ◆ Seismometers left on the Moon during each Apollo landing recorded 12,500 seismic events. Then, in 1977, NASA

- turned the seismometers off. The moonquakes have now been reanalyzed using more powerful methods. Conclusion: Even after making the most adverse assumptions, most deep moonquakes were on the near side of the Moon and were clustered near the central portion of the near side. [See Yosio Nakamura, “Farside Deep Moonquakes and Deep Interior of the Moon,” *Journal of Geophysical Research*, Vol. 110, 18 January 2005, E01001.]
68. “Astronomers were stunned by the first images of the moon’s farside, captured by the Soviet spacecraft Luna 3 in 1959. The two hemispheres seemed like different worlds. The face we see [on Earth] has fewer large craters and far greater areas of smooth, dark, frozen lava. Nobody really knows why.” Bob Berman, “Worlds Out of Balance,” *Discover*, Vol. 24, December 2003, p. 38.
 - ◆ “The farside, which we cannot see from Earth but has been imaged by satellites, almost completely lacks the large basaltic plains (mare) that are so prominent on the nearside.” Maria Cruz, “The Two Faces of the Moon,” *Science*, Vol. 338, 23 November 2012, pp. 1010–1011.
 - ◆ Shadows in [Figure 175](#) accentuate craters near the day-night boundary and minimize the appearance of craters on the near side. However, lava flows (which primarily occurred on the near side) made it smoother than the far side.
 69. Mark A. Wieczarek et al., “The Crust of the Moon as Seen by GRAIL,” *Science*, Vol. 339, 8 February 2013, pp. 671–674.
 70. A uniform ball of mass M and radius R has a moment of inertia about any diameter of $0.4000 MR^2$. The Moon’s polar moment of inertia is $(0.3935 \pm 0.0011) MR^2$ —almost the same. [See J. O. Dickey et al., “Lunar Laser Ranging: A Continuing Legacy of the Apollo Program,” *Science*, Vol. 265, 22 July 1994, p. 487.] Of course, pressure and density must increase with depth. This accounts for the Moon’s moment of inertia being slightly less than that of a uniform ball. Little room is left over for a light crust. Five mascons, explained in [Figure 179 on page 320](#), account for the major discontinuities in density within the moon.
 71. “Application of gravity gradiometry to observations by the Gravity Recovery and Interior Laboratory (GRAIL) mission results in the identification of a population of linear gravity anomalies with lengths of hundreds of kilometers. Inversion of the gravity anomalies indicates elongated positive-density anomalies that are interpreted to be ancient vertical tabular intrusions or dikes formed by magmatism in combination with extension of the lithosphere ... and an increase in the Moon’s radius by 0.6 to 4.9 kilometers early in lunar history.” Jeffrey C. Andrews-Hanna et al., “Ancient Igneous Intrusions and Early Expansion of the Moon Revealed by GRAIL Gravity Gradiometry,” *Science*, Vol. 339, 8 February 2013, p. 675.
 - ◆ Had these impacts happened slowly over thousands or millions of years (instead of within a few years), the interior heat that produced this early expansion would have dissipated.
 72. Renee C. Weber et al., “Seismic Detection of the Lunar Core,” *Science*, Vol. 331, 21 January 2011, pp. 309–312.
 73. Nicholas M. Short, *Planetary Geology* (Englewood Cliffs, New Jersey: Prentice-Hall, 1975), p. 87.
 74. “In contrast, the far side [of the Moon] almost completely lacks maria.” Paul D. Spudis, “The New Moon,” *Scientific American*, Vol. 289, December 2003, p. 89.
 75. “A major surprise in the early days of lunar exploration was the discovery that the soft maria visible from earth were far more rare on the moon’s farside, presumably because of some one-sided influence of the earth. Now refinements of Mariner 9 data show one hemisphere of Mars to be far rougher than the other, and Mariner 10 suggests the same asymmetry for Mercury. Data files grow, observes Bruce Murray of the California Institute of Technology, yet so does the mystery of hemispherical asymmetry. ‘We now know,’ he says, ‘a little less about the moon.’” Jonathan Eberhart, “The Mystery of the Hemispheres,” *Science News*, Vol. 105, 13 April 1974, p. 241.
 76. Tiny beads of lunar basalt contain about 745 parts per million of water. As impacting comets and asteroids buried themselves deeply in what is now the Moon’s near side, the water-ice in those impactors mixed with the instantly created magma. Minutes or hours later, some of that magma erupted as a spray of droplets. Water molecules (and carbon, sulfur, chlorine, and fluorine) were diffusing out of the droplets as they solidified. [See Alberto E. Saal et al., “Volatile Content of Lunar Volcanic Glasses and the Presence of Water in the Moon’s Interior,” *Nature*, Vol. 454, 10 July 2008, pp. 192–194.]
 - ◆ “Several studies have found concentrations of water much higher than expected in lunar materials.” Tim Elliott, “Galvanized Lunacy,” *Nature*, Vol. 490, 18 October 2012, p. 346.
 - ◆ The D/H ratio found in apatite grains brought back by the Apollo programs matches that of comets, not Earth. [See J. P. Greenwood et al., “Water in Apollo Rock Samples and the D/H of Lunar Apatite,” *Proceedings of the 41st Lunar and Planetary Science Conference*, 2 March 2010, No. 2439.]
 - ◆ “Concentrations of hydrogen, chlorine and sulphur in the mineral apatite from 14053 [a lunar basalt rock brought back from the moon by the Apollo 14 astronauts] are indistinguishable from apatites in common terrestrial igneous rocks.” Jeremy W. Boyce et al., “Earth-Like Lunar Apatite,” *Nature*, Vol. 466, 22 July 2010, p. 411.
 77. M. Ozima et al., “Terrestrial Nitrogen and Noble Gases in Lunar Soils,” *Nature*, Vol. 436, 4 August 2005, pp. 655–659.
 78. “Oxygen isotopic compositions have been found to be identical between terrestrial and lunar samples, which is inconsistent with [the belief that the moon formed by an impact of a Mars-sized body with Earth].” Junjun Zhang et al., “The Proto-Earth as a Significant Source of Lunar Material,” *Nature Geoscience*, Vol. 5, 25 March 2012, p. 251.
 - ◆ “... the $^{50}\text{Ti}/^{47}\text{Ti}$ ratio of the Moon is identical to that of the Earth within about four parts per million, ...” Ibid.
 79. [Dust grains on Comet 67P] are generally rich in sodium, which explains the high sodium abundance in cometary meteoroids.” Rita Schulz et al., “Comet 67P/Churyumov-Gerasimenko Sheds Dust Coat Accumulated Over the Past

Four Years,” *Nature*, Vol. 518, 12 February, p. 216.

80. William R. Corliss, *Mysterious Universe: A Handbook of Astronomical Anomalies* (Glen Arm, Maryland: The Sourcebook Project, 1979), pp. 219–239.
81. “*In view of the connection of comets, meteors, and meteorites, the absence of meteorites in old deposits in the crust of the Earth is very significant. It has been estimated that at least 500 meteorites should have been found in already worked coal seams, whereas none have been identified in strata older than the Quaternary epoch (about 1-million years ago). This suggests a very recent origin [of meteors] and, by inference, of comets.*” N. T. Bobrovnikoff, “Comets,” *Astrophysics*, editor J. A. Hynek (New York: McGraw-Hill Book Co., 1951), p. 352.
82. See “**Highly Compressed Solids**” on page 608.
83. Thomas C. Van Flandern, “A Former Asteroid as the Origin of Comets,” *Icarus*, Vol. 36, October 1978, pp. 51–74.
- ◆ Tom C. Van Flandern, *Dark Matter, Missing Planets and New Comets* (Berkeley, California: North Atlantic Books, 1993), pp. 185–190.
 - ◆ Van Flandern built on earlier proposals by Olbers (1796) and Ovenden (1972) that a planetary breakup produced the asteroids. Van Flandern has altered his earlier paper in several ways. For example, the exploded planet was initially 90 Earth masses. Since then, his number of exploded planets has increased and their total mass has decreased.
84. Bode’s law—a mathematical curiosity, not a true law—was formulated by Johann Daniel Titius in 1766 but popularized by Johann Bode in 1772. Thus, it is often called the *Bode-Titius law* or the *Titius-Bode law*.

Bode’s law is a simple formula which gives the approximate distance of most planets from the Sun. While Bode’s law has no theoretical justification, it correctly predicted the existence and approximate orbital radius of Uranus (1781), but not Neptune (1846) and Pluto (1930). Also predicted is a planet 2.8 AU from the Sun, which closely corresponds to the average position of most asteroids. This led to the early belief that asteroids are the remains of an exploded planet that once orbited 2.8 AU from the Sun. [For reasons given on page 337, most experts now reject this.]

Table 19. Bode’s Law

Planet	n	Distance (AU)	
		Predicted	Actual
Mercury	−∞	0.4	0.387
Venus	0	0.7	0.723
Earth	1	1.0	1.00
Mars	2	1.6	1.52
Asteroids	3	2.8	2.78*
Jupiter	4	5.2	5.20
Saturn	5	10.0	9.54
Uranus	6	19.6	19.17
Neptune	7	38.8	30.05
Pluto	8	77.2	39.42

*Based on the 35 largest asteroids.

Bode’s formula is

$$\text{Distance (AU)} = 0.4 + 0.3 \times 2^n$$

Consider how many thousands of other equally simple formulas with arbitrary numbers (corresponding to 0.4, 0.3, 2, and the values for n) could be constructed. It should not be surprising that one of these formulas could approximate 7 of the 9 planet-Sun distances.

85. In 1668, Johannes Hevelius wrote that comets formed in the atmospheres of the giant outer planets and were flung into space by the planets’ rotation. In 1814, French mathematician Joseph Louis Lagrange proposed a more modern version of this theory. Since then, others have refined the theory, especially S. K. Vsekhsvyatsky.
- ◆ S. K. Vsekhsvyatsky, “New Evidence for the Eruptive Origin of Comets and Meteoritic Matter,” *Soviet Astronomy*, Vol. 2, No. 3, November–December 1967, pp. 473–484.
 - ◆ S. K. Vsekhsvyatsky, “The Origin and Evolution of the Comets and Other Small Bodies in the Solar System,” *The Motion, Evolution of Orbits, and Origin of Comets*, editors G. A. Chebotarev and E. I. Kazimirchak-Polonskaya (New York: Springer-Verlag, 1972), pp. 413–418.
86. J. H. Oort, “The Structure of the Cloud of Comets Surrounding the Solar System, and a Hypothesis Concerning Its Origin,” *Bulletin of the Astronomical Institutes of the Netherlands*, Vol. 11, No. 408, 13 January 1950, pp. 91–110.
87. Oort initially estimated that 10^{11} comets formed 50,000–150,000 AU away. Later, others realized that at the more distant end of that range the Sun’s gravity is so weak that passing stars, galactic clouds, and the galaxy itself would have stripped too many comets from the Oort cloud long ago. [See, for example, Julio A. Fernández, “Dynamical Aspects of the Origin of Comets,” *The Astronomical Journal*, Vol. 87, September 1982, pp. 1318–1332.] To solve this problem, more comets (10^{12} comets) are usually assumed to be in the cloud initially, and the cloud is assumed to be concentrated nearer the 50,000 AU end of that distance range. Others have proposed that at least 10^{15} comets must initially populate the Oort cloud. Oort cloud theories have many variations; only the best known are described here.
88. Jack G. Hills, “Comet Showers and the Steady-State Infall of Comets from the Oort Cloud,” *The Astronomical Journal*, Vol. 86, November 1981, pp. 1730–1740.
89. Hannes Alfven and Gustaf Arrhenius, pp. 231–238.
90. For example, billiard balls are very elastic (springlike), so collisions disperse the balls. However, if the balls were made of tar (inelastic), the balls would deform or even stick together on impact, so their paths would tend to merge.
91. R. A. Lyttleton, *The Comets and Their Origin* (Cambridge, England: At the University Press, 1953), pp. 62–110.
92. “*Although ice has been detected [in interstellar space] by its 3.1 μm absorption band, it is not nearly as abundant as expected.*” P. G. Martin, *McGraw-Hill Encyclopedia of*

Science & Technology, 6th edition (New York: McGraw-Hill Book Co., 1987), Vol. 9, p. 326.

93. *"The [Mars] lander found evidence that the chemical makeup of the dust on the surface of Mars resembles that of seawater, adding to the evidence that liquid water that once may have supported life flowed on the planet's surface."* Maggie Fox, "Mars Dust Resembles Seawater, NASA Extends Mission," Reuters News Service, 29 September 2008, www.news.yahoo.com/s/nm/20080929/sc_nm/us_mars_phoenix_1.
- ◆ *"Phoenix's instruments have also identified calcium carbonates in the soil. Carbonates are rocks that, on Earth, form mainly from calcium carbonates that precipitate out of seawater."* Ashley Yeager, "Racing Against the Martian Winter," *Science News*, www.sciencenews.org/view/generic/id/36595/title/Racing_against_the_Martian_winter, 10 October 2008.
 - ◆ *"Among the greatest surprises was the discovery ... [on Mars] of calcium carbonate (at concentrations of 5 percent) ... [Calcium carbonate] is a very common mineral on Earth. ... Others have since spotted isolated outcrops of calcium carbonate rocks although other types of carbonates seem more common."* Peter H. Smith, "Digging Mars," *Scientific American*, Vol. 305, November 2011, p. 53.
- "The Origin of Limestone"* chapter on pages 260–266 explains why most limestone originated on Earth. Most of it precipitated (out-salted) from the supercritical subterranean water and was swept upward during the flood. Indeed, the pH of Mars' limestone was *"nearly the same as ocean water on Earth."* Ibid.
- ◆ *"... we have identified a compositional unit on Mars that contains a mineralogical component likely attributable to chloride salts. We initially identified these deposits because of their spectral distinctiveness ... The deposits range in area from ~1 km² to ~25 km² [at about 200 locations] and generally are topographically lower than the immediate surrounding terrain."* M. M. Osterloo et al., "Chloride-Bearing Materials in the Southern Highlands of Mars," *Science*, Vol. 319, 21 March 2008, p. 1651.
 - ◆ *"[The Mars Rover named Opportunity, operating in what appears to be a dried-up water channel,] has uncovered soil that is more than half salt, adding to the evidence for Mars' wet past."* Guy Webster, "Mars Rovers Break Driving Records, Examine Salty Soil," *Jet Propulsion Laboratory News Release*, 2 March 2005, p. 1.
 - ◆ *"Some rocks [on Mars] may be as much as 40 percent salt, he notes. 'That's an astonishing amount' and could result only from a briny solution soaking through rock and then evaporating, leaving the salt behind, Clark says."* Benton Clark, as quoted by Ron Cowen, "Red Planet Makes a Splash," *Science News*, Vol. 165, 6 March 2004, p. 147.
 - ◆ *"... the identification of halite at the martian surface indicates extreme salinity ..."* Nicholas J. Tosca et al., "Water Activity and the Challenge for Life on Early Mars," *Science*, Vol. 320, 30 May 2008, p. 1205.
 - ◆ *"The presence of hydrated minerals on the surface of Mars implies that the crust was once altered by the action of liquid water. ... the degree of alteration of the ancient martian crust is more extensive than previously assumed."* J. Carter et al., "Detection of Hydrated Silicates in Crustal Outcrops in the Northern Plains of Mars," *Science*, Vol. 328, 25 June 2010, pp. 1610. See also pp. 1682–1686.
94. Colin M. Dundas, et al., "Exposed Subsurface ice Sheets in the Martian Mid-Latitudes," *Science*, Vol. 359, 12 January 2018, pp. 199–201.
95. Many claim that comets had to begin outside the orbit of Mars where typically (a) temperatures are cold enough for frost to condense on dust particles in space, and (b) the Sun's ultraviolet radiation is unlikely to break water molecules apart. This belief overlooks two considerations.
- First, if water vapor condensed as frost on dust particles beyond Mars, then frost should be *commonly* detected on asteroids in the asteroid belt. Frost is seldom observed. Second, icy particles orbiting beyond Mars, will not, in general, form a comet. Long periods of time increase the chances of water vapor and ice particles disintegrating.
- However, the fountains of the great deep would quickly form comets. Water molecules would not have to be brought together; they would start together. Dirt, ice, gases, and other unlikely chemicals in comets would not need to be found and mixed uniformly together; they also would start together.
96. *"Our next worry arose because the condensation of water-ice grains in interstellar clouds of low density presented severe conceptual problems. For ice crystals less than a micrometre in size to form in a pure gas, 'condensation nuclei', about which the crystals grow, must form at an adequate rate. ... Another early objection we had against the ice-grain theory was that calculations based on this model could not reproduce the way in which the fogging, or extinction, of starlight varied with wavelength: ... Secondly, attempts to find the strong absorption band at 3.1 μm due to water ice in the spectra of heavily obscured stars consistently failed."* Hoyle and Wickramasinghe, "Where Microbes Boldly Went," p. 412.
97. Zdenek Sekanina, "Detection of a Satellite Orbiting the Nucleus of Comet Hale Bopp (C/1995 O1)," First International Conference on Comet Hale Bopp, Puerto de la Cruz, Tenerife, Canary Islands, Spain, 2–5 February 1998.
98. H. D. P. Lee, *Aristotle: Meteorologica* (Cambridge, Massachusetts: Harvard University Press, 1952), p. 43.
99. Thomas H. Corcoran, *Seneca: Natural Quaestiones* (Cambridge, Massachusetts: Harvard University Press, 1972), pp. 227–299.
100. Previously, faulty logic (traceable to the time of Aristotle) went as follows: Because bodies (stars) beyond the Moon do not change their appearance, and a comet changes weekly, comets must not lie beyond the Moon.
101. M. E. Bailey et al., "The Origin of Comets," *Vistas in Astronomy*, Vol. 29, 1986, p. 61.
102. Peter Lancaster-Brown, *Halley's Comet & the Principia* (Aldeburgh, England: Aries Press, 1986), p. 17.

103. On 1 March 1665, Samuel Pepys entered in his famous diary the following statement:

At noon I [went] to dinner at Trinity House, and thence to Gresham College, where Mr. Hooke read a second very curious lecture about the late Comet; among other things proving very probably that this is the very same Comet, that appeared before in the year 1618, and that in such a time probably it will appear again, which is a very new opinion; but all will be in print. Samuel Pepys, *The Diary of Samuel Pepys*, editor Henry B. Wheatley, Vol. 4, Part 2 (New York: Crosscup & Sterling Co., 1946), p. 341.

Pepys later became the president of The Royal Society (of London), the prestigious scientific body that hosted the above lecture. The idea that some comets reappear was “a very new opinion” and deserves credit for originality. While no periodic comets were visible between 1609 and 1677, Robert Hooke may have suggested the possibility to later researchers, such as Edmond Halley. Halley’s correct prediction in 1705 of the return of the comet of 1682 (later called *Halley’s comet*) in 1758 was one of science’s classic achievements. However, Halley was criticized for making a prediction that would not be tested until after his death, “when he could no longer be embarrassed.”

104. Newton, “That the Comets Are Higher Than the Moon, and in the Regions of the Planets,” Proposition XXXIX, Lemma IV, Book III, *Principia*, pp. 399–401.
105. Fred L. Whipple, “Discovering the Nature of Comets,” *Mercury*, Vol. 15, January–February 1986, p. 5.
106. Richard A. Proctor, “Comet Families of the Giant Planets,” *Knowledge: A Monthly Record of Science*, Vol. 6, 4 July 1884, p. 5.
- ◆ Richard A. Proctor, “The Capture Theory of Comets,” *Knowledge: A Monthly Record of Science*, Vol. 6, 8 August 1884, pp. 111–112, 126–128.
107. “Thus, cometary nuclei could not have condensed in situ at distances exceeding 100 AU ... Direct condensation of the comets in situ, at the great distances of their aphelia in Oort’s sphere, is not possible.” Ernst J. Öpik, “Comets and the Formation of Planets,” *Astrophysics and Space Science*, Vol. 21, 1973, pp. 320, 394.
108. Thomas M. Donahue, “Comment on the Paper ‘On the Influx of Small Comets into the Earth’s Upper Atmosphere II. Interpretation’ by L. A. Frank et al.,” *Geophysical Research Letters*, Vol. 13, June 1986, pp. 555–557.
109. “There are at least 70,000 Trans-Neptunian Objects (TNOs) with diameters larger than 100 km in the 30-50 AU region.” Lorenzo Iorio, “Dynamical Determination of the Mass of the Kuiper Belt from Motions of the Inner Planets of the Solar System,” *Monthly Notices of the Royal Astronomical Society*, Vol. 375, 2007, p. 1311.
110. This high improbability can be shown two ways. First, the “back-of-the-envelope” method. The Marsden-Williams Comet Catalogue (Cambridge, Massachusetts: Minor Planet

Center, 1996, pp. 10–41) lists 774 different sightings of non-periodic comets. One can select two out of 774 different objects 299,151 ways, or $\binom{774}{2}$. Five numbers (i , q , e , ω , and Ω) specify an ellipse in space. Let’s say that the chance that two randomly-selected comet sightings have “similar” values for the combination q and e is 0.25—at least as similar as those of the “strange pairs.” Two angles (Ω and ω) have values ranging from 0 to 360 degrees and a third angle, i , ranges between 0 and 180 degrees. If each comet sighting in a “strange pair” had values for i , Ω , and ω within five degrees on either side of the corresponding angles of the other comet, one might expect about three “strange pairs” simply due to chance—nine less than the twelve actually observed.

$$299,151 \times \left[0.25 \times \left(\frac{5 \times 2}{360} \right)^2 \left(\frac{5 \times 2}{180} \right) \right] \approx 3$$

111. My computer simulations of the solar system during its last 350 years have shown that Herschel-Rigollet did not come near enough to any planet for that gravity boost. Therefore, its gravity boost probably came from mass beyond 30 AU.

A more accurate approach involves a computer simulation. By examining the 30 recorded consecutive orbits of Halley’s comet, one can see that planetary perturbations change certain orbital elements less than others. (For example, i —the angle of inclination—changes very little from orbit to orbit.) Therefore, changes in each orbital element must be weighted properly when comparing two different orbits.

Next, for all 774 comet sightings, I swapped each true orbital element with the corresponding orbital element of a randomly chosen comet. Then, a count was made of how many of the 299,151 random pairings were as similar as the “strange pairs.” Typically, there were three. In other words, chance can explain about three of the twelve “strange pairs” shown on [page 316](#). That leaves about ten other pairs—or ten comets that were seen on two consecutive orbits.

This is surprising, because the estimated periods for both members of each pair are too large for them to be the same comet. However, these comets spend most of their time far beyond the planets. Some very slight force, accelerating the comets for centuries, could greatly shorten their periods.

112. The Great Comet of 1680 was also blamed for the Biblical deluge. In 1694, Edmond Halley suggested that the global flood may have been due “to an Earth-comet encounter.”

Two years later, Isaac Newton’s successor in the Lucasian professorship at Cambridge, William Whiston (1667–1752), published a book, *A New History of the Earth*, stating that “on Friday, November 28, 2349 B.C., the Great Comet of 1680 passed very close to the Earth. The near collision caused a tidal breakup of the Earth’s crust. The subsequent release of subterranean waters, together with precipitation from the comet’s atmosphere and tail, caused the Biblical deluge by raising a tide several miles high.” [See Yeomans, p. 164.]

William Whiston is also famous for his popular translation (1732) from Greek of *The Complete Works of Flavius Josephus*. Josephus was the Jewish-Roman historian and Jewish military

leader of Galilee who witnessed the Roman destruction of Jerusalem in A.D. 70. Josephus' voluminous writings have given us detailed secular insights into the lives of the Jewish people in the centuries before the sacking of Jerusalem.

113. K. J. Meech, and O. R. Hainaut, "HST Imaging of Distant Comet Nuclei," *Bulletin of the American Astronomical Society*, Vol. 29, July 1997, p. 1021.
114. P. M. Muller and W. L. Sjogren, "Mascons: Lunar Mass Concentrations," *Science*, Vol. 161, 16 August 1968, pp. 680–684.
115. Richard A. F. Grieve, "The Record of Impact on Earth," *Geological Society of America*, Special Paper 190, 1982, pp. 25–37.
116. The energy required just to "disperse" a planet of uniform density, mass M , and radius R can be shown to be

$$\frac{3}{5} \frac{GM^2}{R}$$

where G is the gravitational constant. If the planet's density is greater in its core, as it is for all planets, the energy requirement increases. "Disperse" here means to accelerate each of the planet's particles to its escape velocity.

117. Bill Napier and R. J. Dodd, "The Missing Planet," *Nature*, Vol. 242, 23 March 1973, pp. 250–251.

A planet could explode if it contained enough fissionable material that suddenly became a critical mass. However, as Anders notes, "*such an explosion 6 million years ago [or less] would have left large amounts of long-lived radioactivity, such as ^{10}Be and ^{53}Mn , on the Earth, Moon, and meteorites.*" These isotopes have not been detected. [See E. Anders, Discussions of "A Former Major Planet of the Solar System," *Comets, Asteroids, Meteorites*, editor A. H. Delsemme (Toledo, Ohio: The University of Toledo, 1977), p. 479.]

118. Jupiter generates tidal friction inside Io, which produces Io's heat. [See Ron Cowen, "Close Encounter: Galileo Eyes Io," *Science News*, Vol. 156, 11 December 1999, pp. 382–383.]
119. S. K. Vsekhsvyatsky, "Comets and the Cosmogony of the Solar System," *Comets, Asteroids, Meteorites*, editor A. H. Delsemme (Toledo, Ohio: The University of Toledo, 1977), p. 470.
120. Ariel A. Roth, "Some Questions about Geochronology," *Origins*, Vol. 13, No. 2, 1986, p. 75.
121. Marsden and Sekanina, "On the Distribution of 'Original' Orbits of Comets of Large Perihelion Distance," *The Astronomical Journal*, Vol. 78, December 1973, p. 1123.
122. Fernández, pp. 1318, 1324.
123. Paul R. Weissman, "The Oort Cloud and the Galaxy: Dynamical Interactions," *The Galaxy and the Solar System*, editors Roman Smoluchowski et al. (Tucson, Arizona: The University of Arizona Press, 1986), p. 212.
124. Some researchers have suspected that one of two stars, Algol or Gliese 710, may have recently disturbed an Oort cloud. Actual measurements dispute this. "*The new figures reveal that neither star comes close enough to shake up the Oort Cloud and generate a comet shower.*" Ron Cowen, "Dino Death: A Stellar Weapon," *Science News*, Vol. 153, 31 January 1998, p. 79.

- ◆ Jeffrey Winters, "A Brief Tour of a Bad Cosmic Neighborhood," *Discover*, Vol. 19, April 1998, p. 56.
125. "*Any Oort cloud formed with the Sun and planets 4.5 billion years ago would by now have been devastated ...*" Victor Clube and Bill Napier, "Close Encounters with a Million Comets," *New Scientist*, 15 July 1982, p. 149.
126. Julio A. Fernández, "The Formation of the Oort Cloud and the Primitive Galactic Environment," *Icarus*, Vol. 129, September 1997, pp. 106–119.
- ◆ Everhart, p. 329.
127. Fernández, "Dynamical Aspects of the Origin of Comets," p. 1318.
128. Any giant planet would expend much of its orbital energy in flinging 10,000 Earth masses of comets out toward an Oort cloud. Also, the gravity-assisted boosts needed to give so many comets their angular momentum would shrink the planet's orbit, requiring it to have begun much farther from the Sun.
- While this might help solve one aspect of the comet origin problem, it creates problems for the few astronomers trying to figure out how the giant planets evolved. These astronomers wonder how the giant planets could form where they are *now*, even if billions of years were available. That problem worsens for objects trying to form farther from the Sun, where matter is more spread out and moving even more slowly. [See Öpik, pp. 307–398. Also see Richard Greenberg, "The Origin of Comets Among the Accreting Outer Planets," *Dynamics of Comets: Their Origin and Evolution*, editors Andrea Carusi and Giovanni B. Valsecchi (Boston: D. Reidel Publishing Co., 1985), pp. 3–10.]
129. S. Alan Stern and Paul R. Weissman, "Rapid Collisional Evolution of Comets during the Formation of the Oort Cloud," *Nature*, Vol. 409, 1 February 2001, pp. 589–591.
130. "*No wastage would occur with Uranus or Neptune, but then the ejection time scale, 10^{11} yr, is prohibitive.*" Öpik, p. 395.
131. Gerard P. Kuiper, "On the Origin of the Solar System," *Astrophysics*, editor J. A. Hynek (New York: McGraw-Hill Book Co., 1951), pp. 357–424.
132. Ron Cowen, "Second Look Finds No Comet Reservoir," *Science News*, Vol. 149, 22 June 1996, p. 395.
133. Weissman, p. 210.
134. John F. Kerridge and James F. Vedder, "An Experimental Approach to Circumsolar Accretion," *Symposium on the Origin of the Solar System* (Paris, France: Centre National de la Recherche Scientifique, 1972), pp. 282–283.
135. Martin Harwit, *Astrophysical Concepts* (New York: John Wiley & Sons, 1973), pp. 394–395.
136. Thomas S. Kuhn, *The Structure of Scientific Revolutions* (Chicago: The University of Chicago Press, 1970). [Both the National Review and the Modern Library (a division of Random House) listed this book among the hundred best nonfiction books written in English during the 20th century.]



Figure 180: Asteroid Ida and Its Moon, Dactyl. In 1993, the Galileo spacecraft, heading toward Jupiter, took this picture 2,000 miles from asteroid Ida. To the surprise of most, Ida had a moon (about 1 mile in diameter) orbiting 60 miles away! Both Ida and Dactyl are composed of earthlike rock. We now know that at least 243 other asteroids have moons; ten of them have two moons.¹ According to the laws of orbital mechanics (described in the preceding chapter), capturing a moon in space is unbelievably difficult—unless both the asteroid and a nearby potential moon had very similar speeds and directions, and unless gases, which can provide aerobraking, surrounded the asteroid, so the potential moon could be slowed down enough to be captured. If so, the asteroid, its moon, and each gas molecule were probably coming from the same place and launched about the same time. Within a million years, passing bodies would have stripped the moons away, so these asteroid-moon captures must have been relatively recent.

From a distance, an asteroid looks like a big rock. However, many show, by their low density, that they contain something light, such as water-ice or empty space.² Also, the best close-up pictures of an asteroid show millions of smaller rocks on its surface. *Can you guess why many are well rounded?* Asteroids are literally *flying rock piles* held together by gravity. Ida, about 35 miles long, does not have enough gravity to squeeze itself into a spherical shape.

The Origin of Asteroids, Meteoroids, and Trans-Neptunian Objects

SUMMARY: *The fountains of the great deep launched rocks and muddy water into space. As rocks moved farther from Earth, Earth's gravity became less significant to them, and the gravity of nearby rocks became increasingly significant. Consequently, many rocks, assisted by their mutual gravity and surrounding clouds of water vapor that produced aerobraking, merged to become asteroids. (Isolated rocks in space are meteoroids.) Drag forces caused by water vapor and thrust forces produced by the radiometer effect concentrated most smaller asteroids in what is now the asteroid belt. Larger asteroids were acted on longer by more powerful forces which pushed them out beyond Neptune's orbit. All the so-called "mavericks of the solar system" (asteroids, meteoroids, comets, and trans-Neptunian objects) resulted from the explosive events as the flood began.*

Asteroids, also called *minor planets*, are rocky bodies orbiting the Sun. Ninety percent of them have orbits between the orbits of Mars and Jupiter, a region called *the asteroid belt*. The largest asteroid, Ceres, is almost 600 miles in diameter and has about one-third the volume of all other asteroids combined. Precise orbital details are known for some 625,000 asteroids.³ Some that cross Earth's orbit might do great damage if they ever collided with Earth.

Textbooks give two explanations for the origin of asteroids: (1) they are the remains of an exploded planet, and (2) a planet failed to evolve completely. Experts recognize the problems with each explanation and are puzzled. The hydroplate theory offers a simple and complete—but quite different—solution that also answers other questions.

Exploded-Planet Explanation. Smaller asteroids are more numerous than larger asteroids, a pattern typical of fragmented bodies. Seeing this pattern led to the early belief that asteroids are the remains of an exploded planet. Later, scientists realized that all asteroids combined would not form one small planet.⁴ Besides, too much energy is needed to explode and scatter even the smallest planet. [See Item 21 on page 320.]

Meteorites, Meteors, and Meteoroids

In space, drifting rocks smaller than 10 meters but larger than a molecule are called "meteoroids." They are renamed "meteors" as they travel through Earth's atmosphere, and "meteorites" if they hit the ground.

Failed-Planet Explanation. The most popular explanation today for asteroids is that they are bodies that did not merge to become a planet. Never explained is how, in nearly empty space, matter merged to become these rocky bodies in the first place,⁵ why rocky bodies started to form a planet but stopped,⁶ or why it happened primarily between the orbits of Mars and Jupiter. Also, because only vague explanations have been given for how planets formed, any claim to understand how one planet failed to form lacks credibility. [See Items 43–46 on pages 27–29.] Orbiting rocks do not merge to become planets or asteroids unless special conditions are present, which the hydroplate theory provides. [See page 312 and Endnote 18 on page 326.] Today, collisions fragment and scatter asteroids, just the opposite of this "failed-planet explanation." During the 4,600,000,000 years evolutionists say asteroids have existed, asteroids would have had so many collisions that they should be much more fragmented than they are today.⁷

Hydroplate Explanation. The fountains of the great deep launched rocks and water from Earth.⁸ Water droplets launched into space partially evaporated and quickly froze. Large rocks had large gravitational spheres of influence which grew as the rocks traveled away from Earth. The largest rocks became "seeds" around which ice particles, smaller rocks, and gas molecules collected gravitationally. Aerobraking by that gas, collapsed much of the mass around those "seed rocks," forming asteroids. [See page 303.]

The size distribution of asteroids shows that at least part of a planet fragmented, but no known energy source is available to explode and disperse *an entire* Earth-size

planet. [See item 21 on page 320.] However, the eruption of so much supercritical water (explained on page 126) from the subterranean chambers could have launched a small percent of the Earth. Astronomers have tried to describe the exploded planet, not realizing they were standing on the remaining $97 \pm 1\%$ of it—too close to see it.

As flood waters escaped from the subterranean chambers, pillars were crushed, because they were forced to carry more and more of the weight of the overlying crust. Also, the almost 60-mile-high walls of the rupture were unstable, because rock is not strong enough to support a cliff more than 5 miles high. As lower portions of the walls crumbled, blocks—some a staggering 200 meters in diameter—were swept up and launched by the jetting fountains. [See Figure 181.] Unsupported rock in the top 5 miles then fragmented. The smaller the rock, the faster it accelerated and the farther it went, just as a rapidly flowing stream carries smaller dirt particles faster and farther.

PREDICTION 39: Asteroids are rock piles, often with internal ice acting as a weak glue.⁹ Large rocks that began the capture process are near the centers of asteroids and comets.



Four years after this prediction was published in 2001 (In the Beginning, 7th edition, page 220), measurements of the largest asteroid, Ceres, found that it does indeed have a dense, rocky core and a mantle primarily of water-ice.¹⁰

On 23 January 2014, it was announced that two jets of water vapor were discovered escaping from Ceres at a combined rate of 13 pounds per second.

PREDICTION 40: Most of the rocks (pebble-size and larger) comprising asteroids and comets will be found to be rounded to some degree. (This rounding occurred as the rocks tumbled and were eroded in the powerful fountains of the great deep, just as rocks are tumbled and rounded in fast flowing streams.)



The European Space Administration announced on 18 December 2014 that very large, rounded boulders—1 to 3 meters in diameter—are stacked “layer upon layer” “all over” Comet 67P. [See Figure 184 on page 340.] They jokingly call them dinosaur eggs, and believe they could be the basic building blocks that clumped together to form” comets.¹¹

Question 1: Why did some clumps of rocks and ice in space become asteroids and others become comets?

Imagine living in a part of the world where heavy frost settled each night, but the Sun shone daily. After many decades, would the countryside be buried in hundreds of feet of frost?

The answer depends on several things besides the obvious need for a large source of water. If dark rocks initially covered the ground, the Sun would heat them during the

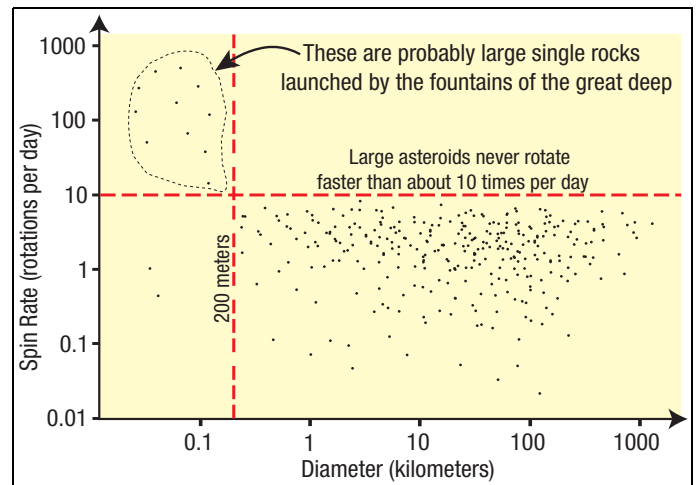

Figure 181: Rapidly Spinning Asteroids. Clumps of rocks in space, held together by only their weak mutual gravity, will fly apart if they spin faster than ten times a day. Asteroids larger than 200 meters across never spin faster than ten times a day, so those bodies may be clusters of loose rocks. Asteroids smaller than 200 meters often spin hundreds of times a day. Therefore, they must be solid rocks.¹²

How could solid rocks drifting in space have formed? Had they formed from dust or pebble-size grains, impacts by other particles would have scattered the merged, but weakly-held particles. Consequently, these bodies must be fragments of a much larger body, such as a planet.

But that raises another question. If part of a planet fragmented, or if an entire planet exploded, how could the fragments gravitationally escape? They would have to be accelerated to that planet’s escape velocity. As has already been explained in many ways, Earth’s subcrustal ocean burst forth as the fountains of the great deep and launched those very large rocks.

As explained in the comet chapter, the fountains of the great deep reached speeds of 32 miles per second, enough to accelerate 200-meter-diameter rocks up to and beyond 7 miles per second—Earth’s escape velocity. That high-velocity flow also tumbled and rounded each rock. [See predictions 40 and 41.]



PREDICTION 41: Asteroids spinning faster than ten rotations per day will be found to be single, well-rounded rocks.

day, so frost settling on them during the night would evaporate. However, if the sunlight was dim or the frost was thick (so it reflected more sunlight during the day), little frost would evaporate. More frost would accumulate each night.

Now imagine living on a newly formed asteroid. Its spin would give you day-night cycles. Asteroids do not have enough gravity to hold an atmosphere for long. With little atmosphere for the Sun to warm, day temperatures at the asteroid’s surface would rise rapidly. At night, the day’s heat would quickly radiate, unimpeded, into outer space.

As the fountains of the great deep launched rocks and water droplets, evaporation in space dispersed an “ocean” of water molecules and other gases into the inner solar system. Gas molecules that struck the cold side of your spinning asteroid would become frost.¹³ Sunlight would usually be

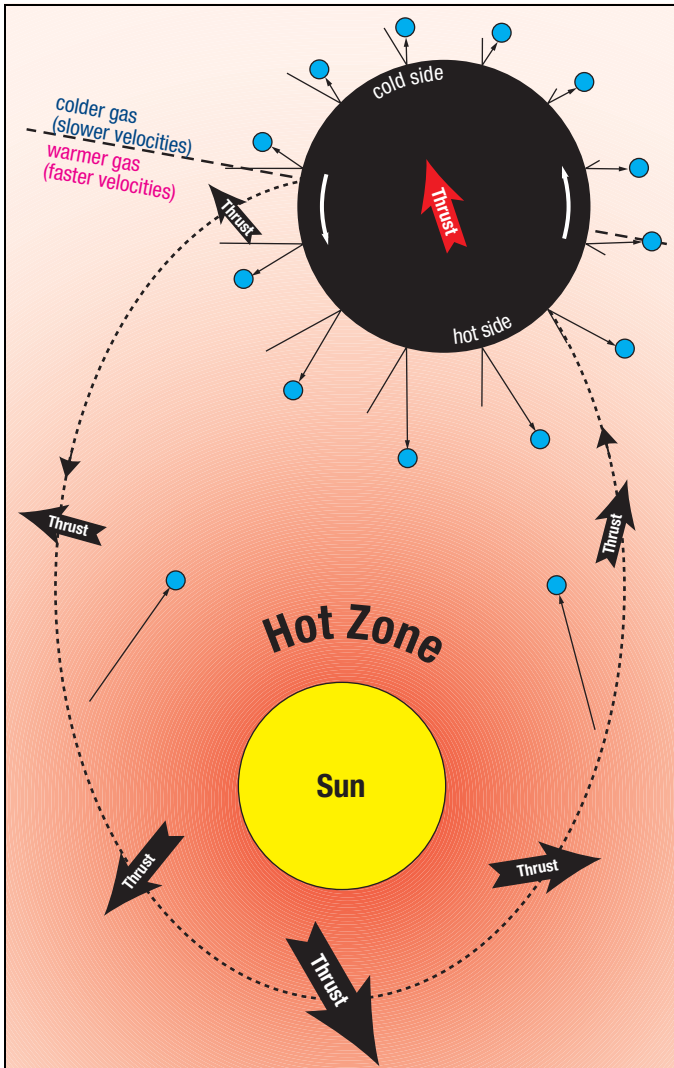

Figure 182: Thrust and Drag Acted on Asteroids. Sun, asteroid (large black circle), gas molecules (small blue circles), and orbit are not to scale. The fountains of the great deep launched rocks and muddy water from Earth. The larger rocks, assisted by water vapor and other gases within the spheres of influence of these rocks, captured other rocks and ice particles. Those growing bodies that were primarily rocks became asteroids.

The Sun heats an asteroid's near side, while the far side radiates its heat into cold outer space. Therefore, large temperature differences exist on opposite sides of each rocky, orbiting body. The darker the body¹⁴ and the slower it spins, the greater that temperature difference. (For example, temperatures on the sunny side of our Moon reach a searing 240°F, while on the dark side, temperatures can drop to a frigid -270°F) Also, gas molecules between the Sun and asteroid, *especially those coming from very near the Sun*, are hotter and faster than those on the far side of an asteroid. Hot gas molecules hitting the hot side of an asteroid bounce off with much higher energy and momentum than cold gas molecules bouncing off the cold side. Those impacts slowly expanded asteroid orbits until too little gas remained in the inner solar system to provide much thrust. The closer an asteroid was to the Sun, the greater the outward thrust. Gas molecules, concentrated near Earth's orbit for years after the flood, created a drag on asteroids. My computer simulations show that this gas could slowly move asteroids from many random orbits into the asteroid belt.¹⁵ Thrust primarily expanded the orbits. Drag circularized orbits and reduced their angles of inclination.

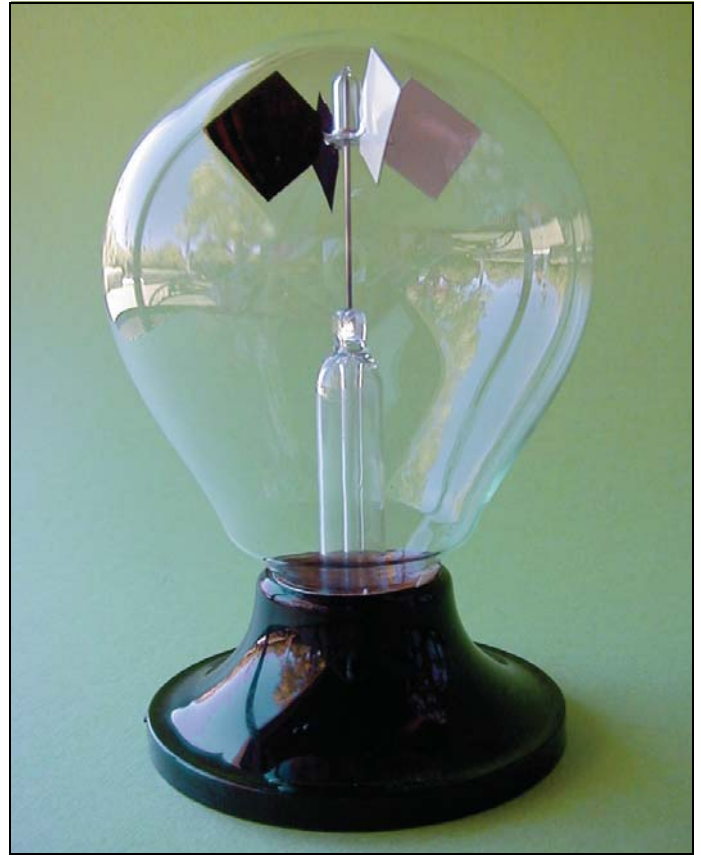

Figure 183: The Radiometer Effect. This well-known novelty, called a *radiometer*, demonstrates the unusual thrust that pushed asteroids into their present orbits. Sunlight warms the dark side of each vane more than the light side. A partial vacuum exists inside the bulb, so gas molecules travel relatively long distances before striking other molecules. On average, gas molecules bounce off the hotter, black side with greater velocity and momentum than off the colder, white side. This turns the vanes away from the dark side.¹⁶

The black side also radiates heat faster when it is warmer than its surroundings. This can be demonstrated by briefly placing the radiometer in a freezer. There, the black side cools faster, making the white side warmer than the black, so the vanes turn away from the white side. In summary, the black side gains heat faster when in a hot environment and loses heat faster when in a cold environment. Movement is always away from the warmer side.

The physics of the radiometer effect was not correctly understood for 50 years following Sir William Crookes' demonstration of the effect in 1873. Even the famous James Clerk Maxwell failed to understand the effect when he reviewed and approved Crookes' paper for publication. Osborne Reynolds (of "Reynolds-number" fame) and Albert Einstein correctly explained key aspects of the effect in 1876 and 1924, respectively.¹⁶

The thrust on the radiometer acts primarily on the vane's hot edges, not the vane's relatively large area. The swarms of tiny rocks and ice orbiting the Sun during and after the flood had an astronomical number of hot edges, so the total thrust on each swarm was greater than on a regular radiometer.¹⁷

dim on rocks in larger, more elongated orbits. Therefore, little frost would evaporate during the day, and the frost's thickness would increase. Your "world" would become a comet. However, if your "world" orbited relatively near

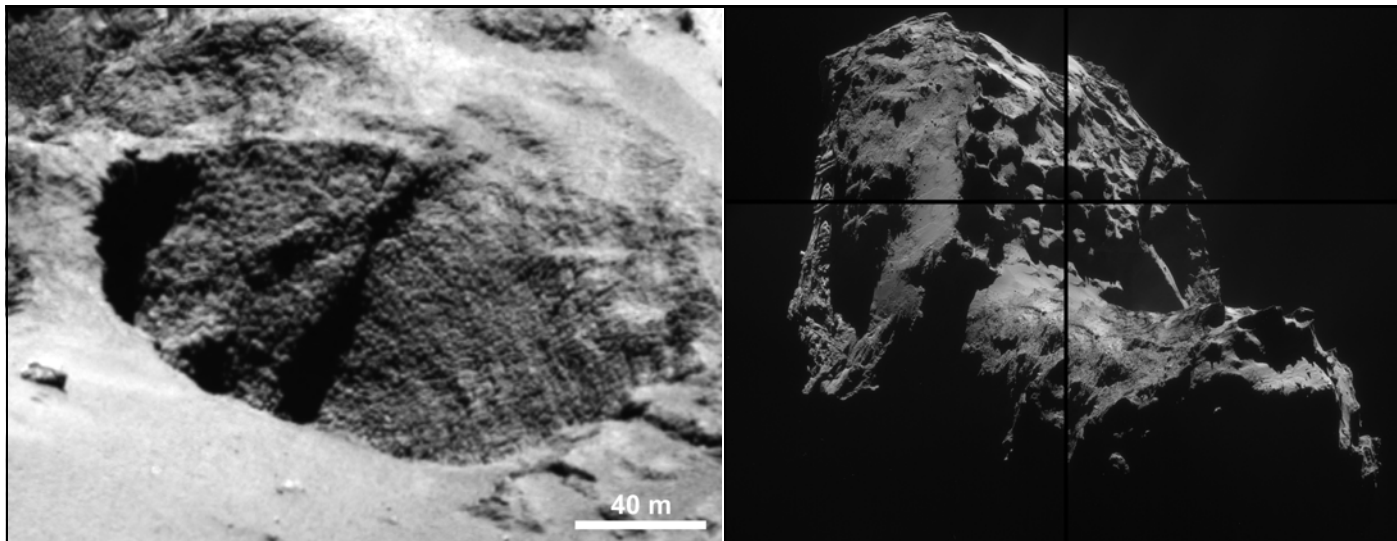

Figure 184: “Dinosaur Eggs.” These photographs, taken by the Rosetta spacecraft, show two portions of Comet 67P/Churyumov–Gerasimenko. Left: Layer upon layer of rounded boulders (nicknamed “Dinosaur Eggs” or “Goosebumps”) are exposed in the walls of craters “all over the comet.”¹¹ These spheres, 10 feet (3 meters) in diameter, sometimes fall out of vertical cliffs and collect at the base of the cliffs without crumbling. Therefore, the spheres are hard, solid rocks, not compacted dust or pebbles. In the right picture (at the black cross), you are seeing a cliff on a small part of the comet. Notice the spherical impressions made by spheres that fell out of the cliff. (Credits: ESA/Rosetta/MPS for OSIRIS Team MPS/UPD/LAM/IAA/SSO/INTA/UPM/DASP/IDA)

At the beginning of the flood, the 46,000-mile-long rupture that wrapped around the Earth formed two cliffs, each 60-miles high. Rock at the base of the cliffs, no longer compressed on all sides, crumbled, because the weight of the overlying rock exceeded granite’s crushing strength. That, in turn, removed support for the overlying rock at the top of the cliffs, so it collapsed, and the rupture’s width steadily grew. That debris was then swept up and out by the escaping subterranean water—the fountains of the great deep, which had speeds of up to 32 miles per second. The launched rocks—those smaller than 650 feet (200 meters) in diameter—were tumbled, eroded, *and rounded* as they accelerated upward and exceeded Earth’s escape velocity of 7 miles per second. Later, gravity and aerobraking (primarily with water vapor) gently merged those rounded rocks, along with water and dirt, into comets and asteroids.

Scientists at the European Space Agency (ESA) admit that they do not know how these spheres formed.¹⁸ Comet researchers and others will continue to be perplexed until they understand the power of the fountains of the great deep. Of course, that requires understanding the flood—especially the source of the water and the indescribable amount of energy that was released. In the next chapter, “The Origin of Earth’s Radioactivity,” you will see how that energy was produced. You will also see why one must first understand the origin of Earth’s radioactivity before considering the Earth’s age. Earth’s radioactivity was a consequence of the flood and has nothing to do with the age of the Earth. [See “**Why Do We Have Radioactivity on Earth?**” on page 122.]

Those who refuse to consider the global flood, can use another scientific approach. Instead of reasoning from cause to effect, as we have done, they could reason from effect back to its likely cause. In other words, they could look carefully at these pictures and ask what must have happened to explain their puzzling details. First, what rounded those huge rocks? Fast flowing rivers tumble and round rocks, but that takes many years, even for the fastest rivers. There are no rivers on comets, and the rounded rocks on comet 67P are 10 feet in diameter, not little cobbles or river rocks you can hold in your hand. So, we need something flowing very fast. Besides, any liquid on a comet would immediately flash into vapor or freeze. The only flow in the near vacuum of space that could round rocks would be a hypervelocity gas or plasma. Second, what formed so many rocks of similar size before they were rounded? Solid rocks in space that big don’t assemble from smaller particles, because an impact by another small particle would scatter the particles that had already merged; impacts in space are usually at high velocities. Therefore, something much larger (such as part of a moon or planet) may have been crushed before the rocks were rounded, since crushing produces somewhat uniform fragments. Then, the erosion and rounding process produces great uniformity, because the larger rocks, slower to accelerate and tumble, are eroded more by the hypervelocity fountains. When two very strange things happen at about the same time, such as (1) a hypervelocity flow that accelerates and rounds gigantic rocks, and (2) the crushing of part of a moon or planet, usually they are connected.

the Sun, its rays would evaporate each night’s frost, so your “world” would remain an asteroid.

In general, heavier rocks could not be launched with as much velocity as smaller particles (dirt, water droplets, and smaller rocks). The heavier rocks merged to become asteroids, while smaller particles, primarily water, merged to become comets, which usually have larger orbits. No “sharp line” separates asteroids and comets. In fact, some comets are also asteroids and some asteroids are also comets.¹⁹

It should not be surprising that asteroids and comets have so many similarities, because both formed by similar processes from rocks and water launched by the fountains of the great deep, as the flood began.

Question 2: Wasn’t asteroid Eros found to be primarily a large, solid rock?

A pile of dry sand here on Earth cannot maintain a slope greater than about 30 degrees. If it were steeper, the sand grains would roll downhill. Likewise, a pile of dry pebbles



Figure 185: Hot Meteorites. Most iron-nickel meteorites display Widmanstätten patterns. That is, if an iron-nickel meteorite is cut and its face is polished and then etched with acid, the surface has the strange crisscross pattern shown above. This shows that temperatures throughout those meteorites exceeded 1,300°F.²⁰ Why were so many meteoroids, drifting in cold space, at one time so uniformly hot?

Heating during an impact would be so brief that thermal conduction (a very slow process) could not produce the extremely uniform Widmanstätten patterns, nor would a blowtorch. The brief heating a meteor experiences in passing through the atmosphere is barely felt more than a fraction of an inch beneath the surface. Such iron meteorites had to have been “soaked” in an environment that was at least 1,300°F for a very long time before it entered cold outer space. If radioactive decay generated the heat, certain daughter products should be present, but are not. Question 5 explains how these high temperatures were reached.

or rocks on an asteroid cannot have a slope exceeding about 30 degrees.²¹ However, 4% of Eros’ surface exceeds this slope, so some scientists mistakenly concluded that much of Eros was a large, *solid* rock. This conclusion overlooked the ice in asteroids that acts as a weak glue—as stated in Prediction 39 above. Ice in asteroids also explains their low density. Figure 181 gives another reason asteroids are probably flying rock piles.

Question 3: Objects launched from Earth should travel in elliptical, cometlike orbits. How could rocky bodies launched from Earth become concentrated in almost circular orbits between Mars and Jupiter?

Gases, such as water vapor and its components,²² were abundant in the inner solar system for years after the flood. Hot gas molecules striking each asteroid’s hot side were repelled with great force. This jetting action was like air rapidly escaping from a balloon, applying a thrust in a direction opposite to the escaping gas.²³ Cold molecules striking each asteroid’s cold side produced less jetting. This type of thrusting, which I call *the radiometer effect*, was *efficiently powered by solar energy* and spiraled asteroids outward, away from the Sun, concentrating them between the orbits of Mars and Jupiter. [See Figures 182 and 183.]

Question 4: Could the radiometer effect push asteroids 1–2 astronomical units (AU) farther from the Sun?

Each asteroid began as a swarm of particles (rocks, ice, and gas molecules) orbiting within a large sphere of influence—much like a swarm of bees hovering around a beehive. The swarm’s volume was quite large, so its spin was much



Figure 186: Shatter Cones. When a large, crater-forming meteorite strikes the Earth, a shock wave radiates outward from the impact point. The passing shock wave often breaks rock surrounding the crater into meteorite-size fragments having distinctive patterns called *shatter cones*. (Until shatter cones were associated with impact craters by Robert S. Dietz in 1969, impact craters were often difficult to identify.)

If large impacts on asteroids launched asteroid fragments toward Earth as meteorites, a few meteorites should have shatter cone patterns. None have ever been reported. Therefore, *meteorites are probably not derived from asteroids*. Likewise, impacts have not launched meteorites from Mars. [For other reasons, see page 353.]

slower than it would be once aerobraking collapsed the swarm into a single asteroid. The slow spin produced extreme temperature differences between the hot and cold sides. The cold side would have been so cold that water molecules striking it would tend to stick as frost, thereby *adding* “fuel” to the developing asteroid. When the swarm rotated 180°, that frost evaporated, adding pressure, and therefore thrust, to the hot side. This cycle (freezing followed by evaporating and thrusting) was probably repeated thousands of times, especially in larger swarms.

Because the swarm’s volume was large, the radiometer pressure acted over a large area and produced a large thrust. The swarm’s large thrust and low density caused the swarm to rapidly accelerate—much as a feather placed in a steady breeze. Also, the Sun’s gravity 93,000,000 miles from the Sun (the Earth–Sun distance) is 1,600 times weaker than Earth’s gravity here on Earth.²⁴ So, pushing a swarm of rocks and debris farther from the Sun was surprisingly easy, because there is almost no resistance in outer space.

Question 5: Why are 4% of meteorites almost entirely iron and nickel? Also, why do meteorites rarely contain quartz, which constitutes about 27% of granite’s volume?

Pillarlike structures formed in the subterranean chamber when the thicker, denser portions of the crust settled through the subterranean water onto the chamber floor. [Pages 469–475 describe pillars and how, why, when, and where they formed.] Twice daily, during the centuries before the flood,

tides in the subterranean water stretched and compressed these pillars. This powerful heating process steadily raised pillar and subterranean water temperatures, dissolved quartz, and made pillars porous (spongelike). Figure 185 explains why these temperatures exceeded 1,300°F, enough to do all this and allow iron and nickel to settle downward and concentrate in the pillar tips.²⁵ Gravitational settling also concentrated iron and nickel in the Earth's core after the flood began. [See **"Melting the Inner Earth"** on pages 603–606.]

Evolutionists have difficulty explaining iron-nickel meteorites. First, everyone recognizes that a powerful heating mechanism must first melt some of the parent body from which the iron-nickel meteorites came, so iron and nickel can sink and be concentrated. How this could have occurred in extremely cold asteroids drifting in outer space has defied explanation.²⁶ Second, the concentrated iron and nickel, which evolutionists visualize in the core of a large asteroid, must then be excavated and blasted into space. The evidence shows this has not happened.²⁷

Question 6: Aren't meteoroids chips off asteroids?

This commonly-taught idea is based on an error in logic. Asteroids and meteoroids have some similarities, but that does not mean that one came from the other. Maybe a common event produced both asteroids and meteoroids.

Also, four major discoveries suggest that meteoroids came not from asteroids, but from Earth.

1. By 1975, the Pioneer 10 and 11 spacecraft traveled out through the asteroid belt. NASA expected that the particle detection experiments on board would find 10 times more micrometeoroids in the belt than are present near Earth's orbit.²⁸ Surprisingly, the number of micrometeoroids diminished as the asteroid belt was approached,²⁹ showing that micrometeoroids are not coming from asteroids but from nearer the Earth's orbit. [See Figure 193 on page 349.]
2. A faint glow of light, called *zodiacal light*, extends from the orbit of Venus out to the asteroid belt. The light is reflected sunlight bouncing off dust-size particles. This lens-shaped swarm of particles orbits the Sun, near Earth's orbital plane. On dark, moonless nights, zodiacal light can be seen best in the spring in the western sky after sunset and in the fall in the eastern sky before sunrise. Debris chipped off asteroids would have a wide range of sizes and would not be as uniform and fine as the particles reflecting the zodiacal light. The fine dust particles expelled by the fountains of the great deep would lie near Earth's orbital plane, provide the faint uniform glow, and better explain zodiacal light.
3. Many meteorites have remanent magnetism, so they must have come from a larger magnetized body. Eros, the only asteroid on which a spacecraft has landed and

Two Interpretations

With a transmission electron microscope, Japanese scientist Kazushige Tomeoka identified several major events in the life of one meteorite, which initially was part of a much larger parent body orbiting the Sun. The parent body had many thin cracks, through which mineral-rich water cycled. Extremely thin mineral layers were deposited on the walls of these cracks. These deposits, sometimes hundreds of layers thick, contained calcium, magnesium, carbonates, and other chemicals. Mild thermal metamorphism in this rock shows that temperatures increased before it experienced some final cracks and was blasted into space.³⁰

Hydroplate Interpretation. Earth was the parent body of all meteorites, most of which are pillar fragments. [Pages 469–475 describes pillars and how, why, when, and where pillars formed.] In the centuries before the flood, tides in the subterranean water compressed and stretched these pillars twice a day. This tidal pumping heated and cracked pillars. Just as water circulates within a submerged sponge that is squeezed and stretched, tidal pumping circulated mineral-laden water within cracks in pillars. When the flood began, the fountains of the great deep launched pillar fragments, into space; they became meteoroids. [**"The Origin of Limestone"** chapter on pages 260–266 explains the presence of calcium, magnesium, and carbonates in the water.] In summary, *water did it*.

Tomeoka's (and Most Evolutionists') Interpretation. Impacts on an asteroid cracked the rock that was to become this meteorite. Ice was deposited on the asteroid. Impacts melted the ice, allowing liquid water to circulate through the cracks and deposit hundreds of layers of magnesium, calcium, and carbonate bearing minerals. A final impact blasted rocks from this asteroid into space. In summary, *impacts did it*.

taken magnetic measurements (as of 2018), has no net magnetic field. If this is true of other asteroids as well, meteorites probably did not come from asteroids.³¹ If asteroids are flying rock piles, as it now appears, any magnetic fields in the randomly oriented rocks would be largely self-canceling, so the asteroid would have no net magnetic field. Therefore, instead of coming from asteroids, meteorites likely came from a magnetized body, such as a planet. Because Earth's magnetic field is 2,000 times greater than that of all other rocky planets combined, meteorites probably came from Earth.

Some believe that meteorites were chipped off asteroids millions of years ago. Actually, remanent magnetism decays, so meteorites must have *recently* broken away from their parent magnetized body.



PREDICTION 42: Most rocks comprising asteroids will be found to be magnetized.

4. Meteorites can be divided into three classes: 95% are stones, 4% are irons, and 1% are in an intermediate class, stoney irons—more correctly called *pallasites*. (Pallasites were discovered in 1794 by German naturalist Peter Simon Pallas.) Stones are rich in the chemical element silicon and the mineral olivine.³² Irons are an iron-nickel mixture that was initially molten. Pallasites formed from a molten iron-nickel mixture injected into or mixed with fragments, primarily of olivine. We know the iron and nickel were molten, because smelting is required to extract and concentrate iron and nickel from the ores or rocks containing those elements.

Once in a dense, liquid state, the iron-nickel drained downward along cracks. Later, it cooled and solidified as one unit—separately encasing millions of olivine crystals. (Figure 187 explains this in more detail.)

What provided the heat that melted so much iron and nickel? It is commonly taught that Earth evolved as rocks fell from outer space onto an asteroid-size body that steadily grew over millions of years into today's Earth. Those impacts supposedly heated the growing Earth so much it became molten, allowing iron and nickel to gravitationally settle to form Earth's core. [The many reasons this is not true are explained in “**Forming the Core**” on page 160.] This common error led to the view that meteorites also impacted and melted large asteroids, so they too formed liquid cores. That is doubtful, because powerful impacts could shatter asteroids (which are just flying rock piles). Also, asteroids are so much smaller than Earth that they rarely receive impacts and they lose heat faster than Earth. (Smaller bodies have a higher surface-to-volume ratio, so they radiate their heat faster into outer space.) This is why asteroids, since their formation, have been cold, and never molten.

Earth's mantle is rich in silicon and olivine, and Earth's core is iron-nickel rich, so pallasites were thought to have come from some core-mantle boundary. Earth was never considered as the parent body for any meteorites, let alone pallasites, because few could have imagined, in their wildest dreams, an energy source that could have launched large rocks at speeds greater than Earth's escape velocity: 7.0 miles per second (11.2 km/sec).³³ Besides, wouldn't iron meteorites have had to come from Earth's iron-nickel outer core, 1,800–3,200 miles below Earth's surface? Therefore, everyone reasoned—incorrectly, it turns out—that meteorites came from much smaller bodies. Asteroids, with a (hoped for) iron-nickel core, seemed to fit the bill, but



Figure 187: Pallasites. Think how surprised you would be if you saw water frozen in a tank with thousands of ping-pong balls evenly distributed throughout the ice. That would be strange enough, but when sunlight shines through those ping-pong balls, they glow. Pallasites are just as surprising.

This 22-pound pallasite meteorite is a thin slice of the larger, 925-pound Fukang meteorite that fell in 2000 in the Gobi Desert in China's Xinjiang Province. Sunlight from behind, shining through the olivine crystals, makes them glow—like Sun shining through a stained-glass window. Each translucent piece of gem-quality olivine is suspended in a gray, iron-nickel metal that was molten when the olivine grains were encased. This presents a problem. Olivine's density is about 3.7 grams/cubic centimeter, while the density of iron-nickel is about 7.8 grams/cubic centimeter—more than twice as dense. Why didn't the low-density olivine float to the top of the dense iron-nickel liquid?

Obviously, no gravity was acting to separate these particles as the molten iron-nickel froze. Zero gravity means the meteorite, containing molten iron and nickel, was drifting weightlessly in outer space as the freezing occurred. Then why was the less dense olivine scattered within the dense molten iron-nickel? The meteorite was tumbling as it was launched. Similar events have previously been described in this book:

*Early during the flood, fluttering hydroplates and pounding pillars crushed rock and slid rock fragments over each other. Friction at those extreme pressures melted the sliding surfaces and injected the denser iron-nickel liquid into cracks below. Many large rocks were swept up by the escaping (extremely hot) supercritical water and launched into outer space by the fountains of the great deep. Then, as the fountains expanded upward, the temperature of the flow dropped to nearly absolute zero (-460°F)—as explained in “**Rocket Science**” on pages 581–582. The molten iron-nickel (mixed with what are now gem-quality olivine crystals) quickly froze.*

Why is the olivine gem-quality and, therefore, so bright? The suspended crystals merged (grew in size) as the iron-nickel solidified in the weightless environment of space—precisely the conditions in which crystals can grow most uniformly and become gem-quality. Thus, light can shine through each of the olivine crystals with minimal distortion, as shown above.

even then, *excavating and launching* iron meteorites from an asteroid large enough to possibly have a solid, iron-nickel core was still difficult to imagine.²⁷

But pallasites present five other problems:

- ◆ Since iron-nickel liquid is twice as dense as olivine, how could olivine fragments be scattered throughout molten iron and nickel? All the low-density olivine should float to the top. [See Figure 187.]
- ◆ The boundary between a silicon-rich mantle and molten iron-nickel core should be extremely thin, even if such a boundary existed in an asteroid. The number of pallasites that could come from that thin boundary would be far less than the 1:4 ratio of pallasites to iron meteorites.
- ◆ Tests on eight pallasites showed that the molten iron-nickel mixtures cooled at such diverse rates that they could not have originated at a core-mantle boundary, even in an asteroid.³⁴ Cooling rates at such a boundary would have been quite uniform. However, cooling rates inside rocks launched into extremely cold space would differ considerably, because of the different sizes of the rocks.
- ◆ Some pallasites contain remanent magnetism, showing that the molten metal cooled in the presence of various magnetic fields, some were up to twice as strong as Earth's field today.³⁵ (There is no *direct evidence* that any asteroid ever had a magnetic field, although many believe that story.) In the next chapter, you will see that the fluttering hydroplates and pounding pillars produced a steady stream of powerful electrical surges within the crust and pillars. Magnetic fields accompanied each of the billions of electrical surges.
- ◆ Probably no asteroid is big enough to have ever had a molten core, let alone a magnetic field. Yes, 90% of all meteorites show evidence of at least some melting, but that is because they came from the hot subterranean chamber, not from an asteroid in supercold space. Many hypotheses have been proposed to try to solve this long-standing problem: "What heated the asteroids?"³⁶ No clean answer exists, because the heating occurred before the asteroids formed.³⁷

The hydroplate theory solves all five problems.

Twenty-six additional observations either (1) support the proposed explanation that meteoroids and the material that formed asteroids came from Earth, or (2) are inconsistent with current theories on the origin of asteroids and meteoroids.

1. For decades, astronomers have said that asteroids are rocky bodies and comets are dirty snowballs.³⁸ Why then do at least some asteroids have water-ice on and inside them?³⁹ [See Prediction 40 and Figure 192 on page 349.] If ice or water vapor came out from inside

an asteroid, how did the water get inside? Certainly, not from outside, because almost all asteroids are too close to the Sun for water (liquid or ice) to remain?⁴⁰ [See "Earth: The Water Planet" on page 27.]

Answer: Some water and complex organic matter that were formerly on the Earth are now in asteroids and comets. [See "Rosetta Mission" on pages 309.] No "sharp line" separates asteroids and comets.

The hydroplate theory provides the details. As the flood began, muddy water and some organic material were launched from Earth. In the cold vacuum of space, about half of that water quickly evaporated and the remainder froze. Later, gravity (as explained beginning on page 312) formed asteroids and comets from some of that material. Since the flood, almost all ice on asteroid surfaces has sublimated (vaporized), leaving behind a crust of dirt that protects the deeper ice within. If internal ice is suddenly exposed by an impact or by fracturing, water vapor will briefly vent and form a temporary atmosphere for the asteroid. Eventually, that water vapor will either escape or become frost on the asteroid's surface. Water-ice has been discovered on asteroids Themis and Cybele.³⁹



PREDICTION 43: Water-ice on asteroids will be rich in deuterium.



PREDICTION 44: A deep, penetrating impact on a large asteroid, such as Ceres, will release huge volumes of water vapor. (This prediction has now been confirmed.⁹ See Figure 188.)

2. Minerals in meteorites are remarkably similar to those in the Earth's crust.⁴¹ Some meteorites contain very dense elements, such as nickel and iron. Those heavy elements seem compatible only with the dense, rocky planets: Mercury, Venus, Mars, and Earth—Earth being the densest.

A few asteroid densities have been calculated. They are generally low, ranging from 1.2 to 3.3 gm/cm³. The higher densities match those of the Earth's crust. The lower densities imply the presence of empty space between loosely held rocks. One asteroid is too massive to be porous inside, so it must contain a very rigid, low-density substance, such as water-ice.⁴²



PREDICTION 45: Rocks in asteroids are typical of the Earth's crust. Expensive efforts to mine asteroids⁴³ to recover strategic or precious metals will be a waste of money.

3. Most meteorites⁴⁴ contain metamorphosed minerals, showing that they reached extremely high temperatures and pressures, despite a supposed lifetime in the "deep freeze" and weightlessness of outer space.

Asteroids have also experienced extreme heating.³⁷ Radioactive decay within such small bodies could not have produced the necessary heating, because too much heat would have escaped from their surfaces. Stranger still, liquid water altered some meteorites⁴⁵ while they and their parent bodies were heated—sometimes multiple times.⁴⁶

Impacts in space are often proposed to explain this mysterious heating throughout an asteroid or meteorite. However, an impact—similar to throwing a baseball into a bean-bag chair—would raise the temperature only for an instant near the point of impact. Before gravel-size fragments from an impact could become uniformly hot, they would radiate their heat into outer space.⁴⁷

For centuries before the flood, tidal pumping generated considerable heat within pillars in the subterranean water chamber. [See Question 5 on page 341.] As the flood began, the powerful fountains of the deep launched rock fragments into space—fragments of hot, crushed pillars and rocks from the crumbling walls of the ruptured crust. Those rocks became meteoroids and asteroids.

4. Diamonds, the hardest of all minerals, have been found in meteorites,⁴⁸ showing that at one time both temperatures and pressures within those rocks were extremely high.⁴⁹ Asteroid impacts in supercold space (almost absolute zero) might produce the pressures needed, but would not produce the necessary temperatures. Meteorites entering Earth's atmosphere are heated but only on their surface, and their tumbling action would probably not produce the necessary pressure. Both the compression event and pounding pillars, described in detail by the hydroplate theory, would each produce the temperatures and pressures needed to form diamonds. Besides, diamonds are a solid form of pure carbon. Pure, solid carbon is extremely rare in outer space, but common on Earth. (Vegetation doesn't grow in outer space.)
5. Because the material that later merged to become asteroids came from Earth, asteroids typically spin in the same direction as Earth—counterclockwise, as seen from the North. However, collisions have undoubtedly randomized the spins of many smaller asteroids in the last few thousand years.⁵⁰
6. Some asteroids have captured one or more moons. [See Figure 180.] Sometimes the “moon” and asteroid are similar in size. Impacts would not create equal-size fragments that could capture each other.⁵¹ The only conceivable way for this to happen is if a potential moon enters an asteroid's expanding sphere of influence while traveling about the same speed and direction as the asteroid. If even a thin gas surrounds

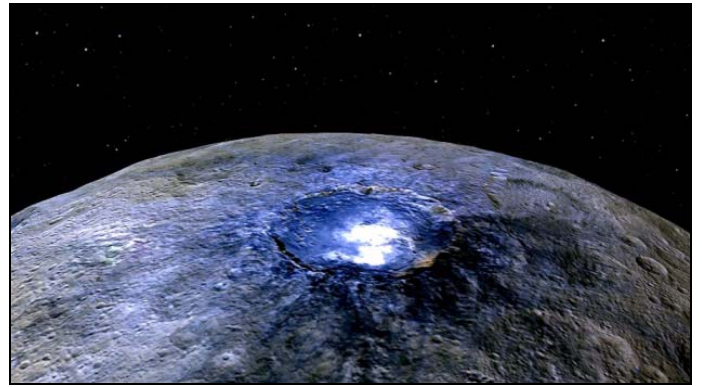

Figure 188: Bright Spots on Ceres. In March 2015, NASA's Dawn spacecraft began orbiting Ceres, the largest of all asteroids (almost 600 miles in diameter). In the next few months, scientists discovered 130 bright spots on Ceres which, after months of debate, were identified as salt⁵² and water ice, usually in the bottom of craters. When sunlight warms the largest and brightest spot (shown above in a 2.5 mile deep crater), the ice, whose melting temperature is lowered by the salt, sublimates into a low cloud of water vapor that reflects even more sunlight. The cloud appears and disappears in step with the day-night cycle. Most water vapor remains below the high crater rim, although a few kilograms of this water escape from Ceres each second. Therefore, this crater is young.⁵³

The hydroplate theory, pages 111–151, explains how the salt was concentrated in the subterranean water chamber and transported to Ceres. How did ice and its dissolved salts collect in the bottom of craters? Within a few years (or perhaps centuries) after the flood, aerobraking collapsed each swarm of rocks, ice, and dirt, releasing heat and forming the solar system's asteroids and comets. When Ceres, the most massive asteroid formed, such great heat was released that considerable internal ice melted, causing liquid water to rise and collect under the frozen surface of Ceres. Later impacts on Ceres produced craters that exposed the ice below or collected water that melted from the impact, drained into the crater, and froze. (Water ice is 25% of Ceres by weight.)

the asteroid, the moon will be drawn closer to the asteroid, preventing the moon from being stripped away later. An “exploded planet” would disperse relatively little gas. The “failed planet explanation” meets none of the requirements. The hydroplate theory satisfies all requirements.

Also, tidal effects, described on pages 576–580, limit the lifetime of the moons of asteroids to about 100,000 years.⁵⁴ This fact and the problems in capturing a moon caused evolutionist astronomers to scoff at early reports that some asteroids have moons.

7. Meteorites contain different isotopes of the chemical element molybdenum, each isotope having a slightly different atomic weight. If, as evolutionists teach, a swirling cloud of gas and dust mixed for millions of years and produced the Sun, its planets, and meteorites, then each meteorite should have about the same combination of these molybdenum isotopes. Because this is not the case,⁵⁵ meteorites did not come from a swirling dust cloud or any source that mixed for millions of years.

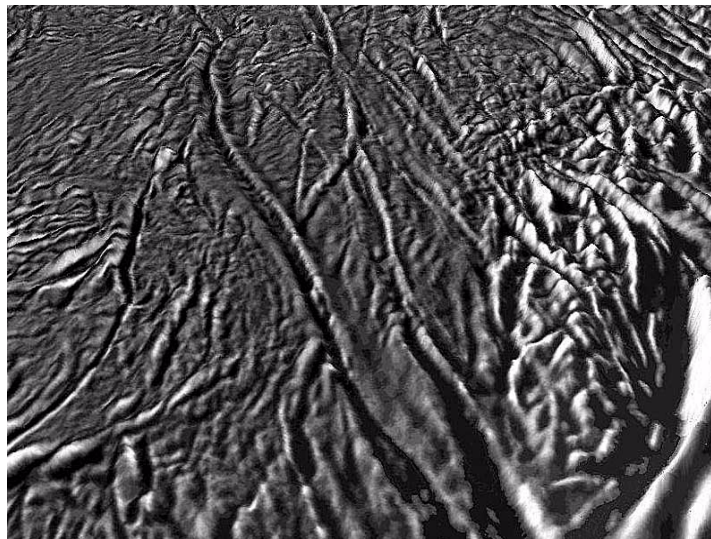
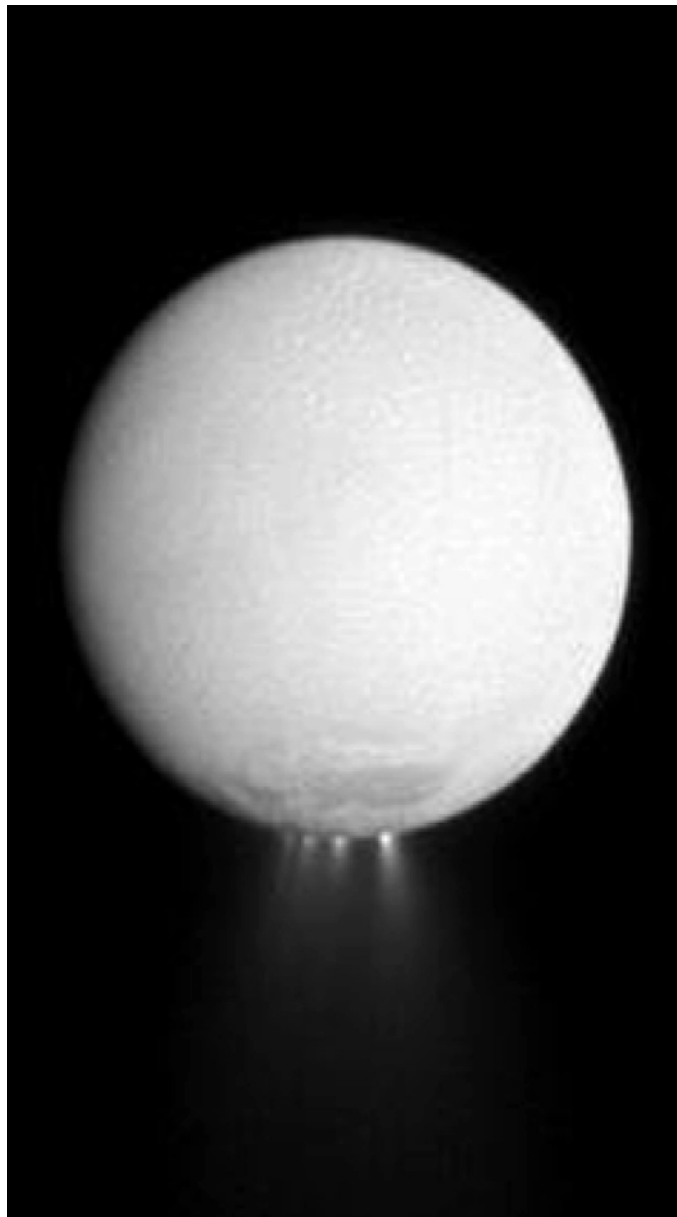

Figure 189: Enceladus, One of Saturn’s Moons. (Left) Fountains of salty water (in the form of a hot plasma and micrometer-sized ice crystals) are steadily ejecting from Enceladus’ south pole. *The concentration of salts is similar to that in Earth’s oceans.*⁵⁷ Can you guess why? Water that fails to escape Enceladus falls back as snow—similar to water that fell back from the fountains of the great deep onto Earth during the global flood. Also, tidal pumping by Saturn’s gravity produces the great heat that converts Enceladus’ subsurface water-ice into electrically charged plasma jets—just as tidal pumping (from the Sun’s and Moon’s gravity) heated the pre-flood subterranean water. This jetting and heating must have begun recently.⁵⁸ The fountains on Enceladus also contain “water vapor laced with small amounts of methane as well as simple and complex organic molecules. Surprisingly, the plumes of Enceladus are similar in make-up to many comets.”⁵⁹ Again, can you guess why?

(Top) A close-up photo of Enceladus’ south pole shows what NASA calls “tiger stripes,” where 80-mile-long curtains of water erupt up through cracks in the ice crust. (Those jets are not visible under the lighting conditions of this picture.) Tidal pumping widens and narrows the cracks⁵⁸ and causes them to slip laterally, showing that an ocean lies below the entire crust.⁶⁰ As water is expelled from under the south pole, the icy crust wrinkles, like the skin of a dried out, shriveled orange. Most wrinkles are 500–1,000 feet high; some are 1,600 feet high.

(The next chapter, “**The Origin of Earth’s Radioactivity**,” will explain why different mixes of isotopes are in different meteorites, but for now remember that most meteorites are fragments of crushed pillars and each pillar was subjected to a different isotope-producing environment when the flood began.)

8. The smaller moons of the giant planets (Jupiter, Saturn, Uranus, and Neptune) are captured asteroids. Astronomers generally accept this conclusion, but do not know how these captures could have occurred.⁵⁶

As explained earlier in this chapter, the radiometer effect, *powered by the immense energy of the Sun*, spiraled asteroids outward from Earth’s orbit for decades after the flood. Water vapor tended to collect as thick envelopes (temporary atmospheres) around asteroids and planets, causing aerobraking which

allowed massive planets to capture asteroids. Without these temporary atmospheres (or some yet to be explained means for removing orbital energy), capture is nearly impossible.⁶¹

Saturn’s 313-mile-wide moon, Enceladus (en-SELL-uh-duhs), is an asteroid, captured by aerobraking, and is therefore in a highly elliptical orbit. [See Figure 189.] Asteroids are icy and weak, so those captured by a giant planet experience strong tides. Tidal pumping at Enceladus slowed its spin, and generated considerable internal heat that melted ice and boiled deep reservoirs of water. Because this capture was quite recent,⁵⁸ the water jetting from cold Enceladus is still a hot plasma. “Dark green organic material”⁶² is on its surface, and the Cassini spacecraft measured “*concentrated and complex macromolecular organic material with molecular masses above 200 atomic mass units.*”⁶³

Because those molecules are so large and complex, they are probably from life that was on Earth before the flood. The water escaping Enceladus supplies Saturn's E ring,⁶⁴ and contains salts resembling those in Earth's ocean waters.⁵⁷ This loss of internal water has buckled the surface near the geysers as shown in Figure 189.

The farther Enceladus is (on its elliptical orbit) from Saturn, the more Enceladus' crust is stretched at its south pole and the more water vapor and ice particles are ejected. Tidal stresses widen and narrow the fractures that connect the tiger stripes to the Lake-Superior-size global "ocean" below Enceladus' crust.⁵⁸

But some researchers object.⁶⁵ They say that heat generated by tidal pumping could not "keep a global [subsurface] ocean from freezing,"⁶⁶ let alone melt ice in the first place. What is overlooked is that tidal pumping and internal heating were greatest immediately after asteroid Enceladus was captured as a moon only about 5,000 years ago. Since then, its spin rate has slowed, and frictional heating has diminished. [To understand tidal heating using an example closer to home, see "Tidal Pumping" on page 126 and pages 595–596.]

9. Saturn's moon, Dione, has a subsurface, liquid-water, global ocean, heated by tidal pumping and estimated to be under 100 kilometers of water ice.⁶⁷ Therefore, as explained above, it is also a recently captured asteroid.
10. Mars has two tiny moons, Phobos (FOH-bus), 14 miles in diameter, and Deimos (DEE-mus), 8 miles in diameter. In 2008, a spacecraft passing near Phobos measured its density (1.876 gm/cm³); Phobos contains up to 30% empty space⁶⁸ or something much lighter than rock, such as water-ice. Asteroids and Phobos have similar low densities. Both moons have similar surface materials as asteroids,⁶⁹ but different surface materials than Mars. Therefore, Phobos and Deimos probably were not blasted off Mars, but instead are captured asteroids.⁷⁰



PREDICTION 46: Mars' smaller moon, Deimos, also will be found to have a very low density.

Outgassing

In 1988, the Russian spacecraft, Phobos-2, detected outgassing on Mars' two moons, Phobos and Deimos.⁷¹ This is similar to the outgassing by Enceladus (shown in Figure 189) and by black smokers on Earth's ocean floors. [See Figure 56 on page 125.] Clearly, all this outgassing must have begun recently, not millions of years ago.

Astronomers would normally conclude that both moons are captured asteroids, except for the inconvenient laws of orbital mechanics which show it is virtually impossible to perturb asteroids from circular orbits in the asteroid belt and place them in circular orbits around Mars. Astronomers are perplexed.

However, asteroids did not come from the asteroid belt; they formed from rocks and water (ice) launched from Earth by the powerful fountains of the great deep. Then, the radiometer effect, powered by solar energy, spiraled asteroids out through Mars' orbit. Water from asteroids and comets impacting Mars gave Mars a temporarily thick atmosphere able to capture asteroids by aerobraking. Similar events account for the more than 180 moons around the giant planets.

This scenario on Mars is largely confirmed by the fact that *both of its moons have circular orbits that lie in Mars' equatorial plane.*⁷² Why? In the years following the flood, Mars' atmosphere had a very low density but grew temporarily to be thousands of miles thick.⁷³ This facilitated asteroid capture and transferred enough angular momentum from Mars' rotation to circularized Phobos and Deimos and align them in Mars' equatorial plane.

Similar captures of outward spiraling asteroids occurred farther out, placing moons with circular orbits in the equatorial planes of the giant planets.⁷² Because asteroids did not spiral inward, Venus and Mercury acquired no asteroids as moons.

11. Many asteroids, called *active asteroids*,⁷⁴ suddenly develop comet tails, so they are considered both asteroid and comet. The hydroplate theory says that asteroids are weakly joined piles of rocks and ice. If such a pile cracked slightly, perhaps due to an impact by space debris, then internal ice, suddenly exposed to the vacuum of space, would violently vent (sublimate) water vapor and produce a comet tail. The hydroplate theory explains why comets are so similar to asteroids.
12. A few comets have nearly circular orbits within the asteroid belt. Their tails lengthen as they approach perihelion and recede as they approach aphelion. If comets formed beyond Neptune, it is highly improbable that they could end up in nearly circular orbits in the asteroid belt.⁷⁵ So, these comets almost certainly did not form in the outer solar system. The hydroplate theory explains how comets (icy rock piles) recently entered the asteroid belt.
13. If asteroids passing near Earth came from the asteroid belt, too many of them have circular orbits,⁷⁶ and diameters less than 50 meters.⁷⁷ However, we would expect this if the rocks that formed asteroids were launched from Earth.

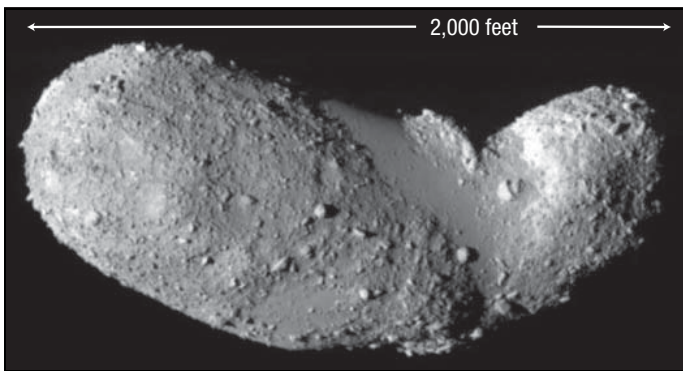

Figure 190: Asteroid Itokawa (E-toe-KA-wah). The fountains expelled dirt, rocks, and considerable water from Earth. About half of that water quickly evaporated into the vacuum of space, freezing the remainder. Each evaporated gas molecule became an orbiting body in the solar system. Later, as explained on pages 337–344, asteroids and comets formed—many shaped like peanuts.⁷⁸

Gas molecules captured by asteroids or released by icy asteroids became their temporary atmospheres. Asteroids with thick atmospheres sometimes captured (by aerobraking) smaller asteroids as moons. If an atmosphere remained long enough, those moons would lose altitude and *gently* merge gravitationally with their asteroids, forming peanut-shaped asteroids. If an atmosphere dissipates before merging, a moon remains, as shown in Figure 180 on page 336. We see merging (called *aerobraking*) when a satellite or spacecraft reenters Earth's atmosphere, slowly loses altitude, and falls to (merges with) Earth. Without an atmosphere, merging in space becomes almost impossible.

Itokawa formed from two smaller asteroids with different densities ($1,750 \text{ kg/m}^3$ and $2,850 \text{ kg/m}^3$) that merged after each accumulated its layered sediments.⁷⁹ Donald Yeomans, a member of NASA's Jet Propulsion Laboratory, admitted, *It's a major mystery how two objects each the size of skyscrapers could collide without blowing each other to smithereens. This is especially puzzling in a region of the solar system where gravitational forces would normally involve collision speeds of 2 km/sec [4,500 miles per hour].*⁸⁰

The mystery is solved when one understands that water vapor and aerobraking in weightless outer space gently merged the material in comets and asteroids.

Comet 67P, described in the “**Rosetta Mission**” on page 309, also has a peanut shape, but is described as looking like a “rubber duckie”: two rounded bodies that merged—the smaller duck's head sitting midway on its potato-shaped body. For over a year scientists were mystified for the reasons Donald Yeomans explained above. Therefore, they proposed an explanation that most people would consider crazy: maybe something in the vacuum of space eroded only the narrow neck region where the two lobes joined. Although the scientists finally saw enough evidence that showed the two bodies merged,⁸¹ they are still mystified for the reason Yeomans gave, but all of you know why the merging by aerobraking was gentle. [See p. 309.]

As explained in Prediction 40 on page 338, notice on Itokawa's surface the many *rounded boulders*, some 150 feet in diameter. An exploded planet or impacts on asteroids would produce angular rocks. Japan's Hayabusa spacecraft traveled alongside asteroid Itokawa for two months in 2005. The spacecraft landed on asteroid Itokawa, scooped up 1534 tiny rocks (up to 0.18 millimeters in diameter) and returned them to Earth in 2010. The wide range of minerals in those rocks were typical of Earth's most common minerals, but their chemical elements were quite different from the solar system's most common chemical elements. Analyses of Itokawa's minerals show that at some time in the distant past, they reached temperatures of up to 1472°F , which would have been typical of the rocks in the subterranean chambers. Average temperatures on the asteroid itself are $1,900^\circ\text{F}$ colder!⁸²

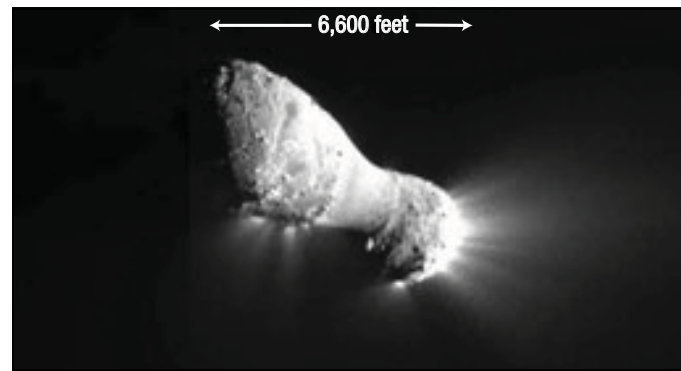

Figure 191: Comet Hartley 2. On 4 November 2010, the Deep Impact spacecraft passed within 435 miles of Comet Hartley 2 and took this photograph. Hartley 2 has a peanut shape, as does asteroid Itokawa (shown in Figure 190) and some other asteroids and comet nuclei, because they all formed by the same special mechanism.

Once launched into space by the fountains of the great deep, smaller debris gravitationally merged with large rocks traveling nearby with similar velocities and directions. The velocities of merging pairs were similar, because they were launched about the same time and place and with similar directions and speeds. Smaller bodies that came within the spheres of influence of larger rocks briefly orbited the larger bodies. Then, if the gas in those spheres of influence (gas also launched into the inner solar system) removed enough orbital energy, the larger body captured the smaller body. Once captured, aerobraking decayed the orbits and, over weeks to years, the two gently merged.

Eventually, the larger rocks gravitationally attracted enough matter (swarms of ice, dust, gases, and *organic material*) that they became large globs. The larger a glob became, the larger its sphere of influence, so the glob could pull in even more material. Finally, if two large globs gently merged, they became peanut-shaped comets or asteroids. [See Figures 190 and 191.]

If merged bodies have spent much of their lives orbiting close to the Sun, their frozen surface volatiles would have completely evaporated; we call them asteroids. However, if the merged bodies spent little time near the Sun, their volatiles would still be venting today when they passed near the Sun, and we call them comets. This is why asteroids and comets have so many similarities, why a few are catalogued as both comet and asteroid, and why asteroids impacted by space debris will suddenly start venting their frozen internal volatiles.

What was the source of the organic material? Probably it came from something living, although that is not absolutely necessary. Further space missions will clarify this. If it turns out that it came from life, one would be wise to bet that *the life came from the pre-flood Earth, not that life originated in outer space*. The latter is absurd, because life is so complex, and organisms exposed to space radiations for millions of years would be dead.

Surprisingly, Hartley 2 is expelling more carbon dioxide (CO_2) than water vapor. Undoubtedly, other comets and asteroids once contained frozen CO_2 (dry ice). Because Hartley 2, a small comet, is still sublimating, it must be *very young*. To understand all of this, see “**Why Do Comets have so Much Carbon Dioxide?**” on page 308.

- Computer simulations, both forward and backward in time, show that asteroids traveling near Earth have a maximum expected lifetime of only about a million years. They “quickly” collide with the Sun.⁸³ This raises

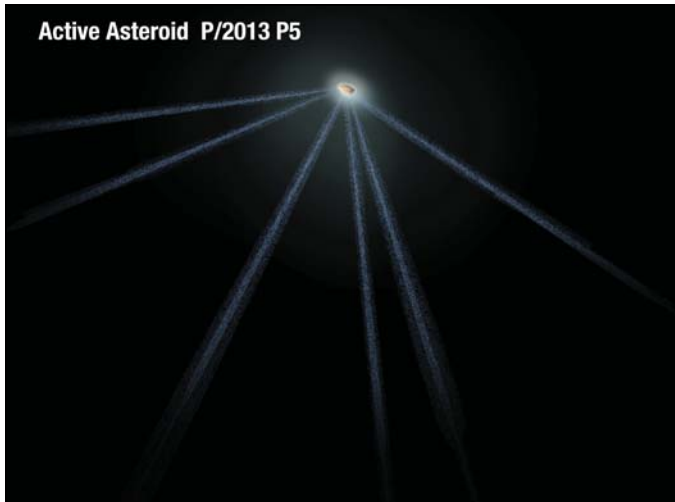

Figure 192: Six Tails. “We were literally dumbfounded when we saw [this 1,600-foot-diameter asteroid],” said lead investigator David C. Jewitt, who viewed this asteroid with the Hubble Space Telescope. “It was hard to believe we’re looking at an asteroid.”⁸⁴ For at least 5 months, it looked like a rotating lawn sprinkler. “Because nothing like this has ever been seen before, astronomers are scratching their heads to find an adequate explanation for its out-of-this-world appearance.”⁸⁴

Why should we be surprised? The fountains of the great deep launched water, rocks, and dirt. Later, the gravity of each very large rock, drifting weightlessly in space, pulled in smaller nearby rocks, water-ice, and dirt in the large rock’s sphere of influence. (Aerobraking by all the water vapor then accomplished the merging.) Therefore, asteroids are flying rock piles held together by gravity *and ice acting as a weak glue*.

An external impact or shift within an asteroid would open hairline cracks exposing some of its internal ice to the vacuum of space. The ice would begin to generate water vapor (sublimate). At the base of such cracks deep inside the asteroid, pressures would suddenly increase and resemble a jet aircraft’s combustion chamber, except an asteroid’s jets would be hundreds of tons of water vapor and entrained dust, not burning aviation fuel.

Jewitt and other astronomers recognized that internal ice would explain what their eyes were clearly telling them, but how could water get inside an asteroid? In the vacuum of space, water (liquid or ice) closer to the Sun than 5 AU vaporizes and is blown out of the solar system by solar wind.⁴⁰ This asteroid is only 2.2 AU from the Sun. Besides, how could ice in asteroids stick around for billions of years. It should have escaped by now.⁷ Jewitt mistakenly concludes:

*[The asteroid] is an unlikely carrier of water ice, and sublimation is unlikely to account for the observed activity ... While some [asteroids] are suspected to contain water ice whose sublimation is responsible for the expulsion of dust, others [asteroids] are impact-produced while, for a majority, the origin [of the ice] is unknown.*⁸⁵

Yes, about half of every water droplet in the fountains flashed into steam, but that evaporative cooling quickly froze the remaining liquid. When the ice crystals, vapor, rock, and dust mixture in a large rock’s sphere of influence eventually merged to form an asteroid, the ice was already inside. All of this began during the flood, only about 5,000 years ago. Problem solved.

This asteroid is in the asteroid belt. Comets, on the other hand, have elongated orbits and come in much closer to the Sun. As a comet heats up near its perihelion, it develops many jets. [See Figure 169 on page 303.] Because comets vent near the Sun, a strong solar wind acts on a comet’s jets and pushes them away from the Sun as a unit—forming a comet’s tail.

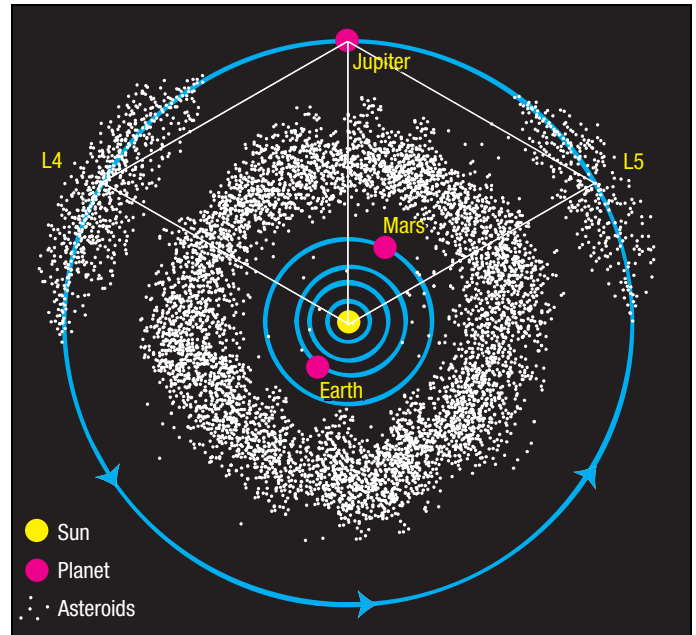

Figure 193: Asteroid Belt and Jupiter’s L4 and L5. The size of the Sun, planets, and especially asteroids are magnified, but their relative positions are accurate. About 90% of the 732,884 catalogued asteroids lie between the orbits of Mars and Jupiter, a doughnut-shaped region called *the asteroid belt*. A few small asteroids cross Earth’s orbit.

Jupiter’s Lagrange points, L4 and L5, lie 60° ahead and 60° behind Jupiter, respectively. They move about the Sun at the same velocity as Jupiter, as if they were fixed at the corners of the two equilateral triangles shown. Items 16 and 17 explain why so many asteroids—called *Trojan asteroids*—have settled near L4 and L5, and why significantly more oscillate around L4 than L5.

doubts that all asteroids began 4,600,000,000 years ago as evolutionists claim—living 4,600 times longer than the expected lifetime of near-Earth asteroids.

15. Earth has one big moon and several tiny moons—up to 650 feet in diameter.⁸⁶ The easiest explanation for the small moons is that they were launched from Earth with barely enough velocity to escape Earth’s gravity. (To understand why the largest of these small moons is about 650 feet in diameter, see Figure 181.)
16. Asteroids 3753 Cruithne, 2010 SO16, 2002 AA₂₉, and a few others are traveling companions of Earth.⁸⁷ They delicately oscillate, in a horseshoe pattern, around two points that lie 60° (as viewed from the Sun) forward and 60° behind the Earth but on Earth’s nearly circular orbit. These points, predicted by Lagrange in 1764 are called *Lagrange points*. They are stable places where an object would not move relative to the planet if the object could once occupy either point going at zero velocity relative to the planet. But how could a slowly moving object ever reach, or get near, either point? Most likely, it barely escaped from Earth.

Also, Asteroid 3753 could not have been in its present orbit for long, because it is so easy for a passing gravitational body to perturb it out of its barely stable

niche. Time permitting, Venus will pass near this asteroid 8,000 years from now and may dislodge it.⁸⁸

17. Each planet has two Lagrange points on its nearly circular orbit. The first, called L4, lies 60° (as seen from the Sun) in the direction of the planet's motion. The second, called L5, lies 60° behind the planet. [See Figure 193.]

Visualize planets and asteroids as large and small marbles rolling in orbitlike paths around the Sun on a large frictionless table. At each Lagrange point is a bowl-shaped depression that moves along with each planet. Because there is no friction, small marbles (asteroids) that roll down into a bowl normally pick up enough speed to roll back out. However, if a chance gravitational encounter slowed one marble after it entered a bowl, it might not exit the bowl. Marbles trapped in a bowl would normally stay 60° ahead of or behind their planet, gently rolling around near the bottom of their moving bowl.

One might think an asteroid is just as likely to get trapped in Jupiter's leading bowl as its trailing bowl—a 50–50 chance, as with the flip of a coin. Surprisingly, 1068 asteroids are in Jupiter's leading (L4) bowl, but only 681 are in the trailing bowl.⁸⁹ This shouldn't happen in a trillion trials if an asteroid is just as likely to get trapped at Jupiter's L4 as L5. What concentrated so many asteroids near the L4 Lagrange point?

According to the hydroplate theory, asteroids formed near Earth's orbit. Then, the radiometer effect spiraled them outward, toward the orbits of Mars and Jupiter. Some spiraled through Jupiter's circular orbit and passed near both Jupiter's L4 and L5. Asteroids that entered the "L5 bowl" received a forward gravitational tug from Jupiter that tended to pull them *out* of that bowl, while those that entered the "L4 bowl" received a backward gravitational tug that tended to keep them *in* the "L4 bowl." The excess number of asteroids near Jupiter's L4 is what we would expect based on the hydroplate theory.

18. NASA is planning to launch two 450 million dollar (U.S.) space missions, one of which will examine two of Jupiter's Trojan asteroids in 2030. Why? Because NASA thinks they are "oddballs."⁹⁰ One of the "oddball" Trojans, named "Psyche," is an iron and nickel asteroid. NASA scientists think that billions of years ago Jupiter and its Trojan asteroids condensed from the same swirling dust cloud, so why are Psyche and Jupiter (a gas planet) so different? Those scientists should (1) learn the origin of asteroids, (2) understand why asteroids spiraled outward, allowing many to settle into two of Jupiter's Lagrange points (L4 and L5), and (3) learn how iron and nickel collected in the base of Earth's pre-flood pillars before they were smashed and the

fragments launched into space by the fountains of the great deep. Of course Psyche and Jupiter are different.

In 2032, the second mission will examine two of Jupiter's Trojans that are orbiting each other. That also puzzles NASA's scientists, because only one slight gravitational perturbation over millions of years would separate the delicately orbiting pair, especially with so many other perturbing asteroids nearby. What a waste of taxpayer's money, since these observations (and hundreds of others) are explained or predicted by the hydroplate theory.

19. Without the hydroplate theory, one has difficulty imagining situations in which an asteroid would (a) settle into any of Jupiter's Lagrange points (let alone one of Jupiter's symmetric Lagrange points), (b) capture a moon, or (c) have a circular orbit, along with its moon, about their common center of mass. If all three happened to an asteroid, astronomers would be shocked; no astronomer would have predicted that it could happen to a comet. Nevertheless, an "asteroid" discovered earlier, named 617 Patroclus, satisfies (a)–(c). Patroclus and its moon, Menoetius, have such low densities that they would float in water; therefore, both are probably comets⁹¹—dirty, fluffy snowballs. Paragraphs 6, 11, 12, and 17 (above) explain why these observations make perfect sense with the hydroplate theory.
20. Asteroid 2015BZ₅₀₉ travels very near Jupiter's entire orbit—but backwards (*retrograde*, clockwise as viewed from the north star)! This presents astronomers with three problems,⁹² all solved by the hydroplate theory.
- If 2015BZ₅₀₉ has been there for millions of years, how did it avoid colliding with the more than a thousand asteroids traveling *prograde* near Jupiter's orbit?
 - Why, after all this time, has Jupiter's gigantic gravity not flung 2015BZ₅₀₉ far from its current orbit?
- Answers for a and b: Asteroids are not millions of year old. They formed only a few thousand years ago—as a result of the flood.
- How could an asteroid end up in a retrograde orbit?
- Answer: Some of the debris launched by the fountains of the great deep (that later merged to become asteroids) orbited the Sun in the retrograde direction.
21. As explained in "Shallow Meteorites" on page 40, meteorites are almost always found surprisingly near Earth's surface. The one known exception is in southern Sweden, where 40 meteorites and thousands of grain-size fragments of one particular type of meteorite have been found at different depths in a few limestone

Meteorites Return Home

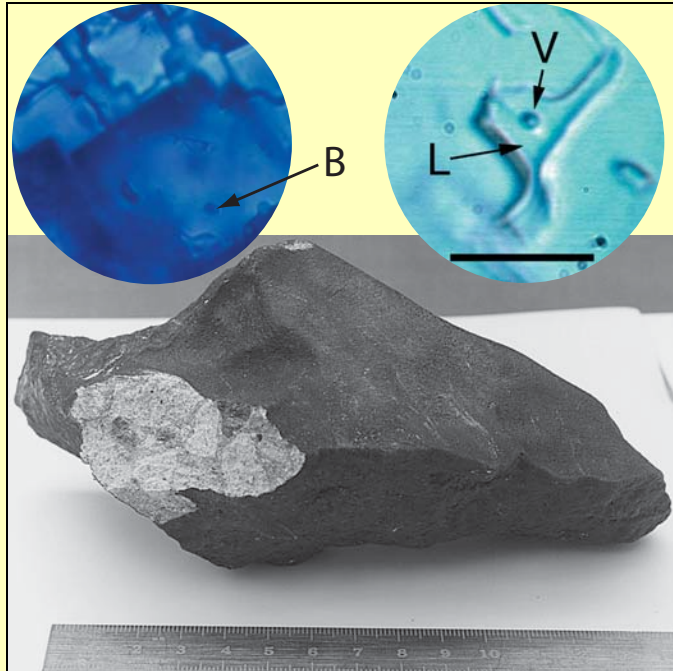

Figure 194: Salt of the Earth. On 22 March 1998, this 2¾ pound meteorite landed 40 feet from boys playing basketball in Monahans, Texas. While the rock was still warm, police were called. Hours later, NASA scientists cracked the meteorite open in a clean-room laboratory, eliminating any possibility of contamination. Inside were salt (NaCl) crystals 0.1 inch (3 mm) in diameter and liquid water!⁹³ Some salt crystals are shown in the blue circle, highly magnified and in true color. Bubble (B) is inside a liquid, which itself is inside a salt crystal. Eleven quivering bubbles were found in about 40 fluid pockets. Shown in the green circle is another bubble (V) inside a liquid (L). The horizontal black bar represents 0.005 mm, about 1/25 the diameter of a human hair.

NASA scientists who investigated this meteorite believe it came from an asteroid, but that is highly unlikely. Asteroids, having little gravity and being in the vacuum of space, cannot sustain *liquid* water, which is required to form salt crystals. (Earth is the only planet, indeed the only body in the solar system, that can sustain liquid water on its surface.) Nor could surface water (gas, liquid, or solid) on asteroids withstand high-velocity impacts. Even more perplexing for the evolutionist: What is the salt's origin?⁹⁴

Figure 42 on page 108 illustrates the origin of meteoroids. Dust-size meteoroids often come from comets. Most larger meteoroids are rock fragments that never merged into a comet or asteroid.

Don't be fooled by claims that all water on Earth was delivered by meteorites. [Some problems with that idea are explained at "[Earth: The Water Planet](#)" on page 27.] Such claims are based on a few meteorites containing traces of

water molecules whose isotope signatures perfectly match water on Earth today. This isotopic evidence also supports this book's contention that those meteorites and the water they contain were both launched from Earth by the fountains of the great deep as the flood began. The following evidence supports Earth as the origin of meteorites.

- ◆ Minerals and isotopes in meteorites are remarkably similar to those on Earth.⁴¹
- ◆ Hundreds of meteorites, called *ureilites*, contain tiny diamonds.⁴⁸ Since meteorites came from outer space and diamonds are carbon, where did such concentrations of carbon come from? Vegetation doesn't grow in outer space.
- ◆ Some meteorites contain sugars,⁹⁵ salt crystals containing liquid water,⁹⁶ and possible cellulose.⁹⁷
- ◆ Other meteorites contain limestone,⁹⁸ which, on Earth, apparently forms only in liquid water. [See "[The Origin of Limestone](#)" on pages 260–266.]
- ◆ Many meteorites have excess amounts of left-handed amino acids^{99,100}—a sign of once-living matter. [See "[Handedness: Left and Right](#)" on page 18.]
- ◆ NASA has found DNA components in 12 meteorites.¹⁰¹
- ◆ A few meteorites show that "salt-rich fluids similar to terrestrial brines" flowed through their veins.¹⁰²
- ◆ Some meteorites have about twice the heavy hydrogen concentration as Earth's water today.¹⁰³ As explained in the preceding chapter and in Endnote 89 on page 426, this heavy hydrogen came from the subterranean chambers.
- ◆ About 86% of all meteorites contain chondrules, which are best explained by the hydroplate theory. [See "[Chondrules](#)" on page 410.]
- ◆ Bacteria fossils have been found in three meteorites.¹⁰⁰
- ◆ Seventy-eight types of *living* bacteria have been found in two meteorites after extreme precautions were taken to avoid contamination.¹⁰⁴ Bacteria need liquid water to live, grow, and reproduce. Obviously, liquid water does not exist inside meteoroids whose temperatures in outer space are near absolute zero (–460°F). Therefore, the bacteria must have been living in the presence of liquid water before being launched into space. Once in space, they quickly froze and became dormant. Had bacteria originated in outer space, what would they have eaten?
- ◆ The Earth could not have formed from meteoritic bombardment. [See "[Molten Earth?](#)" on page 28.]

Meteorites containing diamonds, chondrules, salt crystals, water, limestone, DNA components, possible cellulose, sugars, living and fossil bacteria, terrestrial-like brines, excess left-handed amino acids, heavy hydrogen, and earthlike minerals, isotopes, and other components¹⁰⁵ implicate Earth as their source—and the fountains of the great deep as the powerful launcher.

quarries. The standard explanation is that all these meteorites somehow struck this same small area over a 1–2-million-year period about 480-million years ago.¹⁰⁶

A more likely explanation is that a meteorite launched during the flood did not have quite enough velocity to escape Earth's gravity. The meteorite

fragmented into many pieces as it slammed back into the atmosphere. The pieces embedded themselves at slightly different depths in mushy, recently-deposited limestone layers in what is now southern Sweden.

22. Light spectra (detailed color patterns, much like a long bar code) from so many comets and asteroids show that complex organic compounds and kerogen, a coal-tar residue¹⁰⁷—and even amino acids—were in those bodies when they formed.¹⁰⁸ Life as we know it could not survive in such a cold, radiation-filled region of space, but common organic matter launched from Earth could have been preserved.
23. Many asteroids are reddish and have light characteristics showing the presence of iron.¹⁰⁹ On Earth, reddish rocks almost always imply iron oxidized (rusted) by oxygen gas. If iron on asteroids is oxidized, the oxygen probably came from dissociated water molecules.

Mars, often called the red planet, derives its red color from oxidized iron. Again, oxygen in the water vapor launched from Earth during the flood probably accounts for Mars' red color.

Mars' topsoil is richer in iron and magnesium than Martian rocks beneath the surface. The dusty surface of Mars also contains carbonates, such as limestone.¹¹⁰ Because meteorites and Earth's subterranean water contained considerable iron, magnesium, and carbonates, it appears that Mars was heavily bombarded by meteorites and water launched from Earth's subterranean chamber. [See "The Origin of Limestone" on pages 260–266.]

Those who believe that meteorites came from asteroids have wondered why meteorites do not have the red color of most asteroids.¹¹¹ The answer is twofold: (a) as explained on page 342, meteorites did not come from asteroids but both came from Earth, and (b) asteroids have their red color because they contain water that oxidizes the iron in the asteroid's rocks.

24. Mars has relatively little gravity, travels very near the asteroid belt, and has a thin atmosphere. However, Mars should not have any atmosphere if asteroids have been pummeling it for 4.5 billion of years. Evidently, asteroids have not been around for 4.5-billion years.¹¹²
25. Asteroids and comets delivered that water to Mars. (All asteroids and comets formed from rocks and water launched at the beginning of the flood by the fountains of the great deep.) This is confirmed by the unusual deuterium-to-hydrogen ratio found in water locked in Martian clays. That ratio is the same as we determined was in water launched from the subterranean chamber when the flood began.¹¹³

26. Mars' water does not need to be replenished, because so much water was delivered, and it happened recently (only about 5,000 years ago). Therefore, Mars' water has had little time to escape.

Because of its distance from the Sun, Mars is cold, averaging at least -80°F (112°F below freezing). One might think that any liquid water on Mars surface would quickly freeze, especially at Mars' low atmospheric pressures.¹¹⁴ However, comparisons of detailed photographs show that water has flowed on Mars within the last few years¹¹⁵—and today, during Martian summers, saltwater appears to flow out of equatorial facing slopes!¹¹⁶ How could that be?¹¹⁷

Did the liquid water originally come from below Mars' surface or above? Many say that subsurface water on Mars migrated upward for hundreds of miles to the surface. However, that would not carve erosion gullies on crater walls, as shown in Figure 195, or on a Martian crater's central peak. Besides, the water would freeze a mile or two below the surface.¹¹⁸ Even volcanic eruptions on Mars would not melt ice fast enough to release the estimated 10–1,000 million cubic meters of water per second needed to cut each stream bed.¹¹⁹ (This exceeds the combined volume flow rate of all of Earth's rivers that enter oceans.)

The salty water came from above Mars' surface. Soon after Earth's global flood, the radiometer effect spiraled asteroids out to the asteroid belt, just beyond Mars, where there were frequent opportunities to collide with Mars. Comets also impacted Mars. When an icy impact occurred, the impactor's kinetic energy became heat energy, instantly melted some ice, gouged out a crater, and kicked up into Mars' thin atmosphere large amounts of debris mixed with water (liquid, ice crystals, and vapor)—and complex organic molecules that obviously came recently from life.¹²⁰ Then, the dirt and salt-water mixture settled back to the surface in vast layers of thin sheets—strata—especially around the crater.

Mars' stream beds usually originate on parts of crater walls instead of in smaller tributaries as on Earth.¹²¹ Martian drainage channels and layered strata are found at almost 200 isolated locations.¹²² Most gullies are on crater slopes at high latitudes¹²³—extremely cold slopes that receive little sunlight. One set of erosion gullies is on the central peak of an impact crater.¹²⁴

Impact craters at many latitudes sometimes expose thin ice layers a foot or so beneath Mars' surface.¹²⁵ "At polar latitudes, as much as 50 percent of the upper meter of soil may be [water] ice."¹²⁶

Icy asteroids and comets bombarding Mars released liquid water, which often pooled inside craters or flowed downhill and eroded the planet's surface.¹²⁷ (Most liquid water soaked into the soil and froze.) Each impact was like the bursting of a large dam here on Earth. Brief periods of intense, hot rain and localized flash floods followed.¹²⁸ These Martian

Are Some Meteorites from Mars?

Widely publicized claims have been made that 150 meteorites from Mars have been found. With international media coverage in 1996, a few scientists also proposed that one of these meteorites, named ALH84001, contained fossils of primitive life. Later studies rejected that claim.

The wormy-looking shapes discovered in a meteorite [supposedly] from Mars turned out to be purely mineralogical and never were alive.

Those 150 meteorites are presumed to have come from the same place, because they contain similar ratios of three types of oxygen: oxygen weighing 16, 17, and 18 atomic mass units. (That presumption is not necessarily true, is it?) A chemical argument then indirectly links *one* of those meteorites to Mars, but the link is more tenuous than most realize.¹³⁰ That single meteorite had tiny glass nodules containing dissolved gases. A few of those gases (basically the noble gases: argon, krypton, neon, and xenon) had the same *relative* abundances as those found in Mars' atmosphere in 1976. (Actually, a later discovery shows that the mineralogy of these meteorites differs from that of almost all Martian rock.¹³¹) Besides, if two things are similar, it does not mean that one came from the other. Similarity in the relative abundances of the noble gases in Mars' atmosphere and in one meteorite may be because those gases originated in Earth's preflood subterranean chamber.¹³² Rocks and water from the subterranean chamber may have transported those gases to Mars.

Could those 150 meteorites have come from Mars? To escape the gravity of Mars requires a launch velocity of *3 miles per second*. Additional velocity is then needed to transfer to an orbit intersecting Earth, 34–236 million miles away. Supposedly, one or more asteroids slammed into Mars and blasted off millions of meteoroids. Millions are needed, because less than one in a million¹³³ would ever hit Earth, be large enough to survive reentry, be found, turned over to scientists, and analyzed in detail. Besides, if meteorites can come to Earth from Mars, many more should have come from the Moon—but haven't.¹³⁴ Furthermore, all the so-called Martian meteorites are magnetic,¹³⁵ whereas Mars has no magnetic field.

For *an impact* to accelerate, in a fraction of a second, any solid from rest to a velocity of 3 miles per second requires such extreme shock pressures that much of the material would melt, if not vaporize.¹³⁶ All 150 meteorites should at least show shock effects. Some do not. Also, Mars should have at least six giant craters if such powerful blasts occurred, because six different launch dates are needed to explain the six age groupings the meteorites fall into (based on evolutionary dating methods). Such craters are hard to find, and large, recent impacts on Mars should have been rare.

Then there are energy questions. Almost all impact energy is lost as shock waves and ultimately as heat. Little energy remains to lift rocks off Mars. Even with enough energy, the fragments must be large enough to pass through Mars' atmosphere. To see the difficulty, imagine throwing a ball high into the air. Then, visualize how hard it would be to throw a handful of dust that high. Atmospheric drag absorbs too much of the smaller particles' kinetic energy, even in Mars' thin atmosphere. Finally, for large particles to escape Mars, the expelling forces must be focused, as occurs in a gun barrel or rocket nozzle. For best results, this should be aimed straight up, to minimize the path length through the atmosphere.

A desire to believe in life on Mars produced a type of "Martian mythology" that continues today. In 1877, Italian astronomer Giovanni Schiaparelli reported seeing grooves on Mars. The Italian word for groove is "canali"; therefore, many of us grew up hearing about "canals" on Mars—a mistranslation. Because canals are man-made structures, people started thinking about "little green men" on Mars.

In 1894, Percival Lowell, a wealthy, amateur astronomer with a vivid imagination, built Lowell Observatory primarily to study Mars. Lowell published a map showing and naming Martian canals, and wrote several books: *Mars* (1895), *Mars and Its Canals* (1906), and *Mars As the Abode of Life* (1908). Even into the 1960s, textbooks displayed his map, described vegetative cycles on Mars, and explained how Martians may use canals to convey water from the polar ice caps to their parched cities. Few scientists publicly disagreed with the myth, even after 1949 when excellent pictures from the 200-inch telescope on Mount Palomar were available. Those of us in school before 1960 were directly influenced by such myths; almost everyone has been indirectly influenced.

Artists, science fiction writers, and Hollywood helped fuel this "Martian mania." In 1898, H. G. Wells wrote *The War of the Worlds* telling of strange-looking Martians invading Earth. In 1938, Orson Welles, in a famous radio broadcast, panicked many Americans into thinking New Jersey was being invaded by Martians. In 1975, two Viking spacecraft were sent to Mars to look for life. Carl Sagan announced, shortly before the tests were completed, that he was certain life would be discovered—a reasonable conclusion, *if life evolved*. The prediction failed. In 1996, United States President Clinton read to a global television audience, "More than 4-billion years ago this piece of rock [ALH84001] was formed as a part of the original crust of Mars. After billions of years, it broke from the surface and began a 16-million-year journey through space that would end here on Earth." "... *broke from the surface ...*?" The myth is still alive.

The Tagish Lake Meteorite

Evolutionists understand how hard it is for most people to believe life evolved on Earth, and the media know how excited the public is with the idea of life evolving on other planets. This may explain why evolutionists and the media are increasingly claiming that life came from outer space.

The universe is aswarm with the stuff of biology—and it could be seeding life everywhere ... and meteors that landed on Earth have been found to contain amino acids, nucleobases—which help to form DNA and RNA—and even sugars.

(*Time Magazine*, “Aliens Among Us,”
22 October 2012, pp. 44, 46.)

Such statements overlook obvious facts and a simple explanation. Let's look at just one piece of scientific evidence. One of the most studied meteorite falls in modern times occurred at 4:43 PM on 18 January 2000 at Tagish (TA-jis) Lake in northwestern British Columbia, Canada. A meteoroid, estimated to be 112,000 pounds and 13 feet in diameter, struck Earth's upper atmosphere. About 97% of the rock burned up in the atmosphere; most of the rest fell onto the frozen lake, greatly reducing the chance of contamination. More than 500 black fragments (totaling 22 pounds) were soon recovered on the ice and later analyzed by an international team of twenty scientists.¹³⁷

Organic Matter. Almost 3% (by weight) of these pristine meteorites were *complex organic* molecules, obviously produced by living organisms: amino acids and long strings of carbon-based compounds. How can this be explained?

Rocks and *organic matter from plants and animals* were pulverized and launched by the fountains of the great deep. Some merged to become meteoroids (as well as comets and asteroids). This team of scientists, on the other hand, say they don't know how it all happened, but speculate that the organic matter already existed between the stars before the solar system and meteorites formed.¹³⁸

Same Organic Material in Comet. Organic material in the Tagish Lake Meteorite was so similar to that found in comet Wild 2 that they probably had a common source.¹³⁹ Evolutionists believe that common source was the massive dust cloud from which the entire solar system, including comets, formed 4.6-billion years ago. A much simpler, closer-to-home explanation is that the common source was life that was on Earth only about 5,000 years ago.

Organic Transformations. Transformations from one organic form to another occurred within these rocks

hydrodynamic cycles quickly “ran out of steam,” because Mars receives little heat from the Sun. While the consequences were large for Mars, the total water was small by Earth's standards—about twice the water in Lake Michigan.

Today, when meteorites strike icy soil on Mars, some of that ice melts. Liquid water then flows down the crater

before they struck Earth's atmosphere. In the laboratory, hot, high-pressure water can easily produce such transformations, exactly the conditions present during the early days of the flood.

*This apparently facile [easily accomplished (in high pressure water)] transformation is unexpected. It is most likely caused by hydrothermal alteration, as is observed in experiments involving hydrous pyrolysis of reaction with water at elevated temperature and pressure ...*¹⁴⁰

Evolutionists, admitting that these transformations were unexpected, visualize them occurring on some asteroid, which is ridiculous. Neither high temperatures, high pressures, or liquid water would be present on an asteroid. Some organic molecules were mirror images of each other. Liquid water can produce such transformations.¹⁴¹

Water Soluble Compounds. Scientists discovered that many organic compounds inside the Tagish Lake meteorite had been dissolved in water *before* the meteorite struck Earth's atmosphere. How could that be?

Liquid water on Earth did the dissolving and then the rocks and organic material were launched into space. Liquid water and organic matter almost never exist in outer space—let alone get close enough together for the water to slowly dissolve the organic matter.

Neutron Enrichment. These meteorites were rich in hydrogen-2, carbon-13, and nitrogen-15 (instead of the normal hydrogen-1, carbon-12, and nitrogen-14).¹⁴² Why? As will be explained in the next chapter, when the flood began, these elements absorbed neutrons from the sea of neutrons generated in the fluttering crust. With no specifics or evidence, evolutionists believe these neutron-heavy isotopes formed in the interstellar medium more than 4.6-billion years ago.

Clays. Small amounts of clays are found in these meteorites. Clays are produced by water acting on rock—either slowly over a long time or violently over a short time. High pressure water escaping violently and hypersonically from the subterranean chamber produced these clays in rocks swept up in the fountains of the great deep.

Although asteroids are hundreds of degrees too cold to sustain liquid water, evolutionists believe that liquid water on asteroids produced the clays over millions of years and, later, impacts on asteroids chipped off the rocks that remarkably traveled to Earth to become meteorites.

wall, leaving the telltale gullies that have shocked the scientific community.¹¹⁵

Since Martian ice melts when equatorial and mid-latitude temperatures are below 32°F (0°C), salts must be dissolved in the water to lower its freezing point. Other clues have narrowed the type of dissolved salts to chlorides (sodium,

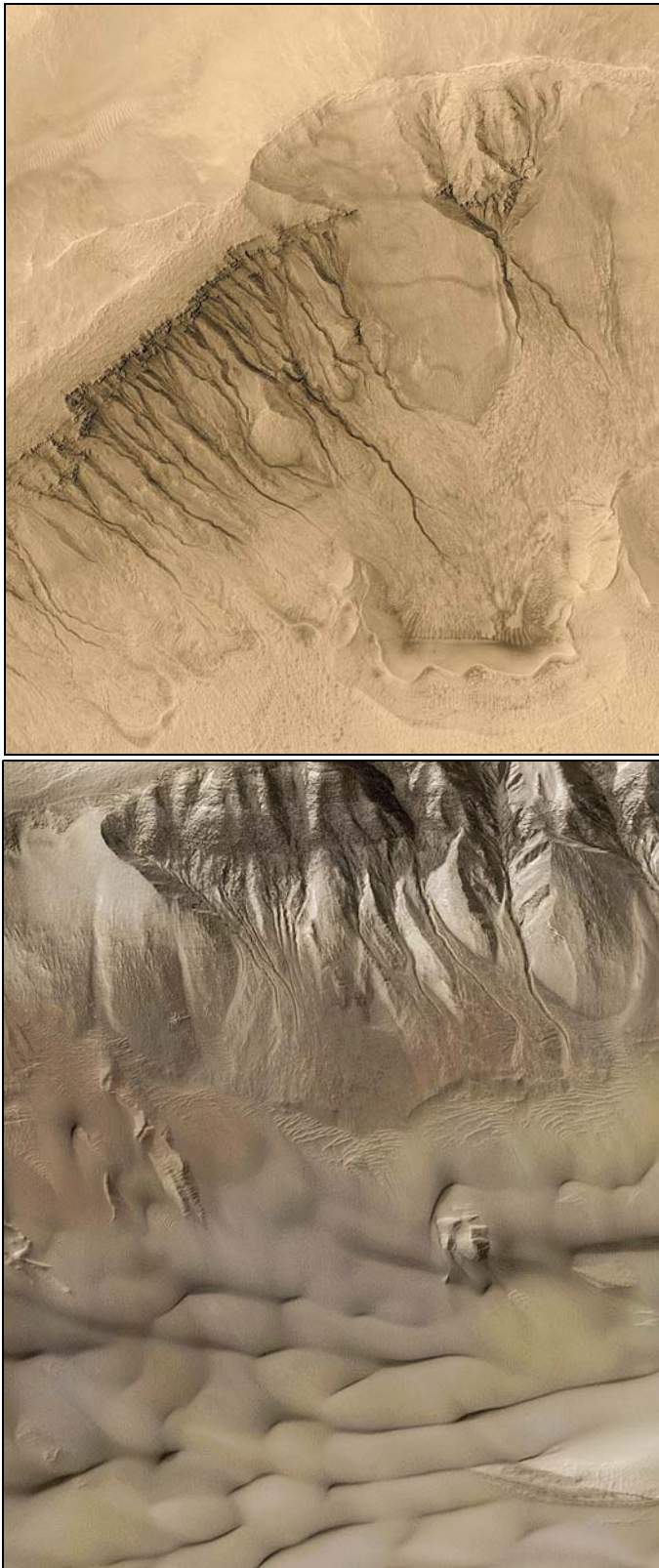

Figure 195: Erosion Channels on Mars. These erosion channels frequently originate in scooped-out regions, called *amphitheaters*, high on a crater wall. On Earth, where water falls as rain, erosion channels begin with narrow tributaries that merge with larger tributaries and, finally, “rivers.” Comet and asteroid impacts would have instantly formed these craters, gouged out amphitheaters, and melted the impactor’s ice. Mars, whose average equatorial temperature is colder than the average temperature in Antarctica, would need a heating source, such as impacts, to produce liquid water.

More Water on Mars: A Lake, 1-Mile Underground

“Discoveries of water on Mars are now so common that the subject has become the butt of jokes among planetary scientists: ‘Congratulations—you’ve discovered water on Mars for the 1,000th time!’”¹⁴³

With so much evidence that water has flowed on Mars, astronomers face multiple dilemmas: With Mars’ extremely cold temperatures, water would be ice, not a liquid. And because of Mars’ thin atmosphere, any liquid water on Mars would be unstable and would immediately boil away—with a poof. Astronomers also admit two other problems: *“We don’t know where the water comes from [and] how does it get replenished.”*¹⁴⁴ The answers are obvious to readers of this chapter.

Some say that Mars’ surface water must contain salts that lower the water’s freezing temperature. They seldom explain why that water was ever stable enough to dissolve any salt—or state the salt’s origin. Next, they will say that millions of years ago Mars could have had a much thicker atmosphere. Notice that these proposals have no supporting evidence. They are simply guesses to solve a scientific problem—liquid water on Mars. This is the sad practice of *“science by imagination.”* Contrast that with my predictions, based on Earth’s global flood, of salt and water on Mars: Predictions 29 and 57 on page 468.

The average temperature at Mars’ South Pole is a frigid -67 degrees °F (-55° C.). So how could a lake, 12 miles in diameter be filled with *liquid* water, no matter how much salt was present? (Water saturated with salt freezes at -21° C.) And how did that liquid remain long enough to be buried a mile under Mars’ South Pole?¹⁴⁵

Answers: Soon after the flood began, comets and asteroids formed from the water and rocks launched into space by the fountains of the great deep. (As explained in Endnote 5 on page 326, about 38% of a comet’s mass is water ice.) As the Sun’s energy pushed comets and asteroids farther and farther from the Sun, some collided with Mars. The kinetic energy of those high-velocity impactors melted their ice and formed craters that became lake basins that then held the liquid water. The tops of those lakes quickly froze, insulated the liquid water below from the cold Martian atmosphere, and became platforms on which a mile-thick layer of debris from that impact, and subsequent impacts, settled and provided more insulation. See Endnote 127 on page 374.

Because the flood was a fairly recent event, not all the initial heat in the lake has had time to escape through the thick insulation above. Therefore, liquid water remains.

Other Martian lakes that formed in a similar way will probably be found. As I have predicted, they will contain microbial life *transported from Earth by the fountains of the great deep.* (If so, watch out; evolutionists will claim that life evolved on Mars.) Exploring underground Martian lakes will be a major reason for sending astronauts to Mars.

magnesium, or calcium).¹¹⁶ Also, water appears to be draining down 25°–40° slopes in streams that are up to 1,800 feet long and 1–15 feet wide! (Those dark drainage streaks slowly disappear in the fall and winter, only to begin growing the next spring.) With so much liquid water draining at lower latitudes, that water must have been placed there recently.¹⁴⁶ Liquid water that evaporates on Mars, ends up near the poles as frost.



PREDICTION 47: Most sediments taken from layered strata on Mars and returned to Earth will show that they were deposited through Mars' atmosphere, not through water. (Under a microscope, water deposited grains have nicks and gouges, showing that they received many blows as they tumbled along stream bottoms. Sediments deposited through an atmosphere receive few nicks.)

Mars also has bulk water ice at its equator—at less than 1 meter depths and under “unusually low density soil.” Peak summer surface temperatures on Mars within $\pm 30^\circ$ latitude of Mars' equator are warm enough to melt ice.¹⁴⁷ How can the existence of this ice be explained?

In summary, comets and asteroids containing large amounts of water ice bombarded Mars for centuries after the flood. Although that ice instantly became liquid water upon impact, it quickly refroze. Dirt kicked up by the many impacts on Mars settled through Mars' atmosphere, burying and quickly insulating the ice in low density (powdery) soil. Since this happened in the last several thousand years, not enough time has passed for the summer's heat on Mars to soak into even shallow soil to melt the ice.



PREDICTION 48: As has been discovered on the Moon and apparently on Mercury, frost, rich in heavy hydrogen, will be found within asteroids and in permanently shadowed craters on Mars.

The Origin of Trans-Neptunian Objects (TNOs)

A trans-Neptunian object (TNO) is any minor planet orbiting the Sun at a greater average distance than Neptune.

“There are at least 70,000 TNOs with diameters larger than 100 km [62 miles].”¹⁴⁸

Powerful telescopes can see and precise orbits are known for 2,300 TNOs. They are usually 30–1500 miles in diameter. However most are unseen, but detected by their gravity.

The *Kuiper Belt*—a doughnut-shaped region 30–50 AU from the Sun—contains about 70% of all TNOs—those with nearly circular orbits near the plane of the ecliptic. According to the hydroplate theory (as will be explained), radial forces and the Sun's energy acted on the larger asteroids and spiraled them out beyond Neptune where they are now called TNOs, not asteroids. TNOs are larger than asteroids in the inner solar system—except for a few

asteroids that may have merged after the flood. TNOs have a total weight of 3% of Earth's mass, give or take 1%.¹⁴⁹

Phoebe. About 30% of these TNOs were perturbed in their outward spirals from Earth by the giant planets and are now scattered around the Kuiper belt. A few were captured by the giant planets. Phoebe, a tiny moon of Saturn, is one example. Its capture explains (1) its relatively eccentric orbit which is almost perpendicular to Saturn's equatorial plane, and (2) the unusual spectral characteristics of its water-rich surface, which match those of TNOs.¹⁵⁰



PREDICTION 49: Table 21 on page 369 lists the irregular moons of the giant planets. Some of them will show the spectral characteristics of Phoebe and TNOs, because they too came from Earth.⁵⁶

Recall that the asteroid belt contains 90% of all asteroids—those that were not scattered as they spiraled outward. So, the asteroid belt, like the Kuiper Belt, is also a doughnut-shaped region in the plane of the ecliptic. Because of their smaller size, asteroids in the inner solar system “ran out of steam” when they were only about 2.8 AU from the Sun.

Crystalline Water-Ice. Quaoar [KUA wahr], the 5th largest TNO, and Charon, Pluto's largest moon, have *crystalline* water-ice on their surfaces.¹⁵¹ That ice, which has the familiar hexagonal pattern of snowflakes, forms only at temperatures warmer than -260°F , but temperatures in the TNO region are much colder—about -370°F . Water-ice at that temperature should be amorphous—water molecules stacked randomly, like the molecules in glass.¹⁵¹ Therefore, those TNOs were once in a warmer environment, such as that of the inner solar system. After about 40,000 years to 10-million years, ultraviolet light and cosmic rays should have bombarded and randomized those ice molecules, so they are no longer crystalline.¹⁵² Since this has not yet happened, that ice is probably young.

Moons. About 11% of TNOs—and asteroids in the inner solar system—have moons,¹⁵³ a fact that baffles astronomers who had scoffed at the possibility that an asteroid could have a moon. Scoffing ended in 1993 when spacecraft began photographing moons orbiting asteroids. [See [Figure 180](#) on page 336.] Pluto, the largest TNO, has five known moons!

How could TNOs acquire moons? Capturing a moon while beyond Neptune's orbit should be almost impossible.¹⁵⁴ Too much empty space separates adjacent bodies. A potential moon, falling thousands of miles toward a TNO, would almost certainly be traveling too fast to be captured as a moon; it would whip around the TNO and speed away as fast as it fell in. To capture a moon, other bodies must be near the TNO (and in just the right places at the right time) *to slow the potential moon down gravitationally*. But again, too much empty space lies between adjacent bodies

to expect that other bodies would be near the TNO—let alone in the right places. Besides, how could Pluto have hung onto its five moons? Gravitational perturbations by so many potential moons whipping by Pluto would have stripped off its moons—certainly in a million years.

Plutinos. One-fourth of the TNOs in the Kuiper Belt are called plutinos. As their name implies, plutinos are smaller versions of Pluto, the most famous TNO. Pluto and plutinos occupy the inner portion of the Kuiper Belt and have a stable 2:3 resonance with the giant planet Neptune. That is, for every two orbits a plutino makes around the Sun, Neptune makes exactly three orbits.

Resonances.: Two Choices. It is clear that Neptune has gravitationally caused plutinos to be in resonance with Neptune. This could be because (1) plutinos migrated through Neptune’s orbit, or (2) because Neptune moved past the plutinos. Obviously, it is much easier to move smaller bodies than large bodies. (Neptune is 3,400 times more massive than the largest plutino.) As you will see, the hydroplate theory explains four mechanisms that moved asteroids, TNOs, and plutinos. Some have claimed that Neptune moved as it was forming from much smaller objects that gravitationally pulled it away from the Sun. However, that proposal requires too many unverifiable “just so” conditions, and has received little acceptance.

Many other TNOs have resonances with Neptune (not just the more common and very stable 2:3 but also 3:5, 4:7, 1:2, 2:5, and others). Therefore, we could have concluded that TNOs spiraled out through Neptune’s orbit—choice (1) above—since it required the least energy and the fewest assumptions. Knowledge of the hydroplate theory was not required, although the hydroplate theory provides the simple mechanisms. (Today most TNO’s are too far from Neptune to be significantly perturbed by its gravity).

Contact Binaries. Surprisingly, half of the plutinos appear to be contact binaries¹⁵⁵—two bodies that once orbited each other but now are in permanent contact. Figures 190 and 191 on page 348 show examples of asteroids that are contact binaries. Notice their peanut-like shapes. Contact binaries are like spinning dumbbells in outer space—two massive weights joined by a very short rod. Figure 190’s caption explains why they mystify astronomers and how, based on the hydroplate theory, they formed among some asteroids, comets and, most surprisingly, TNOs.

In 2014, the European Space Agency’s Rosetta mission, landed instruments for the first time on a comet, Comet 67P—a spectacular engineering achievement. [See page 309.] After weeks of study to understand its surprising shape, it too was determined to be a contact binary—a comet shaped like what the media called a “rubber duckie.” The body of the “rubber duckie” was the larger of the pair of spherical comets, and the duck’s head, stuck onto the body, was the smaller comet.

Rings. At least one TNO has rings, similar to those around Saturn, Uranus, Neptune, and Jupiter!¹⁵⁶ [See Figure 25 on page 30.] It has been difficult enough for astronomers to explain how rings formed around the giant planets;¹⁵⁷ how can they now explain rings around TNOs as well? To make matters worse, rings are also around centaurs, bodies that resembles both comets and asteroids, and therefore are named centaurs, after the mythical man/horse creatures. One centaur, Chariklo, has icy rings¹⁵⁸ that appear to be young (a few thousand years old).¹⁵⁹

An estimated 44,000 centaurs are larger than 1 kilometer (0.6 mile). All are unstable, because they cross the orbits of the giant planets and frequently collide with or are ejected by those giants. Therefore, centaurs are quite young.

How young? Horner et al. simulated centaur orbits both forward and backward in time and found that centaurs have a half-life of about 2,700,000 years.¹⁶⁰ This means they are probably younger than 10,000,000 years and could be much younger—such as a few thousand years. They could not have formed when evolutionists say the solar system was evolving—4,500,000,000 years ago.

[Centaur Chariklo] *“has two narrow, dense rings separated by a small gap.”*¹⁶¹ *“There’s no doubt that there’s a ring, but nobody knows what it means. Even planetary rings are an enigma.”*¹⁶²

Rings around planets, TNOs, and centaurs are not an enigma, but are easily explained by the hydroplate theory. Large gravitational bodies frequently perturbed the outward spiraling asteroids and TNOs, causing those flying rock piles to become scattered rocks orbiting as rings around those bodies. **This is how Saturn (and the other giant planets) got their rings.** [See “**Planetary Rings**” on page 29.] Large pieces of asteroids or TNOs that didn’t completely fragment frequently became centaurs with rings.



PREDICTION 50: Many TNOs will be found with rings.

In 2017, NASA’s Cassini spacecraft ended its 19-year, 4-billion dollar mission to Saturn by diving many times between Saturn’s rings. NASA’s scientists thought the spacecraft would collide with particles between those rings and disintegrate. Everyone was surprised that those gaps were almost empty.¹⁶³ Obviously, not enough time had passed since the rings formed for many ring particles to scatter into those gaps. Again, the rings are young.

Reddish, Similar to Asteroids. In 1992, TNOs began to be discovered and their common characteristics identified. Planet Pluto, discovered in 1930, fit these characteristics, so Pluto can be considered both a TNO and (for historical reasons) a planet. [See “**Is Pluto a Planet?**” on page 28.] Like Mars and many asteroids, TNOs are often reddish

in color¹⁶⁴ probably due to surface rocks containing oxidized (rusted) iron. The oxygen may have come from the water (H₂O) launched from Earth by the fountains of the great deep. [See Item 23 on page 354.]

Young Pluto. NASA's New Horizons spacecraft arrived at Pluto on 14 July 2015 and found signs of youth: towering mountains (15,000 feet high) made of water ice,¹⁶⁵ and the absence of craters on both Pluto and its largest moon, Charon. If some surface process filled in craters, how could ice mountains almost as high as the Rockies form and not be eroded in a million years? Jeff Moore of the New Horizons Geology, Geophysics and Imaging Team said, "This is one of the youngest surfaces we've ever seen in the solar system."¹⁶⁶

Even more surprising were the discoveries on Pluto of a frozen lake made of carbon monoxide ice, and an atmosphere being blown 1,600 kilometers (1,000 miles) away from Pluto's solid surface by solar wind, at a rate of 500 tons each hour!¹⁶⁷ Obviously, that loss was too rapid to have been going on for even a million years. Pluto is young.

Pluto's Young Moons. Pluto's five tightly packed moons present another problem. How can they remain in such close proximity to each other for even millions of years (not to mention billions of years) without most being expelled by the gravitational perturbations of the others?

*These tightly packed systems place severe constraints on theories of planetary-system formation. ... How some systems end up with objects in closely packed orbits is an open question.*¹⁶⁷

*It's a little bit mysterious how the four [small] moons got there.*¹⁶⁸

Wide Binaries. At least 70 pairs of TNOs, called **wide binaries**, are seen orbiting each other, but are so far apart that capture should have been nearly impossible!¹⁶⁹ Professor Jean-Luc Margot explains the problem:

*Binary systems—two objects [of similar size] orbiting each other—are astronomical treasures for both the observer and the theorist. Their very existence raises perplexing questions about their formation, stability and evolution. ... seven such objects have now been identified in the Kuiper Belt. ... Such wide separations between [binary pairs] are truly arresting and defy accepted ideas about the processes of binary formation ... How did such a [wide binary] system form? Why does it have such large orbital separation and angular momentum? How did it survive collisions? What does the large proportion of binary Kuiper-Belt objects—estimated as at least 1% of the known population—indicate about the collisional environment in that population?"*¹⁷⁰

Why is each TNO in a wide binary of similar size as its twin, and how can we answer the professor's many other questions?

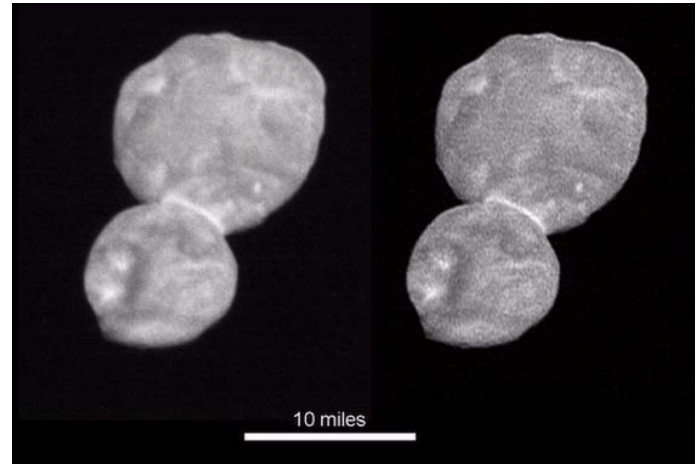

Figure 196: Ultima Thule. These two photographs of the trans-Neptunian object, **Ultima Thule**, were taken on New Year's day in 2019 by NASA's New Horizons spacecraft when it was 4 billion miles from Earth. This was the most distant and technically challenging exploration ever made by man. Can you explain, beginning with the eruption of all the fountains of the great deep, how this extremely distant contact binary formed? If not, read on.

As explained above, capture began during the flood, in the inner solar system when the bodies were much closer together. Gas (from oceans of evaporated water) produced gentle aerobraking, which steadily drew bodies within a sphere of influence closer together. Then, in the years after the flood, these swarms spiraled out to their present locations.

If one swarm had captured another, and their masses and dimensions were similar, both would experience a similar outward thrust from the Sun. Therefore, neither swarm would escape from the other. As each rotating swarm contracted, it eventually became tidally locked to the other, thereby transferring its *rotational* angular momentum to the pair's *orbital* angular momentum about their mutual barycenter. Consequently, they slowly moved farther apart as they spiraled outward. Mysteries solved.

Aerobraking even caused some pairs, such as those shown in Figures 190 191 and 196, to make gentle contact while in the inner solar system. In the centuries after the flood, solar energy spiraled these merged pairs (called contact binaries) out into the Kuiper belt, including one named Ultima Thule (UT),¹⁷¹ which is now a billion miles beyond Pluto. UT was visited on New Year's Day in 2019 by the New Horizons spacecraft that flew by Pluto in July 2015. UT presents the ultimate challenge to astronomers, because mergings—let alone gentle mergings—so far out, where bodies are typically millions of miles apart, should be virtually impossible, as explained in Figure 190 on page 348. However, these gentle mergings did not occur “out there.” they occurred in the inner solar system, crowded by debris launched from Earth as the flood began. Then they spiraled out beyond Pluto.¹⁷² Most bodies in the Kuiper belt are contact binaries.¹⁵⁵

Growth. Since asteroids are flying rock piles, a far more difficult problem is growing an asteroid to the size of a TNO.

An asteroid must capture not just a few rocks, but millions—a mind-boggling task considering how difficult it is to capture only a few rocks as moons.¹⁷³

But the worst problem of all is growing anything in the Kuiper Belt. For the past 150 years, we were all taught that the Solar System began as a swirling dust cloud. If so, the spacing between dust particles in the Kuiper Belt region would have been so great that no gravitational accretion could have occurred. None!

*... there is not enough matter in the Kuiper Belt to account for the existence of any objects of any size. If all the material in all existing KBOs [Kuiper Belt Objects] had started out as a primordial cloud of icy dust, that cloud would have been too widely dispersed to ever form into anything at all. The very existence of the Kuiper Belt therefore appears inconsistent with how theorists believe it must have formed.*¹⁷⁴

Low Density, Similar to Asteroids. The density of a TNO of known size can be calculated if it has a moon whose orbital period and orbital radius are known. Most of those TNOs are unusually light, similar to asteroids. For example, Pluto's density is 2.0 gm/cm³. Therefore, TNOs contain considerable empty space and/or ice. (If a TNO were a solid rock, its density would be about 3.0 gm/cm³.)¹⁷⁵

The Orbital Parameter ω . At least twelve TNOs are unique in that they have large eccentricities (very elongated orbits), higher angles of inclination, and will travel 75–1000 AU from the Sun, much farther than all other known TNOs. Surprisingly, all twelve have similar values for the characteristic called “the argument of the perihelion (ω).”¹⁷⁶ Figure 199 shows what ω represents. It is one of six numbers, called *orbital elements*, which specify the orbit and location of a body in space. Why would all twelve of the most distant TNOs currently known have similar values of ω ? That is less likely than rolling twelve dice and having each be a five or a six.

Astrophysicist Megan E. Schwamb, writing in *Nature* primarily about two of these twelve TNOs (Sedna and 2012 VP₁₁₃), explains the problem this discovery presents.

*The two objects [Sedna and 2012 VP113] have similar values for one of their orbital parameters: the angle [ω] between the point of perihelion and where the orbit crosses the plane of the Solar System [from south to north]. Interestingly, the most distant [TNOs], with semimajor axes greater than 150 AU and perihelia beyond Neptune, also seem to have values for such angles comparable to those of Sedna and 2012 VP113. Such clustering of orbital angles seems to be unexplainable by the gravitational influence of Neptune alone. This result may be the first hint we have of an identifiable signature of the ... formation mechanism [for TNOs]. If true, **any formation mechanism proposed for the origin of***

Sedna and 2012 VP113 [and the other ten most distant TNOs] will need to explain this orbital structure.¹⁷⁷ [emphasis added]

Notice that Schwamb and *Nature's* editors seem to know of no satisfactory explanation for TNOs.

Schwamb's findings are just the “tip of the iceberg.” Not only do her twelve TNOs have ω values that cluster too tightly to be attributed to chance, but all 2,300 TNOs whose orbits are known (taken as a group) have ω values that cluster near either 0° or 180°. Chance could produce such a departure from a random distribution only once out of 10,000 times!¹⁷⁸

Anyone interested can duplicate these results provided by astronautics Professor R. B. Brown. He downloaded from the Jet Propulsion Laboratory's Small-Body Database the orbital elements for all 2,300 TNOs with known orbits. He then constructed a histogram for ω that showed two prominent peaks—one near $\omega = 0^\circ$ and one near $\omega = 180^\circ$. A simple chi-square test showed that the distribution was non-uniform with a confidence level of 99.99%.¹⁷⁹ Professor Brown concluded that “*many TNOs recently received powerful thrusts from near the plane of the ecliptic. Thrusts directed up above the ecliptic, produced ω values near 0°; thrusts directed downward produced ω values near 180°.*” He projected many TNOs and asteroids back in time and showed that Neptune's gravity could have provided that thrust for only a few of these bodies over the last 22,000 years. Therefore, other planets near the ecliptic plane were involved. Were these TNOs even closer to the Sun than Neptune?

If that thrust occurred millions of years ago, random perturbations would have smoothed out those peaks, so the values for ω would have been spread out uniformly between 0° and 360°. ¹⁸⁰ Therefore, “recently” must be less than millions of years ago—perhaps 5,000 years ago. What can explain this?

Another TNO authority described in a different way the discovery that Megan Schwamb explained:

*All the objects beyond 150 astronomical units come closest to the sun, a point known as perihelion, at nearly the same time that they cross the plane of the solar system. There's no reason for these perihelia to bunch up like that. Billions of years of evolution should have left the perihelia scattered, like the rest of the Kuiper Belt—unless something was holding the perihelia in place.*¹⁸¹

On the contrary, there is a straight-forward explanation that will now be given for why all twelve perihelia lie in the orbital plane of the planets—why ω is nearly 0°. Why have those perihelia not scattered after billions of years? Billions of years have not elapsed. TNOs have existed only since the flood, about 5,000 years ago.



Figure 197: Pluto's Mountains and Polygons. The relative flat region, centered on Pluto in the left picture, is a partially frozen lake, about 750 miles in diameter and composed primarily of nitrogen ice, but also methane and carbon monoxide (as explained in Figure 200). The small square (bounded by the dashed white line) on that lake is enlarged in the picture to the right. There, in the bottom left corner, are some of Pluto's 15,000-foot-tall mountains which are made of water ice—not rock.¹⁶⁵ They are almost as tall as Earth's Rocky Mountains. In the top right corner of that right-hand picture are interlocking polygons, much like a pattern in a tile floor. Each polygon is typically 6–25 miles across.¹⁸³ Both Pluto's mountains and polygons tell a fascinating and consistent story.

What was the source of all that water and nitrogen? Earth, sometimes called the water planet, has plenty of water, some launched by the fountains of the great deep into space during the flood. Evolutionists also have difficulty explaining the nitrogen.¹⁸⁴ Earth's atmosphere is 78% nitrogen by volume. Some nitrogen was also expelled into space. Therefore, swarms, especially the largest swarm that became Pluto, had large amounts of water and nitrogen.

What explains Pluto's mountains? Heat. Because Pluto is the largest known TNO, it probably absorbed more heat-producing impacts than all other TNOs as it collapsed from its swarm stage to become a TNO. That sudden heating melted some of Pluto's internal water ice causing slushy geysers to erupt onto Pluto's surface.¹⁸⁵ Eruptions on Earth produce volcanic cones; on Pluto eruptions produced icy mountains, some with calderas on top.

*At some point in Pluto's past, it had a heat source that melted interior reservoirs of volatile ices, such as nitrogen and methane, which later erupted at the surface. The rims of the cryovolcanoes tower as much as 5 or 6 kilometers high and are more than 150 kilometers across, encircling pits that are nearly as deep as the mountains are tall. "When you see a big mountain with a big hole on the top, it generally points to one thing [a caldera]," says Oliver White, a New Horizons scientist at Ames Research Center in Mountain View, California."*¹⁸⁶

Don't be misled by those who say Pluto's considerable internal heat comes from radioactive decay deep inside. There is no direct evidence for radioactive materials inside Pluto. Besides, Pluto's low density (1.86 grams/cubic centimeter) means Pluto cannot have much dense radioactive material.

What explains Pluto's polygons? As the swarm that became Pluto spiraled out into the extremely cold, outer solar system, its water froze, leaving primarily nitrogen gas for Pluto's atmosphere. Eventually the nitrogen atmosphere was so cold it liquefied, fell as rain, and filled craters that were forming from impacts during the swarm's collapse. Nitrogen freezes at a frigid -346°F, but Pluto's atmosphere would have been somewhat warmer than its current -380°F as it was spiraling out. Some heat deep inside Pluto still contributes to the nitrogen lake's slushiness. The lake's surface probably freezes during Pluto's 77-hour-long night and melts during the equally long day.

The polygon patterns are familiar to anyone who has watched a pan of water simmer on the stove. Heat coming up through the bottom of the pan warms and expands the deepest liquid, making it more buoyant and causing it to rise (convect) in multiple columns called Benard cells. At the surface, the liquid cools, contracts slightly, and sinks, completing the circulation. Viewed from the top, these circulating cells take on the shape of polygons. Because Pluto is so small and receives only 1/1,600th of the heat Earth receives from the Sun, Pluto would be frozen solid if it began millions of years ago. It would not have enough internal heat to produce today's vigorous circulation after so much time. As one researcher admitted, "Pluto's surface is surprisingly young and geologically active."¹⁸⁷

Theories for the Origin of Trans-Neptunian Objects

The Hydroplate Theory. Asteroids have already been explained, beginning on page 337. Some asteroids were larger than those typically seen in the inner solar system.

For four reasons, these larger asteroids spiraled out beyond Neptune and became TNOs.

First, each asteroid began as a growing swarm of rocks, ice, and gas orbiting within the sphere of influence of a large

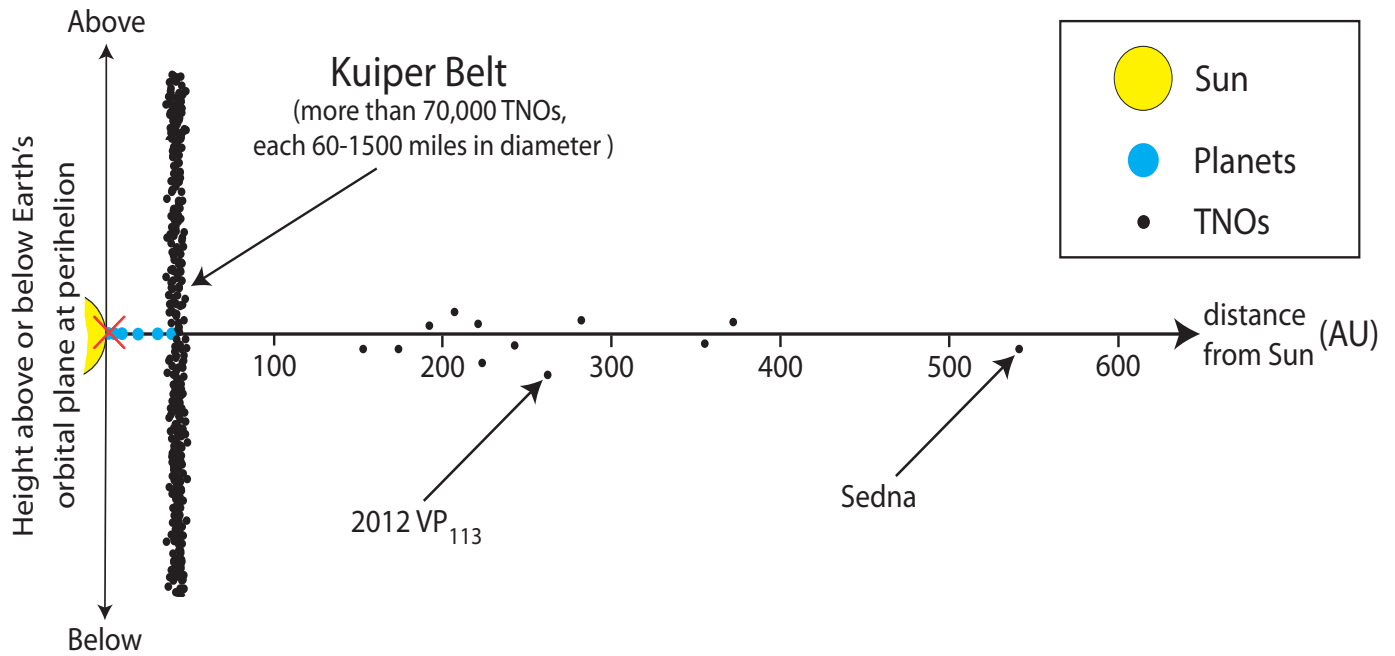

Figure 198: TNOs. Sizes of the Sun, planets, and trans-Neptunian objects (TNOs) are not to scale, although their average distances from the Sun are. Earth is at the red X, 1 astronomical unit (AU) from the Sun. This figure shows several baffling features of TNOs—at least for conventional astronomers. How could the Kuiper Belt have formed so far beyond what was once thought to be the edge of the solar system? Astronomers who have studied TNOs recognize that the Kuiper Belt could not have evolved that far away—or from a swirling dust cloud, that we were incorrectly taught produced the solar system and Earth.¹⁷⁴ *The distribution of [TNOs] exhibits prominent nonrandom features that cannot be readily explained by the current model of the solar system.*¹⁸⁸

Notice how close the twelve most distant TNOs are (at their perihelions) to Earth's orbital plane and how scattered all the other TNOs are from that plane at their perihelions. That extreme closeness cannot be due to chance. What caused it? A simple explanation, based on the hydroplate theory, will be given.

Also, what could account for the twelve TNOs that are more than 150 AU from the Sun, Sedna being at the most extreme distance? Mike Brown, a leading discoverer of TNOs, remarked when learning of Sedna's location so far from the Sun (532 AU on average):

*There's nothing in the solar system today that can put [Sedna] in this orbit. . . . [Sedna] just blew our minds. . . . there had to be something different about the solar system in the past.*¹⁸⁹

Yes, there was something different. The same problem exists for the other eleven most distant TNOs.¹⁹⁰ Table 20 on page 364 lists many TNO mysteries.

Where did conventional astronomers go wrong? Their "swirling dust cloud" is a fiction, and believing in billions of years allows them to imagine and promote hypotheses that cannot be tested. The public has heard little about the tens of thousands of TNOs, because they are so perplexing to astronomers. Scott S. Sheppard, a co-discover of 2012 VP₁₁₃, admitted: "These objects couldn't get out there with what we currently know."¹⁹¹ What don't these experts "currently know"? The consequences of the earthshaking, catastrophic global flood.

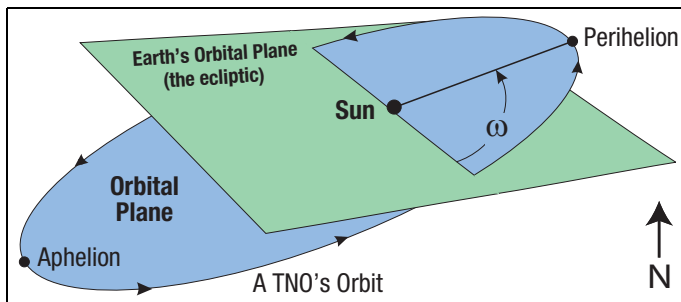

Figure 199: The Orbital Parameter ω .

"seed" rock. As its sphere of influence grew, it pulled in more mass and grew even more. Larger swarms intercepted more of the Sun's radiation, especially for a few years after the flood. As explained earlier, the Sun's gigantic energy produced

the thrust that spiraled swarms and asteroids outward.

Second, larger swarms had more gravity, so they could hang on to their gases more firmly. Those gases were heated on the day side and, therefore, reached higher pressures than gases on the frigid night side. As long as gases remained, the swarms acted as Carnot [CAR-no] engines,¹⁸² delivering thrust from the greater pressure pushing the swarms away from the Sun. The difference between the heat absorbed by the swarm and the heat rejected (one-half rotation cycle later) became thermodynamic work—a force (thrust) acting through a distance.

As each swarm moved farther from the Sun, its gases cooled, so were even less likely to escape. Just beyond the asteroid belt, a "tipping point" was reached for the larger asteroids.

Thrust Estimates

If gas (or atmospheric) pressure could push a swarm out beyond Neptune, should we expect to see a similar outward movement of Earth? No. Here's why.

Swarms were large. For example, particles 1 AU from the Sun and less than 7,500 miles from the center of the swarm that became Pluto were more attracted gravitationally to the swarm than to the Sun. Therefore, Pluto's swarm, early in its outward spiral, was almost twice ($7,500/4,000 \approx 2$) Earth's diameter, so the swarm intercepted four times ($2^2 = 4$) more solar energy than Earth.

Captured energy is useless unless it is converted to work—in this case outward movement (or thrust). The Carnot efficiency (referred to on page 361) for producing outward thrust of Pluto's slowly spinning swarm was about 15 times greater than that of Earth.¹⁹²

The more massive an object, the less a given force can accelerate it. Earth is 460 times more massive than Pluto. Therefore, Pluto's swarm early in its outward spiral received about 27,600 ($4 \times 15 \times 460 \approx 27,600$) times more outward acceleration from solar energy than Earth. While the outward acceleration on the Earth is too small to be detected (and for most purposes is insignificant), it is some small number *greater than zero*. Soon after the flood, Pluto's outward acceleration would have been 27,600 times greater than that small number. Because displacements grow exponentially over time from accelerations, Pluto and other TNOs moved great distances.

The swarm's gas was cold enough to rarely escape, allowing the Sun's energy to push the swarm farther from the Sun, so the gases were even less likely to escape. Pluto, for example, still has its very cold (-382°F or 43 K) atmosphere.

Third, larger swarms spun more slowly, for the same reason the skater shown on page 154 spins more slowly when her arms are outstretched. The swarm's slower spin made the daylight side hotter, and the night side colder. Greater temperature differences provide greater thrust and efficiency, just as engines produce more power and have greater efficiency if they operate between higher hot temperatures and colder cold temperatures. These effects also added orbital angular momentum as explained in Endnote 23, allowing the swarm to spiral outward beyond the orbit of Neptune. [For details, see: Ralph D. Lorenz and Joseph N. Spitale, "The Yarkovsky Effect as a Heat Engine," *Icarus*, Vol. 170, July 2004, pp. 229–233.] Some TNOs, developed resonances with Neptune as they spiraled out through Neptune's orbit.

Fourth, a swarm also acted as a solar sail. Photons (particles of light) from the Sun transfer their momentum to orbiting

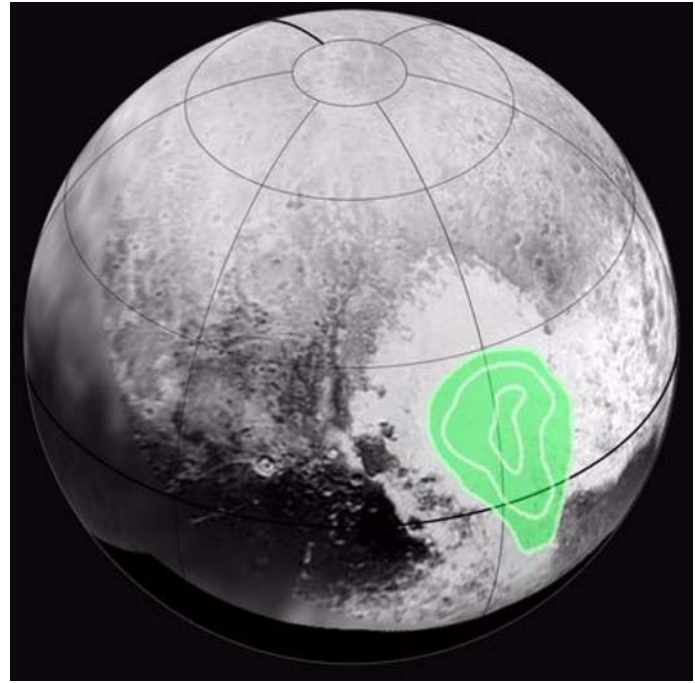

Figure 200: Pluto's Carbon-Monoxide Lake. Why does Pluto have a frozen lake with carbon monoxide ice, shown in green? (The white contours show increased carbon-monoxide concentration near the lake's center.)

First, there must be a large source of carbon, such as

we have in abundance here on Earth. Obviously, vegetation does not grow on Pluto. Next, the carbon compounds must be burned (oxidized), but with a limited supply of oxygen. If plenty of oxygen is available, carbon *dioxide* is produced, not carbon *monoxide*, a poisonous gas. The Sun's radiation would have separated some water vapor from the fountains into oxygen and hydrogen. Water vapor also provided the necessary aerobraking to merge solid materials into comets, asteroids, and TNOs. As solid debris launched by the fountains, including pulverized vegetation from Earth's pre-flood forests, collapsed to become comets, asteroids, and TNOs, great heat was released, especially for Pluto the largest known TNO. That heat then drove the combustion which produced carbon monoxide gas. Eventually, that gas escaped into Pluto's cold atmosphere, instantly became *liquid* carbon monoxide, fell as rain, collected in depressions on Pluto's solid surface (as indicated by the white contour lines above) and quickly froze.

If future astronauts travel to Pluto, they might want to pack their ice skates.

objects they strike. Solar sails are now propelling some spacecraft, and someday may send future spacecraft to a nearby star. Today's solar sails are not much larger than a living-room rug, but a swarm of rocks, ice, and gas would have been thousands of times larger—and provided thousands of times more thrust to steadily accelerate the swarm.

Each individual transfer [of a photon's momentum to a solar sail] amounts to no more than a mosquito's breath, but over time that breath accumulates to a steady wind that a spacecraft can ride just as a sailboat rides the wind on Earth. After 100 days, a solar sail could reach 14,000 kilometers per hour; after three years it could be zipping along at 240,000 kilometers per hour. At that rate it could get to Pluto

*in less than five years, rather than the nine years [normally required using jet propulsion].*¹⁹³

Water-ice on TNOs formed recently in the inner solar system from relatively warm water, so we should not be surprised to find crystalline water-ice on Quaoar and Charon.

After a few years, smaller asteroids lost their gas; 90% of them (those not scattered by gravitational perturbations) settled into the asteroid belt. However, larger asteroids could hang on to their cooling gases which continued to provide thrust by capturing the Sun's energy. They became TNOs. The fountains of the great deep launched rocks, mud, and water. The larger rocks became seeds around which thousands of smaller objects orbited—or swarmed (as a swarm of bees might hover around a beehive). Aerobraking from all the surrounding water vapor slowly and gently merged most of those particles. Those that didn't merge by the time all their gas escaped became moons. (Thus Pluto has five tightly packed moons in chaotic, unstable orbits.) Gaseous drag slowly circularized each swarm's orbit about the Sun and reduced the orbit's angle of inclination, so TNOs not perturbed by a planet as they spiraled out past Neptune ended up in the doughnut-shaped Kuiper Belt.

As you might expect, many swarms, trying to spiral out beyond Neptune, were (1) perturbed by Jupiter, Saturn, Uranus, or Neptune, (2) pulled apart by tidal forces, and (3) given gravity boosts.¹⁹⁴ These bodies, called *centaurs* (after the mythical man/horse creatures) resemble both asteroids and comets. One centaur, Chariklo, has icy rings¹⁵⁸ that appear to be young (a few thousand years old).¹⁵⁹ An estimated 44,000 centaurs are larger than 1 kilometer (0.6 mile). All are unstable, because they cross the orbits of the giant planets and frequently collide with or are ejected from the solar system by those giants. Therefore, centaurs are quite young.

Some asteroids large enough to become TNOs received gravity boosts from the giant planets. Because those gravity boost began near the ecliptic, ω was either near 0° (if the TNO was boosted above—north of—the ecliptic), or 180° (if the boost flung the asteroid below the ecliptic). Approximately 5,000 years of perturbations have modified these orbits to some extent, but not enough to erase the $\omega \approx 0^\circ$ or 180° signature that Dr. R. Brown discovered for all TNOs taken as a group. Certainly, millions of years of perturbations would have randomized the ω values.

Pluto's Towering Mountains and a Carbon-Monoxide Lake. As explained in [Figure 197 on page 360](#), the swarm that collapsed to form Pluto (the largest known TNO) probably generated more heat producing impacts than any other TNOs. That rapid internal heating would have partially “burned” (or oxidized) vegetation incorporated into Pluto from the debris launched from Earth's pre-flood forests by the fountains of the great deep. Water (H_2O)

supplied limited amounts of oxygen (O). Carbon monoxide (CO), normally a low density gas, is produced by the partial oxidation of carbon compounds. However, once that gas escaped during the eruptions into Pluto's extremely cold atmosphere, it liquefied, fell as rain, collected in surface depressions, and quickly froze as carbon-monoxide lakes. Carbon monoxide gas at atmospheric pressures here on Earth liquefies at $-313^\circ F$ and solidifies at $-337^\circ F$, but Pluto's atmosphere is an even colder $-382^\circ F$.

Methane (CH_4) and Life on Pluto. Pluto's atmosphere contains methane. On Earth, bacteria produce 90–95% of all methane.¹⁹⁵ Did bacteria produce methane on Pluto?

If pulverized vegetation launched by the fountains of the great deep was incorporated into Pluto, as indicated above by the carbon-monoxide lake, then bacteria would have been attached. Bacteria, with their food supply (vegetation), would have been prolific producers of methane. Some bacteria would not have survived Pluto's harsh conditions, but those that did had more food and thus reproduced their kind more abundantly.

Because methane has been reported on Mars, many scientists suspect that bacteria are on Mars. However, in rare cases, methane, can be produced when *liquid* water interacts with certain rocks. Although liquid water may be inside Mars where conditions are warmer, that possibility does not apply to Pluto, where temperatures are so cold there should be no *liquid* water on or inside Pluto to produce methane. Therefore, Pluto's methane is probably from bacterial life—life that came from Earth!

All the giant planets and some moons and comets have methane in their atmospheres, so—for the same reasons—they may have (or had) life in the form of bacteria.

The Evolution of the Solar System Theory. From an evolutionist's perspective, Sedna, 2012 VP₁₁₃, and the other ten distant and highly eccentric TNOs should not be where they are—far beyond the Kuiper Belt and the outer edge of the solar system.

*To all intents and purposes, in the current architecture of the Solar System, Sedna and 2012 VP113 should not be there. These objects are in a no-man's-land between the giant planets and the [hypothetical] Oort cloud where nothing in the known configuration of the modern day Solar System could have emplaced them.*¹⁹⁶

Two astronomers (Konstantin Batygin and Mike Brown, both at California Institute of Technology), grasping at straws to solve this problem, announced on 20 January 2016, through most media outlets in the world, that a planet nearly the size of Neptune must orbit the Sun seven times farther out than Neptune (over 200 AU from the Sun). They said that the gravity of this predicted planet has pulled six of these

twelve TNOs into their elongated, extremely distant orbits, and telescopes will find this Planet X by January 2021.¹⁹⁷

These astronomers are unaware of the mechanism that produced all twelve (not just six) of these extremely distant, highly eccentric and inclined TNOs. Therefore, Evolution theories do not explain how the tens of thousands of TNOs formed.



PREDICTION 51: Planet X will not be found in the next 5 years (by January 2021), because it does not exist.

Table 20. Origin of Trans-Neptunian Objects (TNOs)

		Theories	
		Hydroplate Theory	Evolution of Solar System
Evidence to be Explained	Mechanism for Forming TNOs	●	⊗
	Moons of TNOs	●	⊗
	Pluto's Young Moons	●	●
	Young Pluto	●	⊗
	Bacterial Life on Pluto	●	⊗
	Pluto's Mountains and Polygons	●	⊗
	Nearly Identical Values for ω	●	⊗
	Twelve Extremely Distant TNOs	●	●
	ω Clustering for 1600 TNOs	●	⊗
	Resonances	●	●
	Young Centaurs	●	⊗
	Trojan Asteroids at Jupiter's L4 and L5	●	⊗
	Rings	●	⊗
	Low Density	●	●
	Crystalline Water-Ice	●	⊗
	Redness	●	●
Wide Binaries	●	⊗	

Key: ● Explained by theory.
 ● Theory has moderate problem with this item.
 ⊗ Theory has serious problems with this item.

Pluto may be the most famous resident of this frozen [TNO] netherworld, but other objects in this sparsely populated region stand out for their bewildering variety of shapes, colors, densities and orbits. ...

*Astronomers don't yet have a complete picture of the Kuiper Belt, and new riddles ...*¹⁹⁸

Evaluation of Evidences vs. Theories. Table 20 compares these two competing theories. My subjective judgments are coded in green, yellow, and red circles, similar to what is seen in other chapters. You are encouraged to make

your own evaluation using either the above information or other available sources.

Final Thoughts

As with the 24 other features listed on page 111, we have examined the origin of asteroids, meteoroids, and TNOs from two directions: “cause-to-effect” and “effect-to-cause.”

Cause-to-Effect. Given the three assumptions listed on page 124, consequences naturally followed: subterranean water became supercritical, the fountains of the great deep erupted; large rocks, muddy water, and water vapor were launched into space; gravity and gas assembled asteroids; and gas pressure powered by the Sun's energy (the radiometer effect) herded most small asteroids into the asteroid belt and large asteroids out beyond Neptune. Isolated rocks, still moving in the solar system, are meteoroids.

Effect-to-Cause. We considered twenty-one effects (pages 344–352), each incompatible with present theories on the origin of asteroids and meteoroids. Each effect was evidence that large volumes of rocks and water vapor were launched from Earth.

Working both from cause-to-effect and effect-to-cause is similar to untangling a large ball of twisted and knotted string. Progress is faster when both ends of the string can be used. Too often in science we use only “one end.”

Portions of Part III will examine this global flood from a third direction: historical records from claimed eyewitnesses. All three perspectives reinforce each other, illuminating in different ways this catastrophic event. But first, we must understand where all the energy came from that launched all the fountains of the great deep. That will be the subject of the next chapter, “**The Origin of Earth's Radioactivity**.”

References and Notes

1. “About 16% of near-Earth asteroids larger than 200 meters in diameter [those detected by Earth-based radar] may be binary systems.” J. L. Margot, “Binary Asteroids in the Near-Earth Object Populations,” *Science*, Vol. 296, 24 May 2002, p. 1445.
 ♦ www.johnstonsarchive.net/astro/asteroidmoons.html
2. D. T. Britt et al., “Asteroid Density, Porosity, and Structure,” *Asteroids III*, editors W. F. Bottke et al. (Tucson, Arizona: University of Arizona Press, 2002), pp. 485–500.
3. www.minorplanetcenter.org/iau/MPCORB.html
4. “A common misconception is that asteroids are the remains of a large planet that mysteriously exploded long ago. Today there is hardly enough material in the asteroid belt to make a

small moon.” Derek C. Richardson, “Giants in the Asteroid Belt,” *Nature*, Vol. 411, 21 June 2001, p. 899.

5. Jupiter’s gravity is often given as a simplistic reason a planet did not form. If that were true, why didn’t Jupiter prevent even dust or the tiniest grains of sand from forming big rocks? Actually, Jupiter’s gravity flings asteroids from the asteroid belt at a rate that is rapid relative to the evolutionist’s age for the solar system—4,600,000,000 years.
 - ◆ One of the big problems in the current story on how asteroids evolved is: “How do gas and dust in a hypothetical solar nebula condense into dense boulders (asteroids, planetesimals, and meteoroids)?” As one expert on meteorites admitted, “*even Earth’s most evolved brains still haven’t grasped why space dust condensed into boulders.*” William Speed Weed, “Philip Bland: Meteor Man,” *Discover*, Vol. 22, March 2001, p. 46.
6. “*Although Jovian perturbations are widely invoked to explain [why asteroids failed to grow to become planets in] the asteroid belt, the precise mechanism that halted planet formation is still a subject of some dispute.*” Jack J. Lissauer and Glen R. Stewart, “Growth of Planets from Planetesimals,” *Protostars and Planets III*, editors Eugene H. Levy and Jonathan I. Luine (London: The University of Arizona Press, 1993), pp. 1080–1081.

These authors then explain why the several explanations proposed are unsatisfactory.
7. “*The predicted mean time between major asteroid collisions [for each asteroid] is about 5% of the age of the solar system. All asteroids should already be highly fragmented unless their origin is relatively recent, as in the exploded planet theory.*” Tom C. Van Flandern, *Dark Matter, Missing Planets and New Comets* (Berkeley, California: North Atlantic Books, 1993), p. 216.
8. The estimated mass of all asteroids (excluding TNOs) is 2.6×10^{24} grams. For a fuller discussion of the mass launched, see page 597.
9. “*Here we report the detection of water vapour around Ceres, with at least 10^{26} molecules being produced per second, [13 pounds/sec] originating from localized sources that seem to be linked to mid-latitude regions on the surface.*” Michael Kuppers et al., “Localized Sources of Water Vapour on the Dwarf Planet (1) Ceres,” *Nature*, Vol. 505, 23 January 2014, p. 525.
10. “*... Ceres is a partially differentiated body, with a rocky core overlaid by a volatile-rich shell.*” R. S. Park et al. “A Partially Differentiated Interior for (1) Ceres Deduced from its Gravity Field and Shape,” *Nature*, Vol. 537, 22 September 2016, p. 515.
11. “*But it was the components of the cliffs and pits that caught Sierks’ eye. Embedded along their edges are strange spheres, most between 1 and 3 meters in diameter.*” Andrew Grant, “Comet May Expose Its Building Blocks,” *Science News*, Vol. 187, 10 January 2015, p. 8.
 - ◆ “*The researchers described three-meter-wide pebble-like features that are found all over the comet, which they nicknamed*

‘goosebumps.’ Elizabeth Gibney, “Philae Hunt Hangs in the Balance,” *Nature*, Vol. 517, 29 January 2015, p. 537.

- ◆ “*In the walls of other pits, OSIRIS [Rosetta’s powerful camera] has spotted what could be features dating back to the comet’s formation: what the team calls ‘goosebumps’ or ‘dinosaur eggs,’ nodules about 3 meters across that could represent the fundamental chunks of material that coalesced into 67P.*” Eric Hand, “Comet Close-up Reveals a World of Surprises,” *Science*, Vol. 347, 23 January 2015, p. 358.
 - ◆ Eric Hand, “‘Dinosaur Eggs’ Spotted on Rosetta’s Comet,” *Science Online*, 18 December 2014.
12. Erik Asphaug, “The Small Planets,” *Scientific American*, Vol. 282, May 2000, p. 48.
 13. Some of this water vapor also condensed as frost in permanently shadowed craters on the Moon, Mercury, and Mars.
 14. Some asteroids, called C-type asteroids, are darker than coal! They typically lie in the outer part of the asteroid belt. Lighter-colored, S-type asteroids are generally in the inner part of the belt. Darker asteroids (which both absorb and radiate heat more efficiently) have both hotter hot sides and colder cold sides. [See [Figure 183](#).] Those greater temperature differences produced greater thrust, which moved C-type asteroids farther from the Sun.
 15. The size, shape, and inclination of a body’s orbital path around the Sun is described by three numbers:
 - a (the semimajor axis or size of the orbit),
 - e (the eccentricity or shape of the orbit), and
 - i (the inclination or tilt of the orbital plane with respect to Earth’s orbital plane).

In other words, in a special three-dimensional coordinate system (a, e, and i), each of a thousand scattered points represented an asteroid starting out on a different orbit from some point on Earth’s orbit.

The forces that acted on asteroids were gravity, drag, and thrust. (Today, drag and thrust are zero.) Although gravity is easy to model, it is virtually impossible to determine what the drag and thrust were and how they diminished in the years after the flood, because experimentally determined relationships are involved. Also, *the amount of water vapor placed in orbit may never be known—even approximately.* However, drag and thrust can be described with just a few simplifying parameters. (For example, drag is equal to some parameter times velocity squared. That parameter depends on several unknowns, including the density of water vapor which diminishes over time according to a second parameter.)

By fine tuning the parameters for drag and thrust and then simulating the changing orbits as time progressed, I could watch on a computer monitor all those scattered points simultaneously migrate toward the single point (a = 2.8 AU, e = 0, i = 0) representing today’s asteroid belt.

While these functional relationships for drag and thrust are not derivable, they are consistent with the way drag and thrust generally act. It was remarkable that with only a few parameters, nearly an infinite number of scattered points

- could be “mapped” almost into one point: ($a = 2.8$ AU, $e = 0$, $i = 0$). In physical terms, almost all simulated asteroids, regardless of their initial orbit somewhere in the inner solar system, slowly migrated into the asteroid belt.
16. For simplified explanations, see
 - ❖ Philip Gibbs, “How Does a Light Mill Work?” 1996 at <http://johanw.home.xs4all.nl/PhysFAQ/General/LightMill/light-mill.html>
 - ❖ Arthur E. Woodruff, “The Radiometer and How it Does Not Work,” *The Physics Teacher*, October 1968, pp. 358–363.
 17. “*In particular, nanotechnology [many small hot edges] could permit for an enhancement of the [radiometer] force by a factor of 10^7 ...*” Marco Scandurra, “Enhanced Radiometric Forces,” 2 February 2008, <http://arxiv.org/pdf/physics/0402011.pdf>, p. 8.
 18. “[‘Goosebumps’] *are seen on very steep slopes and on exposed cliff faces, but their formation mechanism is yet to be explained.*” ESA/Rosetta/MPS for OSIRIS Team MPS/UPD/LAM/IAA/SSO/INTA/UPM/DASP/IDA
 - ◆ “*The images [taken of comet 67P] revealed ... boulders measuring up to tens of meters, and outlines of near-circular objects about which little is clearly understood.*” ESA/Rosetta/NavCam, 19 February 2015.
 - ◆ “*The boulder-like structures that Rosetta has revealed in many places on the surface of 67P/C-G are one of the comet’s most striking and mysterious features.*” Jet Propulsion Laboratory, Press Release, 19 February 2015.
 19. “*Five of the numbered periodic comets are in fact also listed alternatively as numbered minor planets.*” Brian G. Marsden and Gareth V. Williams, *Catalogue of Cometary Orbits*, 17th edition (Cambridge, Massachusetts: Minor Planet Center, 2008), p. 6.
 - ◆ “*Since 2006, however, nine bodies orbiting within the main asteroid belt have been found with physical characteristics similar to comets;*” Kristen Mueller and Jake Yeston, “Impulsive Activity,” *Science*, Vol. 338, 14 December 2012, p. 1397.
 20. O. Richard Norton, *The Cambridge Encyclopedia of Meteorites* (Cambridge, United Kingdom: Cambridge University Press, 2002), p. 186.
 21. This may seem counterintuitive, since the pull of gravity on an asteroid is so much less than that of Earth. A particle will slip or roll on any inclined surface if the pushing force exceeds the resisting force holding the particle in place. Both forces are proportional to the local gravity, so the “*angle of repose*,” even on an asteroid, is still about 30 degrees.
 22. Sunlight would quickly break down a free water molecule into hydroxyl (OH) and atomic hydrogen (H). Other gases would also be present.
 23. As explained in Figure 181 on page 338, asteroids typically have Earthlike spin rates. The hottest “time of day” on a spinning asteroid was not “high noon,” but “several hours after noon,” as it is on Earth. Therefore, the thrust acting on asteroids had a tangential component as well as a radial component. The tangential component steadily added angular momentum to each asteroid’s orbit, allowing it to spiral outward.
 24. Consider two gravitational forces acting on a mass, m , at the Earth’s surface. The first, F_E , is caused by the Earth’s mass, M_E , acting, in effect, from the Earth’s center—a distance D_E (4,000 miles) away. The second gravitational force, F_S , is caused by the Sun’s mass, M_S , acting from a distance of D_S (93,000,000 miles). Letting G be the gravitational constant, these forces are:

$$F_E = \frac{G M_E m}{D_E^2} \quad \text{and} \quad F_S = \frac{G M_S m}{D_S^2}$$

The Sun is 332,900 times more massive than Earth. Dividing the left equation by the right gives:

$$\frac{F_E}{F_S} = \frac{M_E}{M_S} \times \left(\frac{D_S}{D_E} \right)^2 = \frac{1}{332,900} \times \left(\frac{93,000,000}{4,000} \right)^2 = 1,600$$

This means that a steady, 1-pound force could *lift and accelerate* a rock away from the Sun if the rock weighed 1,600 pounds on Earth and the rock were more than 93,000,000 miles above the Sun and far from Earth.
 25. Temperatures probably reached 3,000°F (1,650°C). [See “**Chondrules**” on page 410.] If so, as temperatures steadily rose, quartz would have been the first major mineral in granite to melt. Much of it would have dissolved in the hot, subterranean water.
 26. Claims are sometimes made that radioactive decay generated the heat, but standard calculations that would support those speculations are never shown.
 27. “... *we lack compelling scenarios leading to the origin of iron meteorites ... Early solar system collisions have been called upon to excavate this iron [from the cores of the largest asteroids], although numerical impact models have found this task difficult to achieve, particularly when it is required to occur many dozens of times, yet not a single time for asteroid Vesta.*” Erik Asphaug et al., “Tides Versus Collisions in the Primordial Main Belt,” October 2000, www.aas.org/publications/baas/v32n3/dps2000/545.htm.
 28. “[NASA’s model] *predicts a dust concentration in the asteroid belt about an order of magnitude higher than the dust density near Earth.*” J. S. Dohnanyi, “Sources of Interplanetary Dust: Asteroids,” *Interplanetary Dust and Zodiacal Light*, editors H. Elsässer and H. Fechtig (New York: Springer-Verlag, 1976), p. 189.
 29. J. M. Alvarez, “The Cosmic Dust Environment at Earth, Jupiter and Interplanetary Space: Results from Langley Experiments on MTS, Pioneer 10 and 11,” *Ibid.*, p. 181.
 - ◆ “*It can be seen, Fig. 2, that the number density of interplanetary dust inferred from the penetration data is a slowly decreasing function with heliocentric distance [R] ... a distribution that varies as R^{-1} [for 1 AU < R < 4 AU].*” Dohnanyi, p. 190.

30. Kazushige Tomeoka, "Phyllosilicate Veins in a CI Meteorite: Evidence for Aqueous Alteration on the Parent Body," *Nature*, Vol. 345, 10 May 1990, pp. 138–140.
31. *"Eros, indeed, has no detectable magnetic field. That's puzzling because meteorites, which are believed to be fragments of asteroids, possess magnetic fields. How could a chip of an asteroid be magnetic if the parent asteroid isn't?"* Ron Cowen, "Asteroid Eros Poses a Magnetic Puzzle," *Science News*, Vol. 159, 2 June 2001, p. 341.
32. Olivine is a class of minerals that includes perhaps half the minerals in the Earth's crust and upper mantle. Olivine consists of tiny tetrahedra (three-sided pyramids), each composed of a silicon atom surrounded by four oxygen atoms at the pyramid's corners. The pyramids are tightly stacked together and further strengthened by iron and/or magnesium atoms that fit snugly between the pyramids. In pallasites, the olivine is strictly the magnesium variety, a mineral called *forsterite*.
- At atmospheric pressure, forsterite melts at almost 1900°F, one of the highest melting temperatures of all minerals. The iron variety of olivine, called *fayalite*, melts at about 1200°F. An iron-nickel mixture melts at about 1300°F. Deep in the Earth, pressures are greater, so melting temperatures are somewhat higher, depending on depth.
- The fluttering hydroplates and pounding pillars crushed rock and generated frictional heat along the sliding surfaces. Near those surfaces, minerals that had low melting temperatures, including minerals containing iron and nickel, melted quickly. The dense iron and nickel drained down cracks and displaced upward melted material that was less dense. Even after the large rocks were launched and cooling had begun on their outside surfaces, the extremely hot molten material deep inside the rocks continued to melt other minerals. Before forsterite could melt, the molten iron-nickel steadily froze while forsterite crystals were suspended in a weightless environment within the melt. Pallasites formed.
- Notice in Figure 187 that the forsterite crystals are of similar size and uniformly distributed. This is because each microscopic pyramid, drifting weightlessly in the iron-nickel "soup," had unbalanced electrical charges which pulled nearby pyramids together into a crystalline arrangement.
33. Why could almost no one have imagined this energy source? They visualized phenomena by reasoning only from effects we see today back to possible causes. Had they also reasoned from cause to effect—from water in a subterranean chamber to its consequences (such as tidal pumping producing supercritical water)—they might have realized that large rocks would have been launched from Earth during the flood.
34. *"These three different techniques show the MG [main group] pallasites cooled below 975 K at significantly diverse rates. Since samples from the core-mantle boundary should have indistinguishable cooling rates, MG pallasites could not have cooled at this location."* Jijin Yang et al., "Main-Group Pallasites: Thermal History, Relationship to IIIAB Irons, and Origin," *Geochimica et Cosmochimica Acta*, Vol. 74, 2010, p. 4471.
35. *"These pallasites record substantial magnetic fields, with intensities ranging up to nearly twice that of Earth today."* Benjamin P. Weiss, "A Vitrage of Asteroid Magnetism," *Science*, Vol. 338, 16 November 2012, p. 898.
- ◆ James F. J. Bryson et al., "Long-Lived Magnetism from Solidification-Driven Convection on the Pallasite Parent Body," *Nature*, Vol. 517, 22 January 2015, pp. 472–475.
36. Alan E. Rubin, "What Heated the Asteroids," *Scientific American*, Vol. 292, May 2005, pp. 80–87.
37. The following concerns Vesta, the second-most-massive asteroid, whose mean diameter is 326 miles (525 kilometers).
- "Spectroscopic observations of Vesta's surface indicate that it is covered with volcanic basalt, leading researchers to conclude that Vesta's interior once melted. The cause of the heating cannot be long-lived radioisotopes; given the primordial concentrations of the isotopes and the expected rate of heat loss, calculations show that the radioactive decay could not have melted Vesta or any other asteroid. Another heating mechanism must therefore be responsible, but what is it? This question has dogged planetary scientists for decades."*
- Alan E. Rubin, "What Heated the Asteroids," *Scientific American*, Vol. 292, May 2005, p. 82.
- "It is thus clear that many asteroids were once quite hot. But what mechanism could have raised the temperatures of the asteroids to this extent if the rocky bodies were too small to retain the heat from long-lived radioisotopes?"* Ibid., p. 84.
38. *"However, up until recently, the general paradigm has been that asteroids are 'rocky,' inner-solar system objects and comets are 'icy' outer-solar system objects. A number of recent observations and models have significantly muddied the waters (so to speak). While ice is not found at the surface of Ceres [the largest of all asteroids], there is evidence [the low density of Ceres] that a large ice ocean is present in its subsurface ..."*
- A. S. Rivkin and J. P. Emery, "Water Ice on 24 Themis?" 2008. www.lpi.usra.edu/meetings/acm2008/pdf/8099.pdf
39. *"We conclude that [asteroid] 65 Cybele is covered by fine anhydrous silicate grains, with a small amount of water-ice and complex organic solids."* Zoe Landsman et al., "Asteroid 65 Cybele: Detection of Small Silicate Grains, Water-Ice and Organics," *Bulletin of the American Astronomical Society*, Vol. 42, 2010, p. 1035.
- ◆ Humberto Campins et al., "Water Ice and Organics on the Surface of the Asteroid 24 Themis," *Nature*, Vol. 464, 29 April 2010, pp. 1320–1321.
 - ◆ Andrew S. Rivkin and Joshua P. Emery, "Detection of Ice and Organics on an Asteroidal Surface," *Nature*, Vol. 464, 29 April 2010, pp. 1322–1323.
40. *"The surprise is the wide extent of ice on the surface of Themis. The average temperature of asteroids (about 150–200 kelvin) [-100°F to -190°F] at this distance from the Sun should cause surface ice to sublimate away in a matter of a few years or less, which is inconsistent with the billions of years that Themis is thought to have spent at its current location."* Henry H. Hsieh, "A Frosty Finding," *Nature*, Vol. 464, 29 April 2010, p. 1286.

41. "Meteorites and probably all meteoroids contain the same materials as those contained in the Earth itself." Franklyn M. Branley, *Comets, Meteoroids, and Asteroids: Mavericks of the Solar System* (New York: Thomas Y. Crowell, 1974), p. 38.
- ◆ "Modern mass spectrometry techniques had revealed that the isotopic compositions of many of the more refractory elements in meteorites, including a primitive class of meteorite called chondrites, are, within error, identical to those found on Earth itself." Alex N. Halliday, "Inside the Cosmic Blender," *Nature*, Vol. 425, 11 September 2003, p. 137.
 - ◆ "The thousands of meteorites that strike the earth each year are generally believed to be either fragments of a disrupted planet (or planets) that originally resembled the earth, or bits of cosmic "dust" such as originally were gathered together to form the earth." Gordon A. Macdonald et al., *Volcanoes in the Sea*, 2nd edition (Honolulu: University of Hawaii Press, 1983), p. 325.
42. W. J. Merline et al., "Discovery of a Moon Orbiting the Asteroid 45 Eugenia," *Nature*, Vol. 401, 7 October 1999, pp. 565–568.
43. Some have claimed that mining asteroids could be profitable. [See John S. Lewis, *Mining the Sky: Untold Riches from the Asteroids, Comets, and Planets* (Reading, Massachusetts: Addison-Wesley, 1997).]
44. Besides iron meteorites, which were once 1,300°F, chondrules were once about 3,000°F. [See page 410 and Figure 185 on page 341.] Also, the matrix material encasing chondrules shows thermal metamorphism requiring temperatures of at least 750°F. [See O. Richard Norton, *The Cambridge Encyclopedia of Meteorites* (Cambridge, England: Cambridge University Press, 2002), p. 92.]
45. "The water content (by weight) of the meteorites is about 11 percent for type 1 chondrites, about 9 percent for type 2, and 2 percent or less for type 3." *Ibid.*, p. 83.
46. "... every metamorphosed ordinary chondrite has been shocked and subsequently heated, some of them multiple times." *Ibid.*, p. 86.
47. "First, a single impact cannot raise the global temperature of an asteroid-size body by more than a few degrees. Second, the high surface-to-volume ratios of such bodies promote heat loss, so they cool quickly between successive impacts. Third, a typical impact generates minuscule amounts of melted rock relative to the volume of the impact-generated debris. And last, the low escape velocities of asteroids allow much of the most strongly heated material to escape." *Ibid.*, p. 86.
48. "Diamonds were first found in this meteorite type [ureilites]." Norton, p. 347.
- ◆ Farhang Nabiei, "Diamonds from a Lost Planet." *Nature*, Vol. 556, 26 April 2018, p. 411.

While Farhang Nabiei correctly concludes that this diamond-containing meteorite must have come from deep inside a "shattered" planet-size body near Earth, he cannot imagine where that planet is today. Therefore, he writes that it has

"vanished" and the meteorite must have been launched "during the first million years of the Solar System's history."

49. Tristan Ferroir et al., "Carbon Polymorphism in Shocked Meteorites: Evidence for New Natural Ultrahard Phases," *Earth and Planetary Science Letters*, Vol. 290, 15 February 2010, pp. 150–154.
50. The following prediction was made on page 222 of the 7th edition of *In the Beginning*.

Ceres, the largest asteroid, will be found to have a very earthlike spin.

It is now known that Ceres rotates once every 9.075 hours but its spin axis deviates only 3° from being perpendicular to the Earth's orbital plane. I expected 0°. [See P. C. Thomas et al., p. 224.] The Earth rotates once every 23.93 hours. This prediction missed the mark more than I expected.

I selected Ceres because it is the most massive asteroid, having about 1.28% of the mass of the Moon. Therefore, Ceres is least likely to have its spin rate and spin axis altered much by the inevitable impacts within the asteroid belt.

51. Most astronomers mistakenly visualize moons of asteroids forming from an impact. Small "chips" might be expelled, but only in extremely rare circumstances would they be placed in orbit around the asteroid by the gravitational attraction of other debris. For example:

What was particularly surprising was that it [asteroid Hermes] was binary with equal components. Jean-Luc Margot, as quoted by K. Ramsayer, "Out of Hiding," *Science News*, Vol. 164, 1 November 2003, p. 277.

- ◆ "I'm stunned and astonished [at seeing a double asteroid]." Planetary physicist Jay Melosh, as quoted by Richard A. Kerr, "Double Asteroid Puzzles Astronomers," *ScienceNOW*, 21 September 2000.
52. "...Octor Crater—in which nestle bright patches of salt deposits." Phillip Campbell, "Closer Look at Ceres," *Nature*, Vol. 558, 7 June 2018, p. 10.
53. A. Nathues et al., "Sublimation in Bright Spots on (1) Ceres," *Nature*, Vol. 528, 10 December 2015, pp. 237–240.
54. R. P. Binzel and T. C. Van Flandern, "Binary Asteroids: Evidence for Their Existence from Lightcurves," *Science*, Vol. 203, 2 March 1979, pp. 903–905.
55. "The most primitive meteorites, the carbonaceous chondrites, are primarily mixtures of many distinct materials that reflect a variety of solar nebular environments as well as planetary processing." Qingzhu Yin et al., "Diverse Supernova Sources of Pre-Solar Material Inferred from Molybdenum Isotopes in Meteorites," *Nature*, Vol. 415, 21 February 2002, p. 881.

Why do they say "a variety of solar nebular environments"? Had the solar system and the molybdenum isotopes found in meteorites come from the debris of one exploded star and millions of years of mixing, these different isotopes should be spread somewhat uniformly in meteorites. They are not. Therefore, many exploding stars are needed. Furthermore, evolutionists must maintain that molybdenum isotopes

avoided mixing for millions of years. Every statistician knows that with enough variables (in this case, enough stars exploding in different ways for millions of years), many untestable explanations can be proposed.

56. The smaller, asteroid-size moons of the giant planets tend to have irregular orbits. [See Table 21.] For example, Jupiter has at least 31 irregular moons, the largest, Himalia, is 150 kilometers (93 miles) in diameter. Their orbits generally have high inclinations and large eccentricities. Astronomers don't understand why so many are retrograde.

Table 21. So Many “Remarkable” Orbits

Planet	Moon	Orbital Eccentricity	Orbital Inclination (with planet's equator)
Mars	Deimos	0.0005	1.80°
	Phobos	0.015	1.09°
Jupiter	Io	0.004	0.04°
	Europa	0.009	0.47°
	Ganymede	0.002	0.17°
	Callisto	0.007	0.51°
	Amalthea	0.003	0.40°
Saturn	Mimas	0.020	1.56°
	Enceladus	0.005	0.03°
	Tethys	0.000	1.10°
	Dione	0.002	0.02°
	Rhea	0.000	0.35°
	Titan	0.029	0.30°
	Hyperion	0.103	0.64°
	Phoebe	0.1633	177.2°
	Janus	0.007	0.16°
	Epimetheus	0.010	0.35°
	Helene	0.000	0.21°
	Telesto	0.001	0.00°
	Calypso	0.001	1.16°
	Atlas	0.002	1.47°
	Prometheus	0.002	0.30°
Pandora	0.004	0.00°	
Pan	0.000	0.00°	
Uranus	Ariel	0.003	0.30°
	Umbriel	0.005	0.36°
	Titania	0.002	0.14°
	Oberon	0.001	0.10°
	Cordelia	0.000	0.08°
	Ophelia	0.010	0.10°
	Bianca	0.010	0.19°
	Desdemona	0.000	0.11°
	Juliet	0.001	0.06°
	Portia	0.000	0.09°
	Rosalind	0.000	0.28°
Berlinda	0.000	0.03°	
Puck	0.000	0.31°	
Neptune	Despina	0.000	0.07°
	Galatea	0.000	0.05°
	Larissa	0.001	0.20°
	Proteus	0.000	0.04°

“Irregular satellites of planets in the outer Solar System are the only population of objects dominated

by retrograde motion relative to the parent body, but their origin is not clear.” Paul A. Wiegert et al., “A Retrograde Co-Orbital Asteroid of Jupiter,” *Nature*, Vol. 543, 30 March 2017, p. 687.

These characteristics show they were captured. To capture an asteroid, much of its orbital energy must be removed (or dissipated), so the planet's gravity can hold onto the asteroid. Captures rarely result from chance gravitational encounters with other large bodies. An easy way to dissipate an asteroid's energy is by *aerobraking*: friction with an atmosphere—the planet's, the asteroid's, or both. Based on the hydroplate theory, bloated atmospheres existed for a few centuries after the flood, so the key evidence for these captures is absent today. However, dozens of other evidences are now available, all pointing to the fountains of the great deep.

- ◆ Enceladus Sea,” *Science*, Vol. 344, 4 April 2014, p. 17.
- 57. “[German scientists] reported the clear detection of sodium in [Saturn's] E ring's ice particles. Six percent of the particles are rich in sodium and contain salts such as sodium chloride and sodium bicarbonate, along with smaller amounts of potassium. Cassini has traced the ice grains to a towering plume rising from Enceladus's south pole. ... The salts—resembling terrestrial [Earth] sea salt ...” Richard A. Kerr, “Tang Hints of a Watery Interior for Enceladus,” *Science*, Vol. 323, 23 January 2009, pp. 458–459.
- ◆ “... although all the [ice] grains are dominated by water ice, about 6% of them are quite salty, containing roughly 1.5% of a mixture of sodium chloride, sodium carbonate and sodium bicarbonate.” John Spencer, “Enceladus with a Grain of Salt,” *Nature*, Vol. 459, 25 June 2009, p. 1067.
- ◆ Frank Postberg et al., “Sodium Salts in E-Ring Ice Grains from an Ocean below the Surface of Enceladus,” *Nature*, Vol. 459, 25 June 2009, p. 1098–1101.
- ◆ Frank Postberg et al., “A Salt-Water Reservoir as the Source of a Compositionally Stratified Plume on Enceladus,” *Nature*, Vol. 474, 30 June 2011, pp. 620–622.
- 58. M. M. Hedman et al., “An Observed Correlation between Plume Activity and Tidal Stresses on Enceladus,” *Nature*, Vol. 500, 8 August 2013, pp. 182–189.]
- ◆ Richard A. Kerr, “Cassini Plumbs the Depths of the Margaret Galland Kivelson, “Does Enceladus Govern Magnetospheric Dynamics at Saturn?” *Science*, Vol. 311, 10 March 2006, pp. 1391–1392.
- ◆ The temperature in Enceladus' subglacial ocean is greater than 194°F (>90°C). [See Hsiang-Wen Hsu et al., “Ongoing Hydrothermal Activities within Enceladus,” *Nature*, Vol. 519, 12 March 2015, pp. 207–210.]
- ◆ “...this icy moon's sizzling innards are not easily explained. Enceladus is roughly the diameter of England—relatively runty for a moon and far too small to hold onto the primordial heat left over from its formation.” Postberg, Frank, et al., “Under the Sea of Enceladus,” *Scientific American*, Vol. 315, October 2016, p. 40.

- ◆ “Scientists do not yet know exactly how the tiny moon generates enough heat to sustain this large ocean.” Ibid., p. 43.
 - ◆ “...the geysers [on Enceladus] spurt out 200 kilograms of salty, organic-laced material every second.” Alexandra Witze, “13 Years of Cassini,” *Nature*, Vol. 548, 31 August 2017, p. 513.
59. Paul Schenk and the Cassini Imaging Team, <http://apod.nasa.gov/apod/ap080331.html>, 31 March 2008.
 60. “Beneath an icy crust, Saturn’s moon Enceladus has an ocean that covers its entire globe.” Peter Thomas, “Global Ocean on Enceladus,” *Nature*, Vol. 525, 24 September 2015, p. 428.
 - ◆ The plume escaping from Enceladus contains methane (CH₄) and a smattering of other organics, such as propane (C₃H₈), ethane (C₂H₆), benzene (C₆H₆), and formaldehyde (CH₂O). [See Porco, p. 58.] To understand their likely origin, see pages 111–151.
 61. “At present it is practically impossible for Jupiter to capture satellites permanently because no efficient dissipation mechanism exists.” Scott S. Sheppard and David C. Jewitt, “An Abundant Population of Small Irregular Satellites Around Jupiter,” *Nature*, Vol. 423, 15 May 2003, p. 261.
 62. Joanne Baker, “Tiger, Tiger, Burning Bright,” *Science*, Vol. 311, 10 March 2006, p. 1388.
 63. Frank Postberg, et. al., “Macromolecular Organic Compounds From the Depths of Enceladus,” *Nature*, Vol. 558, 28 June, 2018, p. 564.
 64. “Finding such active geology on such a tiny moon is a big surprise. ... tiny Enceladus produces a plume large enough to drench the whole Saturn system. The origin of Enceladus’ internal heating is also still a major puzzle.” Baker, p. 1388.
 - ◆ “Enceladus has been found to be one of the most geologically dynamic objects in the solar system. Among the surprises are a watery, gaseous plume; a south polar hot spot; and a surface marked by deep canyons and thick flows.” Jeffrey S. Kargel, Enceladus: Cosmic Gymnast, Volatile Miniworld,” *Science*, Vol. 311, 10 March 2006, p. 1389.
 - ◆ Ten other papers in the 10 March 2006 issue of *Science*, pages 1391–1428, report on these observations from the Cassini spacecraft.
 65. “... the amount of tidal energy being injected into [Enceladus today] falls short of the energy coming out of Enceladus’ south pole by a factor of five.” Carolyn Porco, “The Restless Worlds of Enceladus,” *Scientific American*, Vol. 299, December 2008, p. 60.
 66. “Global -ocean models have fallen out of favour for Enceladus, because it is difficult to keep a global ocean from freezing, and a regional south polar ocean is now considered more likely.” John Spencer, “Saturn’s Tides Control Enceladus’ Plume,” *Nature*, Vol. 500, 8 August 2013, p. 156.
 67. “Ocean on Another of Saturn’s Moons,” *Nature*, Vol. 538, 13 October 2016, p. 143.
 68. “The interior of Mars’ moon Phobos could be as much as 30 percent empty space, new observations suggest.” Sid Perkins, “Martian Moon Is Probably Porous,” *Science News*, Vol. 177, 5 June 2010, p. 11.
 69. “The surface of Phobos shows some spectral similarities to those of various asteroid types.” T. P. Andert et al., “Precise Mass Determination and the Nature of Phobos,” *Geophysical Research Letters*, Vol. 37, 7 May 2010, p. L09202–3.
 70. “It’s also unlikely Phobos is made solely of Mars’ crust blasted into space by an impact and then reassembled, because the spectral features of the moon’s rocks don’t match those of the Red Planet.” Perkins, p. 11.
 71. “Although none of the present models is fully satisfactory, neutral gas emission through water loss by Deimos at a rate of about 10²³ molecules per second, combined with a charged dust coma, is favored.” K. Sauer et al., “Deimos: An Obstacle to the Solar Wind,” *Science*, Vol. 269, 25 August 1995, p. 1075.
 - ◆ “Such events were detected, for example, at the crossing points of the spacecraft with the orbit of the martian moon Phobos.” Ibid.
 72. An orbit is a perfect circle if its eccentricity is 0.000. Earth’s orbital eccentricity about the Sun is 0.017 and Earth’s moon has an orbital eccentricity of 0.054. Having a moon’s orbit lie in its planet’s equatorial plane (which Earth’s moon does not) also demands a physical explanation for how that happened. Table 21 contains a listing of 40 moons whose orbits lie within two degrees of its planets equatorial plane and are remarkably circular. Therefore, those moons are probably asteroids captured shortly after the flood. [*The Astronomical Almanac for the Year 2012* (Washington, D.C.: U.S. Government Printing Office, 2011), pp. F2, F4.]
 73. For a given atmospheric mass, the lower its density, but thicker it is, the more its energy and momentum a potential moon will lose as it enters that atmosphere. Gas molecules within 360 Mars’ radii of Mars are more gravitationally attracted to Mars than the Sun. During the flood, an ocean of gas molecules were distributed throughout the inner solar system, so Mars’ atmosphere, as a first approximation, was about 360 Mars’ radii thick. Phobos currently orbits 2.77 Mars’ radii from Mars’ center of mass, well inside what was once a thick atmosphere.
 74. David Jewitt, “The Active Asteroids,” *The Astronomical Journal*, Vol. 143, March 2012, p. 66–79.
 75. “Could the MBCs [Main Belt Comets; comets in the asteroid belt] be comets from the Kuiper Belt or Oort Cloud that have become trapped in asteroid-like orbits? Published dynamical simulations suggest not, having failed to reproduce the transfer of comets to main-belt orbits.” Henry H. Hsieh and David C. Jewitt, “A Population of Comets in the Main Asteroid Belt,” *Science*, Vol. 312, 28 April 2006, p. 562.
 76. “[Based on the numbers of larger asteroids] ... current theories can’t adequately explain why so many of these small bodies should follow such circular routes.” D. L. Rabinowitz, as quoted by Ron Cowen, “Rocky Relics,” *Science News*, Vol. 145, 5 February 1994, p. 88.
 77. “... there is an excess of Earth-approaching asteroids with diameters less than 50 m, relative to the population inferred

- from the distribution of larger objects.” D. L. Rabinowitz et al., “Evidence for a Near-Earth Asteroid Belt,” *Nature*, Vol. 363, 24 June 1993, p. 704.
78. “Separately, over two-thirds of comet nuclei that have been imaged at high resolution show bilobate shapes, including the nucleus of comet 67P/Churyumov-Gerasimenko (67P), visited by the Rosetta spacecraft. Analysis of the Rosetta observations suggest that 67P’s components were brought together at low speed after their separate formation.” Masatoshi Hirabayashi, et al. “Fission and Reconfiguration of Bilobate Comets as Revealed by 67P/Churyumov-Gerasimenko,” *Nature*, Vol. 534, 16 June 2016, p. 352.
 79. S. C. Lowry et al., “The Internal Structure of Asteroid (25143) Itokawa as Revealed by Detection of YORP Spin-Up,” *Astronomy and Astrophysics*, Vol. 562, 5 February 2014, pp. 1–9.
 80. Craig Covault, “Historic Japanese Asteroid Data Amaze Researchers,” *Aviation Week & Space Technology*, 20 March 2006, p. 28.
 81. “Therefore comet 67P/Churyumov-Gerasimenko is an accreted body of two distinct objects with ‘onion-like’ stratifications, which formed before they merged. ... the strata of the two lobes are clearly independent of each other.” Matteo Massironi et al., “Two Independent and Primitive Envelopes of the Bilobate Nucleus of Comet 67P,” *Nature*, Vol. 526, 15 October, p. 402.
 - ◆ “Since the Rosetta spacecraft’s arrival last August [2014], researchers have debated whether 67P is a comet that lost some weight around its waistline or two comets that got a little too attached to one another. Layers and terraces on cliffs gave away 67P’s coupling. Mismatched layers between the comet’s head and body imply that the two lobes formed independently and later fused together. ... The strata in the head are slightly askew to those in the body.” Christopher Crockett, “Rocky Layers Reveal Recipe for Comet 67P,” *Science News*, Vol. 188, 31 October 2015, p. 17.
 82. Alexander N. Krot, “Bringing Part of an Asteroid Back Home,” *Science*, Vol. 333, 26 August 2011, pp. 1098–1099.
 - ◆ Tomoki Nakamura et al., “Itokawa Dust Particles: A Direct Link Between S-Type Asteroids and Ordinary Chondrites,” *Science*, Vol. 333, 26 August 2011, pp. 1113–1116.
 83. “We find that these asteroids can also undergo solar collisions, through several dynamical routes involving orbital resonances with the giant planets, on timescales of the order of 10^6 years.” Paolo Farinella et al., “Asteroids Falling into the Sun,” *Nature*, Vol. 371, 22 September 1994, p. 315.
 84. David C. Jewitt, “NASA’s Hubble Sees Asteroid Sprout Six Comet-Like Tails,” NASA News Release, 7 November 2013.
 85. David C. Jewitt et al., “The Extraordinary Multi-Tailed Main-Belt Comet P/2013 P5,” *The Astrophysical Journal Letters*, Vol. 778, 7 November 2013, pp. 2, 5.

Jewitt acknowledged that this object’s orbital parameters clearly show that it is an asteroid.
 86. Tony Phillips, “Corkscrew Asteroid,” http://science.nasa.gov/headlines/y2006/09jun_moonlets.htm.
 87. Paul A. Wiegert et al., “An Asteroidal Companion to the Earth,” *Nature*, Vol. 387, 12 June 1997, pp. 685–686.
 88. Steven J. Ostro et al., “Radar Detection of Asteroid 2002 AA29,” *Icarus*, Vol. 166, 2003, pp. 271–275. Ron Cowen, “Hidden Companion,” *Science News*, Vol. 152, 12 July 1997, p. 29.
 89. “Curiously, there are many more [asteroids] in the leading Lagrange point (L4) than in the trailing one (L5).” Bill Arnett, “Asteroids,” www.seds.org/nineplanets/nineplanets/asteroids.html
 - ◆ Data provided by the Harvard-Smithsonian Center for Astrophysics on 17 February 2005. See <http://cfa-www.harvard.edu/iau/lists/JupiterTrojans.html>.
 90. Paul Voosen, “NASA Missions Aim at Asteroid Oddballs,” *Science*, Vol. 355, 13 January 2017, p. 117.
 91. Franck Marchis et al., “A Low Density of 0.8 g cm^{-3} for the Trojan Binary Asteroid 617 Patroclus,” *Nature*, Vol. 439, 2 February 2006, pp. 565–567.
 - ◆ Ker Than, “Asteroids Near Jupiter Are Really Comets,” *Science & Space*, 1 February 2006, www.cnn.com/2006/TECH/space/02/01/jupiter.comets/index.html.
 92. “The particularly long lifetime of 2015BZ₅₀₉ on its retrograde orbit, in the same region of space as the largest planet in the Solar System, makes it arguably the most intriguing small body in this region. Further studies are needed to confirm how this mysterious object arrived at its present configuration.” Helena Morais and Fathi Namouni, “Reckless Orbiting in the Solar System,” *Nature*, Vol. 543, 30 March 2017, p. 636.
 93. Michael E. Zolensky et al., “Asteroidal Water within Fluid Inclusion-Bearing Halite in an H5 Chondrite, Monahans (1998),” *Science*, Vol. 285, 27 August 1999, pp. 1377–1379.
 94. “... crystals of sylvite (KCl) are present within the [meteorite’s] halite crystals, similar to their occurrence in terrestrial evaporites [salt deposits on Earth].” *Ibid.*, p. 1378.
 95. George Cooper et al., “Carbonaceous Meteorites As a Source of Sugar-Related Organic Compounds for the Early Earth,” *Nature*, Vol. 414, 20/27 December 2001, pp. 879–883.

The sugars in these meteorites (Murchison and Murray) were rich in heavy hydrogen, another indicator that they came from the subterranean chambers. [See page 318.]
 96. James Whitby et al., “Extinct ^{129}I in Halite from a Primitive Meteorite,” *Science*, Vol. 288, 9 June 2000, p. 1821.
 - ◆ Ulrich Ott, “Salty Old Rocks,” *Science*, Vol. 288, 9 June 2000, pp. 1761–1762.
 - ◆ “An H3–6 chondrite called Zag fell in the Moroccan Sahara desert five months [after the Monahans meteorite] that also had halite crystals with water inclusions.” Norton, p. 91.
 - ◆ John L. Berkley et al., “Fluorescent Accessory Phases in the Carbonaceous Matrix of Ureilites,” *Geophysical Research Letters*, Vol. 5, December 1978, pp. 1075–1078.

- ◆ D. J. Barber, “Matrix Phyllosilicates and Associated Minerals in C2M Carbonaceous Chondrites,” *Geochimica et Cosmochimica Acta*, Vol. 45, June 1981, pp. 945–970.
 - 97. Fred Hoyle and Chandra Wickramasinghe, *Lifecloud* (New York: Harper & Row, Publishers, 1978), p. 112.
 - 98. Magnus Endress et al., “Early Aqueous Activity on Primitive Meteorite Parent Bodies,” *Nature*, Vol. 379, 22 February 1996, pp. 701–703.
 - 99. “*The exact mechanism of terrestrial amino acid incorporation and retention by meteorites is not known.*” Jeffrey L. Bada et al., “A Search for Endogenous Amino Acids in Martian Meteorite ALH84001,” *Science*, Vol. 279, 16 January 1998, p. 365.
 - ◆ A. J. T. Jull et al., “Isotopic Evidence for a Terrestrial Source of Organic Compounds Found in Martian Meteorites Allan Hills 84001 and Elephant Moraine 79001,” *Science*, Vol. 279, 16 January 1998, pp. 366–369.
 - ◆ M. H. Engel and S. A. Macko, “Isotopic Evidence for Extraterrestrial Non-Racemic Amino Acids in the Murchison Meteorite,” *Nature*, Vol. 389, 18 September 1997, pp. 265–267.
 - ◆ Daniel P. Glavin et al., “The Effects of Parent Body Processes on Amino Acids in Carbonaceous Chondrites,” *Meteoritics & Planetary Sciences*, Vol. 45, 15 December 2011, pp. 1948–1972.
 - 100. Richard B. Hoover, “Fossils of Cyanobacteria in CI-1 Carbonaceous Meteorites,” *The Journal of Cosmology*, Vol. 13, March 2011, pp. 3811–3848.
 - 101. Michael Callahan, “NASA Researchers: DNA Building Blocks Can Be Made in Space,” NASA press release, 8 August 2011 at: www.nasa.gov/topics/solarsystem/features/dna-meteorites.html
Various tests on these meteorites ruled out contamination.
 - 102. Ian D. Hutcheon, “Signs of an Early Spring,” *Nature*, Vol. 379, 22 February 1996, pp. 676–677.
 - ◆ “*The salts we found mimic the salts in Earth’s ocean fairly closely.*” Carleton Moore as reported at www.cnn.com on 23 June 2000. For details, see Douglas J. Sawyer et al., “Water Soluble Ions in the Nakhla Martian Meteorite,” *Meteoritics & Planetary Science*, Vol. 35, July 2000, pp. 743–747.
 - ◆ “*... a variety of minerals in three nakhlite meteorites, including a fragment of the Nakhla meteorite collected within days of its fall, seem to have precipitated from a brine.*” Richard A. Kerr, “A Wetter, Younger Mars Emerging,” *Science*, Vol. 289, 4 August 2000, p. 715.
 - 103. E. Deloule et al., “Deuterium-Rich Water in Meteorites,” *Meteoritics*, Vol. 30, September 1995, p. 502.
 - ◆ Ron Cowen, “Martian Leaks: Hints of Present-Day Water,” *Science News*, Vol. 158, 1 July 2000, p. 15.
 - ◆ Laurie Leshin Watson et al., “Water on Mars: Clues from Deuterium/Hydrogen and Water Contents of Hydrous Phases in SNC Meteorites,” *Science*, Vol. 265, 1 July 1994, pp. 86–90.
- Although Cowen and Watson believe that these meteorites came from Mars, page 353 explains why this is unlikely.
- 104. “*Some different microbial species, derived from samples of [two] meteorites, have been cultured, cloned and classified by 16S rDNA typing and found to be not essentially different from present day organisms [here on Earth]; they also appear sensitive to growth inhibition by specific antibiotics.*” Giuseppe Geraci et al., “Microbes in Rocks and Meteorites,” *Rendiconti Accademia Nazionale dei Lincei*, Vol. 12, No. 9, 2001, p. 51.
- These DNA studies also rule out contamination, because the bacteria recovered and cultured from the meteorites were sufficiently different from modern strains.
- ◆ “*Bruno D’Argenio, a geologist working for the Italian National Research Council, and Giuseppi Geraci, professor of molecular biology at Naples University, identified and brought back to life extraterrestrial microorganisms lodged inside [a supposedly] 4.5 billion-year-old meteorite kept at Naples’ mineralogical museum.*” Rossella Lorenzi, “Scientists Claim to Revive Alien Bacteria,” *Discovery News*, www.discovery.com, 10 May 2001.
 - 105. “*The foregoing analysis, sketchy as it is, seems to strengthen the grounds of the old speculation—that meteorites are disrupted fragments of a planet of the terrestrial type.*” Reginald A. Daly, “Meteorites and an Earth-Model,” *Bulletin of the Geological Society of America*, Vol. 54, 1 March 1943, p. 425.
- Because meteorites are so similar to the material inside Earth, many researchers believe that the Earth formed from infalling meteoroids. One should also consider whether *the Earth produced meteoroids*. Failure to consider both possibilities is the same logical fallacy described in Endnote 4, page 325. Much evidence opposes the former.
- 106. Birger Schmitz et al., “Sediment-Dispersed Extraterrestrial Chromite Traces a Major Asteroid Disruption Event,” *Science*, Vol. 300, 9 May 2003, pp. 961–964.
 - 107. Jonathan Gradie and Joseph Veverka, “The Composition of the Trojan Asteroids,” *Nature*, Vol. 283, 28 February 1980, pp. 840–842.
 - 108. “*Recent spacecraft studies of Comet 67P/Churyumov-Gerasimenko with Rosetta and of [asteroid] Ceres ... provide evidence that complex organic molecules and even amino acids are ubiquitous on small bodies in the solar system and that water ice is abundant in the asteroid belt.*” Michael Kuppers, “Dwarf Planet Ceres and the Ingredients of Life,” *Science*, Vol. 355, 17 February 2017, p. 692.
 - 109. Asphaug, “The Small Planets,” p. 46.
 - 110. Joshua L. Bandfield et al., “Spectroscopic Identification of Carbonate Minerals in the Martian Dust,” *Science*, Vol. 301, 22 August 2003, pp. 1084–1087.
 - ◆ “*Two Phoenix [Mars Lander] experiments identified calcium carbonates and clays in soil samples scooped up by the crafts robotic arm. On Earth, both minerals are associated with the presence of liquid water.*” Ron Cowen, “More Clues to Martian Chemistry,” *Science News*, Vol. 174, 25 October 2008, p. 13.

111. “[A sample of dirt from an asteroid] *could finally explain why the most common type of asteroid looks different—spectroscopically more red—from the most common type of meteorite. Apparently, some sort of ‘space weathering’ is reddening the surface of S-type asteroids.*” Richard A. Kerr, “Beaming to Itokawa,” *Science*, Vol. 309, 16 September 2005, p. 1797.

Yes, most asteroids were “weathered” (rusted) by oxygen gas in the inner solar system soon after the flood. Since then, that gas has dispersed.

112. “*Unfortunately, Mars spent its youth in a bad neighborhood near the asteroid belt, and, being small, was especially susceptible [to asteroid impacts and the loss of its atmosphere]. Given the expected size distribution of impactors early in a solar system’s history, the planet should have been stripped of its entire atmosphere in less than 100 million years.*” David C. Catling and Kevin J. Zahnle, “The Planetary Air Leak,” *Scientific American*, Vol. 300, May 2009, p. 42.

“For decades, scientists have pondered why Mars has such a thin atmosphere, but now we wonder: Why does it have any atmosphere left at all?” Ibid., p. 36.

113. “*The D/H [deuterium-to-hydrogen] value [for water locked in Martian clays] is 3.0 (± 0.2) times the ratio in standard mean ocean water.*” P. R. Mahaffy et al., “The Imprint of Atmospheric Evolution in the D/H of Hesperian Clay Minerals on Mars,” *Science*, Vol. 347, 22 January 2015, p. 412.

114. Pure liquid water cannot exist for long at temperatures below 32°F or at pressures below 6 mbar (0.0888 psia). This pressure-temperature combination, called the *triple point*, allows water to exist simultaneously in three states: solid, liquid, and gas. Because the average surface temperature of Mars is colder than -80°F and the atmospheric pressure is 6–10 mbar, liquid water would quickly freeze on Mars.

Actually, the water on Mars is saltwater, which can remain liquid far below water’s so-called freezing point. One must ask, “Where did the liquid water come from that dissolved the salts?” Answer: the subterranean water chamber on the pre-flood Earth.

115. Michael C. Malin et al., “Present-Day Impact Cratering Rate and Contemporary Gully Activity on Mars,” *Science*, Vol. 314, 8 December 2006, pp. 1573–1577.

- ◆ S. W. Squyres et al., “Ancient Impact and Aqueous Processes at Endeavour Crater, Mars,” *Science*, Vol. 336, 4 May 2012, pp. 570–575.

116. “*The presence of brines [in these groundwater discharges] is the most realistic scenario for Mars, requiring modest quantities of water and no geothermal heat. Furthermore, the brine model exhibits a dependence of discharge on season and favors equator-facing slopes in the middle to high latitudes ...*” Alfred S. McEwen et al., “Seasonal Flows on Warm Martian Slopes,” *Science*, Vol. 333, 5 August 2011, p. 742.

117. “*The evidence disturbed the scientists in more than one respect. First, conditions on Mars are such that any water reaching the surface supposedly would not remain liquid for*

very long but would boil, freeze, or poof into vapor. Second, from the absence of craters, sand dunes, or anything else on top of the [eroded] gullies, they appeared to have formed very recently, possibly as recently as yesterday. ... Most of the evidence was found, strikingly, in some of the coldest places on the surface—on shadowed slopes facing the poles, in clusters scattered around latitudes higher than 30 degrees—rather than at the warmer equatorial latitudes. ... And proposals for other substances that might behave as liquids on the martian surface raised so many other questions that they failed to solve the problem.” Kathy Sawyer, “A Mars Never Dreamed Of,” *National Geographic*, Vol. 199, February 2001, p. 37.

118. “*The surface of Mars is so cold—on average -70° to -100°C [-94°F to -148°F]—that any water within 2 or 3 kilometers of the surface, never mind a meter or two, should be permanently frozen, they noted.*” Kerr, “Rethinking Water on Mars and the Origin of Life,” *Science*, Vol. 292, 6 April 2001, p. 39.

- ◆ Many Mars researchers cling to the belief that Mars once had oceans or considerable subsurface water. Why? If Mars once had liquid water, they argue, life might have evolved, because life (as we know it) requires liquid water. Notice their faulty logic.

Instead, if A (life) requires B (water), the presence of B does not demand the presence of A. (*Water is a necessary but not sufficient requirement for life.*) Ignored is life’s extreme complexity. [Pages 14 – 23 explain why life is so complex that it could not have evolved anywhere in trillions upon trillions of years.] When scientists hold out hope of discovering life on Mars, funding for their research is more likely. Also, an excited media will sensationalize and publicize that research, raising hopes that life may be found on Mars.

Most scientific researchers are in a perpetual hunt for money to fund their work and pay their salaries. If asteroids and comets placed water on Mars *recently*, few evolutionists would expect that life evolved on Mars. Therefore, a major reason for funding the exploration of Mars disappears.

119. “*Carving them, researchers calculated, would take water gushing at 10 million to 1 billion cubic meters per second.*” Richard A. Kerr, “An ‘Outrageous Hypothesis’ for Mars: Episodic Oceans,” *Science*, Vol. 259, 12 February 1993, p. 910.

120. See Endnote 41 on page 329.

121. “*Such streams typically originate in steep-walled amphitheaters rather than in ever smaller tributaries.*” Arden L. Albee, p. 50.

122. “*But the limited amount of erosion suggests that it wasn’t the result of a ‘warm and wet’ early Mars.*” Richard A. Kerr, “Running Water Eroded a Frigid Early Mars,” *Science*, Vol. 300, 6 June 2003, p. 1497.

123. “*Most of the tens of thousands of gullies identified to date occur on slopes in craters, pits, and other depressions at latitudes > 30°;*” Malin et al., p. 1575.

124. “*On the other hand, Edgett has noted a central peak of an impact crater replete with gullies. Where would the water come from to feed a seep high on a central peak, he wondered.*” Kerr, “Rethinking Water” p. 39.

A crater-producing impact often creates a peak in the center of the crater floor. Gravity from nearby terrain applies upward pressure under the new crater floor, causing it to suddenly buckle upward at its weakest point—its center—creating a peak. This is similar to the mechanism that formed the Mid-Oceanic Ridges.

125. Shane Byrne et al., “Distribution of Mid-Latitude Ground Ice on Mars from New Impact Craters,” *Science*, Vol. 325, 25 September 2009, pp. 1674–1676.
126. “... near the poles, Mars Odyssey [spacecraft] has shown, as much as 50 percent of the upper meter of soil may be [water] ice.” Arden L. Albee, “The Unearthly Landscapes of Mars,” *Scientific American*, Vol. 288, June 2003, p. 46.
127. On 9 July 2000, after the 30 June 2000 (Volume 288) issue appeared containing pictures of erosion channels on Mars, I wrote the following letter to *Science* magazine. My letter was titled “Comets Carved the Mars’ Gullies.”

Dear Editor:

Why aren’t comets considered as the source of the water that carved Mars’ erosion features? Impact energy would convert a comet’s ice to liquid water. A typical comet, perhaps 10^{16} grams and 85% H_2O , could easily provide the volume of water estimated in Endnote 35 on page 2335.

Assume that large rocks are in the center of comets (a point I will not try to justify here). Those rocks, decelerating less than the surrounding ice as the comet passes through Mars’ thin atmosphere, strike the ground an instant earlier than the ice and create the crater. The ice, suddenly converted to liquid and splattered onto the crater walls, carves the gullies.

The typical ground temperatures of -70°C (or colder) in the gully regions is fatal to claims that large volumes of liquid water suddenly “seeped” from several hundred meters below Mars’ surface. Straining to overcome this fact by imagining saline solutions, unusually high heat flow on Mars, exotic liquids, lower than expected thermal conductivities, and Mars tipped on its axis is speculation on top of speculation. Why not consider the simple possibilities first?

If the water could not come from below, maybe it came from above.

Science magazine did not print this letter.

Today (2008), after the Deep Impact space mission to comet Tempel 1, the best estimate for the amount of water on a comet is 38% by mass.

128. Richard A. Kerr, “Signs of Ancient Rain May Stretch Mars’ Balmy Past,” *Science*, Vol. 305, 2 July 2004, p. 26.
- ◆ “... episodes of scalding rains followed by flash floods.” Teresa L. Segura et al., “Environmental Effects of Large Impacts on Mars,” *Science*, Vol. 298, 6 December 2002, p. 1979.
 - ◆ “... great craters appear to have been filled to overflowing by rain on early Mars.” Richard A. Kerr, “A Smashing Source

of Early Martian Water,” *Science*, Vol. 298, 6 December 2002, p. 1866.

129. Richard A. Kerr, “Minerals Cooked Up in the Laboratory Call Ancient Microfossils into Question,” *Science*, Vol. 302, 14 November 2003, p. 1134.
130. R. O. Pepin, “Evidence of Martian Origins,” *Nature*, Vol. 317, 10 October 1985, pp. 473–475.
131. “... martian meteorites are not representative of the planet’s crust.” Stella Hurtley, “Mars Matters,” *Science*, Vol. 324, 8 May 2009, p. 687.
- ◆ “It has become apparent that Martian meteorites have different chemical compositions from rocks analysed on the planet’s surface.” Harry V. McSween, “A Chunk of Ancient Mars,” *Nature*, Vol. 503, 28 November 2013, p. 475.
 - ◆ Richard L. S. Taylor and David W. Mittlefehldt, “Missing Martian Meteorites,” *Science*, Vol. 290, 13 October 2000, pp. 273–275.
132. “... parts of ALH84001 show signs of having melted and reformed ...” Lisa Grossman, “Martian Meteorite’s Age Reduced,” *Science News*, Vol. 177, 8 May 2010, p. 10.
- ◆ Indeed, “one Mars meteorite, Nakhla, shows evidence it was immersed in an ancient brine.” Peter H. Smith, “Digging Mars,” *Scientific American*, Vol. 305, November 2011, p. 55.
- What is the more likely source of the glass nodules, melted rocks, and brine? Supercold Mars or in the superhot subterranean chamber?
133. “... we estimate that the probability of finding on Earth a fragment ejected from Mars is about 10^{-6} to 10^{-7} .” James N. Head et al., “Martian Meteorite Launch: High-Speed Ejecta from Small Craters,” *Science*, Vol. 298, 29 November 2002, p. 1753.
134. “... there remains the question of whether we should not be up to our necks in lunar meteorites—that is, what would be the expected relative fluxes of objects from the Moon and Mars and why have we seen so few from the Moon?” Pepin, p. 474.
135. Joseph L. Kirschvink et al., “Paleomagnetic Evidence of a Low-Temperature Origin of Carbonate in the Martian Meteorite ALH84001,” *Science*, Vol. 275, 14 March 1997, p. 1629.
136. “About 20% of the ejecta are rock vapors; most of the rest is melt.” Segura et al., p. 1977.
137. Christopher D. K. Herd et al., “Origin and Evolution of Prebiotic Organic Matter as Inferred from the Tagish Lake Meteorite,” *Science*, Vol. 332, 10 June 2011, p. 1304.
138. “The complex suite of organic materials in carbonaceous chondrite meteorites probably originally formed in the interstellar medium and/or the solar protoplanetary disk, but were subsequently modified in the meteorites’ asteroidal parent bodies. The mechanisms of formation and modification are still very poorly understood.” *Ibid.*, p. 1304.
139. *Ibid.*
140. *Ibid.*, p. 1305.
- ◆ “The conditions of hydrothermal alteration inferred by analogy with experiments, especially temperature, are at

- odds with the [observed] mineralogy and preservation of volatile organic compounds.*" Ibid., p. 1307.
141. "Amino acid concentrations and enantiomeric excesses in the Tagish Lake specimens provide further evidence of the influence of parent body aqueous alterations on SOM [soluble organic matter]." Ibid., p. 1306. [Note: enantiomers are mirror images of each other.]
 142. "Sub-micrometer scale carbonaceous globules that are often substantially enriched in ^{15}N and D [hydrogen-2] and are thought to have formed in the interstellar medium" Herd et al., p. 1304.
 143. Alfred S. McEwen, "Mars in Motion," *Scientific American*, Vol. 308, May 2013, p. 60.
 144. Alfred S. McEwen, as quoted by Corey S. Powell, "Weirdlands of Mars," *Discover*, June 2014, p. 60.
 - ◆ "Among other things, Mars researchers have found it increasingly hard to explain how the planet might have stayed warm and wet in its early history." Alexandra Witze, "Mars Slow to Yield Its Secrets," *Science*, Vol. 511, 24 July 2014, p. 396.
 145. Daniel Clery, "Lake Spied Deep Below Polar Ice Cap on Mars," *Science*, Vol. 361, 27 July 2018, p. 320.
 - ◆ R. Oroseli, et al., "Radar Evidence of Subglacial Liquid Water on Mars," *Science*, Vol. 361, 3 August 2018, pp. 490–493.
 - ◆ Anja Diez, "Liquid Water on Mars," *Science*, Vol. 361, 3 August 2018, pp. 448–449.
 - ◆ Alexandra Witze, "Signs of buried Lake on Mars Tantalize Scientists," *Nature*, Vol. 650, 2 August 2018, pp. 13–14.
 146. "... if summer temperatures are warm enough to melt briny ice, then the ice should disappear over time." McEwen, *Scientific American*, Vol. 308, May 2013, p. 65.

Yes, frozen ice below Mars' surface is disappearing. But since so much saltwater was deposited so recently (soon after Earth's global flood about 5,000 years ago), some still remains.
 147. "Water ice should not be stable equatorward of $\pm 30^\circ$." Jack T. Wilson et. al, "Equatorial Locations of Water on Mars," *Icarus*, Vol. 299, August 2018, p. 148.
 148. Lorenzo Iorio, "Dynamical Determination of the Mass of the Kuiper Belt from Motions of the Inner Planets of the Solar System," *Monthly Notices of the Royal Astronomical Society*, Vol. 375, 11 March 2007, p. 1311.
 149. This estimate of the total mass of TNOs is based on two studies that used completely different techniques, each with their strengths and limitations. The first, referenced in Endnote 148 above, arrived at 0.04 Earth masses; the second concluded that the TNO region contained 0.02 Earth masses. [See Cesar I. Fuentes and Matthew J. Holman, "A Subaru Archival Search for Faint Trans-Neptunian Objects," *The Astronomical Journal*, Vol. 136, July 2008, pp. 83–97.]
 150. "[Phoebe] presumably originated from the same primordial population shared by the dynamically excited Kuiper Belt Objects [KBOs which] received high-resolution spectral imaging during the Cassini flyby. The range of Phoebe's water -ice absorption spans the same range exhibited by dynamically excited KBOs." Wesley C. Fraser and Michael E. Brown, "Phoebe: A Surface Dominated by Water," *The Astronomical Journal*, Vol. 156, July 2018, p. 23.
 151. "Quaoar, a large body in the Kuiper Belt, has crystalline water ice on its surface, yet conditions there should favour amorphous ice." David J. Stevenson, "Volcanoes on Quaoar?" *Nature*, Vol. 432 9 September 2004, p. 681.

No volcanoes have ever been reported on a TNO.

 - ◆ "We calculate the rate at which crystalline water ice is amorphized by solar UV/visible radiation [on Charon], finding that at the depths probed by H and K observations (0.35 mm), the e-folding time to amorphize ice is $(3-5) \times 10^4$ yr." Jason C. Cook and Steven J. Desch, "Near-Infrared Spectroscopy of Charon: Possible Evidence for Cryovolcanism on Kuiper Belt Objects." *The Astrophysical Journal*, Vol. 663, 10 July 2007, p. 1406.

The authors favor some heating mechanism inside Charon to warm water enough for it to erupt and produce crystalline ice. But unlike the heat produced inside Saturn's Enceladus or Jupiter's Io, there is no giant planet near enough to produce the tidal stresses necessary. Instead, the heating mechanism was probably the collapse of Charon's swarm.
 152. "... crystalline water ice [on Quaoar] should be destroyed by energetic particle irradiation on a time scale of about 10^7 yr." David C. Jewitt and Jane Luu, "Crystalline Water Ice on the Kuiper Belt Object (50000) Quaoar," *Nature*, Vol. 432 9 September 2004, p. 731.
 153. Ron Cowen, "Outer Limits," *Science News*, Vol. 169, 14 January 2006, p. 27.] [Also see Endnote 1 on page 364.]
 - ◆ Vol. 222, 2013, p. 1.
 154. "But planetary scientists do not have a plausible explanation for how a moon might have appeared there to begin with, [Marc] Buie says." Alexandra Witze, "Pluto Mission Hunts for Hazards," *Nature*, Vol. 521, 7 May 2015, p. 15.
 155. "Based on our sample and the literature, up to ~50% of the small Plutinos are potential contact binaries." Audrey Thiroulin, "The Plutino Population: An Abundance of Contact Binaries," <https://arxiv.org/pdf/1804.09695.pdf>, p. 1.
 156. Amanda A. Sickafoose, "Ring Detected around a Dwarf Planet," *Nature*, Vol. 550, 12 October 2017, pp. 197–198.
 - ◆ J. L. Ortiz, et al., "The Size, Shape, Density and Ring of the Dwarf Planet Haumea from a Settler Occultation," *Nature*, Vol. 550, 12 October 2017, pp. 219–223.
 157. "Saturn's are the most studied of all rings, and yet they remain enigmatic. ... the formation mechanisms responsible for other rings remain uncertain."
 158. F. Braga-Ribas et al., "Tiny Chariklo Has Rings of Its Own," *Nature*, Vol. 507, 27 March 2014, p. 433.
 159. "But a dirty secret of planetary rings should be exposed: following exhaustive searches since 2004 using the Cassini spacecraft, it is almost certain that none of the numerous gaps in Saturn's C ring and in its Cassini Division (low density band between Saturn's main A and B rings) harbour

any shepherds of the requisite size.” Joseph A. Burns, “Ring in the New,” *Nature*, Vol. 508, 3 April 2014, p. 49.

Why is this significant? Without the gravity of nearby bodies (called *shepherds*) to hold rings in place, they rapidly dissipate.

Moreover, an unperturbed ring several kilometers in width and of thickness h [meters] should spread, owing to interparticle collisions, in $10^4/h$ years or a few thousand years, assuming [an] h of a few metres ... Thus the rings are either very young or actively confined [by a shepherd]. [See F. Braga-Ribas et al., “A Ring System Detected around the Centaur (10199) Chariklo,” *Nature*, Vol. 508, 3 April 2014, p. 74.]

Chariklo’s two rings are about 7 and 3 kilometers wide. The gap between them could be explained if Chariklo had shepherding moons, but so far, none have been found. (Even if they could be found, would they be massive enough to perform their shepherding duties?) Saturn “almost certainly” does not have shepherds that can account for its gaps. Therefore, Saturn’s rings are “almost certainly” a few thousand years young, and Chariklo’s gap, so far, appears equally young.

160. J. Horner et al., “Simulations of the Population of Centaurs I: The Bulk Statistics,” *Monthly Notices of the Royal Astronomical Society*, Vol. 354, 2 February 2008, pp. 798–810.
161. F. Braga-Ribas et al., “Tiny Chariklo Has Rings of Its Own,” *Nature*, Vol. 507, 27 March 2014, p. 433.
162. David C. Jewitt, as quoted by Christopher Crockett, “Icy Rings Found Around Tiny Space Rock,” *Science News*, Vol. 185, 3 May 2014, p. 10.
163. “Starting in April [2017], the spacecraft began threading the gap between Saturn and its rings once a week, and approach thought to be too dangerous earlier in the mission. At first, Cassini wielded its large radio antenna as a shield to protect itself from stray ring particles. The precaution was unnecessary; the gap was almost empty.” Paul Voosen, “A Fiery Finish to Cassini’s Long Run at Saturn,” *Science*, Vol. 357, 22 September 2017, pp. 1219–1220.
164. “We find that the colors of [TNOs with low angles of inclination are] *primarily red ...*” Amanda A. S. Gulbis et al., “The Color of the Kuiper Belt Core,” *Icarus*, Vol. 183, 1 July 2006, p. 168.

Why would TNOs *with low angles of inclination* be red? Much of the water launched by the fountains of the great deep would have vaporized and slowly formed a thin disk of water vapor aligned with the ecliptic and eventually extending beyond Neptune. Therefore, iron in the surface rocks of TNOs with low orbital inclinations (those not perturbed into the scattered disk as they spiraled outward) would experience considerable oxidation (rusting).

165. “Giant icy mountains in Pluto’s southern hemisphere tower more than 3,500 meters [actually 15,000 feet or 2.8 miles] high in the first high-resolution images that New Horizons sent back. The peaks’ sheer height signals that they are made of water ice, the only material that could buttress such huge ridges at Pluto’s frigid temperatures of less than -223°C , just 50°C , above absolute zero.” Alexandra Witze, “Vibrant Pluto Seen in Historic Fly-By,” *Nature*, Vol. 523, 23 July 2015, p. 389.

166. Dwayne Brown and Laurie Cantillo, New Horizons, <http://pluto.jhuapl.edu/News-Center/News-Article.php?page=20150715>
- ◆ “Pluto’s diverse surface geology and long-term activity also raise fundamental questions about how it has remained active many billions of years after its formation.” S. Alan Stern et al., “The Pluto System: Initial Results from its Exploration by New Horizons,” *Science*, Vol. 350, 16 October 2015, p. 292.
167. Scott J. Kenyon, “Pluto Leads the Way in Planet Formation,” *Nature*, Vol. 522, 4 June 2015, p. 40.
168. Mark Showalter as quoted by Christopher Crockett, “Pluto’s Smaller Moons Pose Mysteries,” *Science News*, Vol. 188, 28 November 2015, p. 14.
169. “This observation is surprising, as it is difficult to imagine how to bind two small bodies that never come closer to each other than a distance of 85,000 km [53,000 miles].” Jean-Marc Pettit et al., “The Extreme Kuiper Belt Binary 2001 QW₃₂₂,” *Science*, Vol. 322, 17 October 2008, p. 433.
170. “Jean-Luc Margot, “Worlds of Mutual Motion,” *Nature*, Vol. 416, 18 April 2002, pp. 694–695.
171. Ultima Thule (UT) also has the technical name, MU₆₉.
172. John Travis, “A Double Target for a Distant Probe?” *Science*, Vol. 357, 11 August 2017, p. 532.
173. “But particles can’t stick unless they collide gently. Careening rocks and ice chunks in elongated, high-inclination orbits—like many of those in the Kuiper Belt today—would hit with high velocity, which would break them [the flying rock piles] apart instead of building them up. Only objects in more circular orbits have low enough relative velocities to coalesce. That means that the belt’s biggest bodies ... would never have formed unless they originally followed more circular, low-inclination orbits. In addition, the belt must have been much more crowded and thousands of times heavier than it is today. Like a ghostly highway with only a few cars, the belt nowadays has such a low density of objects that any collision—whether a high-speed crack-up or a low speed merger—is improbable.” Ron Cowen, “On the Fringe,” *Science News*, Vol. 177, 16 January 2010, p. 17.
174. Michael C. Lemonick, “Pluto and Beyond,” *Scientific American*, Vol. 311, November 2014, p. 52.
175. Before moons were discovered around asteroids, asteroid mass could be estimated only by multiplying an asteroid’s volume by its assumed density. Such assumptions produced considerable error, because from Earth each asteroid looked like a big, solid rock, not a flying rock pile containing ice and voids. Now that moons can be observed orbiting many asteroids, their masses and extremely low densities can be calculated directly. Using their average density, the total mass of all asteroids in the inner solar system can be more accurately estimated. While not all asteroids have been identified, the volumes of the largest thousand or so have been measured. Statistically, their size distribution shows that the smallest asteroids, although numerous, contribute relatively little to the total mass of all asteroids.

The Cassini mission to Saturn flew near Saturn’s irregular moon, Hyperion, a captured asteroid, as explained earlier.

(Its density is 0.544 gm/cm³, light enough to float high in water if it were placed in a very large bathtub.) Hyperion also contains organic matter. What do you suppose was its origin? A good guess would be that the organic matter came from Earth—the only place where we know life exists. [See P. C. Thomas et al., “Hyperion’s Sponge-Like Appearance,” *Nature*, Vol. 448, 5 July 2007, pp. 50–53.]

The low densities of comets, asteroids, and TNOs are not surprising when one understands how they formed. Consider that:

❖ “[Comet Tempel 1 is] *the size of a mountain held together with the strength of the meringue in a lemon meringue pie.*” Carey M. Lisse, as quoted by Ron Cowen, “Deep Impact,” *Science News*, Vol. 168, 10 September 2005, p. 169.

❖ “[The comet’s] *structure is more fragile than that of a soufflé ...*” Jay Melosh, as quoted by Ron Cowen, *Ibid.*, p. 168.

176. Chadwick A. Trujillo and Scott S. Sheppard, “A Sedna-Like Body with a Perihelion of 80 Astronomical Units,” *Nature*, Vol. 507, 27 March 2014, pp. 471–473.

177. Megan E. Schwamb, “Stranded in No-Man’s-Land,” *Nature*, Vol. 507, 27 March 2014, p. 436.

178. R. B. Brown, personal communication on 21 May 2014.

179. A confidence level of 99.99% means that the statistical result could have been due to chance, but only 1 out of 10,000 times.

180. “*You would expect the arguments of perihelion to have been randomized over the life of the solar system.*” Scott Sheppard as quoted by Michael D. Lemonick, “The Search for Planet X,” *Scientific American*, Vol. 314, February 2016, p. 32.

◆ Two perturbing forces that caused this were:

i. thrusting described on page 356.

ii. gravitational forces of the Sun and planets acting on each TNO. (Because all orbiting bodies were not coplanar, these perturbation forces were not zero.)

For a good discussion of how perturbing forces change ϖ over time, see Roger Bate et al., *Fundamentals of Astrodynamics* (New York: Dover Publishing, Inc., 1971), pp. 396–407. Notice on page 405 that the rate of change of ϖ is extremely rapid when eccentricity is near zero, which is the case for objects spiraling outward from the Sun.

181. Christopher Crockett, “Shadow Planet,” *Science News*, Vol. 186, 29 November 2014, p. 19.

182. Carnot engines are the simplest of all thermodynamic engines. To understand Carnot engines, consult any introductory textbook on thermodynamics.

183. Andrew J. Dombard and Sean O’Hara, “Pluto’s Polygons Explained,” *Nature*, Vol. 534, 2 June 2016, p. 40.

184. “*But neither [study] satisfactorily addresses how so much of the nitrogen budget could have collected there [on Pluto]. ... Clearly, this localization of nitrogen was a major event in Pluto’s evolution that needs to be explored.*” *Ibid.*, p. 41.

185. “*Internal heat could send molten blobs of material to the surface, driving geysers or even watery volcanoes that could spew fresh ices onto the surface. That scenario gained support when an early close-up picture revealed mountains, some 3500*

meters high, composed of water ice. At Pluto’s temperatures, water ice is the bedrock: too solid to flow or sublime. So the presence of ice mountains implies that deep forces pushed them up. At the same time, surrounding plains of ice were remarkably crater-free—suggesting that another process had paved them over.” Eric Hand, “Scientists Ponder an Improbably Active Pluto,” *Science*, Vol. 349, 24 July 2015, p. 353.

186. John Travis, “Ice Volcanoes on Pluto’s Surface,” *Science*, Vol. 350, 13 November 2015, p. 722.

187. A. J. Trowbridge et al., “Vigorous Convection as the Explanation for Pluto’s Polygonal Terrain,” *Science*, Vol. 534, 2 June 2016, p. 79.

188. Renu Malhotra, “Migrating Planets,” *Scientific American*, Vol. 281, September 1999, p. 59.

189. Mike Brown, as quoted by Ron Cowen, “Outer Limits,” pp. 26, 28.]

190. “*But Sedna and other objects beyond the main Kuiper Belt probably weren’t born where they are today, because there simply wasn’t enough gas and dust available at those great distances to create sizeable worlds.*” Alexandra Witze, “On the Hunt for a Mystery Planet,” *Nature*, Vol. 531, 17 March 2016, p. 291.

191. Scott S. Sheppard as quoted by Christopher Crockett, “Shadow Planet,” *Science News*, Vol. 186, 29 November 2014, p. 18.

192. The efficiency of a Carnot engine is the temperature difference between the hot and cold sides divided by the hot side’s absolute temperature. At 1 AU, Pluto’s swarm would have had a temperature difference of about 510°F, similar to Earth’s moon. [See [Figure 182 on page 339](#).] The average difference between Earth’s day and night temperatures is about 25°F. Therefore the ratio in efficiencies is about 15).

193. Alexandra Witze, “Flying on Sunshine,” *Science News*, Vol. 18, 10 September 2011, p. 19.

194. Gravity boosts *by a giant planet* can easily place a TNO in a highly inclined orbit. Xena and Buffy are two such TNOs. Their high angles of inclination have perplexed evolutionists.

Xena and Buffy stick out like sore thumbs. No theory, even one in which planets plow through the Kuiper Belt, can explain such high tilts, notes [Harold F.] Levison. He and other theorists are struggling to incorporate these new finds into their models. [See Cowen, “Outer Limits,” p. 28.]

Levison has it backwards. Rather than imagining a planet “plowing through the Kuiper Belt,” he should consider outward spiraling TNOs passing near any giant planet.

195. Sushil K. Atreya, “The Mystery of Methane on Mars & Titan: It might mean Life”; *Scientific American*, Vol. 296, May 2007, p. 42.

196. Schwamb, p. 435.

197. Konstantin Batygin and Michael E. Brown, “Evidence for a Distant Giant Planet in the Solar System,” *The Astronomical Journal*, Vol. 151, 20 January 2016, pp. 22–35.

◆ Eric Hand, “Number 9,” *Science*, Vol. 351, 22 January 2016, pp. 330–333.

198. Cowen, “On the Fring,” p. 17.]

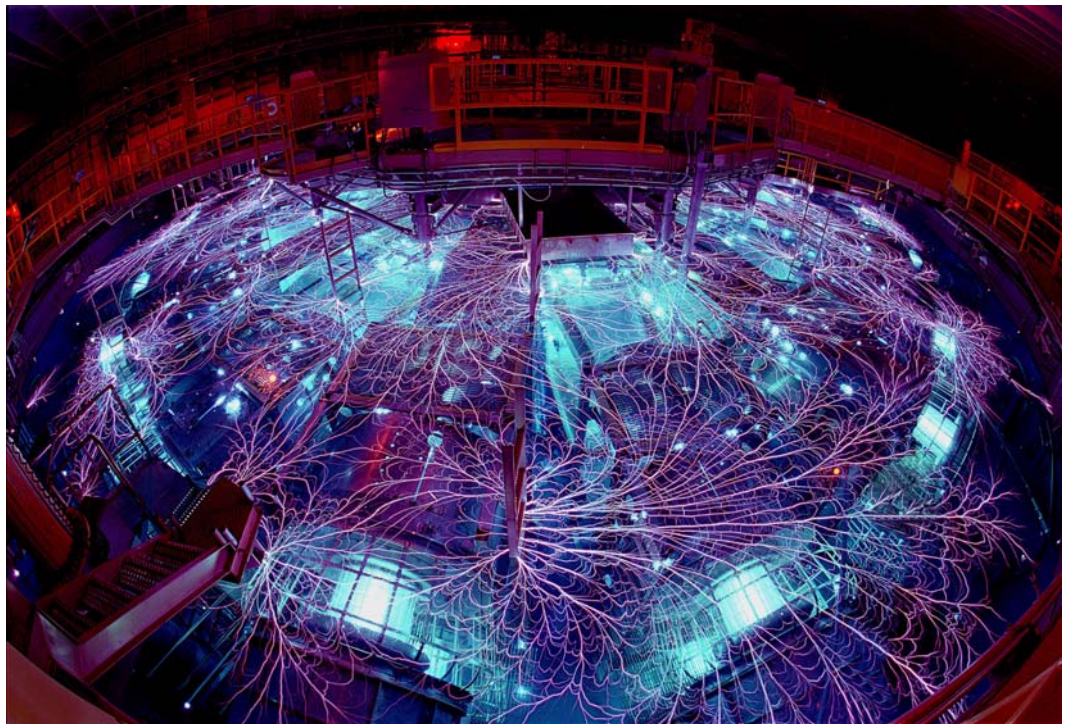

Figure 201: What Is a Plasma? Unlike the familiar states of matter—solids, liquids, and gases—a plasma is a state of matter that is so hot that atomic nuclei cannot hold onto their electrons. At least 99% of the matter in the visible universe is plasma. Plasma is like a hot gas, but contains a vast but nearly equal number of free positive and negative electrical charges. It is the material of stars and thinly permeates our solar system, our galaxy, and the universe. Examples of plasma on Earth include the glowing material inside a neon sign, a welder's arc, and a lightning bolt. Fortunately, Earth has little plasma.

During a thunderstorm, clouds build up electrical charges which differ from those in the solid Earth below. If that electrical difference (or *voltage*) becomes large enough, air along one or more paths *breaks down* into flowing electrons and positive charges—atoms and molecules that have lost electrons. They collide with and heat other air molecules, stripping away more electrons and leaving behind an extremely thin trail of flowing electrical charges. Near each branch of the lightning bolt, intensely heated air expands so fast that it makes a loud crack, whose rumbling echoes are thunder.

Electrical breakdown can also occur in solids and liquids. Breakdown begins when a powerful voltage removes an electron from a neutral atom, giving the atom a positive charge. These positive charges and freed electrons, flowing as plasma, accelerate in opposite directions, collide with other atoms, knock out more electrons, and, yes, occasionally produce new chemical elements!¹ Collisions generate so much heat that even more atoms lose electrons. A plasma flow is like an avalanche of snow; once it begins, it continues as long as there are flowing electrical charges (loose snow) and a high voltage (steep mountain slope). Within the fluttering granite crust at the beginning of the flood, **the piezoelectric effect** (which will soon be explained) generated high enough voltages to initiate plasma flows—electrical breakdowns—within the crust and fusion which produced new chemical elements, many radioactive.

Figure 202: Arcs and Sparks at the Sandia National Laboratory. Electrical charges, flowing within the plasma, act as if they are flowing in trillions of nearly parallel, closely packed wires. Each moving charge creates a magnetic field that cuts across nearby “wires,” producing a force that steadily squeezes charges toward each other. (This same force drives electric motors.) A high burst of current² through parallel wires produces a powerful force, called the **Z-pinch**, which pinches the wires together. In the Z-pinch machine at the right, the electrical surge vaporizes the wires and creates a plasma. The Z-pinch then tends to fuse atomic nuclei together. Nuclear engineers at Sandia are using this extremely powerful compressive force in plasmas to try to make a fusion reactor. If this or other technologies succeed, the world will have inexhaustible amounts of cheap, clean electrical energy.³ This chapter will show that powerful electrical discharges within the Earth's crust during the global flood quickly produced Earth's radioactivity and—based on today's extremely slow decay rates—billions of years' worth of radioactive decay products.



A helpful introduction to this chapter is Bryan Nickel's 37-minute, partially animated, PowerPoint presentation “Hydroplate Theory: The Origin of Earth’s Radioactivity.” It and other programs can be seen by going to www.youtube.com/c/BryanNickel_Hydroplate

The Origin of Earth’s Radioactivity

SUMMARY: *As the flood began, stresses in the massive fluttering crust generated huge piezoelectric voltages.⁴ For weeks, powerful electrical surges within Earth’s crust—much like bolts of lightning—produced equally powerful magnetic forces that squeezed (according to Faraday’s Law) atomic nuclei together into highly unstable, superheavy elements that quickly fissioned and decayed into subatomic particles and various isotopes, some of which were radioactive.*

Each step in this process is demonstrable on a small scale. Calculations and other evidence show that these events happened on a global scale.⁵ To quickly understand what happened, see “Earthquakes and Electricity” on page 387, and Figure 203 on page 380.

Evolutionists say Earth’s radioactive material evolved in stars and their exploded debris. Billions of years later, the Earth formed from that debris. Few of the theorized steps can be demonstrated experimentally. Observations on Earth and in space support the hydroplate explanation for Earth’s radioactivity, but refute the evolution explanation.

To contrast and evaluate these radically different explanations for the origin of Earth’s radioactivity, we will first explain some terms. With that background, new and surprising experimental evidence will become clear. Next, the two competing theories will be summarized: **the hydroplate theory** and **the chemical evolution theory**. Readers can then judge for themselves which theory better explains the evidence. First, we need to understand a few terms concerning the atom.

The Atom. Descriptions and models of the atom differ. What is certain is that no model proposed so far is completely correct.⁶ Fortunately, we need not consider these uncertainties here. Let us think of an atom as simply a **nucleus** surrounded by one or more shells—like layers of an onion. Each shell can hold a certain number of negative charges called **electrons**. (The innermost shell, for example, can hold two electrons.) The tightly packed,

vibrating nucleus contains **protons**, each with a positive charge, and **neutrons**, with no charge. (Protons and neutrons are called **nucleons**.)

An atom is small. Two trillion (2,000,000,000,000, or 2×10^{12}) carbon atoms would fit inside the period at the end of this sentence. A nucleus is even smaller. If an atom were the size of a football field, its nucleus—which contains about 99.98% of an atom’s mass—would be the size of a tiny seed! Electrons are smaller yet. An electron is to a speck of dust as a speck of dust is to the Earth!

Atoms of the same chemical element have the same number of protons. For example, a hydrogen atom has one proton; helium, two; lithium, three; carbon, six; oxygen, eight; iron, 26; gold, 79; and uranium, 92. Today, Earth has 94 naturally occurring chemical elements.⁷

A carbon-12 atom, by definition, has exactly 12.000000 **Atomic Mass Units (AMU)**. If we could break a carbon-12 atom apart and “weigh” each of its six protons, six neutrons, and six electrons, the sum of their masses would be 12.098940 AMU—which is 0.098940 AMU heavier than the carbon-12 atom itself. To see why *an atom weighs less than the sum of its parts*, we must understand **binding energy**.

Table 22. Mass of Carbon-12 Components

Subatomic Particle	Charge	Mass of Each (AMU)	Mass of All Six (AMU)
proton	positive	1.007276	6.043656
neutron	none	1.008665	6.051990
electron	negative	0.000549	0.003294

TOTAL: 12.098940

A carbon-12 atom’s mass is exactly 12.000000 AMU—by definition. In building a carbon-12 atom from 6 protons, 6 neutrons, and 6 electrons:
 Loss of Mass (m) = 12.098940 - 12.000000 = 0.098940 AMU
 Gain of Binding Energy (E) = 0.098940 AMU \times c^2
 $E = m c^2$
 where $c = 186,000$ miles per second (the velocity of light).

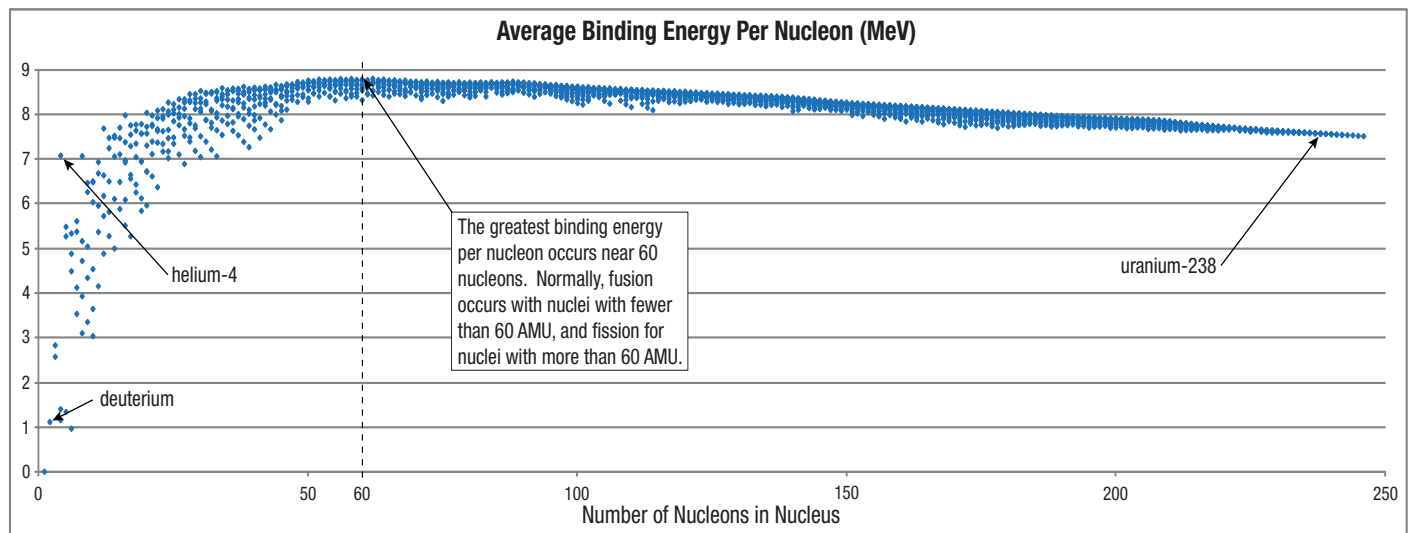

Figure 203: Binding Energy. When separate nucleons (protons and neutrons) come together to form a nucleus, a tiny percentage of their mass instantly disappears and becomes a large amount of energy. That energy (usually measured in units of Millions of electron Volts, or MeV) is called *binding energy*, because a powerful force—appropriately called the *strong force*—tightly *binds* the nucleons together—snaps them powerfully together—producing a burst of heat. Binding energy is also the energy required to unbind a nucleus or cluster of nucleons into their separate protons and neutrons.

For example, a deuterium (hydrogen-2) nucleus contains a proton and a neutron. Its nucleus has a total binding energy of about 2.2 MeV, so the average binding energy per nucleon is about 1.1 MeV. If two deuterium nuclei merge to become helium, 2.2 MeV + 2.2 MeV of binding energy per nucleon are replaced by helium-4's average binding energy of 7.1 MeV per nucleon, or a total of 4×7.1 MeV. The gain in binding energy becomes emitted heat. This *merging* of light nuclei is called *fusion*. The Sun produces most of its heat by the fusion of deuterium into helium.⁸ The peak of the binding energy curve (above) is around 60 AMU (near iron), so fusion normally⁹ merges into nuclei lighter than 60 AMU. ***Fusion that forms elements heavier than 60 AMU absorbs energy.***

Fission is the *splitting* of heavy nuclei. For example, when uranium fissions, the sum of the binding energies of the fragments is greater than the binding energy of the uranium nucleus, so energy is released. Fission (as well as fusion) will continue only if energy is released to generate more fission (or fusion).

The closer the mass of a nucleus is to the mass of an iron or nickel nucleus (60 AMU), the more binding energy that nucleus has per nucleon. [Study Figure 203.] Let's say that a very heavy nucleus, such as a uranium nucleus weighing 235.0 AMU, splits (fissions) into two nuclei weighing 100.0 AMU and 134.8 AMU and a neutron (0.1 AMU). The 0.1 AMU of lost mass is converted to energy, according to Einstein's famous equation, $E = mc^2$, where c is the speed of light (186,000 miles per second), and E is the energy released when a mass m is converted to energy. The energy is great, because c^2 is huge. (For example, when an atomic bomb destroyed Hiroshima, only about 700 milligrams of mass—about one-third the mass of a U.S. dime—was converted to energy.) Nuclear energy is usually released as kinetic energy. The high-velocity fragments generate heat as they slow down during multiple collisions.

Sometimes, a very heavy nucleus splits, a process called ***fission***. Fission may occur when a neutron, or even a high-energy ***photon*** (particle of light) hits a heavy nucleus. When fission happens spontaneously—without being hit—it is a type of decay. When fission occurs, mass is lost and energy is released. Likewise, when light nuclei merge (a process called ***fusion***), mass is lost, and energy is released. In an atom bomb, uranium or plutonium nuclei split (fission). In a hydrogen bomb, hydrogen nuclei merge (fuse) to become helium.

Fission inside nuclear reactors produces many free neutrons. Water is an excellent substance for absorbing the energy of fast neutrons and thereby producing heat, because water is cheap and contains so much hydrogen. (A hydrogen atom has about the same mass as a neutron, so hydrogen quickly absorbs a fast neutron's kinetic energy.) The heat can then boil water to produce steam that spins a turbine and generates electricity.

Isotopes. Chemical elements with the same number of protons but a different number of neutrons are called *isotopes*. Every chemical element has several isotopes, although most are seen only briefly in experiments. Carbon-12, carbon-13, and carbon-14 are different isotopes of carbon. All are carbon, because they have 6 protons, but respectively, they have 6, 7, and 8 neutrons—or 12, 13, and 14 nucleons. The number of protons determines the chemical element; the number of neutrons determines the isotope of the element.

Radioactivity. Most isotopes are radioactive; that is, their vibrating, unstable nuclei sometimes change spontaneously (decay), usually by emitting fast, very tiny particles—even photons (particles of light) called gamma rays. Each decay, except gamma emission, converts the nucleus into a new isotope, called the daughter. One type of radioactive decay occurs when a nucleus expels an alpha particle—a tight bundle of two protons and two neutrons, identical to the nucleus of a helium atom. In another type of decay,

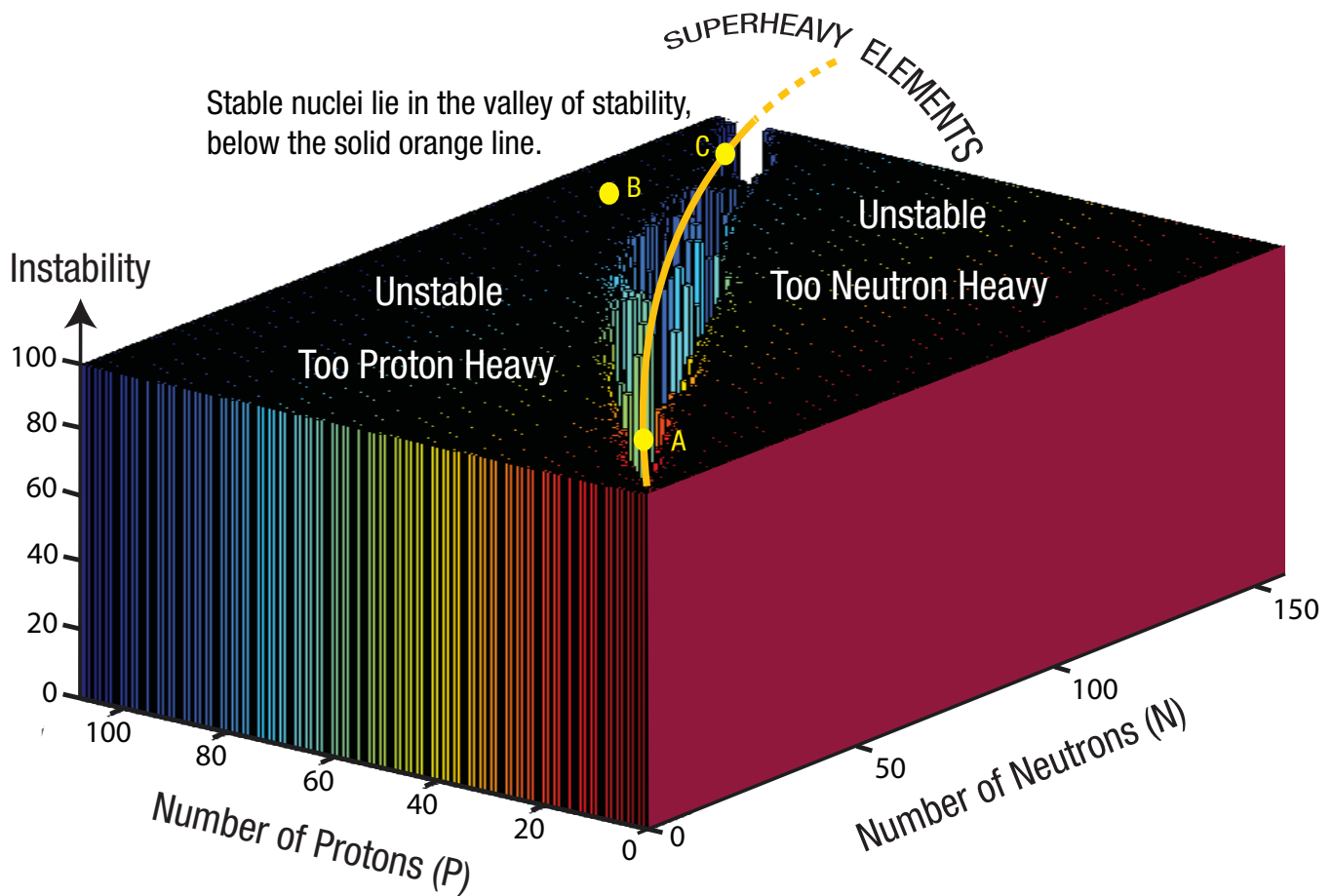

Figure 204: Valley of Stability. Each of the more than 3,100 known isotopes is defined by two numbers: the number of protons (P) and the number of neutrons (N). Think of each isotope as occupying a point on a horizontal P - N coordinate system. A thin, vertical bar represents each isotope's stability: tall bars for isotopes that decay rapidly, shorter bars for isotopes with longer half-lives, and no vertical bars for stable isotopes.¹⁰ Almost 300 stable isotopes are represented far below the curved orange line, in what is called *the valley of stability*. It lies near the diagonal between the P axis and the N axis.

Almost all isotopes represented by the high, flat "plateau" are so unstable they instantly decay. Most of the thousand or so isotopes briefly observed in experiments lie just below the edge of the "cliff" looking down into the valley. Those on the steep slope have half-lives of seconds to billions of years. Stable isotopes are down on the valley floor. (A billion year half-life does not mean the isotope is billions of years old. It simply means the isotope is fairly stable.)

Notice how the valley curves toward the right.¹¹ Light, stable nuclei have about the same number of protons as neutrons (such as carbon-12 with six protons and six neutrons.) Heavy nuclei that are stable have many more neutrons than protons. A key point to remember: if we could squeeze several light, stable nuclei together to make one heavy nucleus, it would lie high on the proton-heavy side of the valley, be radioactive, and would soon decay.

For example, if some powerful compression or the Z -pinch (described in Figure 202 on page 378) suddenly merged (fused) six stable nuclei near point A, the resulting heavy nucleus would lie at point B, where it would quickly decay or fission.¹² Merged nuclei that were even heavier—*superheavy* nuclei—would momentarily lie far beyond point B, but would instantly fission—fragment into many of our common chemical elements—sometimes uranium. If the valley of stability were straight and did not curve, stable nuclei that fused together would form a *stable*, heavy nucleus (i.e., would still lie on the valley floor). Nuclei near C that fission will usually produce neutron-heavy products. As you will see, because the valley curves, we have radioactivity—another key point to remember. (Soon, you will read about the "strong force" which produces binding energy and causes the valley to curve.)

All Earth's nuclei were initially nonradioactive, lying at the bottom of the curved valley of stability—a "very good" condition (Genesis 1:31), because radioactivity damages living organisms. During the early weeks of the flood, chaotic discharges of electrons, driven by billions of volts of electricity, pulsed through the Earth's crust, producing radioactive isotopes, and their decay products. How this happened will soon be explained. We can think of these new isotopes as being scattered high on the sides of the valley of stability.

It would be as if a powerful explosion, or some sudden release of energy, blasted rocks up onto the steep sides of a long valley. Most rocks would quickly roll back down and dislodge somewhat unstable rocks that were part way up the slope. Today, rocks rarely roll down the sides of the valley. **Wouldn't it be foolish to assume that the rubble at the bottom of this valley must have been accumulating for billions of years, merely because it would take billions of years for all that rubble to collect at the very slow rate rocks roll downhill today?**

Later in this chapter, you will see the well-established physical processes that—in less than 1 hour—greatly accelerated radioactive decay during the flood.

beta decay, a neutron suddenly emits an electron and becomes a proton. Electron capture, a type of decay, is beta decay in reverse; that is, an atom's electron enters the nucleus, combines with a proton, and converts it into a neutron. Few scientists realize that on rare occasions heavy nuclei will decay by emitting a carbon-14 nucleus (^{14}C).¹³ **This invalidates the basic assumptions of the radiocarbon dating technique.** [See “How Accurate Is Radiocarbon Dating?” on pages 523–527.]

Radioisotopes. Radioactive isotopes are called *radioisotopes*. Only about 65 naturally occurring radioisotopes are known. However, high-energy processes (such as those occurring in atomic explosions, atomic accelerators, and nuclear reactors) have produced about 3,000 different radioisotopes, including a few previously unknown chemical elements. One, **Proto-Uranium**, which is now extinct, was the heaviest chemical element known. Its discovery will soon be explained.

Decay Rates. Each radioisotope has a *half-life*—the time it takes for half of a large sample of that isotope to decay at today's rate. Half-lives range from less than a billionth of a second to many millions of trillions of years.¹⁴ Most attempts to change decay rates have failed. For example, changing temperatures from -427°F to $+4,500^\circ\text{F}$ produces no measurable change in decay rates. Nor have accelerations of up to 970,000 g, magnetic fields up to 45,000 gauss, or changing elevations or chemical concentrations.

However, we knew as far back as 1971 that high pressure could increase decay rates very slightly for at least 14 isotopes.¹⁵ Under great pressure, electrons (especially from the innermost shell) are squeezed closer to the nucleus, making electron capture more likely. Also, electron capture rates for a few radioisotopes change in different chemical compounds.¹⁶

Beta decay rates can increase dramatically when atoms are stripped of all their electrons. In 1999, Germany's Dr. Fritz Bosch showed that, for the rhenium atom, this “*decreases its half-life more than a billionfold—from 42-billion years to 33 years.*”¹⁷ The more electrons removed, the more rapidly neutrons expel electrons (beta decay) and become protons. This effect was previously unknown, because only electrically neutral atoms had been used to measure half-lives.¹⁸

Decay rates for silicon-32 (^{32}Si), chlorine-36 (^{36}Cl), manganese-54 (^{54}Mn), and radium-226 (^{226}Ra) depend slightly on Earth's distance from the Sun.¹⁹ They decay, respectively, by beta, alpha, and electron capture. Other radioisotopes are similarly affected. This may be an electrical effect or a consequence of neutrinos²⁰ flowing from the Sun.

Major corporations hold patents for electrical devices that on a small scale accelerate alpha, beta, and gamma decay, thereby decontaminating hazardous nuclear wastes. An interesting patent awarded to William A. Barker is described as follows:²¹

When a Van de Graaff generator generates 50,000 – 500,000 volts across radioactive material for at least 30 minutes, alpha, beta, and gamma particles sometimes escape. This large negative voltage is thought to lower each nucleus' energy barrier.

While these electrical devices can safely decontaminate hazardous radioactive material by accelerating decay rates, they are expensive and have decontaminated only small samples. Many nuclear scientists do not understand why they work, but a few pages you will. Clearly, *the common belief that decay rates are constant in all conditions is false.*

We can think of a large sample of a radioisotope as a slowly-leaking balloon with a meter that measures the balloon's total leakage since it was filled. Different radioisotopes have different leakage rates, or half-lives. (Stable isotopes do not leak; they are not radioactive.)

Some may think that a balloon's age can be determined by dividing the balloon's total leakage by its leakage rate today. Here, we will address more basic issues: What “pumped up” all radioisotopes in the first place, and when did it happen? Did the pumping process rapidly produce considerable initial leakage—billions of years' worth, based on today's slow leakage rates?

Neutron Activation Analysis. This routine, nondestructive technique is used to identify unknown chemical elements. Neutrons, usually from a nuclear reactor, bombard the unknown material. Some nuclei absorb neutrons and become radioactive—are driven up the neutron-heavy side of the valley of stability. [See Figure 204 on page 381.] The decay characteristics of those “pumped up” nuclei then help identify the atoms present.

Neutron Stars. When a very massive star begins to run out of hydrogen and other nuclear fuels, it can collapse so suddenly that almost all its electrons are driven into nuclei. This produces a “sea of neutrons” and releases the immense energy of a **supernova**. What remains near the center of the gigantic explosion is a dense star, about 10 miles in diameter, composed of neutrons—a neutron star.

The Strong Force. Like charges repel each other, so what keeps a nucleus containing many positively charged protons from flying apart? A poorly understood force inside the nucleus acts over a very short distance to pull protons and neutrons together. Nuclear physicists call this *the strong force*. Binding energy, described in Figure 203, is the result of work done by the strong force.

Two nuclei, pushed toward each other, initially experience an increasing repelling force, called the **Coulomb force**, because both nuclei have positive charges. However, if a voltage is accelerating many nuclei in one direction and electrons are flowing between them in the opposite direction, the intervening electrons largely cancel the repelling force. Furthermore, both positive and negative flows will

reinforcing the Z-pinch. [See [Figure 202](#) on page 378.] If the voltage driving both flows is large enough, the Z-pinch brings the two nuclei close enough together so that the strong force merges them into one large nucleus.²²

If the Z-pinch acts over a broad plasma flow, many nuclei could merge into *superheavy nuclei*—nuclei much heavier than any chemical element found naturally. Most merged nuclei would be unstable (radioactive) and would rapidly decay, because they would lie *high on the proton-heavy side of the valley of stability*. [See [Figure 203](#) on page 380.]

While the strong force holds nuclei together and overcomes the repelling Coulomb force, four particular nuclei are barely held together: lithium-6 (${}^6\text{Li}$), beryllium-9 (${}^9\text{Be}$), boron-10 (${}^{10}\text{B}$), and boron-11 (${}^{11}\text{B}$). Slight impacts will cause their decay.²³ The importance of these fragile isotopes will soon become clear.

Free Neutrons. Neutrons in a nucleus rarely decay, but free neutrons (those outside a nucleus) decay with a half-life of about 14.7 minutes! Why would a neutron inside a nucleus have a half-life of millions of years, but, when isolated, have a half-life of minutes?²⁴ This is similar to what Fritz Bosch discovered: When an intense electric field strips electrons surrounding certain heavy nuclei, those nuclei become so unstable that their decay rate increases, sometimes a billionfold.

Carbon-14. Each year, cosmic radiation striking the upper atmosphere converts about 21 pounds of nitrogen-14 into carbon-14, also called *radiocarbon*. Carbon-14 has a half-life of 5,730 years. Radiocarbon dating has become much more precise, by using *Accelerator Mass Spectrometry (AMS)*, a technique that counts individual carbon-14 atoms. AMS ages for old carbon-14 specimens are generally about 5,000 years. [See “[How Accurate Is Radiocarbon Dating?](#)” on pages 506–509.] AMS sometimes dates the same materials that were already dated by older, less-precise radiometric dating techniques. In those cases, AMS ages are usually 10–1000 times younger.²⁵

Argon-40. About 1% of Earth's atmosphere (not counting water vapor) is argon, of which 99.6% is argon-40 and only 0.3% is argon-36. Both are stable. Today, argon-40 is produced almost entirely by electron capture in potassium-40. In 1966, Melvin Cook pointed out the enormous discrepancy in the large amount of argon-40 in our atmosphere, the relatively small amount of potassium-40 in the Earth's crust, and its slow rate of decay (half-life: 1.3-billion years).

The Earth would have to be about 10^{10} years old [10-billion years, twice what evolutionists believe] and the initial ${}^{40}\text{K}$ [potassium-40] content of the Earth about 100 times greater than at present ... to have generated the ${}^{40}\text{Ar}$ [argon-40] in the atmosphere.²⁶

Since Cook published that statement, estimates of the amount of ${}^{40}\text{K}$ in the Earth have increased. Nevertheless, a glaring contradiction remains. Despite geophysicists'

efforts to juggle the numbers, the small amount of ${}^{40}\text{K}$ in the Earth is not enough to have produced all the ${}^{40}\text{Ar}$, the fourth most abundant gas in the atmosphere (after nitrogen, oxygen, and water vapor). If ${}^{40}\text{Ar}$ was produced by a process other than the slow decay of ${}^{40}\text{K}$, as the evidence indicates, then the potassium-argon and argon-argon dating techniques, the most frequently used radiometric dating techniques,²⁷ become useless, if not deceptive.

Likewise, Saturn's icy moon Enceladus has little ${}^{40}\text{K}$, but is jettisoning too much ${}^{40}\text{Ar}$ into space from its south pole. Enceladus would need a thousand times its current rock content consisting of the most favorable types of meteorites to explain all of its argon-40.²⁸ Even with that much ${}^{40}\text{K}$, how would the argon rapidly escape from the rock and be concentrated? In the previous chapter, we saw that Enceladus and other irregular moons in the solar system are captured asteroids, whose material was expelled from Earth by the fountains of the great deep. Could all that ${}^{40}\text{Ar}$ have been produced in the subterranean chamber and expelled as part of the debris? Enceladus also contains too much deuterium—about the same amount as in almost all comets and more than ten times the concentration found in the rest of the solar system.²⁹ The comet chapter listed this as one of seventeen major reasons for concluding that the material in comets was launched from Earth by the fountains of the great deep.

One final point: Micrometeorites and solar wind add at least seven times more ${}^{36}\text{Ar}$ than ${}^{40}\text{Ar}$ to Earth's atmosphere. Therefore, those sources provided little of the Earth's ${}^{40}\text{Ar}$,³⁰ because, as stated above, our atmosphere has about 300 times more ${}^{40}\text{Ar}$ than ${}^{36}\text{Ar}$.

Potassium-40 and Carbon-14. Potassium-40 is the most abundant *radioactive* substance in the human body and every living thing. (Yes, your body is slightly radioactive!) Fortunately, potassium-40 decays by expelling a not-very-penetrating electron (beta decay). Nevertheless, when potassium-40 decays, it becomes calcium, so if the tiny electron “bullet” didn't damage you, the sudden change from potassium to calcium could be quite damaging—almost as if a screw in a complex machine suddenly became a nail. While only one ten-thousandth of the potassium atoms in living things is potassium-40, most have already decayed, so living things were at greater risk in the past. *How could life have evolved if it had been radioactive?*

That question also applies for the rare radioactive isotopes in the chemical elements that are in DNA, such as carbon-14. DNA is the most complex material known. A 160-pound person experiences 2,500 carbon-14 disintegrations each second, almost 10 of which occur each second in the person's DNA! [See [Endnote 4](#) on page 512.]

The answer to this question is simple. Life did not evolve, and Earth's radioactivity was not present when life began. Earth's radioactivity is a consequence of the flood. [See “[Mutations](#)” on page 7.]

Nuclear Combustion

Since February 2000, thousands of sophisticated experiments at the Proton-21 Electrodynamics Research Laboratory (Kiev, Ukraine) have demonstrated *nuclear combustion*³¹ by producing traces of all known chemical elements and their stable isotopes.³² In those experiments, a brief (10^{-8} second), 50,000-volt electron flow, at relativistic speeds, self-focuses (Z-pinches) inside a hemispherical electrode target, typically 0.5 mm in diameter. The relative abundance of chemical elements produced generally corresponds to what is in the Earth's crust.

*... the statistical mean curves of the abundance of chemical elements created in our experiments are close to those characteristic in the Earth's crust.*³³

Each experiment uses one of 22 separate electrode materials, including copper, silver, platinum, bismuth, and lead, each at least 99.90% pure. In a typical experiment, the energy of an electron pulse is less than 300 joules (roughly 0.3 BTU or 0.1 watt-hour), but it is focused—Z-pinched—onto a point inside the electrode. That point, where all the electrical energy is concentrated, instantly becomes the center of a tiny sphere of dense plasma.

With a burst of more than 10^{18} electrons flowing through the center of this plasma sphere, the surrounding nuclei (positive ions) implode onto that center. Compression from this implosion easily overcomes the normal Coulomb repulsion between the positively charged nuclei. The resulting fusion produces **superheavy chemical elements**, some twice as heavy as uranium and some that last for a few months.³⁴ All eventually fission, producing a wide variety of new chemical elements and isotopes.

For an instant, temperatures in this “hot dot” (less than one ten-millionth of a millimeter in diameter) reach 3.5×10^8 K—an energy density greatly exceeding that of a supernova! The electrodes rupture with a flash of light, including x-rays and gamma rays. [See Figure 206.] Also emitted are alpha and beta particles, plasma, and dozens of transmuted chemical elements. The total energy in this “hot dot” is about four orders of magnitude greater than the electrical energy input! However, as explained in Figure 203 on page 380, *the heat is absorbed by elements heavier than iron that are produced by fusion. Therefore, the entire experiment produces little heat.* The new elements result from a “cold repacking” of the nucleons of the target electrode.³⁵

Dr. Stanislav Adamenko, the laboratory's scientific director, believes that these experiments are microscopic analogs of events occurring in supernovas and other phenomena involving *Z-pinched electrical pulses*.³⁶



Figure 205: Preparing for a Demonstration of Nuclear Combustion at the Proton-21 Laboratory.



Figure 206: Ruptured Electrode. This disk (0.02 of an inch in diameter) is a slice of one of the thousands of electrodes that ruptured when a self-focused, relativistic electron beam pinched into a 630,000,000°F “hot dot” that was only 4 billionths of an inch in diameter. The focused heat was enough to melt a piece of rock a few millimeters in diameter. [See “Chondrules” on page 410.] Decay fragments and new chemical elements were splattered onto an accumulating screen for later analysis by a mass spectrometer.

The Proton-21 Laboratory has patented this technology in Europe, Japan, and the United States and collaborates with other properly equipped laboratories that wish to duplicate these results or examine specimens.

Zircons. Zircons are tiny, durable crystals about twice the thickness of a human hair. They usually contain small amounts of uranium and thorium, some of which is assumed to have decayed, at today's very slow rates, to lead. If this is true, zircons are extremely old. For example, hundreds of zircons found in Western Australia would be 4.0–4.4-billion years old. Most evolutionists find this puzzling, because they have claimed that the Earth was largely molten prior to 3.9-billion years ago!³⁷ These zircons also contain tiny inclusions of quartz, which suggests that the quartz was transported in and precipitated out of liquid water; if so, the Earth was relatively cool and had a granite crust.³⁸ Other zircons, some supposedly as old as 4.42-billion years, contain microdiamonds with abnormally low, but highly variable amounts of ¹³C. These microdiamonds apparently formed (1) under unusual geological conditions, and (2) under extremely high, and perhaps sudden, pressures *before* the zircons encased them.³⁹

Helium Retention in Zircons. Uranium and thorium usually decay by emitting alpha particles. Each alpha particle is a helium nucleus that quickly attracts two electrons and becomes a helium atom (⁴He). The helium gas produced in zircons by uranium and thorium decay should diffuse out relatively quickly, because helium does not combine chemically with other atoms, and it is extremely small—the second smallest of all elements by mass, and the smallest by volume!

Some zircons would be 1.5-billion years old if the lead in them accumulated at *today's* rate. But based on the rapid diffusion of helium out of zircons, the lead would have been produced in the last 4,000–8,000 years⁴⁰—a clear contradiction, suggesting that at least one time in the past, rates were faster.

Helium-3 (³He). Ejected alpha particles, as stated above, quickly become ⁴He, which constitutes 99.999863% of the Earth's detectable helium. *Only nuclear reactions produce ³He*, the remaining 0.000137% of Earth's known helium. Today, no nuclear reactions are known to produce ³He inside the Earth. Only the hydroplate theory explains how nuclear reactions produced ³He at one time (during the flood) inside the solid Earth (in the fluttering crust).⁴¹

³He and ⁴He are stable (not radioactive). Because nuclear reactions that produce ³He are not known to be occurring inside the Earth, some evolutionists say that ³He must have been primordial—present before the Earth evolved. Therefore, ³He, they say, was trapped in the infalling meteoritic material that formed the Earth. But helium does not combine chemically with anything, so how did such a light, volatile gas get inside meteorites? If helium was trapped in falling meteorites, why did it not quickly escape or bubble out when meteorites supposedly crashed into the molten, evolving Earth?⁴² Even if ³He atoms were produced inside the Earth, and the mantle has been circulating and mixing for billions of years, why do different volcanoes

expel drastically different amounts of ³He, and why—as explained in Figure 55 on page 124—are black smokers expelling large amounts of ³He?⁴³ Indeed, the small amount of ³He should be so thoroughly mixed and diluted in the circulating mantle that it should be undetectable.⁴⁴

Where Is Earth's Radioactivity? Three types of measurements each show that Earth's radioactivity is concentrated in the relatively thin continental (granite) crust. In 1906, some scientists recognized that just heat from the radioactivity in the granite crust should explain all the heat now coming out of the Earth. If radioactivity were occurring *below* the crust, even more heat should escape. Because it is not, radioactivity should be concentrated in the top “few tens of kilometers” of the Earth—and have begun recently.

*The distribution of radioactive material with depth is unknown, but amounts of the order of those observed at the surface must be confined to a relatively thin layer below the Earth's surface of the order of a few tens of kilometers in thickness, otherwise more heat would be generated than can be accounted for by the observed loss from the surface.*⁴⁵

Later, holes drilled into the ocean floor showed slightly more heat coming up through the ocean floors than through the continents. But basaltic rocks under the ocean floor contain little radioactivity.⁴⁶ Therefore, radioactive decay is not the main source of Earth's geothermal heat.

The second type of measurement occurred in Germany's Deep Drilling Program. The concentration of radioactivity measured down Germany's deepest hole (5.7 miles) would account for all the heat flowing out at the Earth's surface if that concentration continued down to a depth of only 18.8 miles and if the crust were 4-billion years old.⁴⁷

However, the rate at which temperatures increased with depth was so great that if the trend continued, the rock at the top of the mantle should be partially melted. Seismic studies have shown that this is not the case.⁴⁸ Therefore, temperatures do not continue increasing down to the mantle, so the heating occurred in the Earth's crust.

The third measurement technique, used in regions of the United States and Australia, shows a strange, but well-verified, correlation: *the amount of heat flowing out of the Earth at specific locations correlates with the radioactivity in surface rocks at those locations.* Wherever radioactivity is high, the heat flow will usually be high; wherever radioactivity is low, the heat flow will often be low. *However, the radioactivity at those hotter locations is far too small to account for that heat.*⁴⁹ What does this correlation mean?

First, consider what it does not necessarily mean. When two sets of measurements correlate (or correspond), people often mistakenly conclude that one of the things measured (such as radioactivity in surface rocks at one location) *caused* the other thing being measured (surface heat flow at that location). Even experienced researchers sometimes make this mistake.

Students of statistics are repeatedly warned “that *correlation does not imply causation*,” and are shown hundreds of humorous⁵⁰ and tragic examples of this common mistake in logic. Nevertheless, the problem abounds in all research fields.

This correlation could be explained if most of the heat flowing up through Earth’s surface was generated, not by radioactivity, but by the events that produced that radioactivity. If more heat is coming out of the ground at one place, then more radioactivity was also produced there. Therefore, radioactivity in surface rocks would correlate with surface heat flow.

The Oklo Natural “Reactor.” Building a nuclear reactor requires the careful design of many interrelated components. Reactors generate heat by the controlled fission of certain isotopes, such as uranium-235 (^{235}U). For reasons that have remained hidden until now, 0.72% of almost every uranium ore deposit in the world is ^{235}U . About 99.27% is the more stable ^{238}U , and 0.01% is ^{234}U . The hydroplate theory’s explanation for the origin of Earth’s radioactivity will explain why this is so in a few pages.) ^{235}U reactors require ^{235}U concentrations of at least 3–5%. This enrichment is both expensive and technically difficult.

Controlling the reactor is a second requirement. When a neutron splits a ^{235}U nucleus, heat and typically two or three other neutrons are released. If the ^{235}U is sufficiently concentrated and, on average, exactly one of those two or three neutrons fissions another ^{235}U nucleus, the reaction continues and is said to be *critical*—or self-sustaining. If this delicate situation can be maintained, considerable heat (from binding energy) is steadily released, usually for years.

Logical Conclusions

Because Earth’s radioactivity is concentrated in the crust, three corollaries (or other conclusions) follow:

1. **The Earth did not evolve.** Had the Earth evolved from a swirling dust cloud (“star stuff”), radioactivity would be spread throughout the Earth. It is not.
2. **Supernovas did not produce Earth’s radioactivity.** Had supernovas spewed out radioisotopes in our part of the galaxy, radioactivity would be spread throughout the Earth. Again, it is concentrated in continental granite.
3. **The Earth was never molten.** Had the Earth ever been molten, denser elements and minerals (such as uranium and zircons) would have sunk toward the center of the Earth. Instead, they are at the Earth’s surface.

In 1972, French engineers were processing uranium ore from an open-pit mine near the Oklo River in the Gabon Republic on Africa’s west equatorial coast. There, they discovered depleted (partially consumed) ^{235}U in isolated zones.⁵¹

(In one zone, only 0.29% of the uranium was ^{235}U , instead of the expected 0.72%.) Many fission products from ^{235}U were also mixed with the depleted ^{235}U but found nowhere else.

Nuclear engineers, aware of just how difficult it is to design and build a nuclear reactor, are amazed by what they believe was a naturally occurring reactor. But notice, we do not know that a self-sustaining, critical reactor operated at Oklo. All we know is that *considerable ^{235}U has fissioned*.

How could this have happened? Suppose, as is true for every other known uranium mine, Oklo’s uranium layer was never critical. That is, for every 100 neutrons produced by ^{235}U fission, 99 or fewer other neutrons were produced in the next fission cycle, an instant later. The nuclear reaction would quickly die down; i.e., it would not be self-sustaining. However, suppose (as will soon be explained) many free neutrons frequently appeared somewhere in the uranium ore layer. Although the nuclear reaction would not be self-sustaining, the process would multiply the number of neutrons available to fission ^{235}U .⁵² This would better match what is found at Oklo for four reasons.

First, in several “reactor” zones the ore layer was too thin to become critical. Too many neutrons would have escaped or been absorbed by all the nonfissioning material (called *poisons*) mixed in with the uranium.⁵³

Second, one zone lies 30 kilometers from the other zones. Whatever strange events at Oklo depleted ^{235}U in 16 largely separated zones was probably common to that region of Africa and not to some specific topography. Uranium deposits are found in many diverse regions worldwide, and yet, only in the Oklo region has this mystery been observed.

Third, depleted ^{235}U was found where it should not be—near the borders of the ore deposit, where neutrons would tend to escape, instead of fission ^{235}U . Had Oklo been a reactor, depleted ^{235}U should be concentrated near the center of the ore body.⁵⁴

Fourth, at Oklo, the ratio of ^{235}U to ^{238}U in uranium ore, which should be about 0.72 to 99.27 (or 1 to 138), surprisingly varies *a thousandfold* over distances as small as 0.0004 inch (0.01 mm)!⁵⁵ A. A. Harms has explained that this wide variation

*represents strong evidence that, rather than being a [thermally] static event, Oklo represented a highly dynamic—indeed, possibly “chaotic” and “pulsing”—phenomenon.*⁵⁶

Harms also explained why rapid spikes in temperature and nuclear power altered the typical ratios of ^{235}U to ^{238}U over very short distances. The subject, “**Isotope Ratios**,” on page 409 will give a surprising reason why those ratios are normally fixed and what caused the spikes, years after the flood, that altered those ratios of ^{235}U to ^{238}U .

Earthquakes and Electricity

Books have been written describing thousands of strange electrical events that accompanied earthquakes.⁵⁷ Some descriptions of earthquakes worldwide include such phrases as: “flames shot out of the ground,” “intense electrical activity,” “the sky was alight,” “ribbon-like flashes of lightning seen through a dense mist,” “[a chain anchoring a boat became] incandescent and partly melted,” “lightning flashes,” “globes of fire and other extraordinary lights and illuminations,” “sheets of flame [waved to and fro for a few minutes] on the rocky sides of the Inyo Mountains,” “a stream of fire ran between both [of my] knees and the stove,” “the presence of fire on the rocks in the neighborhood,” “convulsions of magnetic compass needles on ships,” “indefinite instantaneous illumination,” “lightning and brightnings,” “sparks or sprinkles of light,” “thin luminous stripes or streamers,” “well-defined and mobile luminous masses,” “fireballs,” “vertical columns of fire,” “many sparks,” “individuals felt electrical shocks,” “luminous vapor,” “bluish flames emerged from fissures opened in the ground,” “flame and flash suddenly appeared and vanished at the mouth of the rent [crack in the ground],” “earthquakes [in India] are almost always accompanied by furious storms of thunder, lightning, and rain,” “electrical currents rushed through the Anglo-American cables [on the Atlantic floor] toward England a few minutes before and after the shocks of March 17th, 1871,” “[Charles] Lyell and other authors mentioned that the atmosphere before an earthquake was densely charged with electricity,” and “fifty-six links in the chains mooring the ship had the appearance of being melted. During the earthquake, the water alongside the chains was full of little bubbles; the breaking of them sounded like red-hot iron put into water.”

The three New Madrid Earthquakes (1811–1812), centered near New Madrid, Missouri, were some of the largest earthquakes ever to strike the United States. Although few people observed and documented them, the reports we do have are harrowing. For example:

Lewis F. Linn, United States Senator, in a letter to the chairman of the Committee on Commerce, says the shock, accompanied by “flashes of electricity, rendered the darkness doubly terrible.” Another evidently somewhat excited observer near New Madrid thought he saw “many sparks of fire emitted from the earth.” At St. Louis, gleams and flashes of light were frequently visible around the horizon in different directions, generally ascending from the earth. In Livingston County, the atmosphere previous to the shock of February 8, 1812, contained remarkable, luminous objects visible for considerable distances, although there was no moon. “On this occasion, the brightness was general and did not proceed from any point or spot in the heavens. It was broad and expanded, reaching from the zenith on every side toward the horizon. It exhibited no flashes, but, as long as it lasted, was a diffused illumination of the atmosphere on all sides.” At Bardstown, there are reported to have been “frequent lights during the commotions.” At Knoxville, Tennessee, at the end of the first shock, “two flashes of light, at intervals of about a minute, very much like distant lightning,” were observed. Farther east, in North Carolina, there were reported “three large extraordinary fires in the air; one appeared in an easterly direction, one in the north, and one in the south. Their continuance was several hours; their size as large as a house on fire; the motion of the blaze was quite visible, but no sparks appeared.” At Savannah, Georgia, the first shock is said to have been preceded by a flash of light.⁵⁸

Why does so much electrical activity accompany many large earthquakes? Are frightened people hallucinating? Does electrical activity cause earthquakes, or do earthquakes cause electrical activity? Maybe something else produces both electrical activity and earthquakes. Does all this relate to the origin of Earth's radioactivity?

Radiohalos. An alpha particle shot from a radioisotope inside a rock acts like a tiny bullet crashing through the surrounding crystalline structure. The “bullet” travels for a specific distance (usually a few ten-thousandths of an inch) depending on the particular radioisotope and the hardness of the crystals it penetrates. If a billion copies of the same radioisotope are clustered near a microscopic point, their randomly directed “bullets” will begin to form a tiny sphere of discoloration and radiation damage called a *radiohalo*.⁵⁹

For example, ^{238}U , after a series of eight alpha decays (and six much less-damaging beta decays), will become lead-206 (^{206}Pb). Therefore, eight concentric spheres, each with a slightly different color and radius, will

surround what was a point concentration of a billion ^{238}U atoms. Under a microscope, those radiohalos look like the rings of a tiny onion. [See Figure 207.] A thin slice through the center of this “onion” resembles a bull's-eye target at an archery range. Each ring's relative size identifies the radioisotope that produced it.

Isolated Polonium Halos. We can think of the eight alpha decays from ^{238}U to ^{206}Pb as eight rungs on a generational ladder. Each alpha decay leads to the radioisotope on the ladder's next lower rung. The last three alpha decays⁶¹ are of the chemical element polonium (Po): ^{218}Po , ^{214}Po , and ^{210}Po . Their half-lives are extremely short: 3.1 minutes, 0.000164 seconds, and 138 days, respectively.

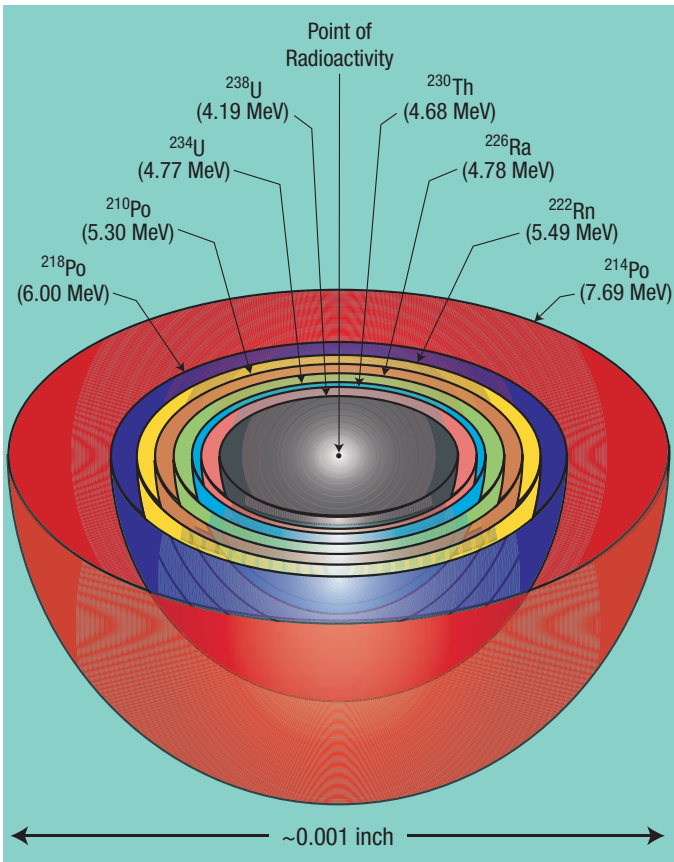

Figure 207: Radiohalos from the ^{238}U Decay Series. Suppose many ^{238}U atoms were concentrated at the point of radioactivity shown here. Each ^{238}U atom eventually ejects one alpha particle in a random direction, but at the specific velocity corresponding to 4.19 million electron volts (MeV) of energy—the binding energy released when ^{238}U decays. That energy determines the distance traveled, so each alpha particle from ^{238}U ends up at the gray spherical shell shown above. (Alpha particles from daughter isotopes will travel to different shells.) Each sharply defined halo requires the ejection of about a billion alpha particles from the common center of all halos, because each alpha particle leaves such a thin path of destruction.

A ^{238}U atom becomes ^{234}U after the alpha decay and two less-damaging beta decays. Later, that ^{234}U atom expels an alpha particle with 4.77 MeV of kinetic energy. As a billion ^{234}U atoms decay, a sharp ^{234}U halo forms. Eventually, a billion lead-206 (^{206}Pb) atoms will occupy the halo center, and each halo's radius will identify which of the eight radioisotopes produced it.

While we might expect all eight halos to be nested (have a common center) as shown above, G. H. Henderson made a surprising discovery⁶⁰ in 1939: **halos formed by the decay of three polonium isotopes (^{218}Po , ^{214}Po , and ^{210}Po) were often isolated, not nested.** Since then, the mystery has deepened, and possible explanations have generated heated controversy.

Thorium-232 (^{232}Th) and ^{235}U also occur naturally in rocks, and each begins a different decay series that produces different polonium isotopes. However, only the ^{238}U series produces isolated polonium halos. Why are isolated polonium halos in the ^{238}U decay series but not in other decay series? *If a supernova produced and scattered ^{235}U throughout our galaxy billions of years ago, and the Earth evolved millions of years later from some of that scattered debris, why is ^{235}U still around, since its 700-million-year half-life is relatively short? All that ^{235}U should have decayed and become lead. Where is all that lead? What concentrated ^{235}U in Earth's crust?*

Surprisingly, polonium radiohalos are often found without their parents—or any other prior generation! How could that be? Polonium is always a decay product. It must have had parents! Notice that ^{222}Rn is on the rung immediately above the three polonium isotopes, but the ^{222}Rn halo is missing. Because ^{222}Rn decays with a half-life of only 3.8 days, its halo should be found with the polonium halos. Or should it?

Dr. Robert V. Gentry, the world's leading researcher on radiohalos, has proposed the following explanation for this mystery.⁶² He correctly notes that halos cannot form in a liquid, so they could not have formed while the rock was solidifying from a molten state. Furthermore, any polonium in the molten rock would have decayed long before the liquid could cool enough to solidify. *Therefore, we can all see that those rocks did not cool and solidify over eons, as commonly taught!* However, Gentry believes, *incorrectly*, that on Day 1 of the creation, a billion or so polonium atoms were concentrated at each of many points in rock; then, within days, the polonium decayed and formed isolated (parentless) halos.

Gentry's explanation has five problems. First, it doesn't explain what concentrated a billion or so polonium atoms at each of trillions of points that later become the centers of parentless polonium halos. Second, to form a distinct ^{218}Po halo, those ^{218}Po atoms, must undergo heat-releasing alpha decays, half of which would occur within 3.1 minutes. The great heat generated in such a tiny volume in just 3.1 minutes would melt the entire halo. Not only did melting not occur, had the temperature of the halo ever exceeded 300°F (150°C) the alpha tracks would have been erased (annealed).⁶⁴ Obviously, an efficient heat removal mechanism, which will soon be explained, must have acted.

Third, polonium has 33 known radioisotopes, but only three (^{218}Po , ^{214}Po , and ^{210}Po) account for almost all the isolated polonium halos. Those three are produced only by the ^{238}U decay series, and ^{238}U deposits are often found near isolated polonium halos. Why would only those three isotopes be created instantly on Day 1? This seems unlikely. Instead, something produced by only the ^{238}U decay series accounts for the isolated polonium halos. As you will soon see, that “something” turns out to be ^{222}Rn .

Fourth, Henderson and Sparks, while doing their pioneering work on isolated polonium halos in 1939, made an important discovery: they found that the centers of those halos, at least those in the biotite “books” they examined, were usually concentrated in certain “sheets” inside the biotite.⁶⁵ (Biotite, like other micas, consists of thin “sheets” that children enjoy peeling off as if the layers were sheets in a book.)

In most cases, it appears that they [the centers of the isolated halos] are concentrated in planes parallel to the plane of cleavage. When a book of biotite is split into thin leaves, most of the latter will be blank until

*a certain depth is reached, when signs of halos become manifest. A number of halos will then be found in a central section in a single leaf, while the leaves on either side of it show off-centre sections of the same halos. The same mode of occurrence is often found at intervals within the book.*⁶⁶

Apparently, polonium atoms or their ^{222}Rn parent flowed along what is now the central sheet and lodged in the channel wall as that mineral sheet grew. In other words, the polonium was not created on Day 1 inside solid rock.

Fifth, isolated polonium halos are often found near uranium mines, where magma containing uranium was injected up through fossil-bearing strata. Therefore, the intrusions and polonium halos formed after the flood, which itself was *long after creation*. The magma slowly cooled and solidified, while the uranium began releasing ^{222}Rn that was quickly dissolved and transported upward in flowing water. The polonium daughters of ^{222}Rn produced the parentless polonium halos.

On 23 October 1987, after giving a lecture at Waterloo University near Toronto, Ontario, I was approached by amateur geologist J. Richard Wakefield, who offered to show me a similar intrusion. The site was near a uranium mine, about 150 miles to the northeast near Bancroft, Ontario, where Bob Gentry had obtained some samples of isolated polonium halos. I accepted and called my friend Bob Gentry to invite him to join us. Several days later, he flew in from Tennessee and, along with an impartial geologist who specialized in that region of Ontario, we went to the mine. Although we could not gain access into the mine, we all agreed that the intrusion cut up through the sedimentary layers.⁶⁷

Gentry concluded while we were there (and later wrote⁶⁸) that intrusions through sedimentary layers *were* created supernaturally and contained ^{218}Po , ^{214}Po , and ^{210}Po (but no other polonium isotopes). Then the ^{218}Po , ^{214}Po , and ^{210}Po decayed minutes or days later. Unfortunately, I had to disagree with my friend; the heat generated would have melted the entire halo.⁶⁵ Besides, those sedimentary layers were laid down during the flood, so the intrusions occurred after the flood—long after the creation, when Gentry claims they formed. [See “**Liquefaction: The Origin of Strata and Layered Fossils**” on pages 195–213.] Since 1987, isolated polonium halos have been reported in other flood deposits.⁶⁹

Dr. Lorence G. Collins has a different explanation for the polonium mystery. He first made several perceptive observations. The most important was that strange wormlike patterns were in “*all of the granites in which Gentry found polonium halos.*”⁷⁰ Those microscopic patterns, each about 1 millimeter long, resembled almost parallel “*underground ant tunnels*” and were typically filled with two minerals common in granite: quartz and plagioclase [PLA-jee-uh-clase] feldspars, specifically sodium feldspars.⁷¹ The granite had

not melted, nor had magma been present. The rock that contains these wormlike patterns is called *myrmekite* [MUR-muh-kite]. Myrmekites have intrigued geologists and mineralogists since 1875. Collins admits that he does not know why myrmekites and isolated polonium halos are found together in granites.⁷² You soon will.

Collins notes that those halos all seem to be near uranium deposits and tend to be in two minerals (biotite and fluorite) in granitic pegmatites [PEG-muh-tites] and in biotite in granite *when myrmekites are present*.⁷³ (Pegmatites will soon be described. Biotite, fluorite, and pegmatites *form out of hot water solutions in cracks in rocks.*) Collins also knows that radon (Rn) inside the Earth's crust is a gas; under such high pressures, it readily dissolves in hot water. Because radon is inert, it can move freely through solid cracks without combining chemically with minerals lining the walls of those cracks.

Collins correctly concludes that “voluminous” amounts of hot, ^{222}Rn -rich water must have surged up through sheared and fractured rocks.⁷⁴ When ^{222}Rn decayed, ^{218}Po formed. Collins insights end there, but they raise six questions.

- What was the source of all that hot, flowing water, and how could it flow so rapidly up through rock?⁷⁵
- Why was the water ^{222}Rn rich? ^{222}Rn has a half-life of only 3.8 days!
- Because halos are found in different geologic periods, did all this remarkable activity occur repeatedly, but at intervals of millions of years? If so, how?
- What concentrated a billion or so ^{218}Po atoms at each microscopic speck that became the center of an isolated polonium halo? Why wasn't the ^{218}Po dispersed?
- Today's extremely slow decay of ^{238}U (with a half-life of 4.5-billion years) means that its daughters, granddaughters, etc. today form slowly. Were these microscopic specks the favored resting places for ^{218}Po for billions of years, or did the decay rate of ^{238}U somehow spike just before all that hot water flowed? Remember, ^{218}Po decays today with a half-life of only 3.1 minutes.
- Why are isolated polonium halos associated with parallel and aligned myrmekite that resembles tiny ant tunnels?

Answers, based on the hydroplate theory, will soon be given.

Elliptical Halos. Robert Gentry made several major discoveries concerning radiohalos, such as elliptical halos in coalified wood from the Rocky Mountains. In one case, he found a spherical ^{210}Po halo superimposed on an elliptical ^{210}Po halo. Apparently, a spherical ^{210}Po halo was forming, but then was *suddenly* compressed by about 40% into an elliptical shape. Then, the partially depleted ^{210}Po (whose half-life is 138 days) finished its decay, forming the spherical halo.⁷⁶

Explosive Expansion. Mineralogists have found, at many places on Earth, radial stress fractures *surrounding* certain minerals that experienced extensive alpha decays. Halos

were not seen, because billions of decaying radioisotopes were not concentrated at microscopic points. However, alpha decays throughout those minerals destroyed their crystalline structure, causing them to expand by up to 17% in volume.⁷⁷

Dr. Paul A. Ramdohr, a famous German mineralogist, observed that these surrounding fractures did not occur, as one would expect, along grain boundaries or along planes of weakness. Instead, the fractures occurred in more random patterns around the expanded material. Ramdohr noted that if the expansion had been slow, only a few cracks—all along surfaces of weakness—would be seen. Because the cracks had many orientations, the expansion must have been “explosive.”⁷⁸ What caused this rapid expansion? [See Figure 208 and then read, “[When, Where, How, and Why Did Radioactive Decay Rates Accelerate?](#)” on page 398.]

Pegmatites. Pegmatites are rocks with large crystals, typically one inch to several feet in size. Pegmatites appear to have crystallized from hot, watery mixtures containing some chemical components of nearby granite. These mixtures penetrated large, open fractures in the granite where they slowly cooled and solidified. What Herculean force produced the fractures? Often, the granite is part of a huge block, with a top surface area of at least 100 square kilometers (40 square miles), called a **batolith**. Batholiths are typically granite regions that have pushed up into the overlying, layered sediments, somehow removing the layers they replaced. How was room made for the upthrust granite? Geologists call this “the room problem.”⁷⁹

This understanding of batholiths and pegmatites is based primarily on what is seen today. (In other words, we are trying to reason only from the *effect* we see *back to its cause*.) A clearer picture of how and when they formed—and what other major events were happening on Earth—will become apparent when we also reason in the opposite direction: from *cause to effect*. Predictions are also possible when one can reason from cause to effect. Generally, geology looks backward, and physics looks forward. We will do both and will not be satisfied until a detailed picture emerges that is consistent from both vantage points. This will help bring into sharp focus “the origin of Earth’s radioactivity.”

Theories for the Origin of Earth’s Radioactivity

The Hydroplate Theory. In the centuries before the flood, supercritical water (SCW) in the subterranean chamber steadily dissolved the more soluble minerals in the rock directly above and below the chamber. [Pages 126–127 explain SCW and its extreme dissolving ability.] Thin spongelike channels, filled with high-pressure SCW, steadily grew up into the increasingly porous chamber roof and down into the chamber floor.

The flood began when the granite crust ruptured, and subterranean water escaped violently upward through the

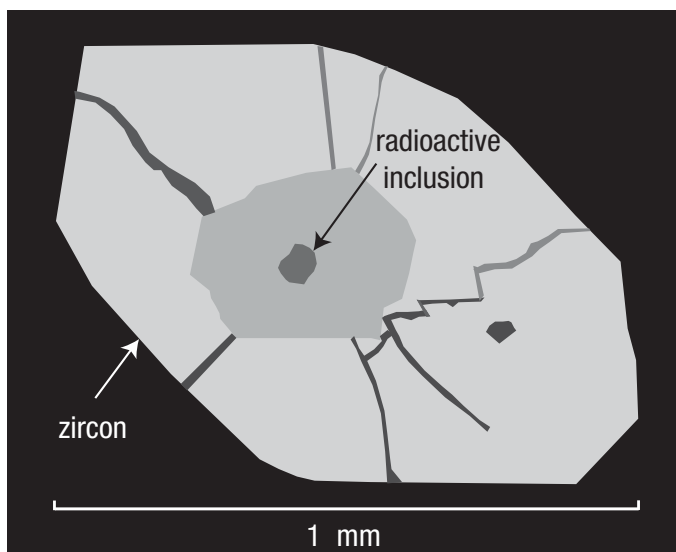

Figure 208: Radial Fractures. Alpha decays within this inclusion caused it to expand significantly, radially fracturing the surrounding zircon that was ten times the diameter of a human hair. These fractures were not along grain boundaries or other surfaces of weakness, as one would expect. Mineralogist Paul Ramdohr concluded that *the expansion was explosive*. To see why it was explosive, see “[When, Where, How, and Why Did Radioactive Decay Rates Accelerate?](#)” on page 398.

globe-encircling rupture. Pillars had to support more of the crust’s weight, because the subterranean water supported less. Tapering downward like icicles, the pillars crushed in stages, beginning at their tips. With each collapse and with each water-hammer cycle, the crust fluttered like a flag held horizontally in a strong wind. Each downward “flutter” rippled through the Earth’s crust and powerfully slammed what remained of pillars against the subterranean chamber floor. [See “[Water Hammers and Flutter Produced Gigantic Waves](#)” on page 197.]

For weeks, compression-tension cycles within both the fluttering crust and pounding pillars generated piezoelectric voltages that easily reached granite’s breakdown voltage.⁸¹ Therefore, powerful electrical currents discharged within the crust repeatedly, along complex paths of least electrical resistance. [See Figures 209–212.]

Electrons flowing through solids, liquids, or gases are decelerated and deflected by electrical charges in the atoms encountered. These decelerations, if energetic enough, release bremsstrahlung (BREM-stra-lung) radiation which vibrates other nuclei and releases some of their neutrons.

*Neutrons will be produced in any material struck by the electron beam or bremsstrahlung beam above threshold energies that vary from 10–19 MeV for light nuclei and 4–6 MeV for heavy nuclei.*⁸²

At electrical breakdown, the energies in the surging electrons were thousands of times greater than 10–19 MeV, so during the flood, bremsstrahlung radiation released a sea of neutrons throughout the crust.⁸³

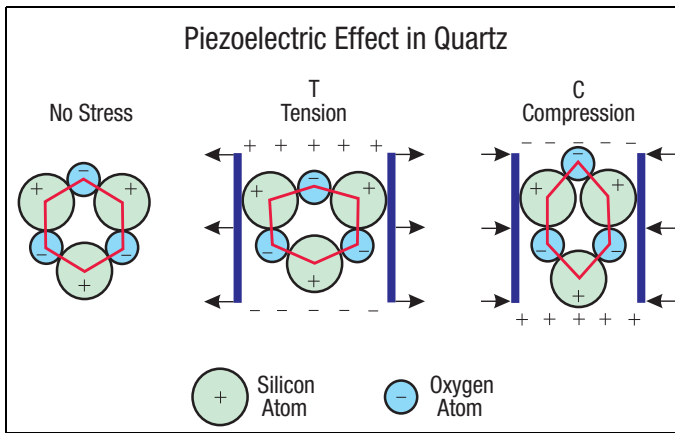

Figure 209: Piezoelectric Effect. *Piezo* [pea-A-zo] is derived from the Greek “to squeeze” or “to press.” Piezoelectricity is sometimes called *pressure electricity*. When a nonsymmetric, nonconducting crystal, such as quartz (whose structure is shown above in simplified form), is stretched, a small voltage is generated between opposite faces of the crystal. When the tension (T) changes to compression (C), the voltage changes sign. As the temperature of quartz rises, it deforms more easily, producing a stronger piezoelectric effect. However, *once the temperature reaches about 1,063°F (573°C), the piezoelectric effect disappears.*⁸⁰

Quartz, a common mineral in the Earth’s crust, is piezoelectric. (Granite contains about 27% quartz by volume.) Most nonconducting minerals are symmetric, but if they contain defects, they are to some degree nonsymmetric and therefore are also piezoelectric. If the myriad of piezoelectric crystals throughout the 60-mile-thick granite crust were partially aligned and cyclically and powerfully stretched and compressed, huge voltages and electric fields would rapidly build up and collapse with each flutter half-cycle. If those fields reached about 9×10^6 volts per meter, electrical resistances within the granite would break down, producing sudden discharges—electrical surges (a plasma) similar to lightning. [See Figures 202 and 211.] Even during some large earthquakes today, this piezoelectric effect in granite generates powerful electrical activity and hundreds of millions of volts.⁴ [See “**Earthquakes and Electricity**” on page 387.]

Granite pillars, explained on page 469 and in Figure 55 on page 124, were formed in the subterranean water, in part, by an extrusion process. Therefore, piezoelectric crystals in the pillars would have had a preferred orientation. Also, before the flood, tidal pumping in the subterranean water compressed and stretched the pillars and crust twice a day. Centuries of this “kneading action” plus “voltage cycling”—twice a day—aligned these crystals even more (a process called *poling*), just as adjacent bar magnets become aligned when cyclically magnetized. [See Figure 212.] Each piezoelectric crystal acts like a tiny battery—one among trillions upon trillions. So, as the flood began, the piezoelectric effect within pounding pillars and fluttering granite hydroplates generated immense voltages and electric fields. Each quartz crystal’s effective electrical field was multiplied by about 7.4 by the reinforcing electrical field’s of the myriad of nearby quartz crystals.⁸¹

Subterranean water absorbed many of these neutrons, converting normal hydrogen (^1H) into heavy hydrogen (^2H , called *deuterium*) and normal oxygen (^{16}O) into ^{18}O . Abundant surface water (a huge absorber) protected life.

During the flood, much of this ^2H - and ^{18}O -rich subterranean water was swept to the surface where it mixed with surface waters. Some subterranean water was

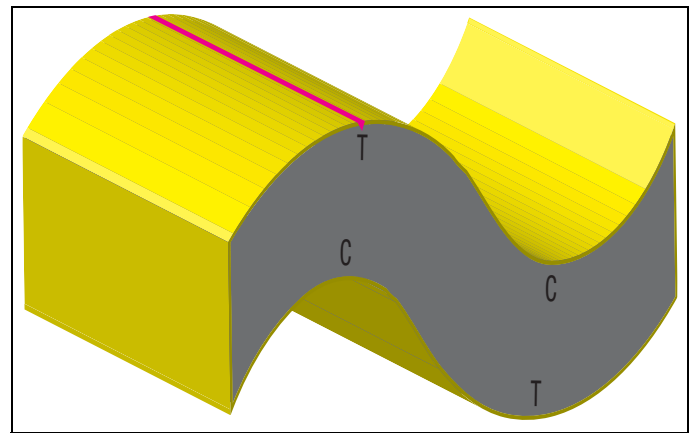

Figure 210: Fluttering Crust. Many of us have seen films showing Earth’s undulating crust during earthquakes. Imagine how magnified those waves would become if the crust, instead of resting on solid rock, were resting on a thick layer of unusually compressible water—SCW. Then, imagine how high those waves in the Earth’s crust would become if the “ocean” of water below the crust were flowing horizontally with great force and momentum. The crust’s vast area—the surface of the Earth (200,000,000 square miles)—gave the relatively thin crust great flexibility during the first few weeks of the flood. As the subterranean waters escaped, the crust flapped, like a large flag held horizontally in a strong wind.

Flutter began as the fountains of the great deep erupted. [See “**Water Hammers and Flutter Produced Gigantic Waves**” on page 197.] Each time the crust arched downward into the escaping subterranean water, the powerful horizontal flow slammed into the dipping portion of the crust, creating a water hammer that then lifted that part of the crust. Waves rippled through the entire crust at the natural frequencies of the crust, multiplying and reinforcing waves and increasing their amplitudes.

Grab a phone book firmly with both hands and arch it upward. The top cover is in tension, and the bottom cover is in compression. Similarly, rock in the fluttering crust, shown above, would alternate between tension (T) and compression (C). As explained in Figure 209, huge cyclic voltages would build up and suddenly discharge within the granite crust, because granite contains so much quartz, a piezoelectric mineral. Once granite’s breakdown voltage was reached, electrical current—similar to bolts of lightning—would discharge vertically within the crust. Pillars (not shown) at the base of the crust would become giant electrodes. With each cycle of the fluttering crust, current surged through the lower crust, which was honeycombed with tiny pockets of salty (electrically conducting) subterranean water.

temporarily trapped within all the mushy mineral deposits, such as salt (NaCl), that had precipitated out of the SCW and collected on the chamber floor years before the flood. Today, those mineral deposits are rich in ^2H and ^{18}O .⁸⁴

The Ukrainian experiments described on page 384 show that a high-energy, Z-pinch beam of electrons inside a solid produces superheavy elements that quickly fission into different elements that are typical of those in Earth’s crust. Fusion and fission occur simultaneously, each contributing to the other—and to rapid decay. While we cannot be certain what happens inside nuclei under the extreme and unusual conditions of these experiments, or

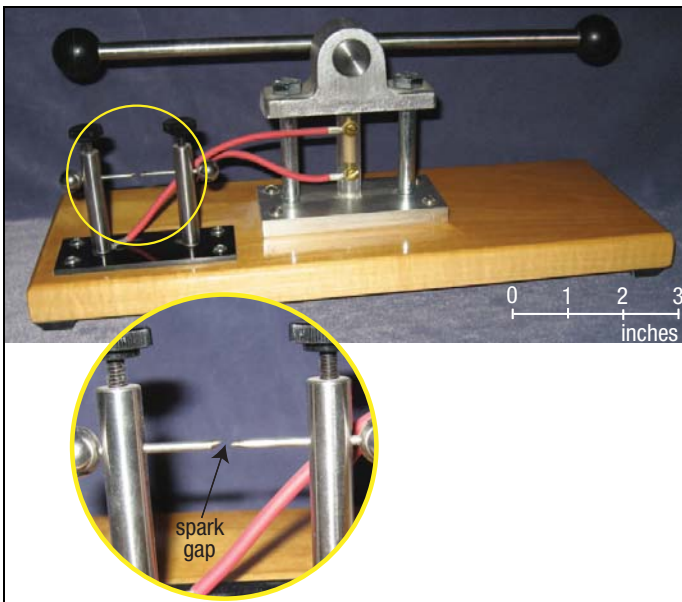

Figure 211: Piezoelectric Demonstration. When I rotate the horizontal bar of this device, a tiny piezoelectric crystal (quartz) is compressed in the vertical column just below the bar's pivot point. The red cables apply the generated voltage across the two vertical posts mounted on the black, nonconducting platform. Once the increasing voltage reaches about 4,000 volts, a spark (a plasma) jumps the gap shown in the circular inset. When the horizontal bar is rotated in the opposite direction, the stress on the quartz crystal reverses, so a spark jumps in the opposite direction.

In this device, a tiny quartz crystal and a trivial amount of compression produce 4,000 volts and a small spark. Now consider trillions of times greater compression acting on a myriad of quartz crystals filling 27% of a 60-mile-thick crustal layer. (An "ocean" of subterranean water escaping from below that crust created water hammers, causing the crust to flutter and produce enormous compressive stresses in the crust.) The resulting gigavoltages would produce frightening electrical discharges, not through air, but through rock—and not across a little gap, but **throughout the entire crust**.

what happened in the Earth's crust during the flood, here are three possibilities:

- a. **Electron Capture.** Electrons that enter nuclei convert some protons to neutrons—a common event called *electron capture*.

Also, the dense sea of electrons reduces the mutual repulsion (Coulomb force) between the positively charged nuclei, sometimes bringing them close enough for the strong force to pull them together. Fusion results. Even superheavy nuclei form.

- b. **Shock Collapse.**⁸⁶ Electrical discharges through the crust vaporize rock along very thin, branching paths "drilled" by gigavolts of electricity through extremely compressed rock. Rock along those paths instantly becomes a high-pressure plasma inside thin rock channels. The shock wave generated by the electrical heating suddenly expands the plasma and the surrounding channel walls, just as a bolt of lightning expands the surrounding air and produces a clap of

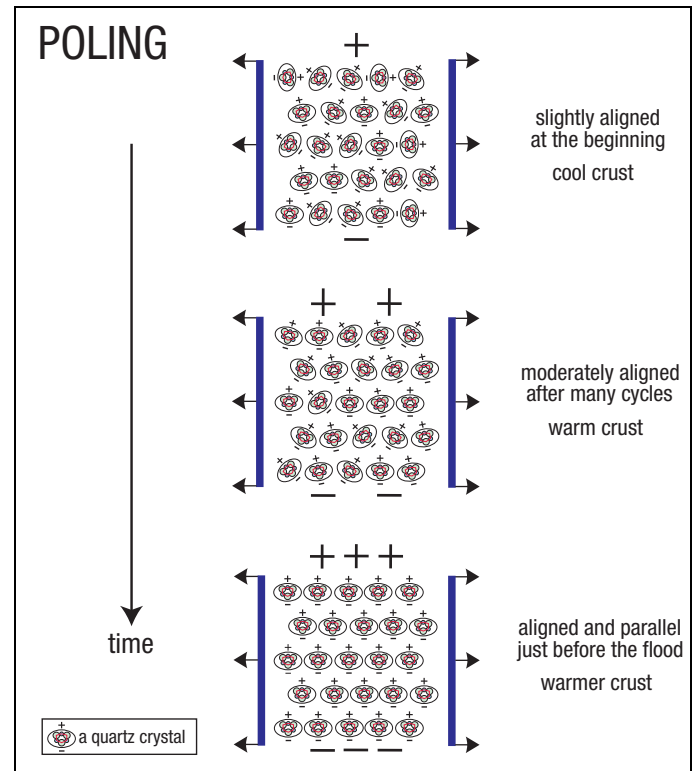

Figure 212: Poling. Poling is an industrial process that steadily aligns piezoelectric crystals so greater voltages can be produced. During the centuries before the flood, tidal stress cycles in the granite crust (tension followed by compression, *twice a day*)—and the electrical fields produced—applied a torque that slowly aligned the quartz crystals. (A similar picture, but with arrows and positive and negative signs reversed, could be drawn for the compression half of the cycle.) Over the years, stresses heated the crust to some degree, which accelerated the alignment process. Because so much electrical activity accompanies today's large earthquakes, we can see that pre-flood poling was effective. Laboratory tests have also shown that quartz crystals still have a degree of alignment in most quartz-rich rocks.⁸⁵

thunder. As that rock rebounds inward—like a giant, compressed spring that is suddenly released—the rock collapses with enough shock energy to drive (or fuse) nuclei together at various places along the plasma paths. This frequently happens deep in the crust where the rock is already highly compressed.

Superheavy elements quickly form, fission, and decay into such elements as uranium and lead. The heat released propels the plasma and new isotopes along the channels. As the channels contract, flow velocities increase. The charged particles and new elements are transported to sites where minerals are grown, one atom at a time.

- c. **Z-Pinch.** As explained on page 378 and in , the path of each electrical charge in a plasma is like a "wire." All "wires" in a channel are pinched together, but at each instant, pinching forces act only at the points occupied by moving charges, and each force is the sum of the electromagnetic forces produced by all nearby moving charges. Therefore, the closer the

Self-Focusing Z-Pinch



Figure 213: Z-Pinch Discovered. In 1905, lightning struck and radially collapsed part of a hollow, copper lightning rod (shown in this drawing⁸⁷). Professors J. A. Pollock and S. H. E. Barraclough at the University of Sydney then showed that a strong pinching effect occurs when powerful electrical currents travel along close, parallel paths.

Later, Willard H. Bennett provided a more rigorous analysis.⁸⁸ The closer the paths, the stronger the pinch—and when the flows are through a plasma, the stronger the pinch, the closer the paths. **The flows self-focus.**

Patents have since been granted for using the Z-pinch to squeeze atomic nuclei together in fusion reactors.

In a plasma flow, trillions upon trillions of electrical charges flow along close, parallel paths—positive charges in one direction and negative charges (electrons) in the opposite direction. The mutual repulsion of like charges doesn't widen the paths, because the opposite charges—although moving in the opposite direction—are in the same paths. In fact, the magnetic field created by all moving charges continually squeeze (or **Z-pinch**) all charged particles toward the central axis. During the flood, gigantic piezoelectric voltages produced electrical breakdown in the fluttering granite crust, so *each flow channel self-focused onto its axis.*

In that flow, nuclei, stripped of some electrons, were drawn closer and closer together by the Z-pinch. (Normally, their Coulomb forces would repel each other, but the electrons flowing in the opposite directions tended to neutralize those repulsive forces.) Nuclei that collided or nearly collided were then pulled together by the extremely powerful **strong force**. **Fusion occurred**, and even **superheavy elements formed**. Thousands of experiments at the Proton-21 Laboratory have demonstrated this phenomenon. Because superheavy elements are so unstable, they quickly fission (split) or decay.

Although fusion of nuclei lighter than iron released large amounts of nuclear energy (heat), the fusion of nuclei heavier than iron absorbed most of that heat and heat released by fission and decay. This also produced heavy elements that were not on Earth before the flood (*elements heavier than lead, such as bismuth, polonium, radon, radium, thorium, and uranium*). The greater the heat, the more heavy elements formed and absorbed that heat. A heavy flux of neutrons accompanied this production, so nuclei absorbed enough neutrons to make them nearly stable. This is why the ratios of the various isotopes of a particular element are generally fixed. These fixed ratios are seen throughout the Earth, because the flood and flux of neutrons were global.

“wires,” the greater the self-focusing, pinching force, so the “wires” become even closer, until the strong force merges (fuses) nuclei.

All three mechanisms are probably at work, although *c* is experimentally demonstrated by the 21 billion dollar TOKAMAK (a Russian acronym) jointly developed by the United States, France, Korea, Russia, the European Union, Japan, India, and China.

For centuries before the flood, SCW dissolved the more soluble minerals in the chamber's ceiling and floor. The resulting spongelike openings then filled with SCW. During the flood, that pore water provided an enormous surface area for slowing and capturing neutrons and other subatomic particles. Great heat resulted, some becoming Earth's geothermal heat. Simultaneously, electrical discharges “drilled” thin plasma channels within the crust, producing other nuclear reactions and additional heat.

For weeks, all this heat expanded and further pressurized the SCW in the spongelike channels in the lower crust, slowly forcing that water back into the subterranean chamber. Therefore, higher than normal pressures in the subterranean chamber continuously accelerated the escaping subterranean water, much like a water gun. [See Figure 216.] Velocities in the expanding fountains of the great deep reached at least 32 miles per second, thereby launching the material that became comets, asteroids, meteoroids, and TNOs! [See page 317.]

Heat added to SCW raises temperatures only slightly, for three reasons.

1. Liquid quickly evaporates from the surface of the myriad of microscopic droplets floating in the supercritical vapor. We see surface evaporation on a large scale when heat is added to a pan of water simmering on the stove at 212°F (100°C). The water's temperature does not rise, but great volumes of vapor are produced.
2. As heat was steadily added, positive and negative electrical charges (ions) were increasingly produced and separated. Therefore, more and more energy was stored electrically, so temperatures rose very little. As water escaped upward during the flood and temperatures and pressures dropped, those electrical charges recombined and the energy was recovered with almost 100% efficiency.
3. As more heat was added to the escaping SCW, the fountains accelerated even more. With that greater acceleration came greater *expansion and cooling*.

Nuclear energy primarily became electrical energy and then kinetic energy. Had the nuclear energy produced heat only, much of the Earth would have melted.⁸⁹ Also remember, quartz piezoelectricity shuts off at about 1,063°F (573°C).

Chemical Evolution Theory. The current evolutionary theory for the formation of chemical elements and radioisotopes evolved from earlier theories. Each began by assuming a big bang and considering what it might produce. Years later, fatal flaws were found.

Vast Energy Generated / Vast Energy Removed

Part of the nuclear energy absorbed by the subterranean water can be calculated. It was truly gigantic, amounting to a *directed* energy release of **1,800 trillion 1-megaton hydrogen bombs!**⁸⁹ Fortunately, that energy was produced over weeks, throughout the entire preflood Earth's 60-mile-thick (12-billion-cubic-mile) crust. The steady removal of that energy was equally impressive and gives us a vivid picture of the power of the fountains of the great deep and the forces that launched meteoroids and the material that later merged in outer space to become comets, asteroids, and TNOs.

Although our minds can barely grasp these magnitudes, we all know about the sudden power of hydrogen bombs. However, if that energy is generated over weeks, few know how it can be removed in weeks. That will now be explained.

Heat Removed by Water. Flow surface boiling removes vast amounts of heat, especially under high pressures. At MIT, I conducted extensive experiments that removed more heat, per unit area, than is coming off the Sun, per unit area, in the same time period. This was done without melting the metal within which that heat was electrically generated. [See Walter T. Brown, Jr., "A Study of Flow Surface Boiling," Ph.D. thesis, Massachusetts Institute of Technology, 1967.]

During flow-surface boiling or boiling in a pan of water on your stove, bubbles erupt from microscopic pockets of vapor trapped between the liquid and cracks and valleys (pits) in the surface of hot solids, such as rocks, metals, or a pan on your stove. If the liquid's temperature is above the so-called boiling point,⁹⁰ liquid molecules will jump into the vapor pockets, causing them to "balloon up" in milliseconds to the size of visible bubbles. The flowing liquid strips the growing bubbles from the solid. Sucked behind each bubble is hot liquid that was next to the hot solid. Relatively cold liquid then circulates down and cools the hot solid. (If you could submerge a balloon deep in a swimming pool and jerk the balloon several balloon diameters *in a few milliseconds*, you would see a similar powerful flow throughout the pool.)

Once the bubble is ripped away from the solid, liquid rushes in and tries to fill the pit from which the bubble grew a millisecond earlier. Almost never can the pit be completely filled, so another microscopic vapor pocket, called a *nucleation site*, is born, ready to grow another bubble.

Jetting. As bubbles quickly grow from the hot solid's surface into the relatively cool liquid, a second effect—jetting (or *thermocapillarity*)—removes even more heat from the hot surface. The surface tension in the thin film of liquid surrounding the growing bubble acts like the skin of a balloon. That surface tension is much stronger in the colder portion of the bubble than the hotter portion next to the hot solid. Therefore, the bubble's skin

circulates, dragging hot liquid next to the boiling surface up to and beyond the cold top of the bubble, far from the hot solid. With proper lighting, the hot liquid next to the solid can be seen jetting into the colder flowing liquid. [See Figure 214.] Vast amounts of heat are removed as hundreds of bubbles per square inch shoot jets of hot liquid away from the solid surface being cooled.



Figure 214: Thermocapillarity. Boiling removes heat from a hot solid by several powerful mechanisms. In one process, the surface tension surrounding a growing bubble propels the hot liquid away from the hot solid, so cooler liquid can circulate in and cool the solid. If cooler liquid is also flowing parallel to and beyond the hot, thermal boundary layer next to the solid, as it would have been with water flowing in vertical channels throughout the crust during and shortly after the flood, the tops of the growing bubbles would have been even cooler. Therefore, the surface tension at the tops of the bubbles would have been stronger yet, so heat removal by jetting would have been even more powerful.

Burnout. A dangerous situation, called *burnout*, arises if the bubble density becomes so great that vapor (an effective insulator) momentarily blankets the hot solid, preventing most of the generated heat from escaping into the cooler liquid. The solid's temperature suddenly rises, melting the solid. With my high-pressure test apparatus at MIT, a small explosion would occur with hot liquid squirting out violently. Fortunately, I was behind a protective wall. Although it took days of work to clean up the mess and rebuild my test equipment, that was progress, because I then knew one more of the many temperature-pressure-velocity combinations that would cause burnout for *each liquid-solid combination*.

During the flood, subsurface water removed even more heat, because the fluid was supercritical water (SCW). [See "SCW" on page 126.] Vapor blankets could not develop because SCW, *which is a mixture of microscopic liquid droplets floating in a very dense vapor, cannot boil!* The liquid droplets, rapidly bouncing off the solid, remove heat without raising the temperature too much. The heat energy gained by SCW simply increases the pressure, velocity, and number of droplets, all of which then increases the heat removal.⁹¹ Significantly, the hotter the SCW becomes,

the more the water molecules break into ions (H^+ and OH^-), so thermal energy becomes colder electrical energy. When the flood began, and for weeks afterward, almost all that energy became kinetic, as explained in Figure 216. The fountains of the great deep reached speeds of 32 miles per second!

To appreciate the large velocities in the fountains, we must understand the speeds achievable if large forces can steadily accelerate material over long distances. As a boy, my friends and I would buy bags of dried peas and put a dozen or so in our mouths for our pea-shooting battles. We would place one end of a plastic straw in our mouths, insert a pea in the straw with our tongues, and sneak around houses where we would blow peas out the straws and zap each other. (Fortunately, no one lost his eyesight.) With a longer straw and a bigger breath, I could have shot faster and farther. Cannons, guns, rifles, mortars, and howitzers use the same principle. [See Figure 215.]

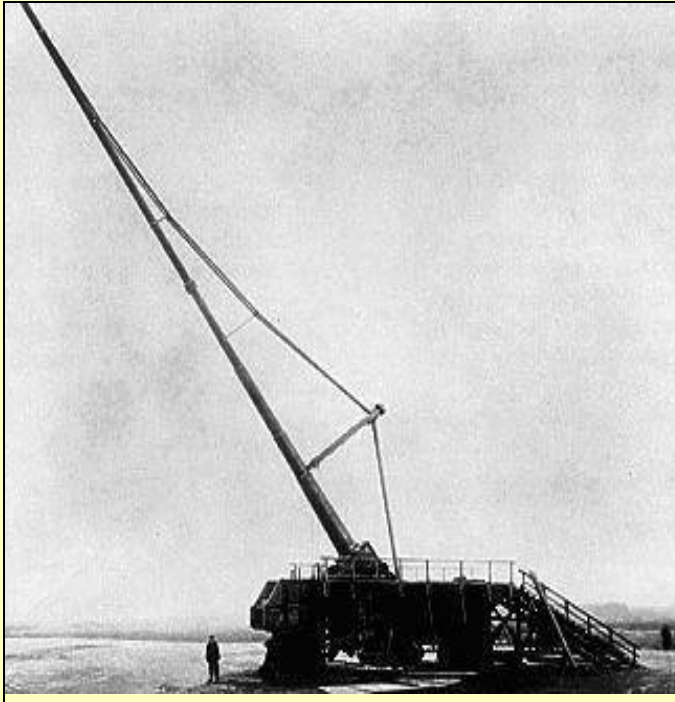

Figure 215: Paris Gun. German engineers in World War I recognized that longer gun tubes would, with enough propellant (energy), accelerate artillery rounds for a longer duration, fire them faster and farther, and even strike Paris from Germany. In 1918, this 92-foot-long gun, launching 210-pound rounds *at a mile per second*, could hit a target 81 miles away in 3 minutes. The people living in Paris thought they were being bombed by quiet, high-altitude zeppelins (dirigibles).

If a 92-foot-long gun could launch material at a mile per second, how fast might a 60-mile-long gun tube launch material? How much kinetic energy might the subterranean water gain by using nuclear energy to steadily accelerate the water horizontally under a hydroplate for hundreds (or thousands) of miles before reaching the base of the rupture? There, the water would collide with the oncoming flow, mightily compress, and then elastically rebound upward—the only direction of escape—accelerating straight up at astounding speeds. In principle, if a gun tube (or flow channel) is long enough and enough energy is available, a projectile could escape Earth's gravity and enter cometlike orbits. Nuclear reactions provided more than enough energy to launch water and rocks into space.



Figure 216: Water Gun. My granddaughter, Laney, demonstrates, in a simplified way, how, during the early weeks of the flood, vast amounts of nuclear energy steadily accelerated all the fountains of the great deep, and launched 10^{21} metric tons of rocks (a thousand, million gigatons of rocks) into outer space. Laney adds energy by pushing on the plunger. The pressure does not build up excessively and rupture the tube; instead, the steady pressure continuously accelerates a jet of water—a fountain. Sometimes the jet hits her poor grandfather.

For weeks after the flood began, each incremental release of nuclear energy in the fluttering crust increased the SCW's pressure within the interconnected pore spaces in the lower crust. But that pressure increase was transferred through those spongelike channels in the lower crust down into the subterranean water chamber, so the increased pressure continuously accelerated the water flowing out from under each hydroplate. Therefore, the velocities of the fountains became gigantic while the pressures in the channels did not grow excessively and destroy even more of the crust.⁹² While Earth's crust acquired its extreme geothermal heat, **the energy in the expanding fountains was almost entirely kinetic, not heat.** To appreciate how cold the fountains became, see "Rocket Science" on page 581.] That kinetic energy expelled water and rocky debris even into outer space.

Of course, Laney's gun is small in diameter, so the walls of the tube and nozzle produce considerable friction. However, if the water gun became large enough to hold and expel an "ocean of water," the friction per unit of water would be negligible. Also, if Laney could push the plunger hard enough to accelerate that much water, not for inches and 1 second, but for 60 miles and for weeks, and if the pressure she applied to the plunger exceeded the gigantic pre-flood pressure in the subterranean chamber, she too could expel gigatons of water and large rocks into outer space.

Although the atmospheric turbulence would have been terrifying, would the fountains have overheated the atmosphere? No. Nor would an extremely hot bullet fired through a wall set the wall on fire—and the fountains were much faster than a bullet. Also, recognize how cold the fountains became. [Again, see "Rocket Science."] The rupture—a 60-mile-deep tension fracture—suddenly became miles wide⁹³ and then grew hundreds of miles wide from erosion and crumbling. (Tension cracks suddenly pull apart, just as when a stretched rubber band snaps, its two ends rapidly separate.) Therefore, once the fountains broke through the atmosphere, only the sides of the fountains—a relatively thin boundary layer—made contact with and were slowed by the atmosphere. Besides, the fountains pulsed at the same frequency as the fluttering crust—about a cycle every 30 minutes.⁹⁴ These quick pulsations would not overcome much of the atmosphere's great inertia, so little atmosphere was dragged upward into outer space. (To demonstrate this property of inertia, which even gases have, give a quick horizontal jerk on a tablecloth and notice how plates on the tablecloth remain motionless.) Yes, Laney's gun is orders of magnitude smaller than the fountains of the great deep, but the mechanism, forces, and energy are analogous.

Oil—and Mountains of Salt—All in the Right Places

In the centuries before the flood, the supercritical water (SCW) in the subterranean chamber dissolved certain minerals in the granite crust, such as quartz. Quartz occupies 27% of granite by volume, so the lower several miles of the crust became quite porous.⁹⁵ Because that dissolving occurred from the subterranean chamber up into the chamber's ceiling, continuous channels, all filled with SCW, occupied every sponge-like pore space in the lower crust down to the subterranean chamber.

When the flood began, the fluttering crust produced piezoelectric surges that generated nuclear energy—an amount equivalent to about **1,800 trillion 1-megaton hydrogen bombs!**⁸⁹ Fortunately, that energy was not released in an explosion at a specific point on Earth. Instead, it was generated gradually and dissipated as heat over many weeks throughout the 12-billion-cubic-mile granite crust.

Water is usually the preferred heat absorber in today's nuclear reactors, because water readily absorbs the kinetic energy of the multitude of fast neutrons produced in nuclear reactions. Therefore, heating of the SCW in each channel steadily built up astounding pressures down in the subterranean water chamber. That pressure accelerated, at hypersonic velocities, all the fountains of the great deep out of the globe-encircling rupture. *Were the portions of the 60-mile-thick granite crust far from the pressure-relieving rupture able to contain those internal pressures?*

You will recall the description (on page 121 and Endnote 30 on page 142) of mountains of salt—some taller than Mount Everest! They rise from the 1,000-foot-thick mother salt layer that lies up to 30,000 feet below the floor of the Gulf of Mexico. An even thicker mother salt layer is under the Mediterranean Sea. Page 126 explained how tidal pumping, centuries before the flood, steadily increased temperatures in the subterranean water. When temperatures reached about 840°F (450°C), sodium (Na) and Chlorine (Cl), dissolved in the SCW, precipitated and formed a thick, mushy layer of salt (NaCl) on the chamber floor. (This phenomenon, discovered in 1879 and explained on pages 126–127, is called *out-salting*.)

As a result of the extreme pulsating pressures in the subterranean chamber, the chamber's ceiling was blown off in *at least* two places, forming today's Gulf of Mexico and Mediterranean Sea. The subterranean water that escaped up through those large openings left by the bursting crust swept wet salt lying along the subterranean chamber floor toward the base of those holes, onto what are now the floors of the Gulf of Mexico and Mediterranean Sea.

(Dry salt resists movement about as much as sand or dirt, but wet salt flows as smoothly as warm putty. You can demonstrate this by pouring a tablespoon of salt into the palm of your hand. Then, with a finger on your other hand, feel how friction resists

movement in dry salt. Now place a few drops of water onto that salt and feel how slippery and fluid-like the salt becomes.)

Over time, thousands of feet of dense sediments were then deposited on top of the less-dense, mushy mother salt layers—an *unstable condition*.⁹⁶ Those sediments came from the debris blasted from the holes themselves, sediments from the flood, and centuries of river sediments flowing into the Gulf and Mediterranean. Mother salt layers flow smoothly, so slight disturbances cause the less dense salt to flow up through the denser sediments. This produces salt domes, as explained on page 121 and in Figure 62 on page 129. Those rising domes grew by salt from the mother salt layer that flowed laterally into the domes' bases from adjacent areas. That removal of salt left the depressions (pockmarks) seen in Figure 217.

The Salt-Oil Connection. Geophysicists exploring for oil know that large oil fields are often near massive salt deposits.⁹⁷ The hydroplate theory explains this. But first, consider two recent examples of the many unbelievably large salt deposits next to vast oil fields.

- ◆ Beneath the floor of the Gulf of Mexico are huge oil reserves. Most people will recall the 2010 Deepwater Horizon oil spill in the Gulf of Mexico. It was the largest marine oil spill in recorded history. Drilling has confirmed the immense salt deposits under that floor.
 - ◆ In 2006, Brazil discovered, off its Atlantic coast, the largest oil field found in the western hemisphere in the last 30 years—the Tupi oil field. It lies first under 7,060 feet of water, then under 10,000 feet of sand and rocks, and finally under 6,600 feet of salt—a total of 4.8 miles below the surface of the Atlantic Ocean.
- How did all that oil get under such a deep, thick salt layer?**

Hydroplate Explanation. During the early stages of the flood, some sediments loaded with organic material (especially forests ripped up by the flood waters) were swept off the edge of the hydroplates and onto the exposed chamber floor. It, like the chamber's ceiling, had also been made porous by and filled with SCW. Figure 56 on page 125 gives clear evidence (1) of this porosity, (2) that the flood was recent, and (3) that the ocean floors are young.

As the hydroplates settled onto the chamber floor, the scouring ability of the escaping subterranean water increased greatly,⁹⁸ so large amounts of the precipitated salt were swept out of the chamber and on top of the organic material deposited weeks earlier. Since then, SCW, escaping up from the former chamber floor, has dissolved the organic material, forming various hydrocarbons. We see SCW doing this today on the sea floor.⁹⁹ Because oil is too viscous to penetrate layers of wet salt, the oil deposits have been trapped for thousands of years.

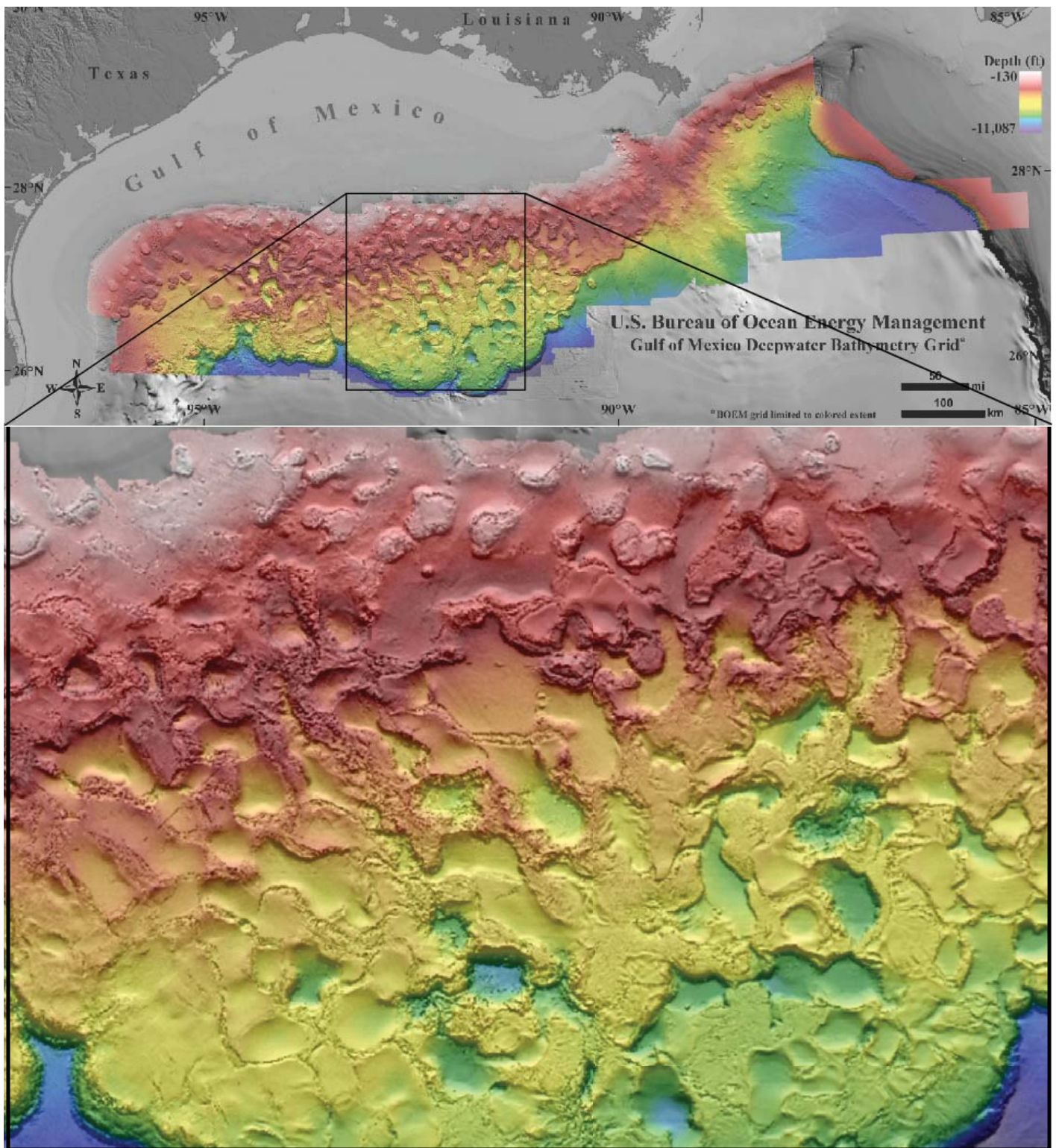

Figure 217: Gulf of Mexico. The 135-mile-wide square in the top map is expanded in the bottom map to show a detailed three-dimensional view of the pockmarked floor in the Gulf of Mexico. Each pixel covers an area on the sea floor the size of a typical home. Because the mushy, mother salt layer is so fluid, it eventually pooled at the lowest possible depths. Early during the flood, the pulsating, high-pressure subterranean water broke through the granite crust. Sediments almost 30,000 feet thick were then deposited on top of the 1,000-foot-thick mother salt layer. Weight imbalances forced the more buoyant salt to rise through the denser (still mushy) sediments as salt domes—mountains of salt, some taller than Mount Everest. Depressions formed in other places as the salt that was directly below the pockmarks flowed laterally and fed into the bases of nearby, rising salt domes. Huge salt deposits also underlie the Mediterranean seafloor.

If you look at a globe, doesn't it appear that a circular region of the Americas' hydroplate was blown out to form the Gulf of Mexico and part of the Europe/Africa/Asia hydroplate was blown out to form the Mediterranean Sea? What about the Black Sea, the Arctic Ocean, and the Caribbean?

When, Where, How, and Why Did Radioactive Decay Rates Accelerate?

Creationists, who believe the Earth is young, must explain why we see so many radioactive decay products if the Earth is not billions of years old. A few creationists, without understanding how Earth's radioactivity began, say that radioactive decay rates must have *miraculously* accelerated at some unknown time in the past to produce all those decay products. But that would have generated enough heat to boil all the oceans away, so they say that another miracle must have removed all that heat. While I agree that the Earth is young, miracles should not be imagined to solve scientific problems. That would violate the most basic rule of science. For details, see Figure 255 on page 559 and Endnote 11 on page 563.

Based on the considerable observable evidence already presented, here is a synopsis of what happened. At the beginning of the flood, piezoelectric surges Z-pinned (fused) various stable nuclei along the surge paths into unstable proton-heavy and superheavy nuclei, some of which rapidly fissioned and decayed. Months later, the compression event (which, as explained on page 486, lasted less than 1 hour) suddenly generated even more powerful piezoelectric surges which caused accelerated radioactive decay. Why did accelerated decay happen?

Photo-Fission. All nuclei continually vibrate,¹⁰⁰ similar to a drop of water we might imagine “floating” inside a spacecraft. The quivering nucleus has at least six vibrational patterns, called *modes*. Each mode has many resonant (or natural) frequencies. Radioactive nuclei made during the early weeks of the flood were always on the verge of decaying (or even flying apart), especially in response to external electrical disturbances. (We have already shown on page 382 specific situations in which the demonstrated electrical mechanisms of Fritz Bosch¹⁸ and William Barker²¹ suddenly sped up radioactive decay a billion fold.) Surging electrical currents during the compression event at the end of the flood provided great disturbances by emitting *bremstrahlung radiation*. (Recall from page 390 that electrons, surging through solids, liquids or gases, decelerate, lose kinetic energy, but conserve energy by emitting *bremstrahlung radiation*.)

As an example of one mode (the *Giant Dipole Vibration Mode*), known since the late 1940s,¹⁰⁰ consider a

high-energy (5×10^{21} cycles per second) electromagnetic wave (created by *bremstrahlung radiation*) passing by an almost unstable (radioactive) nucleus.

The protons in the nucleus are accelerated [back and forth] by the [cyclic bremstrahlung] electrical field. The neutrons [having no electrical charge] are unaffected by the field, but they move in the direction opposite to that of the protons so that the center of mass of the nucleus remains stationary and momentum is conserved. The restoring force, which ultimately reverses the motions of the protons and neutrons, is the strong nuclear force responsible for binding them together.¹⁰¹

Bremstrahlung radiation is released one photon at a time. The first photons emitted are the most energetic and radiate at the highest frequency. Subsequent photons have lower energies and frequencies—from gamma rays and x-rays down to radio waves. The closer these frequencies are to any resonant frequency of nearby radioactive nuclei, the larger the vibrational amplitudes produced in those nuclei. If the trillions upon trillions of electrons in each surge add enough energy to these almost unstable nuclei, **radioactive decay accelerates.**¹⁰² One demonstration of this is shown in Figure 208 on page 390.

Large *stable* nuclei were also made radioactive by powerful *bremstrahlung radiation*. The vibrations that are set up temporarily distort a nucleus and, as explained on page 390, can cause it to eject one or more neutrons.⁸³ The nucleus then becomes proton heavy which makes it less stable and more likely to decay. Other nuclei that absorb these ejected neutrons also become less stable.

As the Proton 21 Laboratory has demonstrated, in what is called “*cold repacking*,” most of the heat produced was absorbed in producing heavy elements, such as uranium. [See page 384.] Therefore, accelerated decay did not overheat the Earth or evaporate all our oceans. A miracle is not needed and, of course, should never be claimed to solve a scientific problem. Anyone who wishes to dispute the Proton 21 Laboratory's evidence should first read *Controlled Nucleosynthesis*³¹ and then explain the thousands of ruptured electrodes, one of which is shown in Figure 206 on page 384. Better yet, borrow one of that laboratory's thousands of accumulating screens and, using a mass spectrometer, examine its captured decay fragments and new

Initially (in 1946), George Gamow, a key figure in developing the big bang theory, said that during the first few seconds after the universe's hot expansion began, nuclear reactions produced all the chemical elements.¹⁰³ Two years later, Gamow retracted that explanation. Few heavy elements could have been produced, because the expansion rate was too great, and the heavier the nuclei became, the more their positive charges would repel each other.¹⁰⁴

In 1948, the follow-on theory assumed that a big bang produced *only neutrons*.¹⁰⁷ A free neutron decays in about 10 minutes, becoming a proton, an electron, and a particle (an antineutrino) that we can disregard in this discussion. Supposedly, protons and neutrons slowly merged to become heavier and heavier elements. Later, that theory was abandoned when it was realized that any nucleus with a total of five or eight nucleons (protons or neutrons) would decay and lose one or more nucleons in about a second or less.¹⁰⁸

Lineaments

Rock is strong in compression, but weak in tension. Therefore, one might think that fluttering hydroplates should have quickly failed in tension—along the red line in Figure 210. That is only partially correct. One must also recognize that compressive stresses increase with depth, because of the weight of overlying rock. The stress at each point within a hydroplate, then, was the compressive stress due to depth plus the cyclic stress due to flutter.

Yes, tension fractures occurred at the top of each hydroplate, and the sounds and shocks must have been terrifying. However, those cracks met greater and greater compressive resistance as they tried to grow downward. Remember, tension cracks generally cannot grow through compressed material. Cracks at the top of arched hydroplates became lines of bending weakness, so flexing along those lines was great. *These cracks in a geographical region tended to be parallel.*

As early as the 1930s, aerial photographs of Earth's surface showed groups of linear features—slight color discontinuities that were fairly straight, *often parallel to one of a few directions*, and up to dozens of miles in length. These lines must be *recent* fractures of some sort, because they are thin paths along which natural gas and even radon¹⁰⁵ sometimes leak upward. The cracks are difficult to identify on the ground, because they do not correspond to terrain, geological, or man-made features, nor do they show displacements, as do faults. However, earthquakes tend to occur along them.¹⁰⁶ Their origin has been unknown, so they were given the innocuous name *lineaments* (LIN-ee-uh-ments). Improved satellite, photographic, and computer technologies are revealing tens of millions of lineaments throughout the Earth's solid surface. [See Figure 220 on page 412.]

What gigantic stresses fractured so much rock? Several possibilities come to mind:

- Compression. But compressive failure (crushing or impacts) would not produce long, thin cracks.
- Shearing. But shearing would produce displacements.
- Horizontal Tension. But horizontal tension would pull a slab of rock apart at the instant of failure.
- Tension in Bending. Bingo!

Lineaments seem to be tension cracks formed by the fluttering of the crust during the early weeks of the flood. Later, other stresses probably produced slippage (faults and earthquakes) along some former lineaments.

Simply stated, growing a nucleus by adding one nucleon at a time encounters barriers at 5 and 8 atomic mass units.

The next theory said that a big bang produced *only hydrogen*. Much later, stars evolved. They fused this hydrogen into helium, which usually has four nucleons (two protons and two neutrons). If three helium nuclei quickly merged, producing a nucleus weighing 12 AMU, these barriers at 5 and 8 AMU could be jumped. This theory was abandoned when calculations showed that the entire process, especially the production of enough helium inside stars, would take too long.

A fourth theory assumed that two helium nuclei and several neutrons might merge when helium-rich stars exploded as supernovas. This theory was abandoned when calculations showed that to produce only the required helium, stars needed to generate much more heat than they could produce in their lifetimes.¹⁰⁹

The current evolutionary theory for Earth's radioactivity, first proposed in 1952, has the big bang producing only hydrogen, helium, and a trace of lithium. Inside stars, two helium nuclei sometimes merge briefly (for about 7×10^{-17} of a second—less than a billionth of a ten-millionth of a second). If (and what a big “if” that is!), during this brief instant, a third alpha particle merges with the first two, carbon will be formed. But how that triple-alpha process could happen is a mystery.

But exactly how each of these reactions happens at a fundamental level remains unexplained [because all the colliding positively charged nuclei would repel each other].¹¹⁰

This mechanism has not been verified experimentally or computationally.¹¹¹ Why then, with no scientific support, is this mechanism taught as if it were a fact? Chemical elements had to form somehow. If they did not “*evolve*,” how did chemical elements get here? This mechanism, as with all prior guesses that were taught widely and are now rejected, is born out of desperation, because creation, the alternative to chemicals evolving, is unacceptable to many.

Even if this problem did not exist, only chemical elements *lighter than 60 AMU* could be formed—by adding more protons, neutrons, and alpha particles (*but only if stars had somehow formed*). Pages 27–36 explain why stars, galaxies, and planets would not form from the debris of a big bang.

Assuming the formation of stars and the highly improbable triple collision of alpha particles at a rapid enough rate, stars “burning” hydrogen for billions of years might theoretically produce the rest of the 26 or so lightest chemical elements. But fusion inside stars must stop when nuclei reach about 26 AMU. How the 68 other naturally-occurring chemical elements (those heavier than iron) were produced is not known.¹¹⁴ Charles Seife explains:

How Evolutionists Explain Chemical Evolution

In the 1920s, Edwin Hubble discovered that the universe was expanding. This meant that the farther back we look in time, the smaller—and hotter—the universe was. For some time after the big bang (about 13.8-billion years ago), matter was so hot that atoms and nuclei could not hold together. All this was confirmed in 1965 when Arno Penzias and Robert Wilson discovered the cosmic microwave background radiation—the afterglow of the big bang. Both received a Nobel Prize for their discovery.

Because hydrogen is easily the most abundant element in the universe today, it is reasonable to assume that all elements and their isotopes evolved from hydrogen (^1H).¹¹² During the first three minutes after the big bang, temperatures were so hot that deuterium (^2H) could not have formed, because the average energy per nucleon exceeded the binding energy of deuterium. Impacts instantly fragmented any deuterium that formed, so during this “deuterium bottleneck” nothing heavier was made. However, during the next 17 minutes, the universe expanded and cooled enough for deuterium to begin forming; the available deuterium quickly “burned” to produce helium. That ended 20 minutes after the big bang when the universe had expanded enough to stop helium production.

The amount of deuterium we see also points to the big bang as the only possible source, because too much deuterium exists—especially here on Earth and in comets—to have been made in stars or by processes operating today.

*Deuterium (or heavy hydrogen) is a fragile isotope that cannot survive the high temperatures achieved at the centers of stars. Stars do not make deuterium; they only destroy it.*¹¹³

So, the big bang produced the three lightest chemical elements: hydrogen (including deuterium), helium, and lithium. Later, after stars evolved, the next 23 lightest chemical elements evolved deep in stars. Hundreds of millions of years later, all other chemical elements must have been produced by supernovas—the only other source available—because temperatures a hundred times greater than those in stars are required.¹¹⁴

*We are all made of starstuff. The big bang created hydrogen, helium, and a little bit of lithium and other light atoms. But everything else—the carbon, oxygen, and other elements that make up animals, plants, and Earth itself—was made by stars. The problem is that physicists aren't quite sure how stars did it.*¹¹⁵

Temperatures hundreds of times greater than those occurring inside stars are needed.¹¹⁶ Exploding stars, called *supernovas*, release extreme amounts of energy. Therefore, the latest chemical evolution theory assumes that supernovas produced the heavier chemical elements and then expelled them into the vacuum of space. By this thinking, radioactive atoms have been present throughout the Earth since it, the Sun, and the rest of the solar system evolved from scattered supernova debris. But Earth's mantle has little if any, radioactivity

[Response: Observations¹¹⁷ and computer simulations¹¹⁸ do not support this idea that supernovas produced all the heavy chemical elements. The extreme explosive power of supernovas should easily scatter and fragment nuclei, not drive nuclei together. Remember, nuclei heavier than iron are so large that the strong force can barely hold on to their outer protons. Also, the theoretical understanding of how stars and the solar system formed is seriously flawed. See pages 27–36.]

Evaluation of Evidence vs. Theories

We will test these two competing explanations for Earth's radioactivity by unambiguous observations, experimental evidence, and simple logic. Each issue, summarized below in italics and given a blue title, is examined from the perspective of the *hydroplate theory (HP)* and the *chemical evolution theory (CE)*. My subjective judgments, coded in green, yellow, and red circles (reminiscent of a traffic light's go, caution, and stop) simply provide a starting point for your own evaluations. Numbers in Table 23 refer to explanations that follow. Any satisfactory explanation for Earth's radioactivity should credibly address the italicized issues below. Please alter Table 23 by adding or removing evidence as you see fit.

Both theories will stretch the reader's imagination. Many will ask, “Could this really have happened?” Two suggestions: First, avoid the tendency to look for someone to tell you what to think. Instead, question everything yourself, starting with this book. Second, follow the evidence. Look for several “smoking guns.” I think you will find them.

Evidence Requiring an Explanation

Experimental Support. *Good theories have considerable experimental support.*

- **1. HP:** Every phenomenon involved in the hydroplate explanation for Earth's radioactivity is well understood and demonstrable: the piezoelectric effect, poling, nuclear combustion, heat absorption by fusion of heavy elements, electron capture, flutter with high compressive and tensile stresses, neutron production by bremsstrahlung radiation, Z-pinch, neutron activation analysis, rapid decay of artificially produced superheavy

Table 23. Evidence vs. Theories: Origin of Earth's Radioactivity

	Theories			
		Hydroplate Theory	Chemical Evolution	
Evidence to be Explained	Experimental Support	● 1	● 2	
	Quartz Alignment in Continental Crust	● 3	⊗ 4	
	Radioactivity Concentrated in Continental Crust	● 5	⊗ 6	
	Correlation of Heat Flow with Radioactivity	● 7	● 8	
	Ocean-Floor Heat	● 9	⊗ 10	
	Argon-40 (⁴⁰ Ar)	● 11	● 12	
	Oklo Natural "Reactor"	● 13	⊗ 14	
	Helium-3 (³ He)	● 15	⊗ 16	
	Zircon Characteristics	● 17	⊗ 18	
	Helium Retention in Zircons	● 19	⊗ 20	
	Isolated Polonium Halos	● 21	⊗ 22	
	Elliptical Halos	● 23	⊗ 24	
	Explosive Expansion	● 25	⊗ 26	
	Uranium-235 (²³⁵ U)	● 27	⊗ 28	
	Isotope Ratios	● 29	⊗ 30	
	Carbon-14 (¹⁴ C)	● 31	● 32	
	40 Extinct Radioisotopes	● 33	● 34	
	Chondrules	● 35	⊗ 36	
	Meteorites	● 37	⊗ 38	
	Close Supernova?	● 39	⊗ 40	
	Deuterium (² H)	● 41	⊗ 42	
	Oxygen-18 (¹⁸ O)	● 43	● 44	
	Lineaments	● 45	⊗ 46	
	Cold Mars	● 47	● 48	
	Distant Chemical Elements	● 49	● 50	
	The Salt Connection	● 51	⊗ 52	
	Rising Himalayas	● 53	⊗ 54	
	Forming Heavy Nuclei	● 55	⊗ 56	
	⁶ Li, ⁹ Be, ¹⁰ B, and ¹¹ B	● 57	⊗ 58	
	Pertains Primarily to One Theory:			
	Earthquakes and Electricity	● 59	N/A	
	Pegmatites	● 60	N/A	
Batholiths	● 61	N/A		
Radioactive Moon Rocks	● 62	N/A		
Inconsistent Dates	N/A	⊗ 63		
Baffin Island Rocks	N/A	⊗ 64		
Chemistry in the Sun	N/A	● 65		
Chemistry in Stars	N/A	● 66		
Star and Galaxy Formation	N/A	⊗ 67		
Big Bang: Foundation for Chemical Evolution	N/A	⊗ 68		

Key:

- Explained by theory.
- Theory has moderate problem with this item.
- ⊗ Theory has serious problems with this item.
- N/A Not Applicable

The numbers in this table refer to amplifying explanations on pages 400–416.

nuclei, and increased decay rates resulting from high voltages and concentrated electrical currents.

We know radioactive nuclei have excess energy, continually vibrate, and are always on the verge of “flying apart” (i.e., decaying). Atomic accelerators bombard nuclei; adding that energy produces radioisotopes and rapid decay.

- **2. CE:** We are dealing with variables such as temperature time, and size) in and around stars that are hundreds of thousands of times more massive than here on Earth. Therefore, experimental support for chemical evolution is necessarily limited. Experiments using particle colliders allow investigation of the interactions of subatomic particles traveling at great speeds. By using computer simulations and extrapolating the results of experiments to larger scales, we can infer of elements that would have been produced at extremely high temperatures inside huge stars billions of years ago.

Quartz Alignment in Continental Crust. *Why are quartz crystals aligned in most quartz-rich rocks?*⁸⁵

- **3. HP:** As explained in [Figure 213 on page 393](#), electric fields, from centuries of cyclic compression and tension (twice a day) before the flood, increasingly aligned quartz crystals in granite—a process called *poling*. Amazingly, laboratory tests have shown that alignments still exist even after the compression event and thousands of years.⁸⁵
- ⊗ **4. CE:** Electrical fields must have been present as Earth’s rocks solidified from a melt. The electrical fields would have aligned the quartz grains.

[Response: Granite consists of a mixture of millimeter-size mineral grains. *The isolated* quartz crystals we see today, would not have formed if the granite crust slowly cooled and solidified from a melt—even if a strong electrical field had been present. As the melt slowly cooled, each type of mineral would eventually solidify and either sink or float (depending on its density), thereby sorting into thick layers and very large crystals, such as pegmatites. Rapid cooling would have produced a rock called *rhyolite*. Granite cannot form from a melt.]

Radioactivity Concentrated in Continental Crust. *Why is Earth’s radioactivity concentrated in the continental crust?*

- **5. HP:** During the flood, powerful electrical discharges within the fluttering granite crust produced Earth’s radioactivity. Therefore, Earth’s radioactivity should be concentrated in the continental crust.

Earth’s ocean floors and mantle have little radioactivity, because they did not flutter and they contain little to no quartz, so they could not produce strong electrical discharges. Also, the subterranean water absorbed most neutrons generated in the fluttering crust, so there is little radioactivity below Earth’s crust.

- ⊗ **6. CE:** Stars produced radioisotopes. Later, Earth formed from the debris of exploded stars—“starstuff.” What concentrated Earth’s radioactivity in the continental crust is unclear.⁴⁵

[Response: If Earth formed from the debris of exploded stars, radioactivity should be distributed throughout the Earth, not concentrated in the crust.]

Correlation of Heat Flow with Radioactivity. *Heat flowing out of the Earth at specific continental locations correlates with the radioactivity in surface rocks at those locations.*

- **7. HP:** Electrical discharges within the crust generated both heat and radioactivity. The more electrical current at a location, the more radioactivity and heat produced. Therefore, the heat flowing up through the Earth’s surface should correlate with radioactivity at the Earth’s surface.
- **8. CE:** The following may explain this correlation:
 - ◆ slow radioactive decay generated some of the heat flowing out of the Earth,
 - ◆ each vertical column immediately below Earth’s surface has a different but uniform amount of radioactivity,
 - ◆ radioactivity varies widely over horizontal distances as short as 50 miles, and
 - ◆ enough time has passed to conduct most of that deep heat up to the surface.

If so, radioactivity goes only 4.68 miles down.¹¹⁹ If it went much deeper, the heat coming out at the surface, after just a few million years of radioactive decay, would be much more than is coming out today.

Although it is unlikely that all radioactivity is concentrated in Earth’s top 4.68 miles, radioactivity may decrease with depth, allowing even more time (consistent with the great age of the Earth) for that deeper heat to flow to the surface. Millions of such variations could be imagined, but all visualize radioactivity as being concentrated near the surface.

[Response: Millions of years would be required for the heat to flow up 4.68 or more miles.¹²⁰ If that much time elapsed, some locations would have eroded more than others. Arthur Lachenbruch has shown that millions of years of surface erosion would destroy the correlation unless radioactivity decreased exponentially with depth.¹²¹ If so, too much time would be required for the deeper heat generated to reach the surface. However, Germany’s Deep Drilling Program found that variations in radioactivity depended on the rock type, not depth.¹²²]

Ocean-Floor Heat. *Continental (granitic) rocks have much more radioactivity than the ocean floors, so why is slightly more heat coming up through the ocean floors than through the granite continents?*

- **9. HP:** During and soon after the flood, deep frictional deformation below the ocean floors produced heat that

is coming up through the ocean floors today. [See “**Magma Production and Movement**” on page 156.] The granite crust contains almost all of Earth's radioactivity, because piezoelectric effects in the fluttering crust released powerful electrical discharges within granite and generated Earth's radioactivity.

- ⊗ **10. CE:** Much of the heat coming up from within the Earth is produced by radioactive decay. Yet, Stacey has admitted:

*The equality of the continental and oceanic heat flows is puzzling in view of the great disparity in the total amounts of the radioactive elements uranium, thorium, and potassium in the continental [granitic] and oceanic [basaltic] crusts.*¹²³

[Response: Stacey's data actually show that the oceanic heat flow is slightly greater than that coming up through the continents.]

Argon-40 (⁴⁰Ar). Today, ⁴⁰Ar is produced almost entirely by the decay of potassium-40 (⁴⁰K) by electron capture. Earth does not appear to have enough ⁴⁰K to produce all the ⁴⁰Ar in our atmosphere—even if the Earth were twice as old as evolutionists claim. Saturn's moon, Enceladus, also has too much ⁴⁰Ar but not enough ⁴⁰K.

- **11. HP:** ⁴⁰K was produced in several ways as the crust was fluttering during the global flood. Z-pinching from the powerful electrical surges produced superheavy elements. Because they were all too proton-heavy, they quickly fissioned into thousands of isotopes, including radioactive isotopes. Some would have been ⁴⁰K.

⁴⁰K was also produced in other ways. Calcium is the fifth most abundant element in the Earth's crust, 97% of which is calcium-40 (⁴⁰Ca). Most calcium came from the subterranean chamber, the source of Earth's vast limestone (CaCO₃) deposits. [See “**The Origin of Limestone**” on pages 259–266.] Each ⁴⁰Ca nucleus that captured an electron during the electrical surges became ⁴⁰K.

Regardless of how ⁴⁰K formed, it would have become ⁴⁰Ar by capturing an electron during the electrical surges in Earth's fluttering crust. Consequently, ⁴⁰Ar was produced almost simultaneously with the production of ⁴⁰K. (Argon is a noble gas, so none of its 24 isotopes react chemically with other elements.) Much of the abundant ⁴⁰Ar was able to escape into the atmosphere, so today ⁴⁰Ar is the third most abundant gas in Earth's atmosphere (not counting water vapor).

Today, about 5,000 years after the flood and that electrical storm in Earth's crust, ⁴⁰K rarely captures an electron, so ⁴⁰K decays slowly to ⁴⁰Ar with a half-life of 1.3-billion years. Those who do not understand how almost all ⁴⁰K and ⁴⁰Ar were rapidly produced during the flood, frequently find much ⁴⁰Ar alongside ⁴⁰K.

Extremely Cold Fountains

A fluid flowing in a uniform channel expands if the fluid particles accelerate as they pass some point in the flow. For example, a water droplet in a waterfall will move farther and farther from a second droplet right behind it, because the first droplet had a head start in its acceleration.

Refrigerators and air conditioners work on this principle. A gas is compressed and therefore heated. The heat is then transferred to a colder body. Finally, the fluid accelerates and expands through a nozzle as a fountain, becomes cold, and cools your refrigerator or home.

The fountains of the great deep, instead of expanding from a few hundred pounds per square inch (psi) into a small, closed container, such as your refrigerator or air conditioner, expanded explosively from 300,000 psi into the atmosphere and outer space. The fountain's thermal energy became kinetic energy, reached extremely high velocities, and became exceedingly cold.

During the initial weeks of the flood, the escaping subterranean water's phenomenal acceleration and expansion were initially horizontal under the crust, then upward in the fountains of the great deep. (Remember, two astounding energy sources accelerated the fountains to at least 32 miles per second within seconds: (1) tidal pumping that stored energy in supercritical water before the flood and (2) nuclear energy generated during the first few weeks of the flood.) In this explosive expansion, most of the initially hot subterranean water in the fountains dropped to a temperature of almost absolute zero (-460°F), producing the extremely cold ice that fell on, buried, and froze the mammoths. [See “**Why Did It Get So Cold So Quickly?**” on page 280 and “**Rocket Science**” on pages 581–582.]

They argue that it was produced by the slow decay of ⁴⁰K after molten rock solidified, because argon would have bubbled out of any molten material. But molten rock produced during the flood (and therefore under water and pressure) would not have been able to release its dissolved ⁴⁰Ar. Molten rock in contact with liquid water would instantly form a crust at the water-rock interface that would prevent ⁴⁰Ar's escape.

So one might mistakenly think that rock was billions of years old if they dated it by the potassium-argon dating technique, because it contained so much argon that *today* only builds up slowly when ⁴⁰K decays with a half-life of 1.3-billion years. Actually the rock formed soon after the flood began in 3290 B.C [See page 482.]

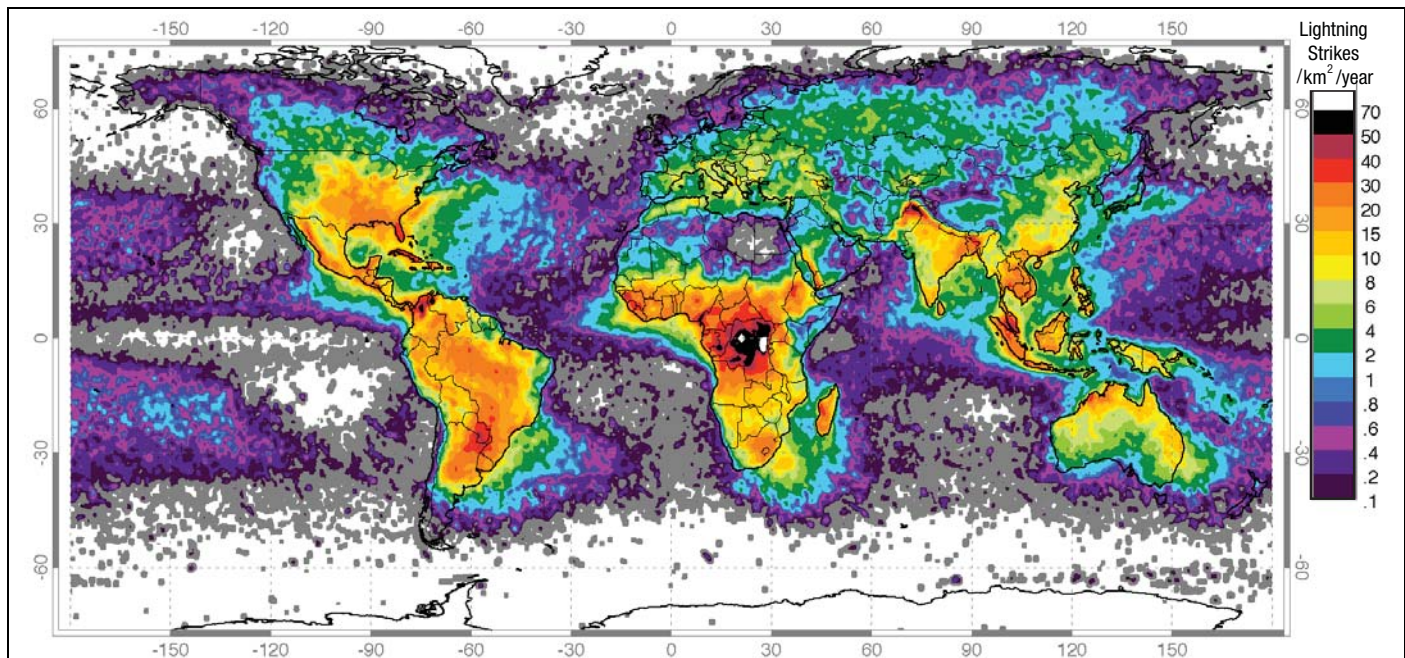

Figure 218: Lightning Frequency. Today, more lightning strikes occur along the equator in central Africa than anywhere else on Earth— more than 100 strikes per square kilometer each year. The center of this region is only about 1000 miles east of Oklo. Probably more violent electrical storms occurred farther to the west soon after the flood, as warmer moist air rising off the Atlantic collided with the cold air above the temporarily high continent of Africa.

As for lava flows that have occurred since the flood, the potassium-argon dating technique is seldom used if the rock is thought to be younger than 100,000 years.

- **12. CE:** The argon on Enceladus needs to be remeasured.

Crustal rocks contain little potassium-40, but the mantle may contain much more. Furthermore, *if about 66% of the mantle's ^{40}Ar escaped into the atmosphere, both the atmosphere's ^{40}Ar and the needed ^{40}K in the Earth's crust and mantle could be explained.*¹²⁴

[Response: This 66% proposal is ridiculous, because argon, a large atom, is easily trapped between mineral grains and within crystal structures. Indeed, the potassium-argon dating method is used, because solids retain argon over long periods.]

Oklo Natural "Reactor." *Can Oklo be explained? Why haven't other uranium deposits become nuclear reactors?*

- **13. HP:** Today, a region near Oklo receives more lightning strikes than anywhere else on Earth. [See Figure 218] For centuries after the flood, warm oceans and heavy precipitation (explained on page 140) would have generated even more frequent and severe thunderstorms. As lightning strikes passed down through the thin layer of uranium ore, bremsstrahlung radiation¹²⁵ accelerated radioactive decay and released neutrons, as explained on pages 390 and 398. Those neutrons then fissioned ^{235}U and initiated brief, *subcritical*

chain reactions. Their consequences are detected in *isolated* zones within 30 kilometers of the Oklo mine.

Lightning strikes would also explain why the ratio of ^{235}U to ^{238}U at Oklo varied a thousandfold over distances of less than a thousandth of an inch.⁵⁵ Lightning branches successively into thousands of thin, fractal-like paths, some quite close together.

- **14. CE:** Today, 0.72% of natural uranium is ^{235}U . Because ^{235}U decays faster than the more abundant ^{238}U , a higher percentage of uranium would have been ^{235}U in the past. About 2-billion years ago, 3.7% of all uranium worldwide would have been ^{235}U , enough for uranium deposits to "go critical" if other factors were favorable. One important factor is having water saturate the uranium ore. If the ore "went critical" and heated up, the water would evaporate, so the reactor would shut down and cool off. This cycle may have repeated itself many times. When the Earth's crust solidified at least 3.8-billion years ago, even more ^{235}U was concentrated. Why hundreds of other uranium ore deposits did not become natural reactors is a mystery.

[Response: Such cycles would not produce temperature variations and power surges as extreme as Harms found them to have been.⁵⁶ Certainly, we would not expect to see thousandfold variations in the ratio of ^{235}U to ^{238}U over distances of less than a thousandth of an inch, especially after 2-billion years.

Test Question:

If you have read pages 394–395 and understand the enormous power of the fountains of the great deep, can you spot the error in the following paragraph?

Page 394 states that the fountains of the great deep contained 1,800 trillion hydrogen bombs worth of kinetic energy—or more than 7.72×10^{37} ergs. Let's be generous and assume that only 0.00001 percent of that energy was transferred to Earth's atmosphere. Simple calculations show that adding that much energy to Earth's atmosphere would destroy all life.

Answer: Understanding Inertia. We have all seen a performer jerk a tablecloth out from under plates and goblets resting on a beautifully set table. The plates and goblets barely moved, because they have inertia. What would happen if the performer yanked the table cloth out a trillion times faster? The plates wouldn't move.

The horizontal acceleration of the table cloth is analogous to the upward acceleration of the fountains of the great deep. Because the atmosphere has mass, and therefore inertia, the faster the fountains jetted, the less the bulk of the atmosphere would have been disturbed.

Supercritical water in the subterranean chamber (at the base of the fountains) was extremely hot. However, that water expanded and cooled as it accelerated upward—becoming extremely cold, almost absolute zero. [See “**Rocket Science**” on pages 581–582.] As the fountains passed up through the lower atmosphere (60 miles above the subterranean chamber), the water's temperature would have been somewhere between those two extremes. We know that the ice that fell on and buried the frozen mammoths was about -150°F ., so the fountain's temperature was warmer as it passed through the lower atmosphere. Heat transfer through gases is quite slow, so probably little heat was transferred from the somewhat warmer atmosphere to the colder, rapidly moving fountains.

Disposal of radioactive waste from nuclear reactors is a serious environmental problem. Few believe that any geological formation can contain radioactive waste for 100,000 years—even if held in thick, steel containers encased in concrete. However, at Oklo, most products of ^{235}U decay have not migrated far from the uranium deposit,¹²⁷ despite 2-billion years of assumed time.]

Helium-3 (^3He). ^3He production begins with a nuclear reaction that yields ^3H , which then beta decays to ^3He .⁴¹ So why is ^3He common inside the Earth, why are black smokers expelling

One Type of Fusion Reactor

The *shock collapse mechanism* is similar to a technique, called *magnetized target fusion* (MTF), planned for a fusion reactor. In one version of an MTF reactor—a machine that some believe “might save the world”¹²⁶—a plasma of heavy hydrogen will be injected into the center of a 10-foot-diameter metal sphere containing spinning liquid metal. Two hundred pistons, each weighing more than a ton, surround the sphere, and will simultaneously send converging shock waves into the center of the sphere at 100 meters per second. There, the plasma will compress the heavy hydrogen so much that it fuses into helium and releases an immense amount of heat. This cycle will be repeated every second.

Unfortunately, an MTF reactor must expend energy operating 200 pistons which, with all their moving parts (each subject to failure), must fire almost simultaneously—within a millionth of a second. However, during the flood, the electrical, lightninglike surges produced thin channels of hot, high-pressure plasma that expanded the surrounding rock. Then, that rock rebounded back onto plasma-filled channels, producing **shock collapse**—and fusion.

With shock collapse, the channel walls collapsed onto the plasma from all directions—at trillions of points. With MTF, hundreds of moving parts must act nearly simultaneously for the collapse to occur at one point.

large amounts of ^3He , and why does the ratio of ^3He to ^4He (neither of which decays) vary so widely inside the Earth?

- **15. HP:** During the flood, many nuclear reactions occurred inside the fluttering crust and in the porous floor of the subterranean chamber. Today, black smokers expel ^3He and SCW from that porous floor. ^3He also escapes to the Earth's surface along faults in the crust, so the amount of ^3He varies widely at different locations.
- ⊗ **16. CE:** Nuclear reactions seldom occur inside the Earth, so ^3He must be primordial—originating from the very beginning (the big bang).¹²⁸ The Earth grew and evolved by meteoritic bombardment. Therefore, ^3He was brought to the Earth as it evolved by meteoritic bombardment.

[Response: The premise that “nuclear reactions seldom occur inside the Earth” is wrong. The hydroplate theory explains how nuclear reactions occurred inside the fluttering crust during the flood, thus producing ^3He .

How could helium, a light, inert gas, have been trapped in meteoritic material or in a supposedly molten Earth, where it would bubble to the surface?⁴² Even if helium became

trapped in an evolving Earth, why would the ratio of ^3He to ^4He vary so widely from location to location? If the mantle is circulating, as textbooks erroneously teach, the small amount of ^3He should be so diluted it would be undetectable.⁴⁴

One theory, which has gained little support, claims that a natural uranium reactor, 5 miles in diameter, has been operating at the center of the Earth for 4.5-billion years. The lighter fission products from that reactor, such as ^3He , supposedly migrated up 4,000 miles, primarily through solid rock. One problem with this idea is that any ^3He produced near a neutron source would readily absorb a neutron and become ^4He . The hypothetical reactor would provide those neutrons, as would any fissioning material (such as uranium or thorium) near the ^3He 's 4,000-mile upward path. Likewise, ^3He atoms that somehow fell to the Earth 4,500,000,000 years ago would have to avoid free neutrons for a long time.]

Zircon Characteristics. *Why do zircons found in Western Australia contain strange isotopes and microdiamonds?*

● **17. HP:** Inside these zircons, more uranium and thorium decayed than almost anywhere else on Earth. If that decay always occurred at today's rates, as evolutionists maintain, then those zircons formed back when the Earth was probably too hot to form zircons—a logical contradiction. Therefore, at some time in the past, decay rates must have been much faster.

The compression event or shock collapse (explained on page 392) likely produced the high pressures required to form microdiamonds. Minerals and isotopes in these zircons show that water and granite were also present.³⁸ The low ratio of ^{13}C to ^{12}C suggests that all these carbon isotopes were not originally present. Therefore, at least some carbon isotopes were produced or consumed, and that implies nuclear reactions. These zircons and their contents probably formed in the plasma channels “drilled” by the electrical discharges at the beginning of the flood.

⊗ **18. CE:** Organic matter contains low ratios of ^{13}C to ^{12}C . Therefore, the presence of water and the low ratio of ^{13}C to ^{12}C could imply that life was present on Earth long before we evolutionists thought.

Although the Earth was extremely hot 4.0–4.4-billion years ago, some regions, such as above ocean trenches, where the geothermal heat flow is up to 17% lower than normal, must have been cold enough to crystallize zircons.¹²⁹ If so, plate tectonics operated two billion years before we thought, although ancient trenches have never been found. [See “**Fossil (Ancient) Trenches**” on page 177.]

Helium Retention in Zircons. *Based on today's slow decay rates of uranium and thorium in zircons, some zircons are claimed to be 1.5-billion years old, but their age, based on*

the diffusion of helium out of those same porous zircons, was only 4,000–8,000 years.⁴⁰

● **19. HP:** About 5,000 years ago, electrical discharges within the crust produced accelerated decay (1) during the weeks the crust fluttered at the beginning of the flood, and (2) during the sudden compression event near the end of the flood. Helium produced by the decay of uranium and thorium in zircons, is still diffusing out. Very little helium has escaped from zircons, because little time has passed since the flood. [See “**Helium**” on page 39.]

⊗ **20. CE:** Only a few helium diffusion rates in zircons have been measured. Besides, those few measurements were not made under the high pressures that exist 1–2 miles inside the Earth. Helium cannot escape rapidly through cracks in zircons under high pressures, so closed cracks could explain why so much has been retained in 1.5-billion-year-old zircons. If the diffusion rates measured in the laboratory are 100,000 times too high, the discrepancy would be explained.

[Response: Such large errors are unlikely, and hard, tiny zircons have few cracks, even at atmospheric pressure.]

Isolated Polonium Halos. *Polonium-218, -214, and -210, (^{218}Po , ^{214}Po , and ^{210}Po) decay with half-lives of 3.1 minutes, 0.000164 seconds, and 138 days, respectively. Why are their halos found without the parents of polonium?*

● **21. HP:** During the early weeks of the flood, electrical discharges throughout the fluttering crust produced thin plasma channels in which superheavy (extremely unstable) elements formed. Then, they quickly fissioned and decayed into many relatively lighter elements, such as uranium.

Near the end of the flood, the compression event crushed and fractured rock, producing additional piezoelectric discharges, bremsstrahlung radiation and accelerated radioactive decay. Hot SCW (held in the spongelike voids in the lower crust) and ^{222}Rn (an inert gas produced in plasma channels) were forced up through these channels and fractures. As the mineral-rich water rose hours and days later, its pressure and temperature dropped, so minerals, such as biotite and fluorite, began forming in the channels. Wormlike myrmekite also formed as quartz and feldspars precipitated in the thin, threadlike channels “drilled” by the powerful electrical discharges and by SCW (a penetrating solvent).

In biotite, for example, why were a billion or so polonium atoms concentrated at each point that quickly became the center of an isolated polonium halo? Why didn't each halo melt in minutes as hundreds of millions of alpha particles were emitted? In a word, *water*.

Biotite requires water to form. Within biotite, water (H_2O or HOH) breaks into H^+ and OH^- . The OH^- (called *hydroxide*) occupies trillions upon trillions of

repetitive positions within biotite's crystalline structure. Other water (liquid and gas) transported ^{222}Rn (which decayed with a half-life of 3.8 days) between the thin biotite sheets *as they were forming*.

Radon gas is inert, so it has no electrical charge. When ^{222}Rn ejects an alpha particle, 5.49 MeV of kinetic energy is released, and ^{222}Rn instantly becomes ^{218}Po with a -2 electrical charge.

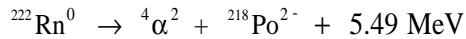

Because both energy and linear momentum are conserved, 2% of that energy was transferred to the recoiling polonium nucleus, sometimes embedding it in an adjacent biotite sheet. That recoil energy was so great and so concentrated that it released thousands of hydroxide particles, each with one negative electrical charge.¹³⁰ Flowing water cooled the biotite and swept away the negatively charged hydroxide. The large number of positive charges remaining quickly attracted and held onto the newly formed polonium flowing by, each with a -2 electrical charge. Minutes later, the captured polonium decayed, expelled more hydroxide, and repeated the process. Within days, these points with large positive charges became the centers of parentless polonium halos. *Again, we see that the subterranean water is the key to solving this halo mystery.*¹³¹ [See “**Frequency of the Fluttering Crust**” on page 606.]

Similar events happened in other micas and granitic pegmatites. Likewise, the newly formed uranium atoms readily fit in the mineral zircon as it grew, because uranium's size and electrical charge (+4) fit nicely in the slots zirconium atoms (after which zircons are named) normally fill. Thorium also fits snugly.

Figure 207's caption (on page 388) states that both the ^{235}U decay series and the ^{232}Th decay series produce other polonium isotopes that decay in less than a second: ^{215}Po and ^{211}Po in the ^{235}U decay series and ^{216}Po and ^{212}Po in the ^{232}Th decay series. However, those isotopes produce few, if any, isolated polonium halos. Why are they missing, when isolated halos from ^{218}Po , ^{214}Po , and ^{210}Po in the ^{238}U decay series are abundant?

Again, radon and water provide the answer. Today, radon (^{219}Rn) in the ^{235}U decay series decays with a half-life of 3.96 seconds, and radon (^{220}Rn) in the ^{232}Th decay series decays with a half-life of 55.6 seconds—82,900 and 5,900 times faster, respectively, than the 3.8-day half-life of ^{222}Rn from the ^{238}U series. Therefore, ^{219}Rn and ^{220}Rn can't travel far as they look for growing sheets of biotite (or similar minerals) with extremely concentrated, positive electrical charges to attract radon's negatively charged polonium daughters.

Indeed, as explained on page 388, Henderson and Sparks discovered that the isotopes that produced

Recoil

Just as a rifle recoils when it fires a bullet, a free ^{222}Rn nucleus will also recoil when it expels an alpha particle. The ^{222}Rn nucleus then becomes ^{218}Po . Of the 5.49 MeV of kinetic energy released in this decay, the lighter alpha particle (acting as the bullet) receives 98% and the ^{218}Po (acting as the rifle) receives 2%.

If a ^{222}Rn nucleus decays while flowing between growing sheets of biotite, the new ^{218}Po nucleus could become embedded in the biotite. The concentrated heat and pressure from a crashing ^{218}Po are sufficient to remove hundreds, if not thousands, of hydroxide ions (OH^-) which are a major part of biotite's structure—a process called *dehydroxylation*.¹³⁰ Each removal carries away one negative charge, so the ^{218}Po 's impact point in biotite, which was initially electrically neutral, takes on a large positive charge and quickly attracts the negatively charged polonium atoms flowing by. (Each polonium nucleus initially has a -2 charge, because an alpha particle, which carries a +2 charge, was just expelled by the polonium atom's parent.) When embedded ^{218}Po atoms and their daughters decay, their recoil energy removes additional hydroxide particles, increasing the positive charges even more. [See “**Rapid Attraction**” on page 607.]

the isolated halos did flow in channels next to growing biotite sheets, because halo centers tended to cluster in a few sheets but were largely absent from nearby parallel sheets. Therefore, it again appears that certain biotite sheets took on increasing positive charges at specific impact points. Those points then rapidly attracted negatively charged polonium still flowing by. The electrical clustering of polonium, perhaps over days or weeks, produced isolated polonium halos. Later, the high-pressure water escaped, and adjacent sheets were compressed together and weakly “glued” (by hydroxide, a derivative of water) into “books” of biotite.

Collins' limited deductions, mentioned on page 389, are largely correct, although they raise the six questions italicized below. The hydroplate theory easily answers those questions.

- ♦ *What was the source of all that hot, flowing water, and how could it flow so rapidly up through rock?* Answer: When the flood began, water filled thin, spongelike channels in the lower crust—formed by the tremendous dissolving power of an ocean's worth of subterranean SCW. Other channels were “drilled” by the powerful electrical discharges and produced by fractures during the compression event. As the high-pressure water rose, the pressure inside the channels increasingly

exceeded the confining pressure of the channel walls, so those walls expanded. After the flood, the water cooled and escaped, so the channels slowly collapsed.

- ◆ *Why was the water ^{222}Rn rich?, because ^{222}Rn has a half-life of only 3.8 days? Answer: As described above, ^{222}Rn 's half-life still allowed it to be widely scattered. Secondly, because it carries no electrical charge, it does not combine chemically with other elements. However, when it encountered liquid water, it went into solution and traveled great distances in the high-pressure flow, usually upward.*
- ◆ *Because halos are in different geologic periods, did all this remarkable activity occur repeatedly, but at intervals of millions of years? If so, how? Answer: The millions of years are a fiction—a consequence of not understanding the origin of Earth's radioactivity and the accelerated decay processes.*
- ◆ *What concentrated a billion or so ^{218}Po atoms at each microscopic speck that became the center of an isolated polonium halo? The negatively charged polonium atoms were attracted to points with large positive charges. [See "Recoil" above.]*
- ◆ *Today's extremely slow decay of ^{238}U (with a half-life of 4.5-billion years) means that today its daughters, granddaughters, etc. form slowly. Were these microscopic specks the favored resting places for ^{218}Po for billions of years, or did the decay rate of ^{238}U somehow spike just before all that hot water flowed? Remember, ^{218}Po decays today with a half-life of only 3.1 minutes. Answer: As the flood began, electrical discharges instantly produced very unstable superheavy isotopes that rapidly fissioned and decayed—similar to the experiments of Dr. Fritz Bosch (in Germany), Dr. Stanislav Adamenko (in Ukraine), and William Barker (in the U.S.A.). The fission and decay products included many new isotopes (such as ^{222}Rn) and heavy chemical elements that did not exist before the flood.*
- ◆ *Why are isolated polonium halos associated with parallel and aligned myrmekite that resemble tiny ant tunnels? Answer: Before the flood, SCW easily dissolved certain minerals in granite (such as quartz and feldspars). During the flood, those hot solutions filled the extremely thin, nearly parallel channels that extended up from the subterranean chamber. After the flood, those solutions rose, evaporated, and cooled, while quartz and feldspars precipitated in some of those channels, becoming myrmekite.*
- ⊗ **22. CE:** Polonium halos are strange—but only a tiny mystery. Someday, we may understand them.

Elliptical Halos. *What accounts for the pair of overlapping ^{210}Po halos in coalified wood in the Rocky Mountains—one halo elliptical and the other spherical, each with the same center?*

- **23. HP:** Some spherical ^{210}Po halos formed in wood that had soaked in water for months during the flood.

(Water-saturated wood, when compressed, deforms like a gel.) As the Rocky Mountains buckled up during the compression event, that "gel" was suddenly compressed. Within seconds, partially formed spherical halos became elliptical. Then, the remaining ^{210}Po (whose half-life today is 138 days, about the length of the flood phase) finished its decay by forming a spherical halo superimposed on the elliptical halo.

- ⊗ **24. CE:** Only one such set of halos has been found. Again, we consider this only a tiny mystery.

Explosive Expansion. *What accounts for the many random fractures surrounding minerals that experienced considerable radiation damage? [See Figure 208 on page 390.]*

- **25. HP:** Radiation damage in a mineral distorts and expands its lattice structure, just as well-organized, tightly-stacked blocks take up more space after someone suddenly shakes them.⁷⁷ Ramdohr explained how a slow expansion over many years would produce fractures along only grain boundaries and planes of weakness, but a sudden, explosive expansion would produce the fractures he observed.

Accelerated decay, explained on page 398, produced that sudden radiation damage—and heating.

- ⊗ **26. CE:** Ramdohr's observations have not been widely studied or discussed by other researchers.

Uranium-235 (^{235}U). *If the Earth is 4.5-billion years old and ^{235}U was produced and scattered by some supernova explosion billions of years earlier, ^{235}U 's half-life of 700 million years is relatively short. Why is ^{235}U still around, how did it get here, what concentrated it in ore bodies on Earth, and why do we not see much more lead associated with the uranium? (Observations and computer simulations¹¹⁸ show that few of the 75 heaviest chemical elements—including uranium—are produced and expelled by supernovas!)*

- **27. HP:** During the flood, about 5,000 years ago, electrical discharges (generated by the piezoelectric effect)—followed by fusion, fission, and accelerated decay—produced ^{235}U and most of Earth's other radioisotopes.
- ⊗ **28. CE:** We cannot guess what happened so long ago and so far away in such a hot (supernova) environment.

[Response: Evolution theory is filled with such guesses, but usually they are not identified as guesses. Instead, they are couched in impressive scientific terminology, hidden behind a vast veil of unimaginable time, and placed in textbooks. Radioactive decay can be likened to rocks tumbling down a hill, or air leaking from a balloon. Something must first lift the rocks or inflate the balloon. Experimental support is lacking for the claim that all this happened in a distant stellar explosion

billions of years ago and somehow uranium was concentrated in relatively tiny ore bodies on Earth.]

Isotope Ratios. *The ratio of the amounts of ^{234}U to ^{238}U in uranium ore deposits is amazingly constant worldwide. One very precise study showed that the ratio is 0.0072842, with a standard deviation of only 0.000017.¹³² Other uranium isotope ratios are also constant. How could that be?*

- **29. HP:** Obviously, the more time that elapses between the formation of the various isotopes (such as ^{234}U and ^{238}U) and the farther they are transported to their final resting places, the more varied those ratios should be. The belief that these isotopes formed in a supernova explosion millions of light-years away and billions of years before the Earth formed and then somehow collected in small ore bodies in a fixed ratio is absurd. Besides, powerful explosions would have separated the lighter isotopes from the heavier isotopes.

Some radioisotopes simultaneously produce two or more daughters. When that happens, the daughters have very precise ratios to each other, called *branching ratios* or *branching fractions*. Uranium isotopes are an example, because they are daughter products of some even heavier element. Recall that the Proton-21 Laboratory produced superheavy elements that instantly decayed. Also, the global flux of neutrons during the flood provided nuclei with enough neutrons to reach their maximum stability. This explains why uranium isotope ratios in ore bodies are fixed. Had the flux of neutrons originated in outer space, we would not see these constant ratios worldwide. Because these neutrons originated throughout the globe-encircling fluttering granite crust, these fixed ratios are global.

Conclusion: Uranium is the daughter product of the now extinct element-184, the heaviest chemical element detected by man, either directly or indirectly. We will call it *Proto-Uranium*.

- ⊗ **30. CE:** Maybe Uranium didn't form light years away, billions of years ago.

Carbon-14 (^{14}C). *Why do radiocarbon dates frequently conflict with dates based on other radiometric dating techniques?*

- **31. HP:** Radiocarbon resides primarily in the atmosphere, oceans, and organic matter. Therefore, electrical discharges within the crust at the beginning of the flood did not affect radiocarbon. However, those discharges and the resulting "storm" neutrons and bremsstrahlung radiation in the crust produced almost all of Earth's other radioisotopes, disturbed their tenuous stability, and allowed them to rapidly decay—much like a sudden storm with pounding rain and turbulent wind might cause rocks to tumble down a mountainside.

This is why very precise radiocarbon dating—atomic mass spectrometry (AMS), which counts individual

atoms—gives ages that are typically 10–1000 times younger than all other radiometric dating techniques (uranium-to-lead, potassium-to-argon, etc.).

- **32. CE:** That radiocarbon may be contaminated.

[Response: Before radiocarbon's precision was increased by AMS, some attributed this thousandfold conflict to contamination. Studies have now ruled out virtually every proposed contamination source.²⁵]

Forty Extinct Radioisotopes *Forty different radioisotopes each produce unique decay products that are found on Earth, but those radioisotopes are extinct. Based on nuclear experiments, the half-lives of those 40 radioisotopes are so long that they should still be around if the Earth is less than 10,000 years old.¹³³ Does this mean that the Earth is much older than 10,000 years?*

- **33. HP:** That would be true if decay rates had always been what they are today. One must first understand that radioisotopes continually vibrate and all will eventually decay. Electrical surges, produced during the flood's compression event, generated bremsstrahlung radiation which excited the more unstable radioisotopes, causing them to quickly decay. Therefore, they are not found in nature, but their stable decay products are.
- **34. CE:** If Earth were less than 10,000 years old, those 40 radioisotopes should still be here, because they would not have had enough half-lives to completely disappear. Only if the Earth were billions of years old, would they all have decayed. This shows that the Earth is billions of years old.

[Response: That explanation shows a lack of understanding of accelerated radioactive decay. See page 398.]

Chondrules *How did chondrules form?*

- **35. HP:** See "Chondrules" on page 410.
- ⊗ **36. CE:** Because chondrules are in meteorites that have even older radiometric ages than Earth, chondrules are the oldest solid material in the solar system. Although chondrules evolved in outer space where temperatures are almost -460°F (492°F below freezing), they required sudden melting temperatures of at least $3,000^\circ\text{F}$. It is hard to look back that far and determine what could have formed pieces of rock a few millimeters in diameter, quickly melted that rock, and then encased those liquid droplets in other rock.

[Response: The mystery is solved when one understands the origin of Earth's radioactivity.]

Meteorites. *Radioactive decay products in some meteorites require more time to accumulate—at today's decay rates—than any other rocks ever found in the solar system.*

- **37. HP:** Electrical surges, not time, produced the high concentration of decay products in some meteorites.

Chondrules



Figure 219: Chondrules. The central chondrule above is 2.2 millimeters in diameter, the size of this circle: ●. This picture was taken in reflected light. However, meteorites containing chondrules can be thinly sliced and polished, to allow light to pass through the thin slice and into the microscope. Such light becomes polarized as it passes through the minerals. The resulting colors identify minerals in and around the chondrules. [Meteorite from Hammada al Hamra Plateau, Libya.]

How would you like your decades of research on a field's central problem to be summed up by the statement that "these objects [chondrules] remain as enigmatic as ever"? That was part of the title of a session on the formation of chondrules at the 75th annual Meteoritical Society meeting last year.¹³⁴

Those experts still are missing the answer. Chondrules (CON-drools) are strange, nearly spherical, BB-size objects found in 85% of all meteorites. To understand the origin of meteorites, we must also know how chondrules formed.

Their spherical shape and texture show they were once molten, but to melt chondrules requires temperatures exceeding 3,000°F. How could chondrules get that hot without melting the surrounding rock, which usually has a lower melting temperature? Because chondrules still contain volatile substances that would have bubbled out of melted rock, chondrules must have melted and cooled quite rapidly¹³⁵—in about one-hundredth of a second.¹³⁶

The Standard Explanation and Its Recognized Problems. Small pieces of rock, moving in outer space billions of years ago, before the Sun and Earth formed, suddenly and mysteriously melted. These liquid droplets quickly cooled, solidified, and then were encased inside the rock that now surrounds them.

Such vague conditions, hidden behind a veil of space and time, make it nearly impossible to test in a laboratory. Scientists recognize that this standard story does not explain the rapid melting and cooling of chondrules or how they were encased uniformly in rocks which are

radiometrically older than the chondrules.¹³⁷ As one scientist wrote, "The heat source of chondrule melting remains uncertain. We know from the petrological data that we are looking for a very rapid heating source, but what?"¹³⁸

Frequently, minerals grade (gradually change) across the boundaries between chondrules and surrounding material.¹³⁹ This suggests that chondrules melted while encased in rock. If so, powerful heating sources must have acted briefly and been localized near the centers of what are now chondrules. But how could this have happened?

Hydroplate Theory. As the subterranean water escaped from under the crust, pillars had to carry more of the crust's weight, because the diminishing amount of high-pressure, subterranean water carried less of the crust's weight. Also, the crust, fluttering during the early weeks of the flood, repeatedly pounded pillars against the chamber floor, much like a 60-mile-thick sledge hammer pounding thick, tapered spikes again and again.

Each pounding produced new piezoelectric voltages and electrical surges greater than those occurring higher in the crust. As the Proton-21 Laboratory has demonstrated thousands of times, electron flows driven by only 50,000 volts will focus (Z-pinch) onto "hot dots" less than one ten-millionth of a millimeter in diameter. There, temperatures reach 3.5×10^8 K (630,000,000°F) for less than a billionth of a second. Then, the tiny electrodes explode and scatter a variety of new elements and isotopes. [See [Figure 205 on page 384](#).]

Such tiny concentrations of energy deep in massive, highly compressed pillars would not rupture the pillars. Instead, small volumes of rock melted. Hours or days later, crushed pillar fragments (rocks) were swept up by the escaping, accelerating supercritical water and launched into space where the encased liquid droplets rapidly cooled and became chondrules. Their tumbling action in the weightlessness of space, preserved their spherical shapes and prevented volatiles from bubbling out. Those rocks that fall back to Earth are called meteorites.

Researchers bold enough to propose a heating source that fits the evidence persistently mention lightning—some specifically see the need for Z-pinched lightning!¹⁴⁰

Some researchers have suggested a repeating, pulsed heat source, such as lightning bolts, but no consensus has been reached on the feasibility of generating lightning in the solar nebula.¹⁴¹

Of course, the solar nebula that evolutionists imagine would not have produced lightning powerful enough and focused enough to melt trillions upon trillions of pinpoints of rock. Nor is repeated lightning seen in regions of space comparable to the hypothetical solar nebula. The lightning occurred within Earth's fluttering crust as the flood began.

During the flood, pillars within the subterranean chamber experienced the most compression and electrical discharges, which, in turn, produced the greatest number of radioactive decay products. Most meteorites originated from crushed pillars, so more decay products formed in meteorites and deep sedimentary and crustal rocks (those that were closer to pillars). This is why radiometric ages generally increase with depth in the crust.

- ⊗ **38. CE:** Meteorites have the oldest known radiometric ages in the solar system, so meteorites must have evolved first. This is how we know the Earth evolved from meteorites and the solar system began 4.5-billion years ago.

[Response: How can gas and dust compact themselves into dense black rocks (asteroids and meteoroids) in the weightlessness of space? See “**The Origin of Asteroids and Meteoroids**” on pages 337–374.]

Close Supernova? Today, half of iron-60 (^{60}Fe) will decay into nickel-60 (^{60}Ni) in 1,500,000 years. In two meteorites, ^{60}Ni was found in minerals that initially contained ^{60}Fe .¹⁴² How could ^{60}Fe have been locked into crystals in those meteorites so quickly,¹⁴³ that measurable amounts of ^{60}Ni formed?

- **39. HP:** Accelerated radioactive decay began at the onset of the flood, not only in the fluttering crust but in the pounding and crushing of pillars. As explained on page 341, iron was a common element in pillar tips. During the electrical discharges, bremsstrahlung radiation produced a sea of neutrons throughout the crust. Those neutrons converted some stable iron (^{54}Fe , ^{56}Fe , ^{57}Fe , and ^{58}Fe) into ^{60}Fe which, because of accelerated decay, quickly became ^{60}Ni . Days later, pillar fragments were launched from Earth; some became meteorites.
- ⊗ **40. CE:** Iron was produced inside stars. A relatively few stars were so massive that they exploded as supernovas and expelled that iron as a gas into interstellar space. A few ten-millionths of that iron was ^{60}Fe . Before the ^{60}Fe could decay, some must have cooled and merged into dense rocks and crystallized. One of those supernovas had to be “stunningly close” to our solar system for the Sun to capture those rocks so they could later fall to Earth as meteorites.¹⁴⁴

[Response: How does gas from a supernova explosion, expanding at almost 20,000 miles per second, quickly merge¹⁴³ into dense rocks drifting in the vacuum of space? Why did a “stunningly close” supernova not distort, burn, or destroy our solar system? Why can't we see that nearby supernova's remnant?]

Deuterium (^2H). How did deuterium (heavy hydrogen) form, and why is its concentration in comets twice as great

as in Earth's oceans and 20–100 times greater than in interstellar space and the solar system as a whole?

- **41. HP:** Deuterium formed when the subterranean water absorbed a sea of fast neutrons during the early weeks of the flood. (Powerful bremsstrahlung radiation produces free neutrons, as explained beginning on page 390.) Comets later formed from some of the deuterium-rich water that was launched from Earth by the fountains of the great deep. Traces of that deuterium have been found on the Moon. [See Endnote 76 on page 331.] Most of the deuterium-rich, subterranean water mixed about 50–50 with Earth's surface waters to give us the high deuterium concentrations we have on Earth today. Meteorites are also rich in deuterium.¹⁴⁵
- ⊗ **42. CE:** The big bang produced deuterium 3–20 minutes after the universe began, 13.8-billion years ago. During those early minutes, most deuterium was consumed in forming helium. Billions of years later, deuterium that ended up in stars was destroyed. Some deuterium must have escaped that destruction, because comets and Earth have so much deuterium.

Oxygen-18 (^{18}O). What is the origin of ^{18}O and why is it concentrated in and around large salt deposits?

- **43. HP:** Before the flood, the supercritical subterranean water steadily “out-salted” thick layers of water-saturated minerals onto the chamber floor. This included salt crystals (NaCl). [See Endnote 53 on page 144.] The water trapped between those salt crystals absorbed many neutrons during the early weeks of the flood. Later, some of those salt deposits (including their trapped waters) were swept up to the Earth's surface as thick deposits or rose from the “mother salt layer” as salt domes. Therefore, water in and near thick salt deposits is rich in ^{18}O .



PREDICTION 52: Comets will be found to be rich in ^{18}O .

- **44. CE:** Presumably, ^{18}O was produced before the Earth evolved. But why ^{18}O is concentrated around large salt deposits is unknown (if the measurements are correct).

Lineaments. How did lineaments form?

- **45. HP:** Because rocks are weak in tension, fluttering hydroplates sometimes cracked along their convex surfaces when they arched up. This is why lineaments are generally straight cracks, dozens of miles long, parallel to a few directions, found all over the Earth, and show no slippage along the cracks. (Faults show slippage.) Powerful stresses probably converted some long, deep lineaments into faults that produce earthquakes.

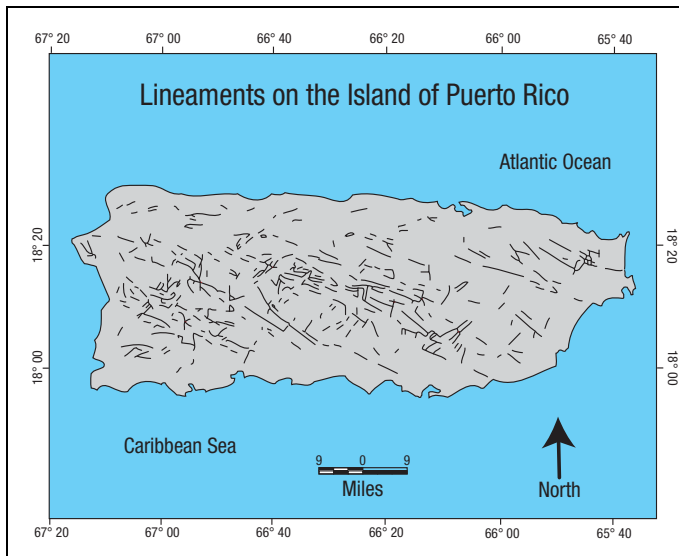

Figure 220: Lineaments. Lineaments are virtually impossible to detect from the ground, because they usually have no vertical or horizontal offsets. On Puerto Rico, the U.S. Geological Survey detected lineament segments (shown as thin black lines) using computer-processed data from side-looking airborne radar, flown 5 miles above the ground. Radar reflections from rock fractures were then digitized and processed by computers that “connected the dots.” The 636 lineaments identified were up to 15 miles in length. The absence of lineaments near coastlines is attributed to thick deposits of recent sediments that scattered the radar signals.¹⁴⁶



PREDICTION 53: A positive correlation will be found between lineament concentrations and earthquakes.

- ⊗ **46. CE:** While we can't be sure what produced lineaments, two possibilities have been discussed.

*We may speculate about their [lineament] origins. One widely suggested hypothesis is that they reflect continuing flexure of the crust in response to the tidal cycles. ... Another view is that the fractures may stem from subtle back-and-forth tectonic tilting of the crust as it responds to gentle upwarping and downwarping on a regional basis, although the cycles of back-and-forth tilting would necessarily be vastly longer than the twice-daily cycle of the tides.*¹⁴⁷

[Response: No one has observed rocks breaking because of tides or back-and-forth tilting.]

Cold Mars. The Mars Reconnaissance Orbiter has shown that the Martian polar crust is so rigid that seasonally shifting loads of ice at the poles produce little flexure. This implies that Mars' interior is extremely cold and has experienced surprisingly little radioactive decay.¹⁴⁸ (The evidence explained in “Mountains of Venus” on page 31 shows that the interior of Venus is also cold.)

- **47. HP:** The inner Earth is hot, because the flood produced large-scale movements, frictional heating, electrical activity, and radioactivity within the Earth.

Similar events never happened on Mars or Venus, so the interiors of Mars and Venus should be colder.

- **48. CE:** The solar system formed from a swirling dust cloud containing heavy radioisotopes billions of years ago. Therefore, with further measurements, Mars' interior will be shown to be hot, similar to Earth's.

Distant Chemical Elements. Stars and galaxies 12.9 billion light-years away contain chemical elements heavier than hydrogen, helium, lithium—and nickel. If those elements evolved, it must have happened within 0.8-billion years after the big bang (13.8-billion years ago) in order for their light to reach us. This is extremely fast, based on the steps required for chemical evolution. [See “How Old Do Evolutionists Say the Universe Is?” on page 461.]

- **49. HP:** Almost all chemical elements were created at the beginning, not just hydrogen, helium, and lithium. [See “Heavy Elements” on page 34.]

- **50. CE:** If the first stars to evolve were somehow extremely large, they would have exploded as supernovas in only a few tens of millions of years. That debris could then have formed second-generation stars containing these heavier chemical elements—all within 0.8-billion years. This would allow the 12.9-billion years needed for their light to reach us.

The Salt-Oil Connection. Why are massive salt deposits often found near large oil fields? Why is Brazil's Tupi oil field below 6,600 feet of salt and 4.8 miles below the surface of the Atlantic Ocean? How did the Gulf of Mexico and Mediterranean form?

- **51. HP:** See “Oil—and Mountains of Salt—All in the Right Places” on page 396, and Figure 217 on page 397.
- ⊗ **52. CE:** Many unusual things could happen over billions of years. The massive layers of salt under the floors of the Gulf of Mexico and Mediterranean Sea may indicate that those bodies of water evaporated after they were cut off from the Atlantic Ocean.

[Response: If that happened, it would have to be repeated 8–10 times to produce the thick salt layers that are under those sea floors. Highly unlikely! But even if all that evaporation occurred 8–10 times, why didn't each refilling dissolve the precipitated salt and wash it into the Atlantic Ocean? See Endnote 31 on page 142.]

Rising Himalayas. How were sediments mixed so uniformly and steadily (over 3,200,000,000 years) in a 1,250-mile-wide band (thousands of feet thick) at the southwestern base of the Himalayas?

- **53. HP:** Toward the end of the flood, the compression event pushed up the Himalayas in hours. The overlying flood waters rushed off the rising peaks in all directions, carrying well-mixed, deeply-eroded sediments. In that

Rising Himalayas

Near the end of the flood, the compression event suddenly uplifted major mountains, including the Himalayas (today's tallest and most massive mountain range). That forced overlying flood waters to spill away from the rising peaks and down the flanks of the Himalayas. Massive amounts of sediments were carried with those violent waters and deposited in 1,000-foot-thick layers at the base of the new mountain range.

The eroded sediments contained *zircons*, tiny crystals containing uranium and its decay products. Therefore, zircons can be radiometrically dated. Typically 60 or more zircons were dated at each of eleven locations spanning at least 2,000 kilometers (1,250 miles) at the base of the Himalayas. The ages (based on evolutionary assumptions) ranged from 300,000,000–3,500,000,000 years! Surprisingly, the distributions of ages at all eleven locations were statistically identical, showing that these sediments came from the same source.

Geologists have concluded that “well-mixed sediments were dispersed across at least 2,000 km of the northern Indian margin”¹⁴⁹ at the base of the Himalayas. Those geologists are mystified by how those sediments were mixed, transported, and deposited so uniformly over such large distances, and how all that extraordinary activity could have gone on, starting 3,200,000,000 years ago.

Some of the deepest and steepest gorges in the world dissect the Himalayan Mountains. A major study of one of these, the Yarlung Gorge, possibly the most spectacular gorge on Earth, showed that it formed not by slow river erosion, but by the extremely rapid uplift of the Himalayas. The authors of this study admit that “how and when this happened remains elusive.”¹⁵⁰



Figure 221: Little Girl, Big Mountain. As my granddaughter, Lily, springs up from the bottom of the pool, the waters rushing off her demonstrate how the flood waters surged radially away from the rapidly rising Himalayas. Sediments and fossilized *sea-bottom creatures* were swept off the rising peaks and deposited around the base of the Himalayas.

Geologists are dismayed at learning that sediments (thousands of feet thick) at the base of the Himalayas and spread over horizontal distances of at least 1,250 miles, *all came from the same source*. But their befuddlement will remain until they realize that today's major mountain ranges were pushed up suddenly from under the flood waters during the compression event. Of course, those geologists must also understand other aspects of the flood, including the origin of Earth's radioactivity.

If you reread the italicized paragraph above, you will begin to see how all this happened. Also, the wide range of “ages” has nothing to do with time, but reflects differing

brief time, the compression event and the resulting electrical activity produced the radioactive decay products that some erroneously believe have always been produced at today's extremely slow rate.

- ⊗ **54. CE:** “Well-mixed sediments were dispersed across at least 2000 km [1,250 miles] of the northern Indian margin. ... The great distances of sediment transport and high degree of mixing of detrital zircon ages are extraordinary, and they may be attributed to a combination of widespread orogenesis associated with the assembly of Gondwana, the equatorial position of continents, potent chemical weathering, and sediment dispersal across a nonvegetated landscape.”¹⁴⁹

[Response: This explanation may sound scientific, but is vague and speculative. Furthermore, such “extraordinary” mixing could not have gone on for 3.2-billion years—a vast age based on evolutionary assumptions.]

Forming Heavy Nuclei. *How do nuclei merge?*

- **55. HP:** Both shock collapse and the Z-pinch produce extreme compression in plasmas that can overcome the repelling (Coulomb) forces of other nuclei. When two nuclei are close enough, the strong force pulls them together. If the merged nucleus is not at the bottom of the valley of stability, it will decay or fission.

It is a mistake to think that fusion requires high temperatures ($>10^8$ K) for long times over large, stellarlike volumes. As the Ukrainian experiments have shown, with small amounts of energy, significant fusion (and fission) can occur in 10^{-8} second with a self-focused (Z-pinch) electron beam in a high-density plasma.¹¹⁶

- ⊗ **56. CE:** Supernovas provide the high temperatures and velocities needed for lighter nuclei to penetrate

Coulomb barriers. Those temperatures must be hundreds of times greater than temperatures inside stars, so most chemical elements (those heavier than 60 AMU) cannot form on Earth or inside stable stars.

In 1957, E. Margaret Burbidge, Geoffrey R. Burbidge, William A. Fowler, and Fred Hoyle published a famous paper in which they proposed how supernovas produce all the heavy chemical elements between iron and uranium.¹⁵¹

[Response: See the bolded “Response” on page 400.]

Many supernovas have been seen with powerful telescopes and instruments that can identify the elements and isotopes actually produced. So many elements and isotopes are missing that the supernova explanation must be reexamined.¹¹⁴

⁶Li, ⁹Be, ¹⁰B, and ¹¹B. Why do we have these light, fragile isotopes on Earth if small impacts will fragment them?

- **57. HP:** Light, fragile isotopes are too fragile to be created by impacts at the atomic level. Either they were created at the beginning or were produced by extreme compression (shock collapse and the Z-pinch).

Yes, in gases and plasmas, high temperatures produce high particle velocities which might allow nuclei to penetrate the Coulomb barrier. However, if those velocities are slightly larger than necessary, impacted ⁶Li, ⁹Be, ¹⁰B, and ¹¹B nuclei will fragment. Therefore, high temperatures, instead of fusing those nuclei together, will destroy them.²³

- **58. CE:** Some ⁶Li, ⁹Be, ¹⁰B, and ¹¹B might be explained by interstellar cosmic rays colliding with carbon, nitrogen, and oxygen, producing ⁶Li, ⁹Be, ¹⁰B, and ¹¹B fragments.

[Response: Studies of the abundances of these elements and isotopes in stars are inconsistent with this means of producing ⁶Li, ⁹Be, ¹⁰B, and ¹¹B.¹⁵²]

The following items pertain primarily to one theory.

Earthquakes and Electricity. Why does electrical activity frequently accompany large earthquakes?

- **59. HP:** During earthquakes, the piezoelectric effect and stresses within the vibrating crust can generate powerful electrical fields and discharges. For example, see at

<https://www.youtube.com/watch?v=sXA3kUef21M>

how the night sky lit up in rapidly changing colors during the 8.1 magnitude earthquake that hit southern Mexico on 8 September 2017. Notice the *changing* colors: blue, purple, and green—a clear sign that unusually powerful and changing voltages were released. Normal lightning is produced by a gradual voltage buildup in clouds.

Once air’s break-down voltage is reached (only about 1,000 volts per inch), yellow/white lightning is discharged.

During earthquakes, cyclic piezoelectric stresses in the massive crust act *over a broad area* and produce extreme voltages over that broad area that simultaneously strip electrons from the atomic nuclei comprising an equally broad area in the air *far above Earth’s surface*.

Therefore, free electrons accelerating toward those stripped nuclei along millions of paths have much greater energies, and emit more energetic colors that are farther from the low-energy (red/yellow) end of the color spectrum and more toward the high-energy (blue/green/violet) end of the spectrum.

Pegmatites. How do pegmatites form?

- **60. HP:** Before the flood, SCW dissolved granite’s more soluble components, such as quartz and feldspars, giving the lower crust a spongelike texture. During the compression event, high-pressure fluids that had filled those spongelike voids were injected up into fractures in the Earth’s crust. As the hydrothermal fluids rose, their pressures and temperatures dropped, so quartz and feldspars came out of solution and sometimes grew large crystals called *pegmatites*. This also explains the origin of most mineral-rich, hydrothermal fluids and most of Earth’s ore bodies.

Batholiths. How did batholiths form?

- **61. HP:** Batholiths were pushed up during the compression event. They cooled rapidly because the water that filled channels and pore spaces rapidly escaped and evaporated. Batholiths were never completely molten.

As the granite pushed up into and displaced the water-saturated sedimentary layers above, liquefaction again occurred, but on a regional scale. The reliquified sediments flowed off and stratified again in generally horizontal layers. [See “**Liquefaction: The Origin of Strata and Layered Fossils**” on pages 195–213.] This solves “the room problem” which has perplexed geologists for at least a century.⁷⁹

Radioactive Moon Rocks. Why were radioactive rocks found on the Moon’s surface?

- **62. HP:** From the Moon’s surface, astronauts brought back loose rocks containing hard, durable zircons. They contained 3.8-billion-years’ worth of radioactive decay products, *based on today’s decay rates*. The hydroplate theory postulates the rapid production of radioisotopes only on the Earth, not the Moon (or Mars). So why are radioactive rocks on the Moon?

As the flood began, the fountains of the great deep launched rocky debris containing those newly formed,

but radiometrically “old,” zircons. Much of that debris came from the crushed subterranean pillars in which many radioisotopes quickly formed. The Moon’s craters, lava flows, and some loose surface rocks are a result of bombardment by material ejected from Earth at high velocities. [See [Figure 175 on page 311](#).]

NASA’s Lunar Prospector, in a low polar orbit of the Moon from January 1998 to July 1999, detected alpha particles emitted by the decay products of ^{222}Rn , which itself is a decay product of ^{238}U . They were emitted from the vicinity of craters Aristarchus and Kepler which are located on the leading edge of the near side of the Moon, the most likely impact locations for debris launched by the fountains of the great deep.¹⁵³ [See [“The Debris When It Arrived at the Moon” on page 588](#).]



PREDICTION 54: Corings into *basement rock* on the Moon, Mars, or other rocky planets will find little radioactivity and fewer distinct isotopes than are on Earth.

Inconsistent Dates. Why are so many radiometric dates inconsistent with each other and with fossil correlations?

- ⊗ **63. CE:** Radiometric dating is unfortunately subject to contamination and millions of years of unknown conditions. However, even if our dates are off by a factor of ten, the Earth is not less than 10,000 years old.

[Response: The public has been greatly misled concerning the consistency and trustworthiness of radiometric dating techniques (such as the potassium-argon method, the rubidium-strontium method, and the uranium-thorium-lead method). For example, geologists hardly ever subject their radiometric age measurements to “blind tests.”¹⁵⁴ In science, such tests are a standard procedure for overcoming experimenter bias. Many published radiometric dates can be checked by comparisons with the evolution-based ages for fossils that sometimes lie above or below radiometrically dated rock. In more than 400 of these published checks (about half of those sampled), the radiometrically determined ages were at least one geologic age in error—indicating major errors in methodology and understanding.¹⁵⁵ One wonders how many other dating checks were not even published because they, too, were in error.]

Baffin Island Rocks. Are some Baffin Island rocks as old as the Earth?

- ⊗ **64. CE:** According to various evolutionary dating techniques, the oldest rocks in the world have been recently found on Canada’s Baffin Island. And yet, those rocks contain strange anomalies.¹⁵⁶ They have the highest ratios ever found (on Earth or in space) of $^3\text{He}/^4\text{He}$, long considered a measure of age, because the ^3He remains from the material that originally formed

the Earth. However, ^3He in surface rocks should have escaped into the atmosphere long ago or have been subducted into the mantle, where mantle convection would have largely mixed all helium isotopes.

Also, Baffin Island rocks have been dated by uranium-to-lead and other evolutionary dating techniques that give ages as old as the Earth itself! If they had been at the Earth’s surface for long, they would have been severely altered by erosion and weathering, but if they came from the mantle or below, they should have melted and been uniformly mixed.

[Response: Today, ^3He is produced only by nuclear reactions. Agafonov et al. have duplicated in the laboratory reported occurrences of lightning discharges that produce ^3He by nuclear fusion.¹

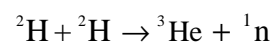

Therefore, the electrical discharges and resulting fusion reactions during the flood probably produced the large amounts of ^3He near Baffin Island.]

Chemistry in the Sun. Is the Sun a third-generation star?

- **65. CE:** The Sun contains heavy chemical elements, so evolutionists believe the Sun is at least a third-generation star. That is, the chemical elements in it and the solar system that are heavier than iron, such as gold and uranium, came from material spewed out by a supernova of a second-generation star that formed from earlier stars that exploded. This is *ad hoc* (a hypothesis, without independent support, created to explain away facts).

Chemistry in Stars. Why are stars so chemically different?

- **66. CE:** If all the heavier chemical elements came from debris made in stars and by supernovas, stars that formed from that debris should have similar ratios of these heavier elements. For example, a star named HE0107–5240, which has 1/200,000 of the iron concentration of the Sun, should have a similar concentration of the other heavier chemical elements relative to the Sun. Instead, HE0107–5240 has 10,000 times more carbon and 200 times more nitrogen than expected.¹⁵⁷ Such problems can be solved only by making new assumptions for which there is no supporting evidence.

Star and Galaxy Formation. How did stars and galaxies form? According to the chemical evolution theory, their formation is a prerequisite for producing radioactivity and 98% of the chemical elements.

- ⊗ **67. CE:** Let’s assume the big bang happened and all the heavier chemical elements and radioisotopes were made in stars and supernovas. A huge problem remains: mechanisms to form galaxies, stars (including our

The So-Called Tungsten Problem

Those who do not understand the origin of Earth's radioactivity are puzzled by what can be called the tungsten problem. Here is their dilemma:

"Some modern flood basalts have unusually high concentrations of tungsten-182 [^{182}W]. That is significant because that isotope forms only from radioactive decay of hafnium-182 [^{182}Hf]. And ^{182}Hf [which has a relatively short half-life of 9-million years] only existed during Earth's first 50-million years. 'These isotopes had to be created early,' says Rizo, of the University of Quebec in Montreal."¹⁵⁸

Since ^{182}W is produced only in this reaction

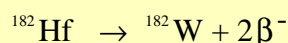

hafnium-182 must have been present either (1) at Earth's beginning, or (2) when radioactivity began. Which is it?

^{182}Hf is not a decay product today, so where did it come from? Not in the theorized big bang, because with such a short half-life, all ^{182}Hf would have decayed in 50-million years, long before they say the first star formed, much less the Earth. Besides, a big bang would only produce hydrogen, helium, and traces of lithium. So they conclude ^{182}Hf was produced much later in a supernova explosion. But again, ^{182}Hf could not have lasted for the vast time after that explosion until the Earth began to form. This is why Hanika Rizo stated (in the quote above) that ^{182}Hf had to be deposited early, in the Earth's first 50-million years. But, she never explains how that could happen.¹⁵⁹

Let's be generous, and assume that enough ^{182}Hf was somehow incorporated into the very early Earth. If Earth evolved (grew in size over billions of years), any ^{182}W produced that early would today be near the center of the Earth. We should never see it at the Earth's surface. But we do! More than 26% of all tungsten is ^{182}W , which is stable. Therefore, those who have this "tungsten problem" must argue that a plume carried ^{182}W up from the Earth's core to Earth's surface, through almost 2,000 miles of what they believe was circulating (convecting) mantle! That also will not work, because a circulating mantle would dilute the tungsten.¹⁶⁰ Besides, magma does not rise below the crossover depth (220 miles below the Earth's surface). Scientists give other reasons plumes cannot rise from the core to the Earth's surface. [See "Flood Basalts" on pages 166–167.]

So how did all that ^{182}W arrive at the Earth's surface? It was produced *at the Earth's surface* during the flood—in the fluttering crust and during the compression event by the "Self-Focusing Z-Pinch" as explained on page 393. For those who understand the flood and the origin of

Sun), and the Earth are unknown or are contradicted by undisputed observations. [See pages 27–36.]

Big Bang: Foundation for Chemical Evolution. *How sound is the big bang—the foundation for the chemical evolution theory?*

- ✘ 68. CE: The big bang theory is extremely flawed. [See "Big Bang?" and "Dark Thoughts" beginning on page 32.] A better explanation for the expansion of the universe is found on pages 439–453, "Why Is the Universe Expanding?" Cosmic microwave background radiation, discovered in 1965 and a main argument used to support the big bang, is better explained on pages 460–461.

Also, the high concentrations of deuterium found on the Earth—and especially in comets—resulted not from the big bang, but from neutron capture by water during the early weeks of the flood.⁸⁹ The widely taught beliefs concerning deuterium (as given from the chemical evolution perspective in the sidebar on page 400) may be wrong. A big bang would have probably consumed all the deuterium it ever produced, because deuterium is "burned" faster than it is produced. As advocates of chemical evolution and the big bang have admitted:

The net result of attempts to synthesize deuterium in the Big Bang remains distressingly inconclusive.¹⁶¹

The abundance of deuterium, in particular, is too high to be explained by stellar or cosmic ray processes. Deuterium is consumed more easily than it is produced, and, if cosmic rays were the source of deuterium, they would have also produced much more than the observed amount of ^7Li .¹⁶²

Final Thoughts

Notice the many disciplines involved in understanding the origin of Earth's radioactivity: chemistry, physics, nuclear physics, meteorology, astronomy, cosmology, mineralogy, geology, and engineering (mechanical, nuclear, and electrical). The hydroplate theory draws on evidence from even more fields in solving the other 25 major mysteries it addresses. [See page 111.]

Nature is not divided into academic disciplines. If we stay within our comfort zones and consider only topics in our favored disciplines (or, worse yet, only a few topics within a single discipline), we will miss the big picture and not be able to "connect the dots." We would be like the proverbial blind men trying to describe an elephant; disagreements would abound. This may partially explain why the global flood and its profound consequences have been overlooked for so long and why so few of us fully examine the complete subject scientifically.

No doubt, the almost unimaginable size and power of the flood also account for our past failure to understand the flood and its many consequences—such as Earth's radioactivity. We all tend to limit our thinking to familiar events, so it is a challenge to grasp the magnitude of the events unleashed when all the fountains of the great deep erupted and to recognize that the entire Earth's crust was once a gigantic nuclear reactor. Reprocessing all available evidence and various proposed explanations will take time, but we should attempt to follow the evidence.

Earth's Age. If you ask a hundred adults “How old is the Earth?”, you will probably hear ninety-nine *scientifically* shallow answers. On the old-Earth side, some will say, “Scientists say it is billions of years old,” “Radiometric dating shows that it is billions of years old,” or “I learned in school (or hear every week in the media) that it is millions of years old.” Only opinions of others are given. This is how science was practiced for thousands of years before Newton, Galileo, Kepler and the era of modern science; one simply quoted the opinions of supposedly “learned men,” such as Aristotle. If science still worked that way, technological advancements during the last 500 years would have been much slower. All of us might still believe the Earth is flat, because at one time the “learned men” said the Earth was flat.

On the young Earth side, you will sometimes see a listing of the many dating techniques that support a young Earth, such as those on pages 39–43, or hear criticisms (accurate and inaccurate) of radiometric dating. *Criticisms are not explanations.* Some who think that the Earth is young, base their belief on the Bible, but if their view is stated publicly, it usually draws scoffing by those who have heard all their lives that the Earth is old and honestly believe that is the scientific view. Many who believe in a young Earth become intimidated and avoid the subject. Also, in academic communities or in groups where political correctness is valued, young-Earth views usually produce embarrassed silence.

A Scientific Revolution. Widespread belief systems seldom change when frequently reinforced by influential institutions, such as the universities, media, religious institutions, and the scientific and intellectual elite. But when vast numbers of people realize that they have been misled, an intellectual revolution begins. Such a revolution in thinking occurred when Copernicus and Galileo showed that the Earth and other planets orbited the Sun. An equally significant transformation is occurring as more and more people realize that a global flood occurred and profoundly altered the Earth. Again, entrenched interests and fixed opinions will resist this shift in thinking. Observers of this revolution should note which side avoids a rational, scientific debate.

So how can this subject be discussed scientifically?

- We must focus on scientific evidence—that *which has been measured with instruments or detected with our senses, is verifiable, and bears on the issue.*
- Possible explanations cannot be ruled out ahead of time. For example, the flood and all its consequences should not be dismissed unless one is prepared to first address the scientific case. [See Part II of this book, including all twenty-five topics listed on page 111.]
- “The age of the Earth” and “the origin of Earth's radioactivity” need to be discussed openly, before all who are interested and understand the science. (Feeling strongly about the subject is not sufficient.) This chapter and the hydroplate theory provide starting points for that discussion.

Page 571 is my offer to those who reject a global flood, believe in an old Earth, and wish to participate in that open discussion. See if you, the reader, can flush out someone who will present scientific evidence opposing the global flood.

The assistance of Jon Schoenfield in writing this chapter has been invaluable and is greatly appreciated.

References and Notes

1. “The discovery that thunderstorms can trigger nuclear reactions provides insight into the physics of atmospheric electricity and unveils a previously unknown natural source of radioactive isotopes on Earth.” Leonid Babich, “Thunderous Nuclear Reactions,” *Nature*, Vol. 551, 23 November 2017, p. 443.

Those who have read this chapter since it was written in 2009 know that this source of radioactivity has been known and explained since 2009—it was not “previously unknown” in 2017, as quoted above. In fact, piezoelectric activity during the flood is the source of all of Earth's radioactivity.

- ◆ *Immediately after lightning crackled through the atmosphere, the detectors would register a burst of gamma rays, followed about 15 minutes later by an extended shower of gamma rays that peaked after 70 minutes and then tapered off with a distinctive 50-minute half-life.* Kim Krieger, “Lightning Strikes and Gammas Follow?” *Science*, Vol. 304, 2 April 2004, p. 43.

- ◆ *“It will be shown that the observations of near-ground AGR [atmospheric gamma radiation] following lightning are consistent with the production and subsequent decay of a combination of atmospheric radioisotopes [and new chemical elements] with 10–100 minute half-lives produced via nuclear reactions on the more abundant elements in the atmosphere.”* Mark B. Greenfield et al., “Near-Ground Detection of Atmospheric Rays Associated with Lightning” *Journal of Applied Physics*, Vol. 93, 1 February 2003, p. 1840.
- ◆ A.V. Agafonov et al., “Observation of Neutron Bursts Produced by Laboratory High-Voltage Atmospheric Discharge,” *Physical Review Letters*, Vol. 111, 12 September 2013, pp. 115003-1 – 115003-5.

These authors consider *nuclear fusion* as the likely mechanism for these bursts of neutrons. [Thanks to Rick Keane for calling these experiments to my attention on 5 December 2013.]

- In just 70 billionths of a second, 80 times more electrical current passes through the Z-pinch machine than is consumed in all the world during that same brief time interval. However, that energy is only enough to provide electricity to about five or six houses for an hour. Notice the *shortness* and *intensity* of a *linear discharge of electrical current*.

Similar experiments have been successfully conducted at Texas A & M University.

- While the physics of the process is well understood, several decades of engineering challenges must be solved before fusion reactors can become an economic reality.
- For more than a century, stresses in the Earth's crust have been known to produce powerful voltages and electrical surges. Since 1970, a common explanation for this has been the piezoelectric effect.

"In some parts of the world, earthquakes are often accompanied by ball lightning, stroke lightning and sheet lightning. ... We propose that the piezoelectric effect in the Earth's crust causes the electrical field. ... In rock with a mean piezoelectric coefficient several percent that of x cut single crystal quartz, and with typical seismic stress changes [of only] 30–300 bars, an earthquake makes an average electrical field of 500–5,000 V cm⁻¹. For distances of the order of half the seismic wavelength, the generated voltage is 5 × 10⁷ to 5 × 10⁸ V, which is comparable with the voltage responsible for lightning in storms." David Finkelstein and James Powell, "Earthquake Lightning," *Nature*, Vol. 228, 21 November 1970, p. 759.

Other mechanisms may also produce electrical effects from stressed rock, although a clear understanding of those mechanisms is lacking.

All past attempts to identify a physical process that could generate strong currents deep in the ground [by non-piezoelectric mechanisms] have not produced convincing results. Friedemann T. Freund et al., "Electric Currents Streaming Out of Stressed Igneous Rocks—a Step Towards Understanding Pre-Earthquake Low Frequency EM Emissions," *Physics and Chemistry of the Earth*, Vol. 31, 2006, p. 390.

Also, other minerals in the crust besides quartz may be piezoelectric. Nevertheless, it is undisputed that stresses in the Earth's crust will produce powerful voltages and electrical effects. Because the piezoelectric effect is easily explained, well understood, and quantifiable, it will be the mechanism described in this chapter.

- Briefer, but more intense, compressive stresses and electrical discharges also occurred as the hydroplates crashed near the end of the flood. Because this compression event may be harder to visualize, we will focus primarily on the broader and lengthier events at the beginning of the flood.
- "No complete theory exists which fully describes the structure and behavior of complex nuclei based solely on a knowledge of the force acting between nucleons [protons and neutrons]."* J. S. Lilley, *Nuclear Physics* (New York: John Wiley & Sons, Ltd, 2001), p. 35.

Various models of the atom are debated. Each explains some things, but each has problems. For example, the popular planetary model visualizes electrons orbiting a nucleus, much as planets orbit the Sun. However, a consequence of Ampere's Law and Faraday's Law is that a charged particle, such as an electron, moving in an orbit should radiate energy as electromagnetic waves. Electrons should lose energy and quickly fall into the nucleus. Stated another way:

The "planetary" model assumed that light, negatively charged electrons orbit a heavy, positively charged nucleus. The problem with this model was that the electrons would be constantly accelerating and should radiate energy as electromagnetic waves, causing the atom to collapse. Ibid., p. 4.

Because this does not happen, either electrons do not orbit nuclei, or the above laws must be modified.

Contrary to popular belief, atoms and their components (protons, neutrons, electrons, etc.) are not spheres or mathematical points. This is another example of how we sometimes unknowingly distort reality in order to simplify. Actually, the nuclei of some heavy elements are pear-shaped.

- Six of the 94 naturally occurring chemical elements have no stable isotopes. Four of the six—Technetium (**43**), Promethium (**61**), Astatine (**85**), and Francium (**87**)—are formed by cosmic rays and nuclear tests, but soon disappear. Two—Neptunium (**93**) and Plutonium (**94**)—are produced by the absorption of neutrons released by the fission of other isotopes. (*Atomic numbers*—the number of protons in the element's nucleus—are in blue italics above.) All elements above bismuth (**83**) are unstable and undergo radioactive decay. As of 2017, 118 elements have been observed, some very briefly in experiments.
- A few will raise some respectable objections. They say that stars, including our Sun, derive their energy by electrical and magnetic phenomena, not by fusing hydrogen into helium. [See Donald E. Scott, *The Electric Sky* (Portland, Oregon: Mikamar Publishing, 2006).] We will bypass this fascinating possibility, because the electrical explanation does not address the origin of Earth's radioactivity.
- When fusion merges two nuclei heavier than 60 AMU, energy is absorbed, *so cooling occurs*. The Proton-21 Electrodynamics Research Laboratory in the Ukraine is demonstrating this and is producing superheavy elements. [See [page 384](#).] Fluttering hydroplates at the beginning of the flood and the piezoelectric effect produced similar results. This origin of Earth's radioactivity also accounts for accelerated radioactive decay and corrects the false belief that the Earth is billions of years old.
- The instability index is an arbitrary formula that maps half-lives of 0 – ∞ years into an easily visualized 100–0 scale.

$$\left[\begin{array}{c} \text{instability} \\ \text{index} \end{array} \right] = \frac{100}{\pi/2} \tan^{-1} \left[\frac{C}{\text{half-life (yrs)}} \right]$$

where $C = 10^{-7}$ years. For example, a radioisotope with a half-life of 10^{-7} years (or 3 seconds) would have an instability

index of 50. That isotope would be represented by a tall, thin bar that rose halfway up the side of the valley of stability. The data used in constructing this figure were taken from *Nuclides and Isotopes: Chart of the Nuclides*, 16th edition (Schenectady, NY: Knolls Atomic Power Laboratory, 2002) by Edward M. Baum et al.

11. Why does the valley of stability curve? It is a direct result of “the strong force,” described briefly on page 382. For details, consult a good textbook on nuclear physics.
12. In decay, a nucleus is changed *spontaneously* (that is, by seemingly random processes inside the vibrating nucleus). Usually a tiny subatomic particle leaves (as in alpha, beta, or gamma decay) or enters (as in electron capture). In fission, a very large nucleus splits into two large nuclei. A wide range of products are possible. Fissions occur in two ways. Either the large nucleus splits after being bombarded by another particle, such as a neutron, or the nucleus splits spontaneously, without bombardment. Spontaneous fissions are considered decays, but most decays are not fissions. *Nor are decays nuclear reactions.* A nuclear reaction occurs when a nucleus is *changed by bombardment*. A Z-pinch is a type of nuclear reaction in which increasing magnetic forces squeeze two nuclei so close that the strong force merges them. Some isotopes, such as ^{238}U , can change in multiple ways: by alpha decay or by fissioning (spontaneously or by bombardment). When ^{238}U fissions spontaneously, it releases four times more energy than when it decays all the way to lead by emitting eight alpha particles and six beta particles. For ^{238}U , alpha decays are 1.8 million times more frequent than spontaneous fissions.
13. *“In addition to α particle decay, certain heavy mass nuclei have been observed to decay by emitting ^{12}C , ^{14}C , ^{20}O , ^{24}Ne , ^{28}Mg , or ^{32}Si at extremely low rates. This form of decay has been designated ‘Cluster Radioactivity,’ and was first observed in the emission of ^{14}C from ^{223}Ra . Since 1984, Cluster Radioactivity has been observed in 22 nuclides.”* Baum et al., p. 31.
 - ◆ H. J. Rose and G. A. Jones, “A New Kind of Natural Radioactivity,” *Nature*, Vol. 307, 19 January 1984, p. 245–247.
 - ◆ The isotopes that are now known to decay by emitting a carbon-14 nucleus (plus other particles) include: francium-221, radium-221, radium-222, radium-223, actinium-223, radium-224, actinium-225, and radium-226.
14. For example, hydrogen-6 has a half-life of 3×10^{-22} seconds, and tellurium-128 has the longest known half-life: 2.2×10^{24} years. Other isotopes may have more extreme decay rates, but their half-lives are more difficult to measure.
15. H. P. Hahn et al., “Survey on the Rate Perturbation of Nuclear Decay,” *Radiochimica Acta*, Vol. 23, 1976, pp. 23–37.

A few decay rates increase by 0.2% at a *static* pressure of about 2,000 atmospheres, the pressure existing 4.3 miles below the Earth’s surface. [See G. T. Emery, “Perturbation of Nuclear Decay Rates,” *Annual Review of Nuclear Science*, Vol. 22, 1972, pp. 165–202.]

In another static experiment, decay rates increased by 1.0% at pressures corresponding to 930-mile depths inside

the Earth. [See Lin-gun Liu and Chih-An Huh, “Effect of Pressure on the Decay Rate of ^7Be ,” *Earth and Planetary Science Letters*, Vol. 180, 2000, pp. 163–167.] Obviously, *static* pressures do not significantly accelerate radioactive decay.

16. K. Makariunas et al., “Effect of Chemical Structure on the Radioactive Decay Rate of ^{71}Ge ,” *Hyperfine Interactions*, Vol. 7, March 1979, pp. 201–205.
 - ◆ T. Ohtsuki et al., “Enhanced Electron-Capture Decay Rate of ^7Be Encapsulated in C_{60} Cages,” *Physical Review Letters*, Vol. 93, 10 September 2004, pp. 112501-1–112501-4.
17. Richard A. Kerr, “Tweaking the Clock of Radioactive Decay,” *Science*, Vol. 286, 29 October 1999, p. 882.
18. *“The rhenium-187 aeon [billion-year] clock is an example which brings to light—in a rather spectacular manner—the influence of the atomic charge state [electrical charge] on nuclear and astrophysical properties. It has long been recognized that the number and configuration of electrons bound in the atom can significantly alter beta decay lifetimes. However, none of these effects could be investigated until very recently, while only [electrically] neutral atoms were available in the laboratories.”* Fritz Bosch, “Setting a Cosmic Clock with Highly Charged Ions,” *Physica Scripta*, Vol. T80, 1999, p. 34.
 - ◆ *“... a half-life of 32.9 ± 2.0 yr for bare ^{187}Re nuclei could be determined, to be compared with 42 Gyr for neutral ^{187}Re atoms.”* Fritz Bosch et al., “Observation of Bound-State β^- Decay of Fully Ionized ^{187}Re ,” *Physical Review Letters*, Vol. 77, 23 December 1996, p. 5190.
19. *“Unexplained periodic fluctuations in the decay rates of ^{32}Si and ^{226}Ra have been reported by groups at Brookhaven National Laboratory (^{32}Si) and at the Physikalisch-Technische Bundesanstalt in Germany (^{226}Ra). We show from an analysis of the raw data in these experiments that the observed fluctuations are strongly correlated in time, not only with each other, but also with the distance between the Earth and the Sun.”* Jere H. Jenkins et al., “Evidence for Correlations Between Nuclear Decay Rates and Earth-Sun Distance,” arXiv:0808.3283v1 [astro-ph], 25 August 2008, p. 1.
 - ◆ Davide Castelvecchi, “Half-life (More or Less),” *Science News*, Vol. 174, 22 November 2008, pp. 20–22.
 - ◆ *“Proximity to the sun seemed to influence radioactivity, and violent activity on the sun could also increase or decrease decay rates.”* Corey S. Powell, “Beware: Superflare,” *Discover*, March 2013, p. 69.
20. Neutrinos are extremely light subatomic particles that travel at nearly the speed of light, carry no electrical charge, and have great ability to pass through matter (without harm). Trillions of neutrinos from the Sun pass harmlessly through each person on Earth every second!
21. See United States Patent 5076971, “Method for Enhancing Alpha Decay in Radioactive Materials,” awarded on 28 August 1989 to William A. Barker. Assignee: Altran Corporation (Sunnyvale, California).
22. Z-pinch (or a self-focusing plasma flow) occurs only if the current exceeds a critical threshold.

Streams of fast electrons which can accumulate positive ions in sufficient quantity to have a linear density of positives about equal to the linear density of electrons, along the stream, become magnetically self-focussing when the current exceeds a value which can be calculated from the initial stream conditions.

Willard H. Bennett, "Magnetically Self-Focussing Streams," *Physical Review*, Vol. 45, June 1934, p. 890.

That electrical current, according to Bennett [p. 896], turns out to be very small when the voltage is extremely large, as it would be for fluttering hydroplates. That current is

$$i = \frac{2.5 T}{10^3 \sqrt{V}}$$

where T is in kelvins and V is in volts. If the plasma's temperature, T, is 10,000 K and the voltage, V, is $40,000 \times 10^6$ volts (as explained in Figure 222), then the current required for a Z-pinch is 0.0001 amp—a trivial amount.

With such high voltages, electron velocities become relativistic (become a large fraction of the speed of light). Indeed, One of the key components in the Ukrainian experiments is a relativistic electron beam.

23. "... the nuclei of elements Li, Be, and B are easily destroyed in thermonuclear reactions due to the insufficiently high binding energy." Adamenko et al., p. 458.
- ◆ "Specifically, the rare and fragile light nuclei Lithium, Beryllium and Boron are not generated in the normal course of stellar nucleosynthesis (except ${}^7\text{Li}$) and are, in fact, destroyed in stellar interiors." E. Vangioni-Flam and M. Cassé, "Cosmic Lithium-Beryllium-Boron Story," *Astrophysics and Space Science*, Vol. 265, 1999, p. 77.
 - ◆ "Thus the net result is always to convert these elements [deuterium, Li, Be, and B] into helium through proton bombardment, and the rates of the reactions are such that in all conditions before a star evolves off the main sequence all of the deuterium, lithium, beryllium, and boron in the volume which contains the vast majority of the mass will be destroyed." E. Margaret Burbidge et al., "Synthesis of the Elements in Stars," *Reviews of Modern Physics*, Vol. 29, October 1957, p. 618.
24. One might wonder how a star composed of only neutrons could exist if neutrons must be surrounded by protons and electrons to be stable. Yes, neutrons at the surface of a neutron star will tend to decay into a proton, electron, and an antineutrino, but the extreme gravity of a neutron star would probably prevent electrons from permanently escaping from neutrons. [See Lloyd Earnest Busch, "The Paradox of Neutron Decay in Neutron Stars," *Journal of Theoretics*, Vol. 5, No. 2, 2003, pp. 10–11.]
25. Paul Giem, "Carbon-14 Content of Fossil Carbon," *Origins*, Vol. 51, 2001, pp. 6–30.
- ◆ John R. Baumgardner et al., "Measurable ${}^{14}\text{C}$ in Fossilized Organic Materials," *Proceedings of the Fifth International Conference on Creationism* (Pittsburgh, Pennsylvania: Creation Science Fellowship, Inc., 2003), pp. 127–142.
26. Melvin A. Cook, *Prehistory and Earth Models* (London: Max Parrish, 1966), pp. 66–67.
27. "The K-Ar method, which is based on the decay of ${}^{40}\text{K}$ to ${}^{40}\text{Ar}$, is probably the most commonly used radiometric dating technique available to geologists." G. Brent Dalrymple, *The Age of the Earth* (Stanford, California: Stanford University Press, 1991), p. 90.
28. "This amount of ${}^{40}\text{Ar}$ is greater by three orders of magnitude than would be expected for a chondritic abundance of potassium in Enceladus' rock fraction, thus requiring both an efficient mechanism for the escape of ${}^{40}\text{Ar}$ from the rock component and a mechanism for concentrating it." J. H. Waite Jr. et al., "Liquid Water on Enceladus from Observations of Ammonia and ${}^{40}\text{Ar}$ in the Plume," *Nature*, Vol. 460, 23 July 2009, p. 488.
29. "The D/H ratio [on Enceladus] is close to the cometary value of 3×10^{-4} , nearly twice the terrestrial ocean water value (1.56×10^{-4}), and more than ten times the value of the D/H ratio in the protosolar nebula (2.1×10^{-5})." Ibid.
30. Cook, pp. 66–67.
- ◆ "... almost all of the ${}^{40}\text{Ar}$ and ${}^4\text{He}$ were produced in the Earth." Frank D. Stacey, *Physics of the Earth*, 3rd edition (Brisbane, Australia: Brookfield Press, 1992), p. 63.
31. Stanislav Adamenko et al., *Controlled Nucleosynthesis: Breakthroughs in Experiment and Theory* (Dordrecht, The Netherlands, Springer Verlag, 2007), pp. 1–773.
- Those who wish to critically study the claims of Adamenko and his laboratory should carefully examine the evidence detailed in his book. One review of the book can be found at www.newenergytimes.com/v2/books/Reviews/AdamenkoByDolan.pdf
- ◆ "We present results of experiments using a pulsed power facility to induce collective nuclear interactions producing stable nuclei of virtually every element in the periodic table." Stanislav Adamenko et al., "Exploring New Frontiers in the Pulsed Power Laboratory: Recent Progress," *Results in Physics*, Vol. 5, 2015, p. 62.
32. "The products released from the central area of the target [that was] destroyed by an extremely powerful explosion from inside in every case of the successful operation of the coherent beam driver created in the Electrodynamics Laboratory 'Proton-21,' with the total energy reserve of 100 to 300 J, contain significant quantities (the integral quantity being up to 10^{-4} g and more) of all known chemical elements, including the rarest ones." [emphasis in original] Adamenko et al., p. 49.
- In other words, an extremely powerful, but tiny, Z-pinch-induced explosion occurred inside various targets, each consisting of a single chemical element. All experiments combined have produced at least 10^{-4} gram of every common chemical element.
- ◆ In these revolutionary experiments, the isotope ratios for a particular chemical element resembled those found today for natural isotopes. However, those ratios were different enough to show that they were not natural isotopes that somehow contaminated the electrode or experiment.

33. Stanislav Adamenko, "The New Fusion," *ExtraOrdinary Technology*, Vol. 4, October-December, 2006, p. 6.
34. "The number of formed superheavy nuclei increases when a target made of heavy atoms (e.g., Pb) is used. Most frequently superheavy nuclei with A=271, 272, 330, 341, 343, 394, 433 are found. The same superheavy nuclei were found in the same samples when repeated measurements were made at intervals of a few months." Adamenko et al., "Full-Range Nucleosynthesis in the Laboratory," *Infinite Energy*, Issue 54, 2004, p. 4.
35. "The energy of a coherent driver [the electron beam] is equal to only a small part of the total energy released in the process of transformation of nuclei of the target [electrode] into nuclei of the synthesized isotopes. In fact, in the zone of the self-organized collapse, we are faced with the process of a distinctive "cold repacking" of nucleons which initially belonged to nuclei of the target. This process terminates in the final configuration which corresponds to newly synthesized isotopes. ... the process is adiabatic." Ibid., p. 3.
36. Stanislav Adamenko, "Results of Experiments on Collective Nuclear Reactions in Superdense Substance," *Proton-21 Electrodynamics Laboratory*, 2004, pp. 1–26. For details see www.proton21.com.ua/articles/Booklet_en.pdf.
- ◆ "Frequently Asked Questions," *Proton-21 Electrodynamics Laboratory*. See: www.proton21.com.ua/faq_en.html.
 - ◆ Stanislav Adamenko, Personal communication, 13 April 2010.
37. "The first 700 million years of Earth's 4.5-billion-year existence are known as the Hadean period, after Hades, or, to shed the ancient Greek name, Hell. That name seemed to fit with the common perception that the young Earth was a hot, dry, desolate landscape interspersed with seas of magma and inhospitable for life." Kenneth Chang, *The New York Times*, 2 December 2008, p. D1.
38. Michelle Hopkins et al., "Low Heat Flow Inferred from >4 Gyr Zircons Suggest Hadean Plate Boundary Interactions," *Nature*, Vol. 456, 27 November 2008, pp. 493–496.
39. "The origin of the carbon and the nature of the carbon reservoir, as well as the process by which microdiamonds can be incorporated in zircon together with 'granitic' inclusions, present problems fundamental to understanding processes active in the early history of the Earth. ... The observed large variations in [carbon isotope ratios] inclusions hosted in the same zircon grain suggest that the carbon inclusions formed from different material and/or under different geological conditions before they were eventually included in the zircon. ... Therefore, the simplest explanation, and the one which is supported by most observations, is that the diamond formation must pre-date zircon crystallization and, most probably, is not related to zircon formation." Alexander A. Nemchin et al., "A Light Carbon Reservoir Recorded in Zircon-Hosted Diamond from the Jack Hills," *Nature*, Vol. 454, 3 July 2008, pp. 92–93.
40. "In fact, considering the Precambrian age of the granite cores [containing zircons], our results show an almost phenomenal amount of He has been retained at higher temperatures, and the reason for this certainly needs further investigation ..." Robert V. Gentry et al., "Differential Helium Retention in Zircons," *Geophysical Research Letters*, Vol. 9, October 1982, p. 1130.
- ◆ D. Russell Humphreys, "Young Helium Diffusion Age of Zircons Supports Accelerated Nuclear Decay," *Radioisotopes and the Age of the Earth*, editors Larry Vardiman et al. (El Cajon, California: Institute for Creation Research, 2005), pp. 25–100.
41. How is ^3H produced? Nuclear reactions first produce ^3H (tritium), either as a rare fission product, or in one of the following ways: (Remember free neutrons are rare and have a half-life of only 14.7 minutes.)
- $$^6\text{Li} + n \rightarrow \alpha + ^3\text{H}$$
- $$^{14}\text{N} + n \rightarrow ^{12}\text{C} + ^3\text{H}$$
- $$^{14}\text{N} + n \rightarrow 3\alpha + ^3\text{H}$$
- Then, a beta decay (with a half-life, today, of 12.32 years) converts ^3H into ^3He . [See L. T. Aldrich and Alfred O. Nier, "The Occurrence of He^3 in Natural Sources of Helium," *Physical Review*, Vol. 74, 1 December 1948, pp. 1590–1594.]
42. "But the questions of how gas from the solar nebula was trapped in the solid parts of growing planets, and how the gas was preserved through early accretionary events, will certainly test our models of accretion." Chris J. Ballentine, "A Dash of Deep Nebula on the Rocks," *Nature*, Vol. 486, 7 June 2012, p. 41.
43. "They found [in Siberian flood basalts] that the ratio of helium 3 to helium 4 was not just 8 times greater than the atmospheric ratio, as it is at midocean ridges, but 13 times greater." Marc Zabludoff, "Breakthroughs, Geology," *Discover*, Vol. 16, December 1995, p. 122.
- ◆ The ratio of ^3He to ^4He varies widely in rocks near oceanic trenches, among deposits of natural gas, and within the Hawaiian Islands.
44. "... the location or process that could prevent such a deep reservoir [of ^3He] from mixing into the convecting mantle and disappearing completely have remained enigmatic." Ballentine, p. 41.
45. H. S. Carslaw and J. C. Jaeger, *Conduction of Heat in Solids*, 2nd edition (Oxford: At the Clarendon Press, 1959), p. 87.
- ◆ R. J. Strutt (son of the famous Lord Rayleigh who made many scientific discoveries, including the discovery of argon) first explained this in 1906, ten years after Henri Becquerel discovered radioactivity. Strutt measured radioactivity in various rocks and found that granite contained more than enough radioactivity to explain all geothermal heat. He concluded that "Earth's radioactivity was confined to the crust, a few tens of kilometers thick." [See Stacey, *Physics of the Earth*, 3rd edition (1992), p. 45.]
 - ◆ Each year on average, radioactive decay releases W calories of heat per cubic centimeter of granite, and S calories of heat escape into the atmosphere from each square centimeter of continental (granitic) crust. A layer of granite only S/W thick would account for all this heat, if steady state has been reached. Here are some reported values of W and S:

Table 24. Radioactive Heat Production in Crust

Year	W	S	S/W	Reference
1959	17.0×10^{-6}	41.0	24.1 km	Carslaw and Jaeger, pp. 83, 86
1969	23.0×10^{-6}	45.1	19.6 km	Stacey, 1969, pp. 240, 245
1992	21.4×10^{-6}	44.3	20.7 km	Stacey, 1992, pp. 292, 300

As explained on pages 153–193, other heat sources are generating heat within the Earth, so these thicknesses of granite would be even thinner. The granite crust is generally estimated to be at least 50 km (30 miles) thick. Therefore, steady state has not been reached. In other words, radioactivity is concentrated in the crust but has not been there long enough to reach steady state.

- ◆ *“Surface rocks show traces of radioactive materials, and while the quantities thus found are very minute, the aggregate amount is sufficient, if scattered with this density throughout the earth, to supply, many times over, the present yearly loss of heat. In fact, so much heat could be developed in this way that it has been practically necessary to make the assumption that the radioactive materials are limited in occurrence to a surface shell only a few kilometers in thickness.”* Leonard R. Ingersoll et al., *Heat Conduction: With Engineering, Geological and Other Applications*, revised edition (Madison, Wisconsin: University of Wisconsin Press, 1954), p. 102.
 - ◆ *“Uranium, thorium and potassium are the main elements contributing to natural terrestrial radioactivity. ... All three of the radioactive elements are strongly partitioned into the continental crust.”* J. A. Plant and A. D. Saunders, “The Radioactive Earth,” *Radiation Protection Dosimetry*, Vol. 68, 1996, p. 25.
46. *“... the molten rock oozing from midocean ridges lacks much of the uranium, thorium, and other trace elements that spew from some aboveground volcanoes.”* Sid Perkins, “New Mantle Model Gets the Water Out,” *Science News*, Vol. 164, 13 September 2003, p. 174.
 47. *“... 90% of uranium and thorium are concentrated in the continents. In general, the heat production rate must decrease with depth. Otherwise, surface values would imply zero or negative mantle heat flow.”* Dan F. C. Pribnow, “Radiogenic Heat Production in the Upper Third of Continental Crust from KTB,” *Geophysical Research Letters*, Vol. 24, 1 February 1997, p. 349.

Continents contain much less than 1% of the Earth’s mass (actually 0.35%), so why do they have 90% of Earth’s uranium and thorium?

48. *“The measured temperature gradient of 27.5 K km^{-1} in the upper 9.1 km [5.7 miles] cannot continue to the Moho, otherwise a boundary condition derived from seismic interpretations is violated.”* Ibid., pp. 351–352.

In other words, the rocks directly below the Moho would have melted—an easily detected condition. Decades ago, students were taught that the mantle was a liquid. Even today, some textbooks make this erroneous claim. If the mantle had only a thin, *continuous* shell of liquid at any depth, certain seismic waves (shear waves, also called secondary waves)

could not pass through that shell. However, seismometers all over the world measure those waves daily.

49. Robert F. Roy et al., “Heat Generation of Plutonic Rocks and Continental Heat Flow Provinces,” *Earth and Planetary Science Letters*, Vol. 5, 1968, pp. 1–12.
50. For example, did you know that a person’s foot size correlates with writing ability? Does this mean that the bigger your feet, the better you write? No. It means that babies don’t write well.

Although correlations may suggest a cause and effect relationship, they do not demonstrate cause and effect. For that, mechanisms and experimental results are needed.
51. So far, 16 zones have been discovered; some are connected.
52. If 100 neutrons were somehow produced in the first generation, and x neutrons were produced in the second generation, the reactor’s efficiency would be x percent. If

$$k = \frac{x}{100}$$

the total number of neutrons produced would be

$$100 (1 + k^1 + k^2 + k^3 + \dots) = \frac{100}{1 - k} \quad \text{where } k < 1$$

If $k = 0.6$, a total of 250 neutrons would be produced for every 100 initial neutrons. With an efficiency of 99%, 10,000 neutrons would be produced. If a trillion neutrons were produced in the first generation, and the efficiency were 99%, a total of 100 trillion neutrons would be produced.

53. *“Reactors 7 to 9 [discovered in 1978] ... appear as small uranium-rich pockets where the core of the reactor is always very thin (a few centimeters) ...”* F. Gauthier-Lafaye et al., “Natural Fission Reactors in the Franceville Basin, Gabon: A Review of the Conditions and Results of a ‘Critical Event’ in a Geologic System,” *Geochimica et Cosmochimica Acta*, Vol. 60, No. 23, 1996, p. 4838.
54. *“The anomalous behavior at the reactor zone borders should be further investigated to determine if it is a general phenomenon capable of a common explanation such as the ‘reflux’ hypothesis presented in this paper.”* G. A. Cowan et al., “Some United States Studies of the Oklo Phenomenon,” *The Oklo Phenomenon* (Vienna: Vienna International Atomic Energy Agency, 1975), p. 355.

In a later paper, Cowan acknowledged that the “reflux hypothesis” did not explain the problem and that “puzzling anomalies” remained at the borders. [See George A. Cowan, “A Natural Fission Reactor,” *Scientific American*, Vol. 235, July 1976, p. 44.]
55. S. Hishita and A. Masuda, “Thousandfold Variation in $^{235}\text{U}/^{238}\text{U}$ Ratios Observed in a Uranium Sample from Oklo,” *Naturwissenschaften*, Vol. 74, May 1987, pp. 241–242.
56. A. A. Harms, “Reaction Dynamics and $^{235}\text{U}/^{238}\text{U}$ Ratios for the Oklo Phenomenon,” *Naturwissenschaften*, Vol. 75, January 1988, pp. 47–49.

57. William R. Corliss has cataloged many books and reports of electrical activity associated with earthquakes. My brief extracts, slightly edited, are taken from his *Strange Phenomena* (Glen Arm, Maryland: The Sourcebook Project, 1974), Vol. G1, pp. 183–204 and Vol. G2, pp. 135–151.
58. Myron L. Fuller, *The New Madrid Earthquake* (Washington, D.C.: USGS Bulletin 494, 1912), p. 46.
59. Radiohalos have been found in more than 40 minerals. [See Robert V. Gentry, “Radioactive Halos,” *Annual Review of Nuclear Science*, Vol. 23, 1973, p. 350.]
60. G. H. Henderson and F. W. Sparks, “A Quantitative Study of Pleochroic Halos, p. 243.
61. Actually, almost all (9,998 out of 10,000) ^{218}Po isotopes decay by emitting an alpha particle. A few emit a beta particle.
62. Robert V. Gentry, *Creation's Tiny Mystery*, 2nd edition (Knoxville, Tennessee: Earth Sciences Associates, 1988).
- Robert Gentry, in several dozen papers in leading scientific journals, has reported important discoveries concerning these mysteries. He may be the one person most responsible for showing that the Earth's crust was never molten and, therefore, did not evolve. The importance of Gentry's work is shown by the intensity of the opposition he has received; yet, many of his opponents admit in published writings that they cannot explain parentless polonium halos. To minimize that major problem, opponents often refer to this as “a tiny mystery.” No, only the halos are tiny; the mystery to evolutionists is great, and the dilemma this presents to those who believe in a 4.5-billion-year-old Earth is even greater.
63. If a billion polonium-218 (^{218}Po) atoms had ever been concentrated in a tiny inclusion in dry rock, the heat generated within one half-life (3.1 minutes) would melt an isolated sphere of radius 0.0033 cm. This is 40% larger than the final ^{218}Po halo radius of 0.0023 cm. Since polonium halos never melted, as explained in Endnote 64, we can conclude that a billion ^{218}Po atoms were never concentrated at any tiny inclusion in dry rock *at the same time. This includes the time of the rock's creation.* The actual melting would begin at the instant of creation ($t=0$) and rapidly advance outward from the center to a distance of 0.0033 cm in 3.1 minutes. Assume that a billion ^{218}Po atoms are concentrated in a tiny inclusion. Half would eject an alpha particle within 3.1 minutes—each alpha particle releasing 6.0 MeV of energy. (1 MeV = 3.83×10^{-14} cal) Of those 500,000,000 alpha particles, the first 375,000,000 would raise the sphere's temperature up to the rock's melting point. The remaining 125,000,000 alpha particles would melt the entire sphere.

To verify the above statements, the following properties of the rock will be used:

$$\text{density} = 2.7 \frac{\text{gm}}{\text{cm}^3} \quad \text{heat of fusion} = 71 \frac{\text{cal}}{\text{gm}}$$

$$\text{specific heat} = 0.21 \frac{\text{cal}}{\text{gm}^\circ\text{C}}$$

$$\left\{ \begin{array}{c} \text{melting} \\ \text{temperature} \end{array} \right\} - \left\{ \begin{array}{c} \text{ambient} \\ \text{temperature} \end{array} \right\} = 1000^\circ\text{C}$$

mass of a sphere with a radius of 0.0033 cm

$$= 2.7 \left[\frac{4\pi}{3} (0.0033)^3 \right] = 4.03 \times 10^{-7} \text{ gm}$$

and the following two heat-balance equations can be easily and quickly checked. First, raising the sphere's temperature to its melting point:

$$(3.75 \times 10^8) (6.0 \times 3.83 \times 10^{-14}) = 4.03 \times 10^{-7} \times 0.21 \times 1000$$

Then, melting the rock:

$$(1.25 \times 10^8) (6.0 \times 3.83 \times 10^{-14}) = 4.03 \times 10^{-7} \times 71$$

So why do we see *unmelted* polonium halos?

- i. Each ^{218}Po ion was electrically attracted within minutes to a tiny inclusion after it formed by the decay of ^{222}Rn . [See “**Rapid Attraction**” on page 607.] With trillions of ^{222}Rn atoms transported in the water flowing through the spongelike channels in the crust, and many ^{218}Po ions simultaneously moving toward their destination, this could have taken days or weeks, enough time for the heat to transfer away as the halo slowly formed.
- ii. The halos were cooled by considerable flowing subsurface water and by the “evaporation” of the volatile OH^- .

For details, see “**Isolated Polonium Halos**” on pages 406–408.

64. Gentry conducted tests that confirmed that melting did not occur. [See Robert V. Gentry, “Radiohalos in a Radiochronological and Cosmological Perspective,” *Science*, Vol. 184, 5 April 1974, pp. 62–66.]
65. Gentry never observed this concentration of halo centers in specific sheets. Personal communication, 7 August 2009.
66. Henderson and Sparks, “A Quantitative Study of Pleochroic Halos, IV,” *Proceedings of the Royal Society of London*, Series A, Vol. 173, 1939, pp. 238–249.
- ◆ G. H. Henderson, “A Quantitative Study of Pleochroic Halos, V,” *Proceedings of the Royal Society of London*, Series A, Vol. 173, 1939, pp. 250–263.
67. More specifically, the mine's intrusions were “*calcite vein dikes (rocks containing mostly the mineral calcite and other minerals, such as mica) that are small in length and width and cut metasedimentary rocks which still retain bedding planes.*” [See J. Richard Wakefield, “Gentry's Tiny Mystery,” *Creation/Evolution*, Vol. 22, Winter 1987–1988, p. 17.]

- ◆ Gentry discusses this trip on pages 325–327 of *Creation's Tiny Mystery*. Wakefield discusses it in the reference above.
- 68. "... the existence of polonium halos in the biotite at the Fission and Silver Crater Mines [near Bancroft, Ontario] serves to identify the host 'vein dikes' as also being created rocks, ..." Robert V. Gentry, "Response to Wise," *Creation Research Society Quarterly*, Vol. 25, March 1989, p. 177.
- ◆ "... [Wakefield] implies that certain 'intrusive,' crystalline rocks discount a creation origin for those rocks, but the fact is, my creation model includes these among the rock types that were created [as solids]." Robert V. Gentry, "Response to Wakefield's Remarks," *Creation's Tiny Mystery*, p. 325.
- 69. Kurt P. Wise, "Radioactive Halos: Geologic Concerns," *Creation Research Society Quarterly*, Vol. 25, March 1989, pp. 171–176.
- 70. Lorence G. Collins, "Polonium Halos and Myrmekite in Pegmatite and Granite," *Expanding Geospheres, Energy and Mass Transfers from Earth's Interior*, editor C. Warren Hunt (Calgary: Polar Publishing Company, 1992), p. 132.

Obviously, Collins overstates his case, because he could not have checked "*all of the granites in which Gentry found polonium halos.*" Nevertheless, myrmekites were found in many of those granites.

- 71. Feldspars are a class of minerals that constitute almost 60% of the Earth's crust. The subgroup, plagioclase feldspars, comes in two varieties: calcium-rich and sodium-rich. Myrmekite contains only the sodium variety. Sodium feldspars form when sodium (Na^{1+}) and silicon (Si^{4+}) replace calcium (Ca^{2+}) and aluminum (Al^{3+}) in calcium feldspars.

An alert reader may wonder (1) where all the calcium went, and (2) what provided the silicon for the replacement. The chapter "*The Origin of Limestone*" on pages 260–266 answers the first question. Pages 126–127, which explain the extreme solubility of quartz (SiO_2) in supercritical water (SCW), answer the second.

What accounts for the replacement of aluminum (Al) with sodium (Na) in the sodium feldspars? Answer: SCW readily dissolves aluminum (which opened up slots in calcium feldspars). Salt (NaCl) was dissolved in SCW as Na^+ and Cl^- . The Na^+ then entered those slots.

- 72. "... several 'puzzles' that still challenge the geologic profession: ... Why are Po halos in biotite and fluorite associated with myrmekite-bearing granites?" Lorence G. Collins, *Hydrothermal Differentiation and Myrmekite—A Clue to Many Geologic Puzzles* (Athens, Greece: Theophrastus Publications, S.A., 1988), p. 5.
- 73. "The Po halos are observed to occur primarily in biotite and fluorite in pegmatites and in biotite in granite in terranes where the granite is myrmekitic." *Ibid.*, p. 232.
- 74. "Thus, polonium was deposited in new crystals that grew from voluminous hydrothermal flushing of sheared and fractured, formerly-solid, mafic rock. ... Rapid entry of radon and precipitation of polonium could occur if a gabbro or diorite site were made porous and depressurized by

tectonism." Collins, "Polonium Halos and Myrmekite in Pegmatite and Granite," pp. 135, 136.

- ◆ Collins' explanation is a more detailed refinement of the explanation by Canadian physicist G. H. Henderson in 1939, one of the earliest radiohalo researchers. [See Endnote 60.] Others have proposed less-successful variations of Henderson's basic insight or have repackaged Collins' explanation without proper credit.
- 75. Collins' vague explanation lacks specifics and a mechanism. *The creeping rock-movements associated with seismically-active terranes open avenues for radon-bearing water to move into lower-pressured pore space, and to the surface.* Collins, "Polonium Halos and Myrmekite in Pegmatite and Granite," p. 134.
"Creeping"? Why "seismically-active"? Why was there so much "radon-bearing water"? The radon in question, ^{222}Rn , has a half-life of only 3.8 days. What "opened 'avenues' inside rock for radon-bearing water" and when? What provided the necessary energy and forces?
- 76. Photographs of these elliptical halos can be seen in Plate 5 of Gentry's Radiohalo Catalogue in *Creation's Tiny Mystery*.
- 77. Bryan C. Chakoumakos et al., "Alpha-Decay Induced Fracturing in Zircon: The Transition from the Crystalline to the Metamict State," *Science*, Vol. 236, 19 June 1987, pp. 1556–1559.
- 78. "Fractures pay not the least attention to the cohesion minimums and not even to grain boundaries, where slip would take place so easily under stresses, but evidently occur quite suddenly in the form of an explosive fracture and not a slow expansion. The evidently simultaneous effect on various other constituents including those of rather different hardness and tenacity are proof of the above. The sudden released energy must be enormous in individual cases. The author observed fracture circles about orthite in quartz of about 1 meter diameter in the Iveland district in southern Norway!" Paul A. Ramdohr, "New Observations on Radioactive Halos and Radioactive Fracturing," *Oak Ridge National Laboratory Translation* (ORNL-tr-755), 26 August 1965, p. 19.
- 79. "One of the major problems in determining the origin of batholiths of granite composition is to explain what happened to the country rock [the older rock] that was displaced by the invading magma." [See Arthur N. Strahler, *Physical Geology* (New York: Harper & Row, Publishers, 1981), p. 912.]
◆ "A second problem involves the great volume [hundreds of cubic miles in some cases] of pre-existing country rock which must be removed to provide space for an invading batholith—the eliminated country rock must be accounted for somehow." [See W. G. Ernst, *Earth Materials* (Los Angeles: Prentice-Hall, Inc., 1969), p. 108.]
- 80. A cyclic load on granite will temporarily produce a cyclic voltage. Normally, free electrons in the Earth will neutralize the voltage in a few seconds. However, for the fluttering crust, supercritical water (SCW), a strong and vast dielectric, electrically insulated the crust from below, so free electrons from the rest of the Earth could not flow up to neutralize the

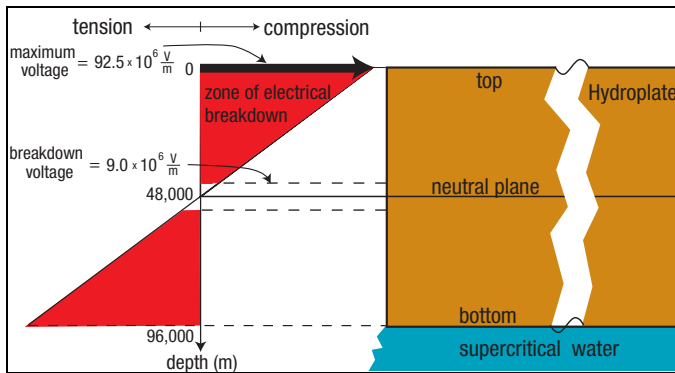

Figure 222: Sea of Neutrons. Piezoelectric voltages were produced by compressive and tensile stresses in the fluttering crust acting on trillions upon trillions of quartz crystals. Because those cyclic stresses varied from a maximum at the top and bottom of the crust to zero at the neutral plane in the middle, the piezoelectric voltages also decrease linearly to zero at the neutral plane. Therefore, the total piezoelectric voltages exceeded the breakdown voltage of 9×10^6 V/m throughout almost all of the 60-mile thick hydroplate (shown in red). However, the excess energy gained in accelerating electrons in the top and bottom of the hydroplate produced breakdown throughout the entire crust. This energy of almost

$$92.5 \times 10^6 \times 48,000 \times 0.5 = 2.2 \times 10^{12} = 2.2 \times 10^6 \text{ MeV}$$

was many orders of magnitude larger than the 10–19 MeV necessary for bremsstrahlung radiation to release free neutrons. Therefore, a sea of neutrons resulted which produced new isotopes throughout the crust.

voltage. As cyclic voltages built up and suddenly discharged within the fluttering crust, the electrical charges within the ionized SCW shifted back and forth by induction.

Once the temperature of quartz exceeds about 1,063°F (573°C), its atoms become mobile enough to reorient and neutralize any voltage.

81. Each quartz crystal, when stressed, sets up an electrical field which reinforces the electrical fields of all nearby quartz crystals. Each field's strength diminishes as the square of the distance from the crystal source, and is also reduced by about 80% by granite's permittivity (resistance to the electrical field). Nevertheless, so many crystals lie within granite that their three-dimensional integrated effect amounts to 7.4 times that of one quartz crystal alone.

In carrying out this integration, the granite hydroplate was divided into tiny but equal cubic volumes, each containing a quartz crystal. (Quartz crystals occupy about 27% of granite by volume.) Then, the effects of all quartz crystals were summed from 1 to infinity in all three dimensions. This uniformity assumption is conservative, since electrical breakdown will occur on the easiest path, not the harder paths that would exist if the quartz crystals were of identical sizes and uniformly spaced within the granite. Figure 222 shows that the entire hydroplate experienced electrical breakdown and a huge flux of neutrons from bremsstrahlung radiation.

Quartz crystals generate about 0.0625 volt (V) per meter for each N/m^2 (newton per square meter) of compression. [See <http://en.wikipedia.org/wiki/Piezoelectric>.] Granite's compressive strength is about 2×10^8 N/m^2 . The crushing seen within the granite crust tells us that such compressive stresses have been exceeded in the past, and the observed

electrical activity during modern earthquakes shows that breakdown thresholds are even being reached today. [See “Earthquakes and Electricity” on page 387.] Certainly, stresses exceeded this during the compression event that pushed up all of Earth's major mountain ranges. Therefore, electric fields of at least 92.5×10^6 V/m were reached in the extreme top and bottom of each hydroplate.

$$7.4 \times 0.0625 \frac{\text{volts}}{\text{m}} \frac{\text{m}^2}{\text{N}} \times 2 \times 10^8 \frac{\text{N}}{\text{m}^2} = 92.5 \times 10^6 \frac{\text{volts}}{\text{m}}$$

Notice in Figure 222 how this exceeds the breakdown voltage of dry granite: 9×10^6 V/m. [See *Smithsonian Physical Tables*, 9th revised edition (Norwich, N.Y., Knovel, 2003), p. 423.]

The total voltage generated in the fluttering crust is equal to the area of a red triangle in Figure 222 (volts/meter times the half-thickness of the crust in meters). This voltage (and therefore the z-pinching) was orders of magnitude greater than a brief 1-billion volt bolt of lightning is on our low-density atmosphere today. Shock collapse (explained on page 392) also contributed a powerful additional pinch as did the compression event and the pounding pillars.

Rock is weak in tension, so when the top half of a hydroplate was in the tension half of its flutter cycle, these high voltages were not reached near the Earth's surface (as they were in the compression half cycle). However, in the bottom half of a hydroplate, tension only means that the large compressive stresses due to the weight of the overlying rock were reduced by the amount of tension. Therefore, cyclic changes in stress in the bottom half, during both the tension and compression half cycle, produced these extreme voltages.

Temperature is another important variable. The above properties were measured at room temperatures. As temperatures increase up to the limit of 1,063°F (573°C) mentioned in Endnote 80, the piezoelectric coefficient increases and breakdown voltages decrease—both contributing to more extensive and powerful plasma production.

82. N. E. Ipe, “Radiological Considerations in the Design of Synchrotron Radiation Facilities,” Stanford Linear Accelerator Center, *SLAC-PUB-7916*, January 1999, p. 6.
83. To see why powerful bremsstrahlung radiation releases neutrons, a review will be helpful. On page 382, we introduced “the strong force” by asking, “Why don't large nuclei fly apart, since they contain positive charges (protons) which should repel each other?”

In addition to the strong force that holds tightly packed protons and neutrons together, neutrons inside a nucleus spread the protons farther apart, thereby reducing their mutual repulsion. That repelling force, like air pressure in a balloon, gives the nucleus a spherical shape if no other force acts upon it. However, if powerful piezoelectric voltages produce electrical surges near these nuclei, the electrons will

emit bremsstrahlung radiation as they decelerate. The trillions of cycles per second of alternating positive and negative charges in that radiation will vibrate the protons in the nucleus, so the nucleus takes on a different ellipsoid (or football) shape each cycle. The portions of the nucleus that are farthest from the center of the nucleus (at the tips of the football shape) will more nearly resemble *smaller, but neutron-heavy* nuclei. Therefore, they quickly expel neutrons.

As explained on page 381 in discussing the valley of stability, small stable nuclei usually have as many neutrons as protons. For example, helium usually has two of each, carbon has three of each, and oxygen has eight of each. For more massive nuclei to be stable more neutrons than protons are needed to spread the protons farther apart and reduce their mutual repulsion. (For example, uranium has 92 protons and most uranium nuclei have 146 neutrons.) Therefore, a powerfully vibrating heavy nucleus distorts into shapes where portions of the nucleus have too many neutrons close together. To be stable at that instant, those portions must expel a few neutrons. *This is why the powerful bremsstrahlung radiation during the compression event near the end of the flood released “a sea” of neutrons.*

If the neutrons released in each fission produce, on average, *exactly* one more fission, the concentration of ^{235}U is said to be critical. If more than one fission occurs on average, there is an explosion, as in an atomic bomb.

For the same reason, when a neutron—acting as a bullet—splits (fissions) a uranium-235 (^{235}U) nucleus, the two smaller fragments no longer need as many neutrons, so each typically releases two or three neutrons.

- ◆ Electrons accelerated in a plasma by high-energy lasers will produce neutrons, positrons, and fission fragments by bremsstrahlung radiation. [See P. L. Shkolnikov and A. E. Kaplan, “Laser-Induced Particle Production and Nuclear Reactions,” *Journal of Nonlinear Optical Physics and Materials*, Vol. 6, No. 2, 1997, pp. 161–167.]
84. *“The spatial variation in $\delta^{18}\text{O}$ (Fig. 1) can most easily be explained by the upward migration along the flank of the [salt] dome of diagenetically altered waters enriched in heavy oxygen”* Jeffrey S. Hanor, “Kilometre-Scale Thermohaline Overturn of Pore Waters in the Louisiana Gulf Coast,” *Nature*, Vol. 327, 11 June 1987, p. 501.
- ◆ *“Sulfate ions in saline lakes and brines have oxygen-18 enrichment of from 7 to 23 per mille relative to mean ocean water;”* A. Longinelle and H. Craig, “Oxygen-18 Variations in Sulfate Ions in Sea Water and Saline Lakes,” *Science*, Vol. 156, 7 April 1967, p. 56.
 - ◆ *“Results indicate both higher enrichments of heavier isotopes [of ^2H and ^{18}O] and higher chloride concentrations in water samples from salt pans than in water samples from other sources.”* H. Chandrasekharan et al., “Deuterium and Oxygen-18 Isotopes on Groundwater Salinization of Adjoining Salt Pans in Porbandar Coast, Gujarat, India,” *Hydrochemistry*, IAHS Publication No. 244, April 1997, p. 207.
85. *“All quartz-rich rocks (quartzites, granites, gneisses, mylonites) did show [statistically significant] piezoelectric effects when stressed.”* J. R. Bishop, “Piezoelectric Effects in Quartz-Rich Rocks,” *Tectonophysics*, Vol. 77, 20 August 1981, p. 297.
- ◆ *“... frequently in quartzite, the quartz occurs as grains with isometric form but shows a preferential orientation in terms of internal crystal structure, that is, in terms of the axes of crystallization.”* E. I. Parkhomenko, *Electrical Properties of Rocks* (New York: Plenum Press, 1967), p. 6.
86. J. R. Rygg et al., “Dual Nuclear Product Observations of Shock Collapse in Inertial Confinement Fusion,” *LLE Review*, Vol. 111, pp. 148–153.
87. The photo of this lightning rod can be seen at:
http://en.wikipedia.org/wiki/Plasma_pinch.
- After the owner of this photograph gave permission to use his image of the lightning rod, he withdrew permission, because he did not want his photo “used for such nonscientific purposes” as this book. (No one should think that all scientists are unbiased and freely exchange data and information. Some even suppress information.) In three other instances involving different topics, evolutionists denied permission to use photographs for this book, although copyright fees were offered.
88. Bennett, pp. 890–897.
89. The following definitions pertain to this calculation:
- mole:** the mass of a substance equal to its atomic or molecular weight expressed in grams. For example, a mole of carbon-12 weighs 12 grams. A mole of water (H_2O or $^1\text{H} + ^1\text{H} + ^{16}\text{O}$) is 18 grams of water.
- Avogadro’s number:** the number (6.022×10^{23}) of atoms or molecules in one mole. For example, 12 grams of carbon contain 6.022×10^{23} carbon atoms.
- erg:** a unit of energy or work done by a force of 1 dyne acting through a distance of 1 centimeter. For example, a 1-pound brick falling through 1 foot releases 13,600,000 ergs of energy.
- MeV:** a million electron volts (a small unit of energy). It is the energy gained by an electron accelerated through one million volts. A snowflake striking the concrete pavement releases about 4 MeV.
- fast neutron:** a free neutron with a kinetic energy of at least 1 MeV (traveling faster than 14,000 km/sec). Nuclear reactions (fission and fusion) produce fast neutrons.
- thermalize:** to slow the effective speed of a subatomic particle (usually a neutron) until it corresponds to the speeds of like particles at the local temperature.
- ◆ Our oceans have a total of 1.43×10^{24} grams of water. For every 18 grams of water (1 mole) there are 6.022×10^{23} (Avogadro’s number) water molecules—each with 2 hydrogen atoms. One out of every 6,400 hydrogen atoms in our oceans is heavy hydrogen (^2H , called deuterium). Each fast neutron thermalized by water produced at least 1 MeV of heat energy. (1 MeV = 1.602×10^{-6} erg) A hydrogen atom (^1H) that absorbs a fast neutron releases 2.225 MeV of

binding energy and becomes deuterium. So, assuming Earth had no unusual amount of deuterium before the flood, the amount of nuclear energy that was added to the subterranean water over several weeks, just in forming deuterium, was:

$$\frac{1.43 \times 10^{24}}{18} \times \frac{6.022 \times 10^{23}}{6,400} \times 2 \times (1 + 2.225) \times 1.602 \times 10^{-6} = 7.72 \times 10^{37} \text{ ergs}$$

This is the energy that would be released by 1,800 trillion 1-megaton hydrogen bombs! [See Endnote 3 on page 601.]

The crust became an Earth-size nuclear engine during the several weeks this nuclear energy was being generated. This is a conservative estimate of the nuclear energy added to the subterranean water, because other products of nuclear fission and decay would have added additional energy, and some water was expelled permanently from Earth. Energy was also required to form radioisotopes and, in effect, “lift” them high above the floor of the valley of stability; *energy was also absorbed in forming some elements heavier than iron.*

The above calculation shows why so much deuterium was in the subterranean chamber. The solar system and stars contain little deuterium (a fragile isotope), but comets and asteroids contain large amounts of deuterium. (The comet chapter, pages 301–335, explains why the water in comets came from the subterranean chamber.)

This huge energy release (7.72×10^{37} ergs) must first be seen from the perspectives of two calculations: (a) and (b) below. From the first, this energy will appear small, but from the second, it will seem too large. ***Then, to help resolve both, consider the remarkable ability of water—especially supercritical water—to absorb and transfer heat and expel that energy into outer space as kinetic energy in the fountains of the great deep.*** Some of that energy is still being expelled from what was the porous floor of the subterranean chamber. [See Figure 56 on page 125.]

- a. If 7.72×10^{37} ergs of energy were released uniformly in the Earth's crust over 40 days, how many watts of power would be emitted in every cubic centimeter?

Earth has a surface area of 5.1×10^{18} cm². Assuming the crust is 97×10^5 cm thick (about 60 miles), the average cubic centimeter of rock would generate only 0.05 watts.

$$\frac{7.72 \times 10^{37} \text{ ergs}}{5.1 \times 10^{18} \text{ cm}^2 \times 97 \times 10^5 \text{ cm} \times 40 \text{ days}} \times \frac{1 \text{ watt} - \text{day}}{8.64 \times 10^{11} \text{ ergs}} = 0.05 \frac{\text{watts}}{\text{cm}^3}$$

where a watt-day = 8.64×10^{11} ergs. A 100-watt light bulb releases energy almost 2,000 times faster. (Some 20-watt light bulbs are less than a cubic centimeter.)

- b. If 7.72×10^{37} ergs of *thermal energy* were evenly distributed throughout the Earth *at one time*, the Earth would melt! Earth's mass is 5.976×10^{27} grams. Let's assume that a rise in Earth's temperature of 1,784 K throughout would melt the Earth. Using the outer core's specific heat and heat of

fusion given in Table 45 on page 603, and neglecting the variation of these properties with pressure and temperature, the energy needed to melt the entire Earth is

$$5.976 \times 10^{27} \text{ gm} \left(5 \times 10^6 \frac{\text{ergs}}{\text{gmK}} \times 1784 \text{ K} + 4 \times 10^9 \frac{\text{ergs}}{\text{gm}} \right) = 7.72 \times 10^{37} \text{ ergs}$$

90. No liquid, including water, boils at its “boiling point.” The erroneous term arose before the mechanism of boiling was understood. To boil, a liquid's temperature must be somewhat above its so-called boiling point.

I once demonstrated this to friends in our heat-transfer laboratory at MIT, by showing how hard it was to boil from a perfectly smooth metal surface, one that had no surface cracks or valleys—liquid mercury. I placed liquid mercury in the bottom of a very clean beaker and then poured pure water (doubly distilled and degassed) on top. As the beaker was heated by radiation lamps, the water's temperature rose to 247°F (35 degrees above water's “boiling point” at atmospheric pressure). Clouds of steam increasingly rolled out of the beaker, but no boiling occurred. Then, a very large bubble suddenly grew from a nucleation site (a little pit) in a tiny, barely visible dust particle in my “clean” water. The bubble grew and rose so fast that the water splashed off the ceiling. The highly agitated water molecules in the liquid (with 35 degrees of superheat) were frantically seeking a vapor pocket into which they could jump. Probably there were millions of sub-microscopic vapor pockets, but their effective radius was so small that the surrounding liquid's surface tension was so powerful that the pressure inside was too high to form water vapor (steam).

A liquid's so-called boiling point is the temperature at which the vapor pressure of the liquid equals the pressure surrounding the liquid.

91. Yes, as the temperature of the SCW slowly increases, the average radius (*r*) of the microscopic liquid droplets becomes even smaller, so the surface tension (the inter-molecular forces) squeezing the droplets increases as $1/r$. Therefore, the pressure within the liquid droplets becomes much greater than the surrounding vapor's pressure. Simultaneously, as the average liquid droplet becomes smaller through evaporation, the vapor's density increases, so more vapor molecules merge at a faster rate to become microscopic liquid droplets, and more water molecules are ionized.
92. See “**Oil—and Mountains of Salt—All in the Right Places**” on page 396.
93. Granite typically has a tensile strength of 1,850 psi and a modulus of elasticity of 7,300,000 psi. Earth's crust has a mean circumference of 24,875 miles. Therefore, the strain just before the rupture was about

$$\frac{1,850 \text{ psi}}{7,300,000 \text{ psi}} \times 24,875 \text{ miles} = 6.3 \text{ miles}$$

Although other factors were involved, this might be, within an order of magnitude, the initial width of the rupture.

94. See “**Frequency of the Fluttering Crust**” on page 606.
95. See page 471 for confirmation of this in the paragraph quoted from *The Book of the Cave of Treasures* (A.D. 300–599).
96. Even dry salt (the mineral halite, NaCl) has a density 2.2 times than of water, while sediments have a density of about 3 times that of water.
97. “*Structural features such as salt domes and anticlines* [an archlike upfold] *are perhaps the most likely place to find hydrocarbons.*” Allen L. Hammond, “Bright Spot: Better Seismological Indicators of Gas and Oil,” *Science*, Vol. 185, 9 August 1974, pp. 515–517.
- ◆ “*Sand and sandstone formations make excellent reservoirs* [for oil], *and carbonate rocks* [such as salt domes] *may also be good.*” Arthur N. Strahler, *Physical Geology* (New York: Harper & Row, Publishers, 1981), p. 566.
98. The subterranean water reaches extremely high horizontal velocities as the chamber’s ceiling is pressed closer and closer to the chamber’s floor. See [Figure 76 on page 145](#) and notice what happens as y approaches zero.
99. A. A. Vostrikov et al., “The Effect of Thermal Explosion in a Supercritical Water,” *Technical Physics Letters*, Vol. 27, 2001, pp. 847–849.
- This paper describes the burning of certain hydrocarbons in SCW in a narrow temperature and pressure range. Methane (CH_4) and carbon dioxide (CO_2) were produced. It seems most likely that under different temperature and pressures, a wide variety of hydrocarbons would be produced.
- For example, SCW is seen jetting up from the floor of the Gulf of Mexico. That water is coming from the pore spaces in what remained of the preflood subterranean chamber floor. As that SCW enters the cold water immediately above the sea floor, asphalt (tar) is deposited.
- ◆ “*Even Jules Verne didn’t foresee this. Down at the bottom of the Atlantic Ocean is the hottest water on Earth, in a ‘supercritical’ state never seen before in nature ... and could offer a glimpse of how minerals such as gold, copper and iron are leached out of the entrails of the Earth and released into the oceans. Its water, but not as we know it ...*” Catherine Brahic, “Superheated Water Spews from the Seabed,” *New Scientist*, Vol. 198, 9 August 2009, p. 14.
 - ◆ “*Some tubeworm aggregations were completely embedded in solidified tar, indicating that they were later overcome by flows.*” I. R. MacDonald et al., “Asphalt Volcanism and Chemosynthetic Life in the Campeche Knolls, Gulf of Mexico,” *Science*, Vol. 304, 14 May 2004, p. 1000.
 - ◆ Martin Hovland et al., “Chapopote Asphalt Volcano May Have Been Generated by Supercritical Water,” *Eos*, Vol. 86, 18 October 2005, pp. 397–398.
100. In about 1982, I received a phone call from a scientist who, in 1942, participated at one of the most significant and dangerous experiments of all time. Enrico Fermi and his team had built the first nuclear reactor under the south side of the University of Chicago’s football stadium. It was a key step in the development of the atomic bomb.
- One of the fascinating details he shared was that they could measure with a Geiger counter the radiation building up in the room (a squash court), and knew that neutrons were buzzing all around and through their bodies. He also said that the one thing they knew about atoms was that *their nuclei were continually vibrating*.
101. George F. Bertsch, “Vibrations of the Atomic Nucleus,” *Scientific American*, Vol. 248, May 1983, p. 64.
102. Imagine that you are pushing a child in a swing. The swing has a natural frequency, perhaps one cycle every two seconds. If you push the child ten times per second or once every ten seconds, you won’t get good results. It is best to push at the natural vibrational frequency of the swing (once every two seconds). But that is not enough. If each of your pushes at the resonant frequency puts more energy (a force moving through a distance) into the pendulum-like swing than is lost by various types of friction, the swing’s amplitude steadily increases.
- The same thing happens in a nucleus whose vibrations are driven by streams of bremsstrahlung radiation, originating during the compression event from trillions of locations in the suddenly compressed hydroplates. Each stream contains some of the resonant frequencies—about 5×10^{21} cycles (or “pushes”) per second. Amplitudes steadily increase and nuclei are repeatedly distorted into unstable shapes and unstable internal configurations. Accelerated decay follows.
103. George Gamow, “Expanding Universe and the Origin of Elements,” *Physical Review*, Vol. 70, October 1946, pp. 572–573.
104. “*However, it was soon realized that the building up of heavy nuclei during the Big Bang could not have continued very far, because collisions between nuclei became less frequent as the universe cooled* [and expanded], *and the thermal energy of the nuclei became too low to overcome the electrostatic repulsion of their positive charges.*” Edward M. Baum et al., *Nuclides and Isotopes: Chart of the Nuclides*, 16th edition (Schenectady, NY: Knolls Atomic Power Laboratory, 2002), p. 34.
105. “*Elevated emanations of hydrogen, radon, helium, and other gases were detected over some of the lineaments, thus indicating anomalous permeability of these zones in comparison with adjacent areas.*” O. V. Anisimova and N. V. Koronovsky, “Lineaments in the Central Part of the Moscow Syncline and Their Relations to Faults in the Basement,” *Geotectonics*, Vol. 41, No. 4, 2007, p. 315.
106. “*... many lineaments are zones of seismic activity ...*” Ibid.
- ◆ “*... the main seismic activity is concentrated on the first and second rank lineaments, and some of [the] important epicenters are located near the lineament intersections. Stich et al., (2001) obtained from the analysis of 721 earthquakes with magnitude between 1.5 and 5.0 mb* [body-wave magnitude] *that the epicenters draw* [lie along] *well-defined lineaments and show two dominant strike directions N120–130°E and N60–70°E, which are coincident with known faults*

- systems in the area and with the source parameters of three of the largest events.*" A. Arellano Baeza et al., "Changes in Geological Faults Associated with Earthquakes Detected by the Lineament Analysis of the Aster (TERRA) Satellite Data," *Pagina Web De Geofisica*, December 2004, p. 1.
107. Ralph A. Alpher, Hans Bethe, and George Gamow, "The Origin of Chemical Elements," *Physical Review*, Vol. 73, April 1948, pp. 803–804.
108. "As already mentioned, there is no stable nucleus with five or eight nuclear particles [nucleons], so it is not possible to build nuclei heavier than helium by adding neutrons or protons to helium (^4He) nuclei, or by fusing pairs of helium nuclei. (This obstacle was first noted by Enrico Fermi and Anthony Tukevich.)" Steven Weinberg, *The First Three Minutes* (New York: Bantam Books, Inc., 1977), p. 119.
- ◆ The barrier at 5 nucleons causes almost instantaneous decays, with half-lives of less than 7.6×10^{-22} seconds.
109. "But the stellar theory of nucleosynthesis also had its problems. It is difficult to see how stars could build up anything like a 25–30 percent helium abundance—indeed, the energy that would be released in this fusion would be much greater than stars seem to emit over their whole lifetime." Weinberg, p. 120.
110. "A third alpha particle therefore has to be captured nearly simultaneously with the collision of the original pair [of alpha particles] for ^{12}C to be formed. This process is known as the triple-alpha reaction, and was first proposed in 1952. Oxygen is then created when ^{12}C captures a fourth alpha particle." Sofia Quaglioni, "Close Encounters of the Alpha Kind," *Nature*, Vol. 528, 3 December 2015, p. 42.
111. Serdar Elhatisari et al., "Ab *Initio* Alpha—alpha scattering" *Nature*, Vol. 528, 3 December 2015, p. 111–114.
112. "It seems probable that the elements all evolved from hydrogen, since the proton is stable while the neutron is not. Moreover, hydrogen is the most abundant element, and helium, which is the immediate product of hydrogen burning by the pp chain and the CN cycle, is the next most abundant element." Burbidge et al., p. 549.
113. Joseph Silk, *The Big Bang* (San Francisco: W. H. Freeman and Co., 1980), p. 79.
114. See Endnote 33 on page 142.
115. Charles Seife, "Accelerator Aims to Find the Source of All Elements," *Science*, Vol. 298, 22 November 2002, p. 1544.
- ◆ Other evolutionist journals also admit this.
Stars cook up nearly all of the approximately 60 atomic elements in people's bodies. But exactly how that works remains a mystery. Dolly Setton, "The Cosmic Recipe for Earthlings," *Discover*, September 2013, p. 10.
116. "... the temperatures in the interior of stars are measured in tens of millions of degrees, whereas several billion degrees are needed to 'cook' radioactive nuclei from the nuclei of lighter elements." George Gamow, *One Two Three ... Infinity*, Bantam Science and Mathematics edition (New York: The Viking Press, Inc., 1961), p. 329.
- Notice that researchers at the Proton-21 Electrodynamics Research Laboratory in the Ukraine, using a Z-pinch, are overcoming Coulomb forces and producing heavy elements by fusion at close to these billion-degree temperatures. [See page 384.] However, it happens briefly (in 10^{-8} second) in a "hot dot" that is less than 10^{-7} millimeter in diameter. Supernovas are not needed, only a focused and concentrated plasma.
117. If supernovas produced all the chemical elements that are heavier than iron (and their isotopes), supernova debris should show spectroscopically all those elements produced by the r-process (rapid process) for the capture of neutrons. It should be a simple matter to show thousands of heavy isotopes present in the spectrographs of supernova remnants.
...we have no spectroscopic evidence that r-process elements have truly been produced. Stephen Rosswog, "Radioactive Glow as a Smoking Gun," *Nature*, Vol. 500, 29 August 2013, p. 536.
- Cobalt-56 and cobalt-57 are seen in supernova remnants, causing some to claim that cobalt is produced by supernovas. The current theoretical understanding of the events leading to a supernova have nickel decaying into cobalt before the supernova, thereby powering the supernovae. The cobalt was not produced by the supernova.
The nickel decays radioactively into cobalt, which then decays radioactively into iron, powering the supernova's incandescence. Yudhijit Bhattacharjee, "Death of a Star," *Science*, Vol. 339, 4 January 2013, p. 23.
118. "Models indicate that supernovae do not create enough of the elements heavier than iron to account for the amounts of these elements found in the universe." Neil F. Comins and William J. Kaufmann, *Discovering the Universe* (New York: W. H. Freeman and Co., 2009), p. 238.
119. "The simplest interpretation of this linear relation is that the radioactivity measured at the surface is constant from the surface to depth b." Roy et al., p. 1.
- Roy then calculates that throughout the eastern United States, $b = 4.68$ miles, but increases slightly for other regions, such as the western United States and parts of Australia.
120. If the base of a semi-infinite, 4.68-mile-thick slab of rock is heated from below by a steady heat source, half that heat flux will pass through the top of the slab in 1.5-million years. After 40-million years, 90% of the heat flux entering from below would reach the surface. For each doubling of the slab's thickness, the time required for a given fraction of the heat flux to reach the surface increases by a factor of four.
121. Arthur H. Lachenbruch, "Crustal Temperature and Heat Production: Implications of the Linear Heat-Flow Relation," *Journal of Geophysical Research*, Vol. 75, No. 17, 10 June 1970, pp. 3291–3300.

122. “Heat production rate is well correlated to lithology; no significant variation with depth, neither strictly linear nor exponential, is observed over the entire depths of the [two German holes].” Christoph Clauser et al., “The Thermal Regime of the Crystalline Continental Crust: Implications from the KTB,” *Journal of Geophysical Research*, Vol. 102, No. B8, 10 August 1997, p. 18,418.
123. Frank D. Stacey, *Physics of the Earth* (New York: John Wiley & Sons, 1969), p. 244.
124. Frank D. Stacey, *Physics of the Earth*, 3rd edition (Brisbane, Australia: Brookfield Press, 1992), pp. 62–65.
125. “Even larger amounts of neutrons can be generated [by bremsstrahlung radiation in heavy chemical elements], in particular in natural uranium.” Shkolnikov and Kaplan, p. 165.
126. Josh Dean, “This Machine Might Save the World,” *Popular Science*, January 2009, pp. 64–71.
127. “[At the Oklo reactor] most of the fission-product elements and the neutron capture products have remained partially or wholly in place.” George A. Cowan et al., “The Oklo Phenomenon,” p. 342.
128. “Helium-3 occurs as a primordial nuclide, escaping from the Earth’s crust into the atmosphere and into outer space over millions of years.” <http://en.wikipedia.org/wiki/Helium-3>.
129. Frank D. Stacey, *Physics of the Earth* (New York: John Wiley & Sons, 1969), p. 240.
130. Dehydroxylation is the removal of hydroxide ions (OH⁻) from a mineral’s crystalline structure by the application of heat and high pressures. Usually the heat and pressure are applied to a large mass of the mineral. However, in the case at hand, a ²¹⁸Po atom impacting a mineral containing hydroxide would concentrate tremendous heat and pressure near the impact point, release thousands of OH⁻ ions from their crystalline structure, form water (HOH), and result in dehydroxylation. The reaction is of the type

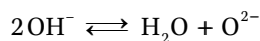

[See Douglas Yeskis et al., “The Dehydroxylation of Kaolinite,” *American Mineralogist*, Vol. 70, 1985, pp. 159–164.] Flowing water then dissolves and removes the O²⁻ ion.

To appreciate the large number of particles that might be removed by the impact of just one ²¹⁸Po atom—or the decay of an embedded ²¹⁸Po atom—consider the following. At 100°C and atmospheric pressure, 539 calories of heat will evaporate 1 gram of liquid water. (1 MeV = 3.83 × 10⁻¹⁴ cal) Eighteen grams of water (1 mole) contains 6.022 × 10²³ molecules. Therefore, the kinetic energy of one recoiling ²¹⁸Po (2% of the 5.49 MeV of energy released by the decay of ²²²Rn) could, if concentrated, evaporate up to

$$\frac{0.02 \times 5.49 \times 3.83 \times 10^{-14} \times 6.022 \times 10^{23}}{539 \times 18} = 2.6 \times 10^5 \text{ molecules}$$

131. After etching mica sheets with acid, Robert Gentry could see tiny pits where heavy, recoiling atoms had impacted after ejecting an alpha particle. He assumed those pits were made

by recoiling polonium. Pit densities near isolated polonium halos were no greater than the pit densities far from halos. Therefore, he concluded that *diffusion or slow movement did not* transport polonium (an alpha emitter) into the halo centers. If that had happened, some polonium would have decayed as the polonium converged on those centers, so pit densities would have been greater near polonium halos. [See Robert V. Gentry, “Fossil Alpha-Recoil Analysis of Certain Variant Radioactive Halos,” *Science*, Vol. 160, 14 June 1968, pp. 1228–1230.] This led to his eventual conclusion that the hundreds of millions of polonium isotopes must have been clustered at specific points *since the instant of creation*.

However, Gentry overlooked the powerful positive electrical charges at certain impact points and the rapid transport of ²²²Rn in flowing water along channels between growing sheets of mica. [See “**Frequency of the Fluttering Crust**” on page 606.] A flowing ²²²Rn atom that emitted an alpha particle instantly became ²¹⁸Po with a -2 electrical charge. That new polonium was pulled into the nearest point of positive charge in seconds. Then, when the anchored polonium decayed minutes later, heat from its recoil evaporated more negatively charged hydroxide particles, so those points became even more positively charged and attracted more polonium even faster from greater distances. Almost all the uniformly distributed recoil pits Gentry saw were produced by decaying ²²²Rn, not decaying polonium.

132. Ejaz ur Rehman et al., “Mass Spectrometric Determination of ²³⁴U/²³⁸U Ratio with Improved Precision,” *Analytical Chemistry*, Vol. 77, 1 November 2005, pp. 7098–7099.
133. This short-sighted argument was raised by Stanley Fresco, in “Evidence Supporting a Great Age for the Universe,” *Creation/Evolution*, Fall 1980, p. 38.
134. Richard A. Kerr, “Meteorite Mystery Edges Closer to An Answer—Or the End of a Field,” *Science*, Vol. 341, 12 July 2013, p. 126.
135. This is a major problem for evolutionists who visualize chondrules being formed at the extremely low pressures and temperatures of outer space. (At low pressures, volatiles bubble out quickly—like gas escaping from the sudden opening of a carbonated beverage.) However, the hydroplate theory explains the retention of volatiles, because they formed under the high confining pressures inside rocks in the subterranean chamber. Also, they froze seconds after escaping from the hot, high-pressure, subterranean chamber. [See “**Rocket Science**” on pages 581–582.]
136. Naoyuki Fujii and Masamichi Miyamoto, “Constraints on the Heating and Cooling Processes of Chondrule Formation,” *Chondrules and Their Origins*, editor Elbert A. King (Houston: Lunar and Planetary Institute, 1983), pp. 53–60.
- ◆ Impact melting would not duplicate characteristics in and around chondrules. [See J. A. Wood and H. Y. McSween Jr., “Chondrules as Condensation Products,” *Comets, Asteroids, Meteorites*, editor A. H. Delsemme (Toledo, Ohio: The University of Toledo, 1977), pp. 365–373. Also see T. J. Wdowiak, “Experimental Investigation of Electrical

- Discharge Formation of Chondrules,” *Chondrules and Their Origins*, pp. 279–283.] Donald E. Brownlee et al. give seven other reasons why impact melting did not produce chondrules. [See “Meteor Ablation Spherules as Chondrule Analogs,” *Chondrules and Their Origins*, p. 23.]
137. T. D. Swindle et al., “Radiometric Ages of Chondrules,” *Chondrules and Their Origins*, pp. 246–261.
- ◆ “CAIs [calcium-aluminum-rich inclusions] *are believed to have formed about two million years before the chondrules. Here we report the discovery of a chondrule fragment embedded in a CAI.*” Shoichi Itoh and Hisayashi Yurimoto, “Contemporaneous Formation of Chondrules and Refractory Inclusions in the Early Solar System,” *Nature*, Vol. 423, 12 June 2003, p. 728. [See also “Mixed-Up Meteorites” on page ix and “A Question of Timing” on page 691.]
138. Richard Ash, “Small Spheres of Influence,” *Nature*, Vol. 372, 17 November 1994, p. 219.
139. “*As already described, the separated chondrules in the polished mount frequently grade into material similar to the matrix around their peripheries. ... boundaries between chondrules and matrix are frequently very gradational.*” R. M. Housley and E. H. Cirlin, “On the Alteration of Allende Chondrules and the Formation of Matrix,” *Chondrules and Their Origins*, p. 152.
140. These researchers include: A.G. W. Cameron, E. Levy, S. Love, J. Wasson, and Fred L. Whipple. Whipple specifically refers to the Z-pinch as necessary to focus enough energy to suddenly melt tiny chondrules. [See Fred L. Whipple, “Chondrules: Suggestion Concerning the Origin,” *Science*, Vol. 153, 1 July 1966, pp. 54–56.]
141. Alan E. Rubin, “Secrets of Primitive Meteorites,” *Scientific American*, Vol. 308, February 2013, p. 41.
142. “*Clear evidence of [former] ⁶⁰Fe in chondrites was first found in troilite (FeS) and magnetite (Fe₃O₄).*” Shogo Tachibana et al., “⁶⁰Fe in Chondrites: Debris from a Nearby Supernova in the Early Solar System?” *The Astrophysical Journal*, Vol. 639, 10 March 2006, pp. L87–L90.
- ◆ “[Researchers] *analyzed two primitive meteorites that are thought to be almost pristine leftovers of solar system formation. They detected nickel 60, the product of the radioactive decay of iron 60, in chemical compounds where, by rights iron should be found.*” Simon F. Portegies Zwart, “The Long-Lost Siblings of the Sun,” *Scientific American*, Vol. 301, November 2009, p. 42.
 - ◆ “*Recent studies of meteorites confirm the presence of live ⁶⁰Fe in the early solar system.*” J. Jeff Hester et al., “The Cradle of the Solar System,” *Science*, Vol. 304, 21 May 2004, p. 1116.
143. What is meant by “quickly”? Supernovas are the hottest and most violent explosions observed in the universe. If mineral grains are somehow to form from a supernova, the gas/plasma debris from the supernova must first merge into microscopic particles. That is quite a trick, because the expanding gas/plasma moves radially outward, steadily increasing the distances between most of its atomic and subatomic particles. Martin Harwit calculates that to grow a grain to only 10⁻⁵ centimeter would require 3-billion years—*assuming no expansion and that every particle that strikes a growing grain would stick.* Sir Fred Hoyle put it more bluntly; “... *there is no reasonable astronomical scenario in which mineral grains can condense.*” [See “**Interstellar Gas**” on page 95.]
- Second, these tiny grains (drifting weightlessly in space) must gravitationally collect into small bodies. Then, those bodies must somehow merge into asteroid-size bodies, massive enough to compress and heat (in a nearly absolute zero, environment) the grains into uniform crystals. At that point, enough ⁶⁰Fe atoms might be concentrated to form minerals, such as troilite (FeS) and magnetite (Fe₃O₄). How long would this second step take? No one can say for sure, but probably most astronomers have an opinion. If they were candid, I suspect many would say that this second step couldn’t happen in 10,000,000 years. But almost all the ⁶⁰Fe (half-life 1,500,000 years) would have decayed before then. Neither the first nor the second step could happen quickly enough to form detectable crystals containing ⁶⁰Fe.
144. “*The supernova was stunningly close; much closer to the sun than any star is today.*” Brian D. Fields, as quoted by the University of Illinois News Bureau, 10 April 2006. See <http://news.illinois.edu/NEWS/06/1004solar.html>
- ◆ Leslie W. Looney, John J. Tobin, and Brian D. Fields, “Radioactive Probes of the Supernova-Contaminated Solar Nebula,” *The Astrophysical Journal*, Vol. 652, 1 December 2006, pp. 1755–1762.
145. George Cooper et al., “Carbonaceous Meteorites As a Source of Sugar-Related Organic Compounds for the Early Earth,” *Nature*, Vol. 414, 20/27 December 2001, pp. 879–883.
146. Peter R. Briere and Kathryn M. Scanlon, “Lineaments and Lithology Derived from a Side-Looking Airborne Radar Image of Puerto Rico,” U.S. Geological Survey Open-File Report 00-006, 2000, pp. 1–5.
147. John W. Harbaugh et al., “Reconstructing Late Cenozoic Stream Gradients from High-Level Chert Gravels in Central Eastern Kansas,” *Current Research in Earth Sciences*, Bulletin 253, 2007, p. 14.
148. “*The observation that Mars’ northern polar cap barely deforms [from season to season] implies that its planetary interior is colder than expected.*” Matthias Grott, “Is Mars Geodynamically Dead?” *Science*, Vol. 320, 30 May 2008, p. 1171.
- “*This result is surprising. First, the temperatures in the interior of terrestrial planets should be proportional to their radius if they started with the same amount and distribution of radioactive, heat-producing elements and then cooled through surface losses. In this case, [the surface heat loss from] Mars would be expected to plot between Earth and the Moon. However, the new estimates imply that the martian heat flow, a measure for the temperatures in the planetary interior, is below that of the Moon, even though Mars is about twice the diameter.*” Ibid.

- ◆ *“Mars probably has subchondritic heat sources”* [that is, less heat-generating radioactive material than is contained in the meteoritic material from which it supposedly formed]. Roger J. Phillips et al., “Mars North Polar Deposits: Stratigraphy, Age, and Geodynamical Response,” *Science*, Vol. 320, 30 May 2008, p. 118585.
- 149. Paul M. Myrow et al., “Extraordinary Transport and Mixing of Sediment across Himalayan Central Gondwana during the Cambrian-Ordovician,” *Geological Society of America Bulletin*, Vol. 122, September/October 2010, p. 1660.
- 150. Ping Wang et al., “Tectonic Control of Yarlung Tsangpo Gorge Revealed by a Buried Canyon in Southern Tibet,” *Science*, Vol. 346, 21 November 2014, p. 979.
- ◆ *“The constant river gradient strongly suggests a rapid uplift event created the gorge, rather than the river incision as previously believed.”* Stella Hurtley, “Tibetan Gorge Avoids a Tectonic Aneurysm,” *Science*, Vol. 346, 21 November 2014, p. 960.
- 151. Burbidge et al., pp. 547–650.
- 152. *“Optical measurements of the beryllium and boron abundances in halo stars have been achieved by the 10 meter KECK telescope and the Hubble Space Telescope. These observations indicate a quasi linear correlation between Be and B vs. Fe, at least at low metallicity, which, at first sight, is contrary to a dominating GCR [Galactic Cosmic Ray] origin of the light elements which predicts a quadratic relationship. As a consequence, the theory of the origin and evolution of LiBeB nuclei has to be refined.”* E. Vangioni-Flam and M. Cassé, p. 77.
- 153. *“The Rn-222 alpha particle map shows that radon gas was emanating from the vicinity of craters Aristarchus and Kepler at the time of Lunar Prospector.”* Stefanie L. Lawson et al., “Recent Outgassing from the Lunar Surface: The Lunar Prospector Alpha Particle Spectrometer,” *Journal of Geophysical Research: Planets*, Vol. 110, September 2005. p. E09009.
- 154. A blind test requires that the people making the measurements not know (be “blind” to) which of several specimens is the one of interest. For example, to measure a rock’s age by some radiometric technique, similar rocks—of different, but known, ages—must accompany the rock of interest. Only after the measurements are announced are the technicians making the measurements told the history of any specimen. Subtle biases can influence the experimental procedure if individuals with vested interests in the test’s outcome make the measurement or influence those who do. Blind tests ensure objectivity.

A special type of blind test commonly used in medicine is a “double-blind test.” Neither doctors nor patients know who receives the special treatment being tested. A random selection determines which patients receive the special treatment and which receive a placebo—something obviously ineffective, such as a sugar pill. Experienced medical researchers give little credibility to any medicine or treatment that has not demonstrated its effectiveness in a well-designed and rigorously executed double-blind test.

The Shroud of Turin, claimed to be the burial cloth of Christ, was supposedly dated by a blind test. Actually, the technicians at all three laboratories making the measurements could tell which specimen was from the Shroud. [Personal communication on 19 July 1989 with Dr. Austin Long, who participated in the radio-carbon dating.] The test would have been blind if the specimens had been reduced to unidentified carbon powder before they were given to the testing laboratories.

Actually, a more precise dating method for the Shroud had already been discovered. A Roman coin (a Pontius Pilate *lepton*) had been placed over the right eye of the man whose image was on the Shroud. That coin was minted between 29 AD and 32 AD. Discernible on the coin was a misspelled word, which further identifies the coin, because “at least four other Pilate coins currently exist that exhibit this misspelling.” Placing coins over the eyes of the deceased was a common burial practice in Jerusalem between the 1st Century BC through the 1st Century AD. [See Mark Antonacci, *Test the Shroud at the Atomic and Molecular Levels* (United States: LE Press, LLC, 2015), pp. 69-75.]

Radiometric dates that do not fit the favored theory are often thrown out by alleging contamination. Few ever hear about such tests. If those who object to a blind radiometric date have not identified the contamination before the test, their claims of contamination should carry little weight. Therefore, careful researchers should first objectively evaluate the possibility of contamination.

Humans are naturally biased. We tend to see what we want to see and explain away unwanted data. This applies especially to those proposing theories, myself included. Scientists are not immune to this human shortcoming. Many popular ideas within geology would probably never have survived had a critical age measurement been subjected to a blind test.

- 155. John Woodmorappe, “Radiometric Geochronology Reappraised,” *Creation Research Society Quarterly*, Vol. 16, September 1979, pp. 102–129.
- ◆ Robert H. Brown, “Graveyard Clocks: Do They Tell Real Time?” *Signs of the Times*, June 1982, pp. 8–9.
- ◆ *“It is obvious that radiometric techniques may not be the absolute dating methods that they are claimed to be. Age estimates on a given geological stratum by different radiometric methods are often quite different (sometimes by hundreds of millions of years). There is no absolutely reliable long-term radiological ‘clock.’”* William D. Stansfield, *Science of Evolution* (New York: Macmillan Publishing Co., 1977), p. 84.
- 156. *“Chemical and physical processes such as mantle convection, tectonic-plate recycling and magma generation through partial melting should have scrambled, if not obliterated, any coherent geochemical signature of the primordial material. Even if a vestige of such material remained, it seems unlikely that it would be found in any samples from Earth’s surface or the shallow subsurface that are available to geologists. Yet that is what [this] new evidence suggests.”* David Graham, “Relict Mantle from Earth’s Birth,” *Nature*, Vol. 466, 12 August 2010, p. 822.

- ◆ *“Cenozoic-Era Baffin Island and West Greenland lavas, previously found to host the highest terrestrial-mantle $^3\text{He}/^4\text{He}$ ratios, exhibit primitive lead-isotope ratios that are consistent with an ancient mantle source age of 4.55–4.45 Gyr [billion years]. The Baffin Island and West Greenland lavas also exhibit $^{143}\text{Nd}/^{144}\text{Nd}$ ratios similar to values recently proposed for an early-formed (roughly 4.5 Gyr ago) terrestrial mantle reservoir.”* Matthew G. Jackson et al., “Evidence for the Survival of the Oldest Terrestrial Mantle Reservoir,” *Nature*, Vol. 466, 12 August 2010, p. 853.
- 157. *“Beyond its Fe deficiency, the singular feature of HE0107–5240 is that its measured abundance of C, relative to Fe, is about 10,000 times the observed ratio of these elements in the Sun, the largest such ‘over-abundance’ ratio ever seen. The N abundance ratio is also greatly enhanced, though only by a factor of 200.”* Timothy C. Beers, “Telling the Tale of the First Stars,” *Nature*, Vol. 422, 24 April 2003, p. 825.
- 158. Beth Geiger, “Relics of Earth’s Birth Still Linger,” *Science News*, Vol. 189, 11 June, 2016, p. 13.
- 159. Hanika Rizo et al., “Preservation of Earth-Forming Events in the Tungsten Isotopic Composition of Modern Flood Basalts,” *Science*, Vol. 352, 13 May 2016, pp. 809–812.
- 160. *“The ancient remnants somehow escaped being mixed by convection currents in the mantle.”* Geiger, p. 13.
- 161. Silk, p. 124.
- 162. Baum et al., p. 34.

Why Are Creation and the Flood Important?

How Can the Study of Creation Be Scientific?

What Triggered the Flood?

Is Evolution Compatible with the Bible?

Why Did the Flood Water Drain So Slowly?

Have Scientific Tools Detected Adam and Eve within Us?

Is There Life in Outer Space?

HOW OLD DO EVOLUTIONISTS SAY THE UNIVERSE IS?

Is There a Large Gap of Time between Genesis 1:1 and 1:2?

Galaxies Are Billions of Light-Years Away, So Isn't the Universe Billions of Years Old?

Why Is the Universe Expanding?

Why do Creation Organizations Have Differences?

WHAT ARE THE PREDICTIONS OF THE HYDROPLATE THEORY?

Does the New Testament Support Genesis 1–11?

Why Did People Live 900 Years before the Flood?

How Can Origins Be Taught in High School or College?

How Can I Become Involved in This Issue?

How Could Saltwater and Freshwater Fish Survive the Flood?

What Are the Social Consequences of Belief in Evolution?

What Is the Written Debate Offer?

Global Warming Is Occurring, but What Causes It?

Why Have So Few Human Fossils Been Found?

Did a Water Canopy Surround the Earth and Contribute to the Flood?

How Do You Respond to Common Claims of Evolutionists?

What Questions Could I Ask Evolutionists?

Did the Flood Last 40 Days and 40 Nights?

Why Don't Creationists Publish in Leading Science Journals?

If God Made Everything, Who Made God?

Have Planets Been Discovered Outside the Solar System?

What about the Dinosaurs?

How Was the Earth Divided in Peleg's Day?

How Accurate Is Radiocarbon Dating?

What Is the Direct (Oral and Written) Exchange?

If the Sun and Stars Were Made on Day 4, What Was the Light of Day 1?

DID IT RAIN BEFORE THE FLOOD?

Is the Hydroplate Theory Consistent with the Bible?

How Did Human "Races" Develop?

How Do Evolutionists Respond to What You Say?

What Was Archaeopteryx?

According to the Bible, When Was Adam Created?

Figure 223: Frequently Asked Questions.

Part III:

Frequently Asked Questions

Most questions concerning origins are answered in Parts I and II of this book. Of the questions that remain, the following are some of the most frequently asked in my seminars and public presentations. These topics can be read in any order.

- ◆ [Why Are Creation and the Flood Important?](#) p. 436
- ◆ [How Can the Study of Creation Be Scientific?](#) p. 438
- ◆ [Why Is the Universe Expanding?](#) p. 439
- ◆ [Galaxies Are Billions of Light-Years Away, So Isn't the Universe Billions of Years Old?](#) p. 454
- ◆ [If the Sun and Stars Were Made on Day 4, What Was the Light of Day 1?](#) p. 460
- ◆ [How Old Do Evolutionists Say the Universe Is?](#) p. 461
- ◆ [What Was Archaeopteryx?](#) p. 464
- ◆ [What Are the Predictions of the Hydroplate Theory?](#) p. 468
- ◆ [What Triggered the Flood?](#) p. 469
- ◆ [Did It Rain before the Flood? What Generated the Preflood Mist?](#) p. 475
- ◆ [Have Parts of the Collapsed Subterranean Chamber Been Found?](#) p. 479
- ◆ [Why did the Moon Roll—and When?](#) p. 481
- ◆ [When Was the Flood, the Exodus, and Creation?](#) p. 482
- ◆ [Did the Flood Last 40 Days and 40 Nights?](#) p. 485
- ◆ [Could Earth's Mountain Ranges Form in Less Than an Hour?](#) p. 486
- ◆ [Is the Hydroplate Theory Consistent with the Bible?](#) p. 488
- ◆ [What about the Dinosaurs?](#) p. 493
- ◆ [Why Is Global Warming Occurring? What Can Be Done about It?](#) p. 495
- ◆ [Does Recently Declassified Data Falsify Plate Tectonic Theory?](#) p. 500
- ◆ [Why Have So Few Human Fossils Been Found?](#) p. 501
- ◆ [How Could Saltwater and Freshwater Fish Survive the Flood?](#) p. 502
- ◆ [Why Did the Floodwater Drain So Slowly?](#) p. 503
- ◆ [According to the Bible, When Was Adam Created?](#) p. 505
- ◆ [How Accurate Is Radiocarbon Dating?](#) p. 506
- ◆ [Why Did People Live for about 900 Years before the Flood?](#) p. 510
- ◆ [Have Planets Been Discovered Outside the Solar System?](#) p. 513
- ◆ [How Was the Earth Divided in Peleg's Day?](#) p. 515
- ◆ [Did a Water Canopy Surround Earth and Contribute to the Flood?](#) p. 518
- ◆ [Why Don't Creationists Publish in Leading Science Journals?](#) p. 526
- ◆ [How Did Human "Races" Develop?](#) p. 527
- ◆ [Is There a Large Gap of Time between Genesis 1:1 and 1:2?](#) p. 529
- ◆ [Is There Life in Outer Space?](#) p. 531
- ◆ [Have Scientific Tools Detected Adam and Eve within Us?](#) p. 534
- ◆ [Is Evolution Compatible with the Bible?](#) p. 537
- ◆ [What Questions Could I Ask Evolutionists?](#) p. 545
- ◆ [How Can Origins Be Taught in High School or College?](#) p. 548
- ◆ [What Are the Social Consequences of Belief in Evolution?](#) p. 551
- ◆ [Does the New Testament Support Genesis 1–11?](#) p. 553
- ◆ [How Can I Become Involved in This Issue?](#) p. 556
- ◆ [Why Do Creation Organizations Have Differences?](#) p. 557
- ◆ [How Harmful Is False Scientific Information?](#) p. 565
- ◆ [How Do You Respond to Common Claims of Evolutionists?](#) p. 566
- ◆ [How Do Evolutionists Respond to What You Say?](#) p. 568
- ◆ [If God Made Everything, Who Made God?](#) p. 569
- ◆ [What Is the Written Debate Offer?](#) p. 570
- ◆ [What Is the Direct \(Oral and Written\) Refereed Exchange?](#) p. 571

Why Are Creation and the Flood Important?

First, let's acknowledge why some people reject Genesis and are not willing to carefully consider

- ◆ how the universe, Earth, and life began, and
- ◆ the flood—Earth's defining geological event.

The following reflects attitudes I once held.

In our scientifically “enlightened” and media-driven age, don't educated people accept that evolution happened? Most of my teachers and professors, people I greatly respected, accepted evolution. Prior to 1970, it appeared to me that those who believed in the biblical version of creation did not grasp the immense age of the Earth and universe. Don't we sense great age when we see the Grand Canyon or galaxies that are billions of light-years away? Given billions of years, vast changes will occur. To believe that a worldwide flood occurred seemed ridiculous. Just look at a globe. Where could so much water come from to cover, as the Bible clearly states, all the mountains of the Earth? Mount Everest rises 5½ miles above sea level. If that much water once covered the Earth, where did all that water go? Obviously, the Bible was written in an age when people were relatively uneducated and little was known about the Earth—or so I thought.

Was I curious enough to study origins? No. I thought it was a complex, time-consuming subject. Besides, I felt that the case was closed a century ago—certainly after the famous Scopes Trial in 1925. Those who accepted the biblical version of creation and a global flood were a little embarrassing to be around. I became a Christian in high school, but held the above attitudes until my early 30s. I was at Position 1, shown in Figure 224.

Others reject the theory of evolution, accept a global flood, and believe that God created everything relatively recently. Although their beliefs, usually based on a literal interpretation of the Bible, clash with evolution (taught in almost all schools and universities), they tend to ignore the conflict. The reasons are many: they may be too busy, they may not recognize all the contradictions between evolution and the Bible or may feel powerless to resolve them. They may wish to avoid controversy or involvement in unfamiliar scientific topics. They may have only a vague understanding of the flood. (Major consequences of the flood have been incorrectly interpreted as supporting evolution.) They may not realize that evolution (1) is scientifically bankrupt, (2) is a major stumbling block for countless nonbelievers, and (3) has caused many children raised in Christian homes to later reject their faith, feel their parents misled them, or view church as irrelevant. This is Position 3.

Other people know how foundational Genesis 1–11 is to the entire Bible. (Genesis 1–11 tells of the creation, fall, and flood—three of the most significant events of all time.) Every New Testament writer and many Old Testament writers refer to those chapters. [See “**Does the New Testament Support Genesis 1–11?**” on pages 553–556.]

If those writers were wrong about ancient history, why should we believe them when they say that a man rose from the dead? Jesus Christ also spoke of events described in each of the first seven chapters of Genesis. If Christ was mistaken about ancient history, why should we believe Him when He speaks of eternity? If Genesis 1–11 is in error, then many other portions of the Bible that refer to those chapters are equally wrong, opening the door to differing interpretations of the entire Bible and a comfortable, pick-and-choose view of Scripture. *If evolution happened, then death existed for a billion years before man evolved. Death would not be a consequence of Adam's sin; Adam's sin would simply be a fiction, believed only by “literalists.” And if sin is a fiction, we don't need a Savior! (Also, if there is no such thing as sin—or a Creator—there are no moral absolutes. See “Does a Belief in Evolution have Social Consequences?” on pages 551–553.)*

These are scary thoughts for countless Christians. Some search for ways to reinterpret the Bible to harmonize it with evolution. They are called “theistic evolutionists.” The last thing they want to do is argue with scientists. Preserving image and intellectual respectability is important, and scientific answers may seem more credible and objective than various theological positions. Others who have great confidence in and knowledge of the Bible know that these Bible reinterpretations produce more contradictions than they resolve. [See “**Is Evolution Compatible with the Bible?**” on pages 537–545.] A Christian leader, whose primary interest is increasing church attendance and donations, may wish the whole, creation-evolution issue would just go away. Churches strive for internal harmony; raising the origins issue could bring disharmony, even church splits. Therefore, many church leaders, unaware that the science is clearly on their side, avoid the origins issue, even if evangelism suffers. They hold Position 4.

Finally, those holding Positions 2 and 5 are examining the evidence. Most are surprised and excited by what they are learning. After seeing the evidence, the frequent reaction is, “Why haven't I been told this before?” Instead of being intimidated by science, a subject they may have disliked in school, they are amazed at the simple, compelling evidence for creation and a global flood. Hundreds of topics and scientific discoveries supporting creation and the flood fascinate most people and are easy to discuss, even with strangers. In effect, this becomes a powerful pre-evangelistic tool. While no one has all the answers concerning origins, be assured that the scientific evidence is overwhelmingly consistent with Genesis 1–11 and opposes evolution. In fact, it is extremely difficult to find any knowledgeable evolutionist willing to debate the issue—orally or in writing—with someone who understands this evidence.

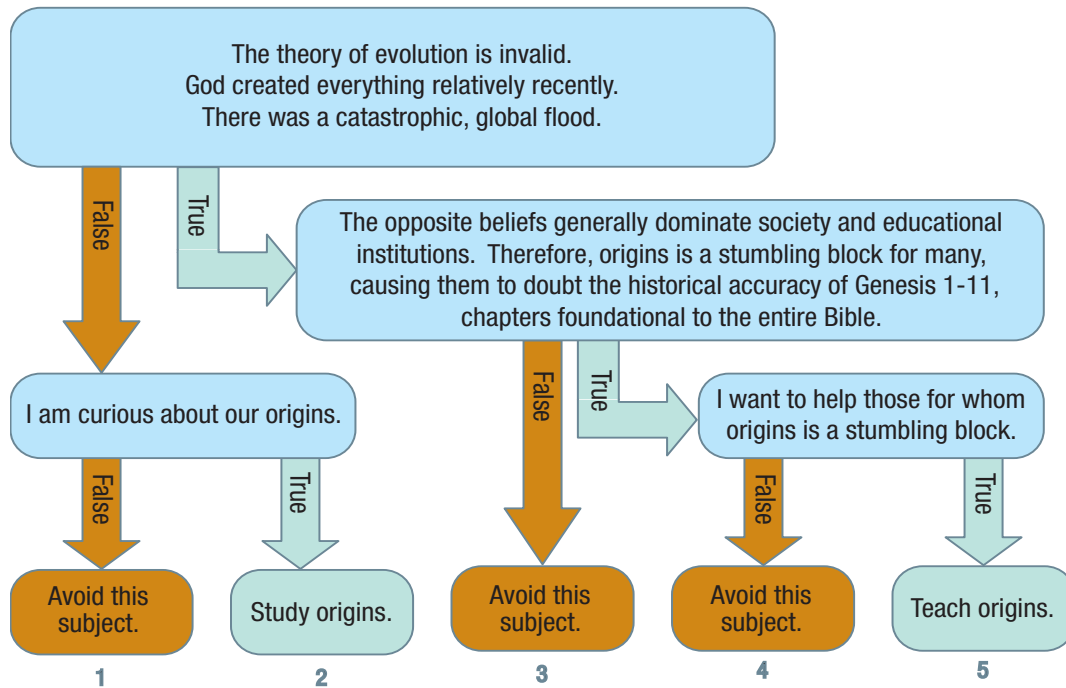

Figure 224: Five Views on Origins. People generally fall into five categories when it comes to the question of origins. Individuals of all ages and academic, scientific, and theological backgrounds occupy each category.

In our society, indeed throughout the world, the one issue that screams most loudly that the Bible is not accurate or relevant is evolution. Yet, church leaders who say they want to teach the Bible often ignore the issue, either out of a lack of interest, understanding, confidence, or courage. How sad, because the scientific case for creation and the flood is so compelling—and fatal to evolution.

Most Christians feel the responsibility to evangelize—to take seriously the great commission. What are the major obstacles to evangelism? People give many reasons for rejecting Christ:

- ◆ Christians are hypocrites, judgmental, dogmatic, legalistic, and out of touch with reality.
- ◆ My past misdeeds could never be forgiven.
- ◆ I prefer to live without biblical constraints.
- ◆ I am too busy to consider the matter.
- ◆ I prefer another religion.
- ◆ Evolution proves that the Bible is wrong.
- ◆ There is no God—and therefore, no moral absolutes.
- ◆ A loving God would not allow the suffering and evil we see in the world.
- ◆ The Bible is outdated; it contains myths and errors.

A correct understanding of origins overcomes several of these objections directly. Other objections result primarily from a lack of confidence in or understanding of the Bible. For those who do not believe the Bible is accurate, it does little good to say, “Believe because the Bible says so!” What better way to establish the remarkable accuracy and authority of Scripture than by showing that Genesis 1–11 (the most discredited portion of the Bible to the secular world) is scientifically accurate and is real history involving real people—our not-so-distant ancestors. The Bible comes alive. Ignoring the origins issue leaves evolution, a major stumbling block to many, unopposed. For the church, evolution is like an elephant that has occupied the church’s living room for over a century. Instead of accommodating the beast, why not remove it?

Some theologians are uncomfortable with science and the subject of origins. They know what the Bible clearly says, but may not know (or want to know) the scientific evidence that is so consistent with a literal creation and a

global flood. Therefore, they—spooked by science—avoid the subject, which leaves their congregations and students in the dark. As Ralph Waldo Emerson wrote: *“The religion that is afraid of science dishonors God and commits suicide.”*

When speaking to the Jews, all of whom knew there was a Creator, the Apostle Paul could begin with Jesus Christ and the gospel. However, when speaking to Greek pagans, Paul first had to explain that there is a Creator (Acts 14:15, 17:24–28). Because we live in increasingly pagan societies with growing moral decay—all seemingly consistent with evolution and survival of the fittest—helping others recognize the Creator seems to be a logical first step in bringing them to Christ. But Christ was more direct. When confronting some of the religious leaders, Jesus said in John 5:46–47,

For if you believed Moses, you would believe Me; for he wrote of Me. But if you do not believe his writings, how will you believe my words?

What did Moses compile that has been so widely rejected for the last 150 years? Genesis 1–11, the most ridiculed—and to many Christians—embarrassing portion of the Bible. Elsewhere (John 1:3, Colossians 1:16) we are told that Christ was there in the beginning and *“all things have been created through Him and for Him.”* Also, Genesis 3:15 gave us the first hint of Christ and His work of salvation.

God reveals Himself in two ways: by special revelation (the Scriptures) and general revelation (all that He created). How tragic that a false interpretation of general revelation (evolution), now taught throughout the world, is used to discredit special revelation. Correct teaching can reverse this.

For the first half of my life, I held Position 1. During the next few years, I shifted to Position 2, then to Position 5. Christians are in all five positions. Where are you?

How Can the Study of Creation Be Scientific?

Let me define science.

science: *A field of study, using observations and experiments, to better understand natural phenomena.*

Broad, but increasingly precise and concise, relationships (usually mathematical) are sought between causes and effects. These relationships, called *scientific laws*, help predict future phenomena and explain past events.

Notice, this does not mean that *the first cause* must be naturalistic. It is poor logic to say that because science deals with natural, cause-and-effect relationships, the first cause must be a natural event. Furthermore, if the first cause were a natural consequence of something else, it would not be the first cause. An infinite series of events would have preceded it—with no first cause. Scientific laws can give great insight on ultimate origins although the first cause cannot, by definition, be duplicated. Yes, there was a *miraculous* beginning. [See Items 53 and 55 on page 31.]

Scientific conclusions, while never final, must be based on evidence.

scientific evidence: *Verifiable measurements or observations that support or oppose possible physical explanations.*

All evidence in Parts I and II of this book is based on observable, natural phenomena that others can check. (This book also contains 58 testable and potentially falsifiable predictions.) To most people, this evidence implies a creation and a global flood. This does not mean that the Creator (The First Cause) can be studied scientifically or that the Bible should be read in public-school science classes. (I have always opposed that.) Those who want evolution taught without the clear evidence opposing it, in effect, wish to censor a large body of scientific evidence from schools. That is wrong. Also, the consequences of a global flood have been misinterpreted as evidence for evolution, not as evidence for a flood. That misinterpretation, unfortunately, is taught as science. [See Part II.]

Explanations other than creation or a global flood may someday be proposed that are (1) consistent with all that evidence and (2) demonstrable by repeatable, cause-and-effect relationships. Until that happens, those who ignore known evidence are being quite unscientific. Evolutionists' refusal to debate this subject (see pages 570–571) and their speculations on cause-and-effect phenomena that cannot be demonstrated also show poor science, especially when so much evidence opposes those speculations.

Evolutionists raise several objections. Some say, “Although evidence may imply a sudden beginning, creation is supernatural (not natural) and cannot be entertained as a scientific explanation.” Of course, no one understands *scientifically* how the universe came into existence—how space, time, matter, and the laws of physics began. [See

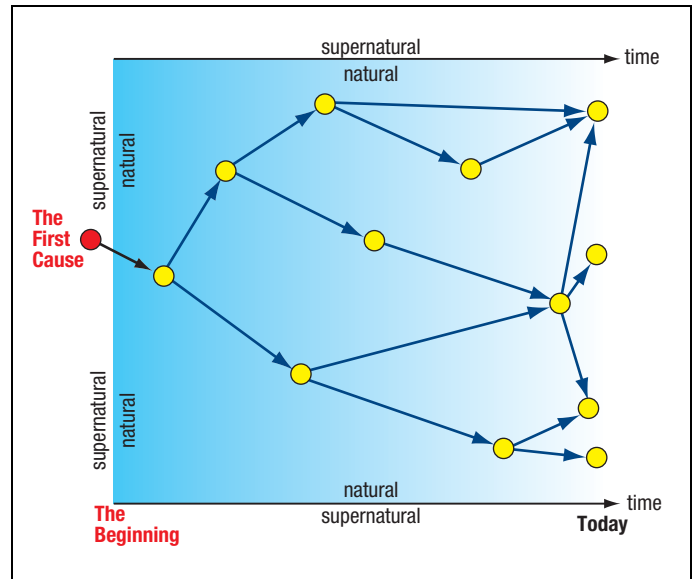

Figure 225: Causes and Effects. Each arrow’s tail represents a cause, and each yellow circle represents an effect. The arrow itself is the cause-to-effect relationship. Yellow circles also represent scientific evidence that to most people suggests a creation and a global flood. All of us, including students, should be free to reach our own conclusions about origins after learning the evidence and all reasonable explanations. Withholding that information in schools and misrepresenting it in the media are inexcusable.

The first cause appears to be supernatural, or beyond the natural (blue area). Evolutionists often say that the yellow circles and their scientific implications cannot be presented in science classrooms, because the first cause (red circle) is supernatural. Subjects outside the natural (including biblical descriptions of creation and the flood that are so consistent with the physical evidence) are inappropriate for publicly financed science education. However, excluding what is observable and verifiable in nature, along with possible causes, is bad science, misleading, and censorship. Creation science, then, is the study of this scientific evidence.

Figure 253 on page 550 and the paragraph preceding that figure.] Others, not disputing that the flood best explains many features on Earth, object to a global flood, because the Bible—a document they may reject—speaks of such a flood. Still others object to the starting point for the flood (given on page 124), but in science, all starting points are possibilities. The key question must always be, “What best explains all the evidence?”

Also, the source of a scientific idea does not need to be scientifically derived. For example, Friedrich Kekulé discovered the ring structure of benzene in a dream in which a snake grabbed its tail. Kekulé’s discovery laid the basis for structural chemistry. Again, what is important is not the source of an idea, but whether all evidence supports it better than any other explanation. Science, after all, is a search for truth about how the physical universe behaves. Therefore, let’s teach all the science.

Why Is the Universe Expanding?

To answer this question, we will first look briefly at some relevant Scriptures. Then we will examine specific scientific evidence and compare two possible explanations.

At least 11 times, the Bible says that God “stretched out” or “stretches out” the heavens. [See Table 25.] Is Hubble’s law (soon to be explained) a consequence of this stretching? Does this mean that space is elastic? In a few pages, we will have the answers.¹ Key ideas in the Bible are often repeated for emphasis. Therefore, even if we have difficulty visualizing this stretching, we can be confident of its significance.

Table 25. Bible References to Stretching Out of the Heavens

Job 9:8	“[God] stretches out the heavens”
Ps 104:2	“stretching out heaven like a tent curtain” ¹
Is 40:22	“He ... stretches out the heavens like a curtain and spreads them out like a tent” ¹
Is 42:5	“... God the Lord, who created the heavens and stretched them out”
Is 44:24	“I, the Lord, am the maker of all things, stretching out the heavens by Myself”
Is 45:12	“It is I who made the earth and created man upon it. I stretched out the heavens with My hands”
Is 48:13	“Surely My hand founded the earth and My right hand spread out the heavens.”
Is 51:13	“... the Lord your Maker, Who stretched out the heavens and laid the foundations of the earth”
Jer 10:12	“He has stretched out the heavens”
Jer 51:15	“He stretched out the heavens”
Zech 12:1	“the Lord who stretches out the heavens”

The context of each of the above verses deals with creation. Although past and present tenses (stretched and stretches) are expressed in these English translations, Hebrew verbs do not generally convey past, present, or future. Translators must rely on context and other clues to determine tense.

For example: creation was completed in six days (Exodus 20:11), but on Day 4 of the creation week, the stretching produced separate stars (Genesis 1:16). Today (in the present), we see these stars as they appeared in the past. Because of this past stretching of space, stars are now redshifted and at extreme distances.

The Hebrew word for stretched is *natah*. It does not mean an explosion, a flinging out, or the type of stretching that encounters increasing resistance, as with a spring. *Natah* is more like the effortless reaching out of one’s hand.

Expansion: Big Bang or Big Stretch?

The stretching explanation, proposed here, has similarities and differences with the big bang theory. [See Table 26.] Both the big bang and stretching explanations describe a very rapid expansion of the universe soon after time began, but before the laws of physics were in place. As one big

Table 26. Comparison of Two Explanations for Expansion of the Universe²

		Big Bang (Inflation)	Big Stretch (Creation ²)
SIMILARITIES	The universe and time began before the laws of physics came into operation. ³ Energy and matter appeared out of nothing. ⁴	Yes	Yes
	Space expanded in all directions faster than the speed of light. Wave lengths of light were stretched (redshifted). Stars and galaxies were carried outward by expanding space.	Yes	Yes
DIFFERENCES	When did the expansion occur	At the very beginning	Just before all matter gravitationally merged
	When time began, the mass of the universe was what it is today, but it was all concentrated in a	point, one quadrillionth the size of an atom.	volume, that was several light-days in radius.
	What expanded?	space, light, and matter	space (the heavens) and light
	Expansion occurred	within a fraction (10 ⁻³²) of a second after time began	on Day 4 of Creation Week
	After the accelerated expansion, the universe was	the size of a basketball, but the outward momentum has continued for 13.7-billion years	nearly the size it is today
	Expansion energy came from	inside the universe	outside the universe
	The earliest universe was filled with	only hydrogen, helium, and lithium; half was matter, and half was antimatter	only matter, including most of today’s chemical elements
	Stars, galaxies, planets, and black holes began forming	after 420,000,000 years of expansion ⁵	before the expansion, only a few thousand years ago
	The initial temperature was	nearly infinite	finite
	Some materials, if they once exceed certain temperatures, will never take the form we see them in today. Therefore, temperatures were never “nearly infinite.” ⁶		

bang authority, Andrei Linde, stated:

In its standard form, the big bang theory maintains that the universe was born about 15-billion years ago from a cosmological singularity—a state in which the temperature and density are infinitely high. Of course, one cannot really speak in physical terms about these quantities as being infinite. One usually assumes that the current laws of physics did not apply [during the big bang’s rapid expansion—called inflation²]. ... One may wonder, What came before? If space-time did not exist then, how could everything appear from nothing? What arose first: the universe or the laws determining its

*evolution? Explaining this initial singularity—where and when it all began—still remains the most intractable problem of modern cosmology.*³ [emphasis added]

The stretching proposal, in contrast to the big bang theory, does not begin with a singularity—an infinitesimal point (a mathematical fiction).⁷ Nor does the energy expended in stretching out the heavens mysteriously come from within the universe or during its first trillionth of a trillionth of a ten-billionth of a second (10^{-32} second), as with the big bang theory. Energy flowed *into* the universe as stretching progressed. According to the big bang theory, stars, galaxies, and black holes began forming after 420,000,000 years. According to the stretching explanation, *these bodies were present near the beginning of time—early in the creation week.* You can decide which explanation the following, surprising evidence supports.

The Evidence

Slowly Spinning Sun. Our sun spins slowly, about once every 25 days (depending to some extent on latitude). If, as evolutionists teach, our sun and planets formed from a large spinning dust and gas cloud, its spin rate today should be a hundred times faster. This is required by the law of the conservation of angular momentum. A common demonstration of this law is shown in Figure 84 on page 154. [Also see “**Angular Momentum**” on page 27, and “**Star Births? Stellar Evolution**” on pages 34 and 95.]

*As a result of this effect [the law of the conservation of angular momentum] the sun should now be spinning on its axis at the rate of once every few hours. Actually, it turns at a far slower rate, 100 times less rapid. What has slowed the sun down? A thoroughly satisfactory answer has never been provided.*⁸

However, if the sun formed before space was stretched out, its slow spin rate today would not be unusual.

Star Formation. Astronomers recognize that the densest gas cloud seen in the universe today would have to be thousands of times more compact to form stars by gravitational collapse. [See “**Star Births? Stellar Evolution?**” on page 95.] According to the big bang theory, stars began to form by the gravitational collapse of spinning dust and gas clouds 420-million years after the big bang’s sudden inflation. Astronomer Martin Harwit, former director of the National Air and Space Museum in Washington, D. C., points out that if this were true, the vast energy, angular momentum, and magnetic fields generated by each collapse would be clearly visible—but they are not. [See “**Interstellar Gas**” on page 95.]

The stretching explanation states that the volume of the universe was much smaller when stars were made. The stretching of space would have given stars the large orbital energy and angular momentum we see. After stretching, we would not expect to see vast amounts of heat, extreme

rotational velocities, or gigantic magnetic fields that a collapse of a giant spinning dust cloud would produce.

Binary Stars. “*At least half of stars like the Sun are found in multiple systems. And yet the origins of this all-too-normal population are mysterious*”⁹—unless one considers the stretching explanation. For example, the closest stars to our Sun are two stars that orbit each other: the Alpha Centauri system. Three- and four-star systems are also found.¹⁰

Based on the stretching explanation, this is expected, since all stars were initially concentrated within a much smaller volume. Their close proximity to each other allowed the closest pairs, triplets, and quadruplets to become gravitationally coupled—tightly enough to remain coupled during the stretching—days later. Had each star formed from a large spinning dust and gas cloud, as the big bang proposes, pairs could only have formed if one star captured another. Considering the great distances separating stars today, such captures would be highly improbable.

Planet Formation. So many planets have been found outside our solar system that there appear to be about as many planets as there are stars. Many orbits of these planets show that they could not have evolved in any conceivable way.

*With so little in common with the familiar Solar System planets, these newcomers [extrasolar planets] spell the end for established theories of planet formation.*¹¹

For example, more than 30 sets of binary stars (two stars orbiting their common center of mass) have one or more planets orbiting each star.¹² The rapidly changing gravity fields produced by each binary star would have prevented any orbiting cloud of dust and gas from collapsing into one planet. This was recognized before these planets were discovered.

*The environment around a pair of stars, [researchers] argued, would be too chaotic for planets to form.*¹³

If planets formed around binary stars millions of years ago, they would have been so unstable that we would never see them today. But we do!

*Even if a planet could form in such a dynamic environment, its long-term stability would not be assured—the planet would wind up being ejected into deep space or crashing into one of the stars.*¹³

Now that planets are often found around binary stars (an unstable situation), it is clear that the planets are young, and they must have formed at about the same time as their binary stars. This contradicts the big bang explanation that stars and planets formed over millions of years from large rotating clouds of dust and gas.

However, in a much smaller universe, both planets and stars could have come into existence at about the same time. First, large clusters of mass would have formed stars and smaller clusters would have formed planets, each moving, because gravity was pulling all matter together. Therefore each would have small amounts of rotational

angular momentum. Then, before all matter in this smaller universe collapsed into one massive black hole, the space between these bodies was stretched out, giving each body the great rotational angular momentum we see today.

Hot Jupiters. Leslie Sage, an authority on exoplanets (planets outside our Solar System), was perplexed when he learned about *hot Jupiters*—Jupiter-size planets orbiting so close to their stars that they complete an orbit every few days. Sage explained:

*How could a planet be so close to its parent star—it seemed very unlikely that it could form there—and was such a planet stable against evaporation by stellar radiation?*¹⁴

From his way of thinking, hundreds of millions of years after the big bang, stars formed in swirling and contracting disks of gas and dust. Millions of years later, the remaining gas and dust orbiting the new star contracted to form planets. However, Sage knew that dust orbiting too close to a star could not merge to become a planet. (Particles trying to merge on the side of a growing planet closest to the star would feel a much greater gravitational pull from the star than merging particles on the far side of the planet; those tidal forces would pull a growing planet apart. Sage also knew that dust swirling that near the star would absorb so much heat over those millions of years that the dust would vaporize into the vacuum of space, so no planet would form,¹⁵ especially a Jupiter-size planet.

Unlike all the planets in our Solar System, many hot Jupiters are orbiting retrograde,¹⁶¹⁷ How can that be?

What are astronomers (and Leslie Sage) missing? The early universe was much smaller and contained solid bodies, not a superhot plasma that might become dust million of years later. Therefore, the gravitational sphere of influence of each solid body encompassed many more solid bodies. [See “**Sphere of Influence**” on page 303.] As stars and planets grew, their spheres’ of influence grew rapidly, so run-away merging occurred simultaneously for both growing stars and nearby planets. A planet’s amount of dust orbiting a star absorbs billions of time more heat than a solid planet having the same mass and at the same distance from the star, because the dust has a total surface area that is billions of times greater. Since a star and its planets were never part of a single swirling gas and dust cloud spinning around the same axis, there is no reason for hot Jupiters to have their spin axes aligned with the star’s spin axis, or for all their orbits to be prograde.

If a big bang occurred, a large spinning disk or cloud must precede the formation of solid or large orbiting bodies. But as we saw with the “**Slowly Spinning Sun**” and “**Star Formation**” on page 440, going through that spinning-disk stage would not have produced many features we see today. From the stretching perspective, both large and solid orbiting bodies formed within days—but not from a large spinning cloud. No contradictions arise.

Intergalactic Medium (IGM). Outer space is nearly a perfect vacuum. The IGM (the vast space between galaxies) contains about 10–100 hydrogen atoms per cubic meter. However, almost every hydrogen atom in the IGM, out to the farthest galaxies telescopes can see (13 billion light-years away), has been *ionized*—has lost its electron.

According to the big bang theory, for the first 380,000 years after the big bang, the expanding universe was so hot that all matter was ionized. Only after the universe had expanded (and cooled) enough, could a proton (positively charged) hang on to an electron (negatively charged) and become neutral hydrogen (no electrical charge). Then, with matter no longer ionized, positive hydrogen ions would not repel each other, so stars and galaxies began to evolve, and light was no longer scattered. (Reasons why stars and galaxies could not have evolved are given on pages 32–36.)

This presents a major problem for the big bang theory. What reionized the hydrogen that today pervades the IGM? No explanation has been found.¹⁸ Most big bang theorists assumed that radiation from the earliest stars and galaxies—after the universe had already expanded for hundreds of millions of years—was powerful enough to reionize the IGM. This now appears to be implausible.¹⁹

According to the stretching explanation, the universe was extremely compact at creation, so the intense light of Day 1 (explained on page 442) ionized the surrounding gases. Then, the heavens were stretched out. Therefore, hydrogen in the IGM has always been ionized, just as it is today.



PREDICTION 55: Billion-dollar telescopes, now being built, will be able to see further back in time—much closer to the beginning of the universe. They will not find the IGM being ionized, because it has been ionized since the creation.

Black Holes. Black holes come in two varieties: massive black holes (MBHs) and stellar black holes (SBHs). MBHs are millions to 21 billion times more massive than the Sun. *They lie at the center of every large galaxy near enough to be studied—and perhaps every galaxy.*²⁰ (Later, the very important reason for this will be explained.) SBHs are only a few tens of times heavier than the Sun. If our Milky Way Galaxy is as old as evolutionists believe, tens of millions of stars heavier than ten solar masses should have collapsed into SBHs.²¹ However, our galaxy has only about 50 known SBHs—so our galaxy may be young. In both types of black holes, mass is so concentrated that nothing within a specific distance of a black hole, called the *event horizon*, can escape its gravity—not even light.

Astronomers admit that galaxies²² and black holes²³ must have existed very soon after the universe began, but the big bang theory says that 380,000 years after the big bang (before stars formed) all matter was spread out with almost perfect uniformity. [See Figure 227.] That uniformity

Quasars and Light, the Eddington Limit, Galaxies and Stars, Angular Momentum, and Gravity Waves

Quasars and Light. Quasars, discovered in 1963, are extremely distant massive black holes (MBHs) whose gravity pulls in immense amounts of nearby matter.²⁴ The potential energy of all that infalling matter is converted to bright radiation, making quasars the most luminous stable objects in the universe. Because quasars are so far away (yet so bright), we see them as they were in the distant past, pulling in enormous amounts of matter. But contrary to the big bang theory, that matter is enriched with heavy metals.²⁵ Black holes that are much closer to us, are also closer to us in time, so they have already pulled in all nearby matter. Therefore, they are not emitting light from infalling matter and are no longer quasars.

We can see more than 200,000 quasars. A few “emit as much light and energy as thousands of giant galaxies concentrated in a region as tiny as the solar system.”²⁶ The average quasar consumes the mass equivalent of 10 stars per year. No doubt this consumption rate has been decreasing since time began. Is it more likely that this has been going on for billions or thousands of years?

One quasar, two billion times the mass of the Sun, is so far from Earth that believers in the big bang admit that the quasar must have formed (by some unknown mechanism) very soon after the universe began. This contradicts their teaching that the universe began with a superhot expansion, and 420,000,000 years later, stars began forming.²³

“It is safe to say that the existence of this quasar will be giving some theorists sleepless nights.”²⁶

Here is what apparently happened on Day 1, when God said, “Let there be light.” (Genesis 1:3)

Hours after the universe was created (and before the universe was stretched out), so many quasars were near us that unimaginable amounts of light were emitted. If so, has there ever been an event as dramatic and brilliant that was brought forth so quickly and effortlessly with such few words?

The Eddington Limit. Since we see quasars at such extreme distances, they had to form soon after the universe began. But could quasars (such as the extremely bright quasar mentioned above) grow fast enough to reach their massive size that early? The faster quasars grow, the more radiation they emit, which, in turn, slows the infalling matter and their growth rate. This “speed limit” is called the *Eddington radiation limit*. However, just as a fan can more easily blow away falling gas and dust than falling rocks, the Eddington limit would not apply to the early, more compact universe in which clumped matter fell in toward the black hole. The big bang requires matter smaller than dust to fall into black holes and quasars. It would not.

Galaxies and Stars. Days after all this clumping, the universe was stretched out. Stars gripped by each MBH’s gravity and held within its sphere of influence, became a galactic bulge. Surrounding each galactic bulge was a

stretched galaxy containing typically billions of widely spaced stars. Thus, all galaxies that can be examined contain a central MBH! Had the stars nearest Earth not been spread out, life on Earth would not exist.

On Day 4, “He made the stars also.” (Genesis 1:16)

Again, concise and profound. Had stretching not happened, all matter would have collapsed into one super-massive black hole, and we would not be here to discuss it.

Angular Momentum. Nineteen MBHs spin so fast that their surfaces travel at 50–99% of the speed of light.²⁷ (If Earth spun at the speed of light, a day would be 1/7th of a second long.) For MBHs to achieve such high spin rates, staggering amounts of matter with large amounts of angular momentum must have been pulled into each of these MBHs *soon after the universe began, but before the universe was stretched out.*

However the big bang theory claims that all matter in the universe came from a primordial “egg” *one hundred billion times smaller than a proton.*⁷ With a radius of almost zero, that “egg’s” angular momentum would be almost zero—even if its surface had been spinning at the maximum possible speed—the speed of light. Therefore, the net angular momentum of the universe today (according to the law of the conservation of angular momentum) would still be almost zero. Instead, the stretching of the universe gave the universe its gigantic angular momentum!

For the skater shown in Figure 84 on page 154, to reach her high spin rate, she first had to stretch her arms outward while spinning at a moderate rate. Then, by pulling her arms tightly inward, she became a blur. *The big bang theory does not explain the gigantic amount of angular momentum in the universe, but the stretching explanation does.*²⁸

Gravity Waves. Gravity waves, emitted by black holes that collided far away and in the distant past, are now reaching Earth.²⁹ From their beginning, black holes orbited their mutual centers of gravity, each sending out—at the speed of light—one gravity wave per orbit. According to Einstein’s theory of general relativity, those waves stretched and compressed space. (*Yes, space is elastic, as 9 verses in Table 25 suggest.*) That removed energy from each orbit, so the black holes slowly spiraled inward and eventually collided. Billion dollar instruments at Hanford, Washington, Livingston, Louisiana, and Pisa, Italy detected one of these collisions 11 minutes and 58.6 seconds after 5 A.M. (EST) on 4 January 2017. Simulations showed that had that black hole pair been spiraling inward for 13.7- billion years (the age evolutionists claim for the universe), they must have started only 0.2 of an astronomical unit apart.³⁰ They would have been even closer if the universe is younger. Therefore, those monsters, with a total mass 50 times that of the Sun, formed in an extremely dense compact universe—exactly as postulated by the stretching explanation, but something a big bang would not produce.³¹

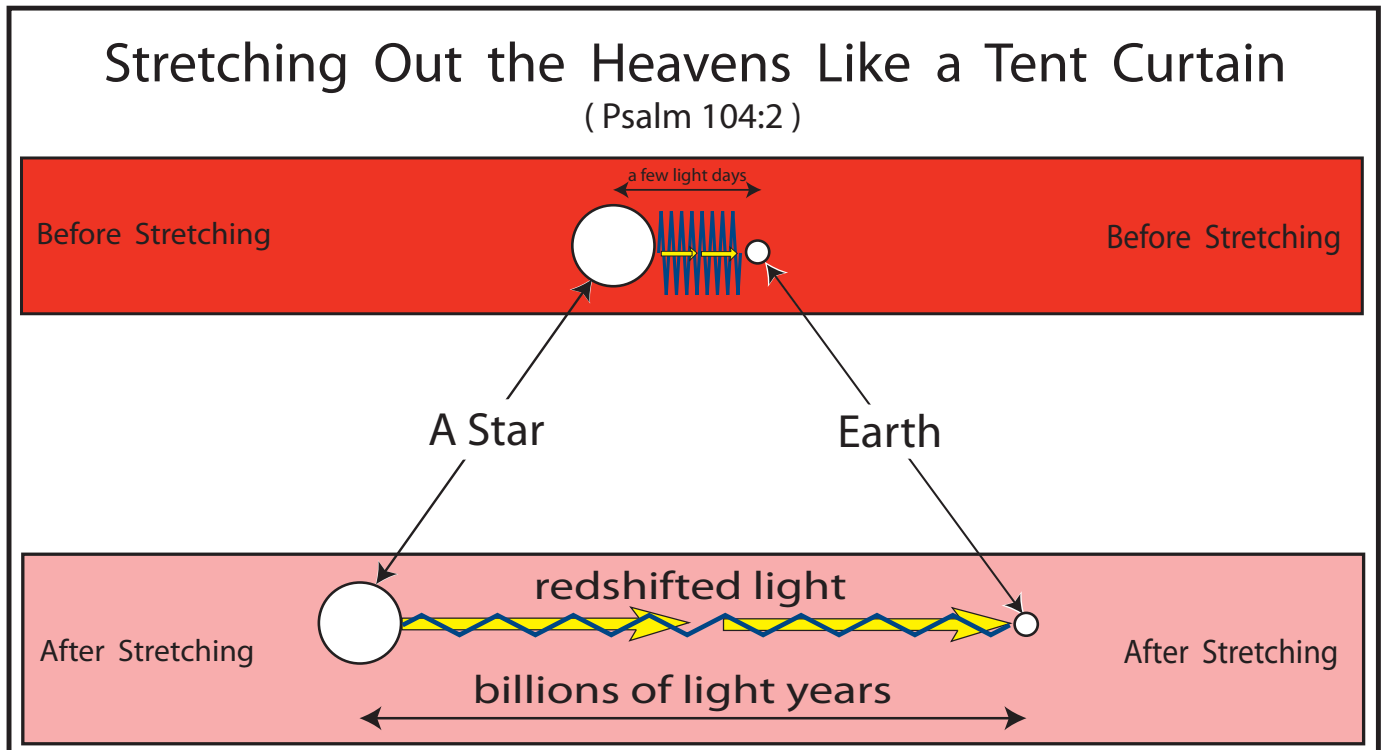

Figure 226: Stretching Out Light. Huge amounts of energy were required to stretch out the heavens—in effect, to lift massive gravitational bodies and move them billions of light-years away from other gravitational bodies. The same energy source that stretched out space (represented above by the blue springs) also stretched out—redshifted—light (represented by the yellow arrows). The law of conservation of energy says that energy cannot be created or destroyed *in an isolated system*. According to the big bang theory, the universe is an isolated system, so that energy could not have come from within the universe, as the big bang theory claims. Instead, it came from outside the universe. **Thus, we can see distant stars and galaxies in a young universe.**

“The horizon problem” has perplexed advocates of the big bang theory for decades, because they see no way that opposite sides of the universe, which are so far apart today, could ever have interacted with each other—even at the speed of light. Nevertheless they do have the same temperature and other physical properties. Stretching explains this, because all matter was initially confined to a volume only a few light-days in diameter. Therefore, temperatures throughout that small volume reached equilibrium before the stretching began, on Day 4 of the creation week.

would prevent gravity from forming galaxies and black holes, even over the supposed age of the universe.³² However, black holes would easily form soon after the creation of all matter in a much smaller, lumpier universe. Then, before all mass collapsed into one huge black hole, space was stretched out.

Standard cosmological models [the big bang and its variations] implied that matter in the universe was not concentrated tightly enough to have formed black holes so early on. Clearly the models were wrong.³³

Jets are often seen traveling away from black holes and along their spin axis—some at “up to 99.98 percent of the velocity of light. These amazing outflows traverse distances larger than galaxies”³⁴ and are powered by the gigantic magnetic field generated by the spinning disk of matter spiraling in toward the event horizon.

Colliding Galaxies. Galaxies frequently contain two distinct rotating systems, as if a galaxy rotating one way collided with another rotating the opposite way. Because distances between galaxies are so vast today, such mergers were thought to be rare.³⁵ But the Hubble telescope, in its

furthest look back in time, has photographed dozens of galaxies in the process of colliding.³⁶ Obviously, galaxies formed quickly in the early, much more compact universe.

Also, some massive black holes (MBHs) orbit each other inside a galaxy, and four galaxies contain triple MBHs.³⁷ Astronomers believe galaxy mergings produced these systems, but as already stated, galaxies rarely merge today, because they are so far apart.

Does this mean that the universe is billions of years old? No. For one thing, if some galaxies merged billions of years ago, why haven’t the different rotations within merged galaxies become uniform rotations by now? Clearly, those mergings did not happen billions of years ago.³⁸

In fact, before the heavens were stretched out, galaxies were closer to each other, resulting in much greater speeds and frequent collisions. Likewise, much of the expansion of supernova remnants over great distances may be due to the stretching, not the passage of millions of years.

Galaxies and Their Black Holes. The mass of MBHs are positively correlated with several characteristics of each MBH’s galaxy: the galaxy’s mass, luminosity, the number of

associated globular clusters, and especially the mass of the galactic bulge. Typically, the larger the galaxy, the larger its black hole. According to standard explanations for galaxy formation, this should not be, because black holes are so small compared to the volume of galaxies today.

*For reasons not fully understood, it appears that the sizes of central black holes and the masses of their galaxies, especially the central bulges, are almost perfectly in step [perfectly correlated].*³⁹

Here's the problem for those who believe a big bang preceded the formation of black holes, stars, and galaxies: black holes are too small to affect something as huge as a galaxy that formed long after the universe expanded, and there is no reason a galaxy should form a large central black hole. Therefore, "the correlation means that the black hole and galaxy had to form together."⁴⁰ But how?

Before the universe was stretched out, the densest concentrations of matter began forming MBHs; less dense concentrations formed stars. But before all those stars surrounding the growing MBHs collapsed into the MBHs, space was stretched out, so the surrounding concentration of stars became galaxies—all which appear to contain a central MBHs. This is *inconsistent* with the big bang theory, but is consistent with the stretching theory.

*The black holes that power quasars probably started their lives in miniature and grew exponentially by accretion—whereby matter close to a black hole cannot escape the strong gravitational field and is ultimately pulled into the black hole. To have assembled such a huge mass so quickly, the bright quasars discovered in the early Universe are thought to have resided in regions that had a particularly high density of matter. Such an environment not only would have fueled the rapid growth of the black holes powering these quasars, but also would have spurred the growth of galaxies in the quasars' immediate vicinity.*⁴¹

Why would the correlation of the black hole's mass be even stronger for the mass of the galaxy's central bulge than the mass of the entire galaxy? The strength of gravity diminishes as the square of the distance between gravitating masses. Therefore, as the galaxy was stretched out, gravity's strength dropped faster for the outer portion of the galaxy than the inner portion, which produced the central bulge. (Without this understanding, central bulges are a mystery.)⁴²

To summarize this very important point, the universe was initially quite small. Some regions contained more mass than others. The densest concentrations collapsed rapidly, forming massive black holes. Before all nearby stars collapsed into growing black holes, space was stretched out, so nearby stars formed galaxies. The closest matter to the black hole became the central bulge. Thus each galaxy that can be seen clearly enough has at its center a MBH, so the masses of the MBH, galaxy and galactic bulge are highly correlated.

A few small galaxies have a huge MBH.⁴³ Possibly the

largest black hole known to be in the center of a small galaxy is 21 million times the mass of our sun! It lies in the compact galaxy NGC 1277, but has an event horizon five times the radius of our solar system!⁴⁴ What can explain this monster? Did enough time pass for a normal MBH to devour most of the stars in its galaxy? If so, we should see many examples of extremely large MBHs in small galaxies. Did multiple galaxies collide, merging several of their MBHs? As discussed above, galaxy collisions are statistically improbable in today's immense universe. However, in the smaller, early universe, some growing black holes and nearby stars might have merged before the heavens were stretched out leaving extremely large MBHs in small galaxies.⁴⁵

Central Stars. About 40 stars orbit within a few dozen light-hours of the black hole at the center of our Milky Way Galaxy. Those stars could never have evolved that close to a black hole, which has the mass of 4,300,000 suns, because the black hole's gravity would have prevented gas from collapsing to become a star.⁴⁶ However, those stars could have formed in a much denser environment, before space was stretched out during creation week.

*In principle, this [collapse] could have occurred if the density of the gases in the centre of the Galaxy was much higher in the past. Higher density would allow clumps in the clouds to collapse to form stars, even in the presence of a [black hole's] strong gravitational field.*⁴⁷

Some astronomers say that these stars evolved far from the black hole and then migrated great distances toward the black hole. Such a migration, which seemingly violates laws of physics,⁴⁸ must have been fast, because the stars are so massive that their lifetimes are very short in astronomical terms. Also, matter migrating toward black holes must radiate vast amounts of energy as happens with quasars, but that energy is not observed in any wavelength for these central stars.

Spiral Galaxies. If spiral galaxies formed billions of years ago, their arms should be wrapped more tightly around their centers than they are. Also, nearer galaxies should show much more "wrap" than more distant spiral galaxies. [See Figure 230 on page 455.] But, if space was recently stretched out, spiral galaxies could appear as they do.

Why are some galaxies spirals and other elliptical? Astronomers don't know,

*"It's hard, for example to tell why one [galaxy] turns into a graceful spiral but another evolves into a blob."*⁴⁹

It was a matter of timing. When the stretching occurred before a large group of stars collapsed, the galaxy was became spiral.

Strings of Galaxies. Long strings of hundreds of thousands of massive galaxies have been discovered.⁵⁰ Obviously, gravity would pull matter, not into long strings, but into spherical globs. Long strings of galaxies would develop if the universe was stretched out as galaxies began to form—much like pulling taffy into long strings. Many of these galaxies appear connected or aligned with other galaxies or quasars. [See "**Connected Galaxies**" on page 43.]

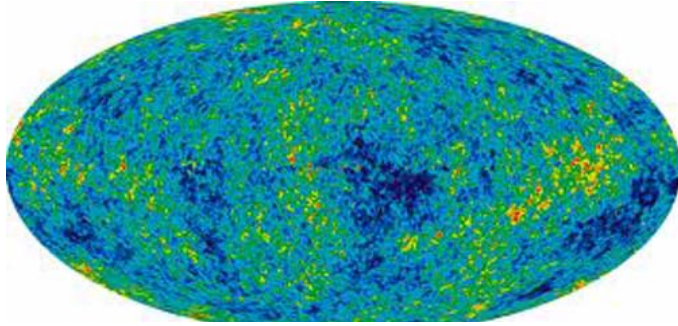

Figure 227: No Gravitational Waves. In 2001, the Wilkinson Microwave Anisotropy Probe (WMAP), a NASA spacecraft, began measuring the extremely uniform temperatures of the Microwave Background (CMB) radiation from deep space. The hot spots, shown in yellow and orange, are *only 1 part in 100,000 hotter than the dark blue spots*. Two interpretations are possible:

1. Big Bang Interpretation: For 13.7 billions years all the matter in the universe has moved rapidly away from the primordial “egg” (the point where the bang began). The early universe was filled with gravitational waves (distortions of space-time) that should be easily detected today in the CMB. But they are not found!

Unfortunately, the search for inflationary gravitational waves has not panned out. Although cosmologists first observed hot and cold spots with the COBE (COsmic Background Explorer) satellite in 1992 and with many subsequent experiments, including even more recent Planck satellite results from 2015, they have not found any signs of the cosmic gravitational waves expected from inflation, as of this writing, despite painstaking searches for them.⁵¹

2. Stretching Interpretation: These are early gravity-driven concentrations of matter (stars and even quasars⁵²) soon after the creation. All matter in the universe was created in a much smaller universe. Then on Day 4, space was stretched out. Gravity waves produced before the stretching were quickly dissipated in the smaller universe. However, during the stretching, matter—embedded in and carried along by the expanding space—did not move relative to the expanding space. Therefore, we should not expect to see gravity waves in the CMB. But we do see other particles produced before the stretching by the many impacts in the smaller universe: neutrinos, cosmic rays, and radiations at practically ever possible wave length. Those who believe in the big bang, see these products in the CMB but do not know how they were produced.⁵³

Dwarf Galaxies. Dwarf galaxies are sometimes embedded in a smoothly rotating disk of hydrogen gas that is much larger than the galaxy itself. [See Figure 228.] The mass (hidden or otherwise) of each dwarf galaxy is insufficient to pull the gas into its disk shape,⁵⁴ but if this matter was once highly concentrated and then the space it occupied was *recently* stretched out, those characteristics would be explained. [See Figure 226 on page 443.]

Distant Galaxies. Massive galaxies and galaxy clusters are found at such great distances that they must have formed soon after the universe began—exactly as the stretching explanation maintains. The big bang theory cannot explain how such distant and massive galaxy concentrations could have formed so quickly that their light had over 13.0-billion years to travel to planet Earth.^{5, 55, 56}

Furthermore, stars in the most distant galaxies contain heavy chemical elements.⁵⁶ Therefore, according to the big

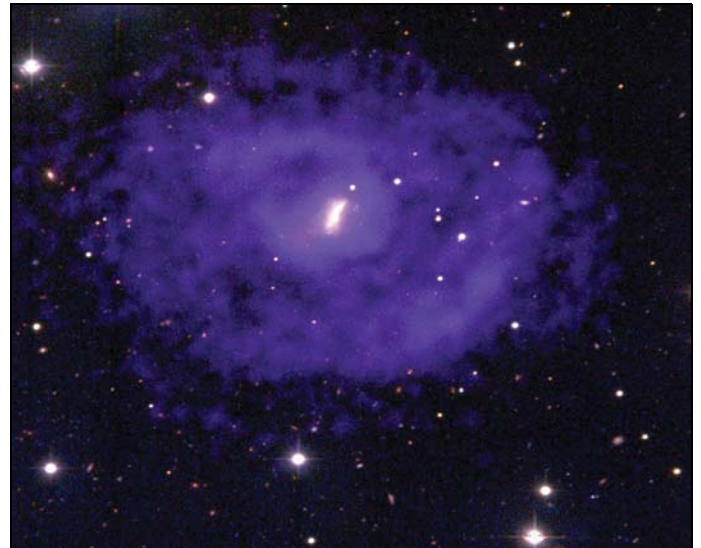

Figure 228: Dwarf Galaxy. An enormous hydrogen disk (blue) surrounds the dwarf galaxy UGC 5288 (bright white). This isolated galaxy, 16 million light-years from Earth, contains about 100,000 stars and is 1/25 the diameter of our Milky Way Galaxy, which has at least 100,000,000,000 stars. The dwarf’s mass is about 30 times too small to gravitationally hold onto the most distant hydrogen gas, so gravity could not have pulled the distant hydrogen gas into its disk. Because the gas is too evenly distributed and rotates so smoothly, it was not expelled from the galaxy or pulled out by a close encounter with another galaxy.

Before space was stretched out, gravitational forces and rotational velocities would have been much greater, so after the stretching, the hydrogen gas would have assumed this smooth, rapidly rotating pattern, even though the galaxy did not have the gravitational strength to hold the gas. This stretching must have occurred recently, because the gaseous disk has not dispersed into the vacuum of space. (The galaxy is seen in visible light; the hydrogen disk is seen by a fleet of 27 radio telescopes.)

bang theory, several generations of stars must have preceded those stars. That makes it even less likely all those time consuming events could have been completed and still have over 13,000,000,000 years for light to travel to Earth.

The stretching explanation says that during creation week, galaxies, galaxy clusters, and stars with heavy elements formed in a much smaller universe. Then the heavens were stretched out, producing today’s immense universe.

Starburst Galaxies. While we frequently see stars die, individual stars have never been seen forming. [See “**Star Births? Stellar Evolution?**” on page 34 and corresponding endnotes on page 95.] Therefore, evolutionist astronomers believe that star formation rates in our galaxy and nearby galaxies are too slow to be observed, but that amazingly high star formation rates occur in “starburst galaxies”—the brightest galaxies with the greatest redshifts. To achieve such ultrafast rates, those astronomers imagine 10-trillion solar masses of dark (invisible) matter were present.⁵⁷ Because those galaxies have high redshifts, they are extremely far away, so we see them far back in time, as they looked soon after the universe began. Because they are so bright, their stars must have all formed quickly.



Figure 229: Why are Galaxies Spinning?

“Galaxy rotation and how it got started is one of the great mysteries of astrophysics. In a Big Bang universe, linear motions are easy to explain: They result from the bang. But what started the rotary motions?”⁵⁸

Notice how the stretching of space spread the stars in spiral galaxies into the same pattern as a spinning lawn sprinkler spreads water droplets.

Both spiral galaxies and lawn sprinklers spin, but for different reasons. Spiral galaxies spin because gravity causes bodies in space to orbit more massive bodies that are nearby. A lawn sprinkler spins because of the jetting action of water squirting out of nozzles. In both spiral galaxies and lawn sprinklers, the spiral arms trail behind the direction of rotation.

Before the heavens were stretched out, those stars had high velocities, because they were near a galaxy’s center of mass where a black hole was growing. This is why a massive black hole appears to lie in the center of every large galaxy. Had the heavens not been stretched out, each growing black hole would have eventually consumed those stars. Instead of the awesome night sky we see, we would be living in a dark, forboding universe, and the *“the heavens would not be telling of the glory of God,”* contrary to what Ps 19:1 states. Abraham Lincoln famously noted, *“I can see how it might be possible for a man to look down upon the Earth and be an atheist, but I cannot conceive how a man could look up into the heavens and say there is no God.”*

As space was stretched out, light’s velocity remained unchanged, even though light’s wave lengths were stretched and, therefore, redshifted. Likewise, as space was stretched out, each star’s velocity (relative to space) remained unchanged while space’s expansion transported the stars radially outward.

Astronomers don’t understand this. Since the 1980s, they have imagined that these galaxies must contain some invisible substance (they call “dark matter”) which causes the outer stars to travel faster than the laws of physics would allow with the observed galaxy’s mass. Millions of dollars have been wasted in experiments trying to discover dark matter. Believing in dark matter simply reflects ignorance.^{59,60}

Physicists are growing ever more frustrated in their hunt for dark matter—the massive but hard-to-detect substance that is thought to comprise 85% of the material Universe. Teams working with the world’s most sensitive dark-matter detectors report that they have failed to find the particles, and that the ongoing drought has challenged theorists’ prevailing views.⁶¹

Their frustration will increase, until they understand how the universe began.

Actually, there is nothing unusual about those galaxies; we just are seeing them far back in time, as they appeared soon after they were created, but soon after the universe was stretched out. According to the big bang theory, stars could not form, until after 420,000,000 years, because all matter in the universe would have been spread out too uniformly—and dark matter would be needed (matter

that doesn’t exist, except in some people’s minds).

Stellar Generations. According to the big bang theory, there are three generations of stars, each with increasing amounts of heavy elements. The first generation should contain only hydrogen, helium, and a trace of lithium—the only chemical elements a big bang could produce. Millions of years later, second-generation stars would begin forming with heavier elements supposedly made inside first-generation stars that finally exploded. If so, some first-generation stars should still be visible, but not one has ever been found. [See Endnote 56n on page 93.] Actually, the most distant stars, galaxies, and quasars that can be analyzed contain some of these heavy chemical elements.²⁵

Matter and Antimatter. Albert Einstein explained why matter and energy are interchangeable. For example, energy can produce matter, but when it does, it always produces equal amounts of antimatter. If the big bang produced the universe, half the matter in the universe should be antimatter. However, the universe has almost no antimatter. Therefore, the big bang did not produce the universe—or half the universe disappeared. [See *“Antimatter”* on page 33 and related endnotes.]

Helium-2 Nebulas. Clouds of glowing, blue gas, called *helium-2 nebulas*, have been set aglow by something hot enough to strip two electrons from each helium atom. No known star—young or old—is hot enough to do that,⁶² but the compressed, “pre-stretched” universe, filled with blazing quasars, would be.

Stellar Velocities. Stars in the outer parts of spiral galaxies travel much faster than they would if they were in equilibrium. Therefore, these galaxies are flying apart. We cannot see that directly, because they are so far away and have been flying apart for only a few thousand years—since the stretching during creation week. [See Figure 229.]

Those stars got their higher velocities before space was stretched out—when they were nearer the center of their galaxy, where the galaxy’s gravity was much more powerful. Stretching did not remove those speeds. Appeals to so-called *dark matter*, which has never been seen or measured, is not needed to explain those high velocities. Dark matter is a fiction, created by astronomers wedded to the big bang theory.

Speeding Galaxies. Galaxies in galaxy clusters are also traveling much faster than they should, based on their distances from their clusters’ centers of mass. They too are flying apart, because the volume of space containing those clusters was stretched out.

The Flatness Problem. R. H. Dicke first explained the flatness problem in his 1969 Jayne Lecture, which was later published in “Gravitation and the Universe” for the *American Philosophical Society of Philadelphia* in 1970. The density of the universe, as shown in Equation (4) on page 447, had to be fine tuned to one part in 10^{62} . Had the universe been slightly denser by one part in 10^{62} , the expansion would have slowed and collapsed back on itself in a “big crunch” after 13.7-billion years (today’s age of the universe according to the big

The Universe's Expansion Energy

This standard derivation of Friedmann's equation—Equation (4)—is not controversial, but when comparing the big bang and stretching explanations, its implications are surprising and insightful. Assume that the early universe had a uniform density, ρ . Therefore, every sphere of radius R contained a mass M .

$$M = \frac{4\pi}{3} \rho R^3 \quad (1)$$

According to Hubble's law, an observer anywhere in the universe would see all distant galaxies moving away from him at a rate proportional to each galaxy's distance, R . The faster the galaxy is receding, the more its light is redshifted.

$$\begin{array}{l} \text{A Galaxy's} \\ \text{Recessional} \\ \text{Velocity} \end{array} = \frac{dR}{dt} \equiv \dot{R} = HR \quad (2)$$

where \dot{R} is shorthand for the galaxy's recessional velocity (the derivative of R with respect to time, t), and H is the Hubble constant. **Notice that Hubble's law is a consequence of stretching.**¹ In other words, Edwin Hubble (or you or I) could have come up with Hubble's law by only knowing that the universe was stretched out. Solving Equation (2) gives

$$R = R_0 e^{H \Delta t} \quad (3)$$

Because H is positive, Equation (3) says that for a brief time interval, Δt , the universe expanded exponentially from an initial radius R_0 . During this accelerated expansion, space and all light was stretched out (redshifted). Both the big bang and stretching explanations agree with the above. However, big bang proponents extrapolate the observed expansion all the way back to a time when all matter *and space* would have been concentrated at an infinitesimal point. This is how they arrived at their age of the universe.⁶³ They also do that so every particle in the universe interacts with every other particle, thereby solving the horizon problem, explained in Figure 226 on page 443.

In contrast, the stretching explanation says that the initial universe was compact, with a radius, R_0 , of several light-days. That was large enough to hold all the mass now in the universe, but small enough for light from millions of sources to travel back and forth several times throughout the universe. That solves the horizon problem and explains why the cosmic microwave background radiation contains black-body radiation. [See page 460.] Then for a brief time period, Δt , on Day 4, the heavens were stretched out. Was R_0 infinitesimal or finite (several light-days)?

If R_0 had been essentially infinitesimal, as with the big bang explanation, the temperatures and energy required for the expansion would have to be infinitely greater than those for the stretching explanation—and therefore, completely unreasonable! That alone falsifies the big bang explanation.

Since the expansion ended, the sum of the kinetic and potential energies of each particle in the smoothly expanding universe has remained remarkably close to zero.⁶⁴

$$\text{Energy} = \frac{1}{2} m \left(\frac{dR}{dt} \right)^2 - G \frac{Mm}{R} \approx 0 \quad t > \Delta t$$

where G is the gravitational constant, m is the mass of a particle on a sphere (whose radius is R and mass is M) at the center of mass of the universe. Therefore,

$$\dot{R}^2 \approx \frac{2GM}{R}$$

Yes, this implies that the universe has a center, is finite, and has a boundary.⁶⁵ Substituting Equations (1) and (2) in the above gives Friedmann's equation, namely

$$\left(\frac{\dot{R}}{R} \right)^2 = H^2 \approx \frac{8\pi}{3} G \rho \quad (4)$$

H and G are constants, so ρ is a constant. In Friedmann's equation, ρ is called the *energy density*, because mass and energy are interchangeable according to Einstein's famous equation $E = Mc^2$.

Equation (4) exposes a huge problem for the big bang, namely, *the flatness problem*, explained on page 446. Also, since ρ was constant during the accelerated expansion, the energy within every expanding sphere (centered at the center of the universe) increased as R^3 . Equations (1)–(4) apply to both the big bang explanation and the stretching explanation.

But where did that energy come from? Here is where the big bang and stretching explanations clash. According to the big bang, the energy came from inflation, but inflation is simply a made-up term to account for the expansion.² Inflation is not scientifically demonstratable. As famed cosmologist, Steinhardt, admitted:

*The inflationary paradigm is fundamentally untestable, and hence scientifically meaningless.*⁶⁶

Furthermore, having energy increase *within* the universe violates the law of conservation of energy, but having energy come *from outside* the universe does not. This also falsifies the big bang explanation.

Nor is the stretching explanation scientifically demonstratable. However, thousands of years before Hubble's law was discovered, five different books of the Bible asserted that God "stretched out the universe." Just because neither process is repeatable or was observed by humans, doesn't mean that one of them isn't correct. The test must be, "*Which explanation does today's observable evidence support?*" As you have seen, 33 separate evidences, listed in Table 27 on page 448, contradict the big bang explanation, but support the stretching explanation.

bang theory).⁶³ Had the universe been slightly less dense by one part in 10^{62} , “the universe would have expanded “so quickly and become so sparse it would soon seem essentially empty, and gravity would not be strong enough by comparison to cause matter to collapse and form galaxies.”⁶⁴ The stretching explanation does not have this problem.

Cut-Off Problem. Nor does stretching have the big bang’s “cut-off problem. If you stretch something, you do not need to stop the stretching at a precise instant to achieve the spread you want. However, because for 10^{-32} seconds inflation was accelerating, it had to stop within a tiny fraction of those 10^{-32} seconds. Had inflation stopped too soon, the universe would have eventually collapsed back on itself. Had inflation overshot its cut-off time, every particle in the universe, including every subatomic particle in your body, would have continued on a hyperbolic orbit. Atoms would never have come together. You wouldn’t exist!

Dark “Science.” The big bang theory must invoke unscientific concepts, such as “dark matter” and “dark energy,” to try to explain the “stretched out heavens.” What is dark matter? What is dark energy? Even believers in those ideas don’t know, and some admit that those phrases are “expressions of ignorance [by those who accept the big bang theory].”

*No one knows what dark matter is, but they know what it is not. It’s not part of the “standard model” of physics that weaves together everything that is known about ordinary matter and its interactions.*⁶⁰

*We know little about that sea [of dark matter and dark energy]. The terms we use to describe its components, “dark matter” and “dark energy,” serve mainly as expressions of our ignorance.*⁵⁹

Dark matter, dark energy, and many other scientific problems with the big bang theory are discussed beginning on page 32.

Accelerating Expansion. The redshift of distant starlight shows an expansion. Just as a ball thrown upward must slow (decelerate) as it moves away from the Earth, a big bang would have produced only a decelerating expansion, after the 10^{-32} second inflationary burst ended and the universe was the size of a basketball. But, in 1998 it was discovered that distant galaxies were accelerating away from us. Saying, without any experimental evidence or physical details, that “dark energy” produced this acceleration is simply a reflection of ignorance. [See “Dark Thoughts” on page 33.]

Stretching, completed during the creation week (not in 10^{-32} of a second after time began), ended with a universe nearly the size of our present universe—not a universe the size of a basketball. We should not be surprised that we can detect distant accelerations produced during that stretching.

Cosmic Microwave Background (CMB). The CMB is often given as evidence for the big bang theory. Actually, the absence of gravitational waves in the CMB, argues against the big bang and is evidence for the sudden creation of

matter within a much smaller universe that was stretched out on Day 4. [For details, Figure 227 and pages 460–461.]

Comparison of Evidence vs. Theories

Table 27 compares the big bang and stretching explanations in 33 different ways. Neither explanation is scientific in the sense that it can be repeated or observed. However, the scientific evidence overwhelmingly favors the stretching theory. Many additional problems with the big bang theory are explained at “Big Bang?” on page 32.

Table 27. Origin of the Universe

	Page	Theories	
		Stretching	Big Bang
Produces Hubble’s Law	439	YES	NO
Temperatures Never Infinite	439	●	⊗
Slowly Spinning Sun	440	●	⊗
Star Formation	440	●	⊗
Binary Stars	440	●	⊗
Planet Formation	440	●	⊗
Hot Jupiters	441	●	⊗
Intergalactic Medium	441	●	⊗
Two Very Close Black Holes	441	●	⊗
Quasars and Light	442	●	⊗
The Eddington Limit	442	●	⊗
Galaxies and Stars	442	●	⊗
Angular Momentum	442	●	⊗
Colliding Galaxies	443	●	⊗
Galaxies and Black Holes	443	●	⊗
Central Stars	444	●	⊗
Strings of Galaxies	444	●	⊗
Dwarf Galaxies	445	●	⊗
Distant Galaxies	445	●	⊗
Starburst Galaxies	445	●	⊗
Matter and Antimatter	446	●	⊗
Helium-2 Nebulas	446	●	⊗
Stellar Velocities	446	●	⊗
Speeding Galaxies	446	●	⊗
Spinning Galaxies	446	●	⊗
The Flatness Problem	446	●	⊗
The Cut-off Problem	448	●	⊗
Dark Science	448	●	⊗
MBH in Center of Galaxies	446	●	⊗
Accelerating Expansion	448	●	⊗
Cosmic Microwave Background	448	●	⊗
Friedmann’s Equation	447	●	⊗
Spiral Galaxies	455	●	⊗

Key: ● Explained by theory.
 ● Theory has moderate problem with this item.
 ⊗ Theory has serious problems with this item.

Summary

Robert Jastrow (1925–2008), a leading figure in NASA’s Apollo program to land men on the moon and the founding director of Goddard Institute for Space Studies, aptly summarized this topic.

*Now we see how the astronomical evidence supports the biblical view of the origin of the world. The details differ, but the essential elements in the astronomical and biblical accounts of Genesis are the same: the chain of events leading to man commenced suddenly and sharply at a definite moment in time, in a flash of light and energy.*⁶⁷

Jastrow, an agnostic and big bang believer, did not have the advantage we now have of seeing all 32 recent evidences (summarized in Table 27) that contrast the big bang vs. the stretching explanations. Nor is there any reason to believe that Jastrow ever considered the stretching explanation. He recognized that no known physical forces could produce a big bang and its inflation.

*Astronomers now find they have painted themselves into a corner because they have proven, by their own methods, that the world began abruptly in an act of creation to which you can trace the seeds of every star, every planet, every living thing in this cosmos and on Earth. And they have found that all this happened as a product of forces they cannot hope to discover. That there are what I or anyone would call supernatural forces at work is now, I think a scientifically proven fact.*⁶⁸

Robert Jastrow’s most quoted statement by far is still true today, except for three modifications I inserted in brackets:

1. What does it mean to stretch out the heavens like a tent or tent curtain? First, imagine what it would be like transporting a large, heavy tent or tent curtain on a long trip, setting it up each afternoon and tearing it down the next morning—an experience familiar to Abraham’s descendants. In preparation for each day’s travel, you would fold the tent in even, accordion-like folds, so at your destination a few strong men could grab the top-most fold and, with one long, continuous, running pull, completely stretch the tent out on the ground. The momentum of the men and the moving portions of the tent would help pull out subsequent tent folds.

Notice, the folded tent occupies a small but finite volume, and it is then stretched from without, *not pushed from within*. The folded tent would look like the springs in Figure 226 on page 443. Each fold of the tent would be of equal width and would lie horizontally on top the fold below.

What would the stretching speed would be for each fold as the tent or curtain was stretched out. The top-most fold would move the farthest and fastest. The bottom-most fold would be

*For the [atheistic] scientist who has lived by his faith in the power of reason, the story ends like a bad dream. He [believes he] has scaled the mountains of ignorance; he is about to conquer the highest peak; as he pulls himself over the final rock, he is greeted by a band of theologians who have been sitting there for centuries [actually, a few thousand years].*⁶⁹

With both the big bang and stretching explanations, it is difficult to imagine time beginning, the sudden presence of matter and energy in a small universe, then a brief but enormous expansion of space when all the laws of physics did not operate. The big bang theory says that space and light expanded for less than 10^{-32} of a second (a billionth, billionth, billionth of a hundred thousandth of a second) from a mathematical point—*trillions of billions of times faster than the speed of light today*. The stretching explanation says that days after the creation of time and all matter, a smaller universe than we have today was rapidly stretched out, along with light waves in that space. Although no *scientific* explanation can be given for either form of expansion, the stretching interpretation best fits the observable evidence.

We also can appreciate why at least eleven Bible passages, involving five different writers, mention the “stretched out heavens.” Another verse, Psalm 19:1, takes on a new depth of meaning: “*The heavens are telling of the glory of God, and their expanse is declaring the work of His hands.*” Can any human mind take it all in?

Table 28. Erroneous Theories Forced into the Bible by Some

Erroneous Secular Theory	Salesman	Organizations or Books
The big bang theory explains Creation	Hugh Ross	Reasons to Believe
Plate tectonic theory explains the flood	John Baumgardner	Institute for Creation Research, Answers in Genesis
Canopy theory explains the flood	Henry Morris, John Whitcomb	<i>The Genesis Flood</i>

References and Notes

stretched the least. Each fold would be stretched out sequentially. Likewise, as we look out—and back in time—at the stretched out heavens, we see stars and galaxies receding at a velocity proportional to their distance from us. **This is succinctly expressed as Hubble’s law.** As explained on page 447, Hubble’s law is a consequence of God stretching out the universe.

The stretching explanation visualizes the expansion of the universe as the stretching out of a tent or curtain. As space expands, matter and light waves are carried along. A frequent analogy of this is that of raisin-bread being baked. The dough (representing space) expands, and the imbedded raisins (representing matter and light waves) are carried outward by the dough, but do not move relative to the dough.

2. Neither the stretching nor inflation events were observed by man; neither can be reproduced. In that sense, neither is scientific. However, as you will see, the scientific evidence overwhelmingly supports the creation/stretching explanation.

The inflationary big bang was proposed by Alan H. Guth in a paper titled “A Possible Solution to the Horizon and

Flatness Problem” in *Physical Review, D*, Vol. 23, 15 January 1981, pp. 348–356. Inflation allegedly reached speeds trillions of billions of times faster than the speed of light. Supposedly, after 10^{-32} of a second, inflation arbitrarily stopped. As explained in **“Dark Thoughts”** on page 33, dark matter and dark energy are simply non-scientific fudge factors that should be ignored.

If inflation happened, it had to shut off at *precisely* the right time and speed. If, when inflation stopped, the expansion had been going too fast (by only one part in 10^{59}) matter would never have come together to form stars and galaxies. If, when inflation stopped, it had been going too slowly by only one part in 10^{59} , all matter would have collapsed into one big black hole after 13.7-billion years, and we would not be here to think about it. Keep in mind, that all this inflation happened by an unknown, untestable phenomenon—not by a blast.

3. Andrei Linde, “The Self-Reproducing Inflationary Universe,” *Scientific American*, Vol. 271, November 1994, p. 48.
4. Both the big bang theory and the stretching explanation agree that in the beginning, energy and matter appeared out of nothing, and then the universe suddenly expanded greatly. Those profound ideas were written by five different authors (in Job, Isaiah, Jeremiah, Zechariah, and the Psalms) thousands of years before the big bang theory was proposed. Since then, man’s scientific ideas about the universe have changed many times—and are recognized, in hind sight, as quite fallible. Forcing a secular theory into the Bible will eventually discredit that biblical interpretation—and unfortunately—the Bible.

Some have taken a secular theory and tried to sell it to Christian audiences by claiming that the Bible supports it. Later, when that scientific idea is disproved, many blame the Bible rather than the secular theory or its salesman. Readers of this book have already seen examples of this unfortunate practice. (Check [Table 28](#) and then the index for details.)

5. “Using the Hubble Space telescope, astronomers have detected light from the most distant object yet found—a fledgling galaxy that existed when the Universe was just over 420 million years old.” Phillip Campbell, “A Galaxy Far, Far Away,” *Nature*, Vol. 493, 10 January 2013, p. 137.
6. For examples, see **“Molten Earth?”** on page 28.
7. “According to inflationary cosmology, the universe [began] growing from a patch as small as 10^{-26} m, one hundred billion times smaller than a proton, ...” Alan H. Guth and David I. Kaiser, “Inflationary Cosmology: Exploring the Universe from the Smallest to the Largest Scales,” *Science*, Vol. 307, 11 February 2005, p. 885.
8. Robert Jastrow, *Red Giants and White Dwarfs* (New York: Harper & Row, Publishers, 1967), p. 63.
9. Kaitlin M. Kratter, “Sibling Rivalry Begins at Birth,” *Nature*, Vol. 518, 12 February 2015, p. 173.
10. “... the quadruple stellar system itself is bound but unstable on timescales of 500,000 years... [and therefore, young—less than 500,000 years old].” Jaime E. Pineda et al., “The Formation of

a Quadruple Star System with Wide Separation,” *Nature*, Vol. 518, 12 February 2015, pp. 213–215.

11. Dan Falk, “Planet Formation,” *Nature*, Vol. 422, 17 April 2003, p. ix.
12. “... we now know that planets can form in binaries, ...” Kratter, p. 173.
13. William E. Welsh and Laurance R. Doyle, “Worlds with Two Suns,” *Scientific American*, Vol. 309, November 2013, p. 42.
14. Leslie Sage, “Nature Insight: Exoplanets,” *Nature*, Vol. 513, 18 September 2014, p. 327.
15. “These ‘hot Jupiters’ could not have formed in situ, given the large stellar tidal gravity and radiation fields close to their host stars. Instead they are thought to have formed beyond a few astronomical units (AU) and migrated inward. However, the physical mechanisms of the migration remain unclear.” Natalia I. Storch et al., “Chaotic Dynamics of Stellar Spin in Binaries and the Production of Misaligned Hot Jupiters,” *Science*, Vol. 345, 12 September 2014, p. 1317.
16. “Indeed, isolated ‘hot Jupiters’ are often misaligned and even orbiting retrograde.” Roberto Sanchis-Ojeda et al., “Alignment of the Stellar Spin with the Orbits of a Three-Planet System,” *Nature*, Vol. 487, 26 July 2012, p. 449.
17. “Many of these ‘hot Jupiters’ are strongly misaligned with the equators of their stars. The fact that some planetary orbits can be neatly aligned with the plane of their star’s equator, whereas others are wildly misaligned, shows that we have much still to learn about the formation and orbital evolution of planets.” Drake Deming, “Planets on the Spot,” *Nature*, Vol. 487, 26 July 2012, p. 434.
 - ◆ “The discovery of spin-orbit misalignment in close-in exoplanetary systems in the past few years was a major surprise in planetary astrophysics.” *Ibid.*, p. 1321.
18. “...reionization is poorly understood.” Eilat Glikman, “A Beacon at the Dawn of the Universe,” *Nature*, Vol. 553, 25 January 2018, p. 411.
19. “[Astronomer Richard S.] Ellis notes that the new findings also hint at a puzzle. His team estimates that the distant galaxies, which are too tiny to be clearly resolved by Hubble, are making stars at a puny rate. In some cases, that rate is as low as the mass equivalent of 0.0025 suns per year. According to current models, that rate couldn’t have generated enough ultraviolet starlight for a critical milestone in the evolution of the universe—the wrenching apart of neutral hydrogen into their subatomic constituents.” Ron Cowen, “Hubble’s New Finds Go the Distance,” *Science News*, Vol. 176, 10 October 2009, p. 8.
20. “These supermassive black holes pose major puzzles: Why are they so common in galaxies? Which came first—the galaxy or the hole? And how did they form in the first place?” Jenny E. Greene, “Goldilocks Black Holes,” *Scientific American*, Vol. 306, January 2012, p. 42.
21. “Theorists predict that stellar-mass black holes are abundant. If this is so, we should find them all over the Milky Way. ... There are probably tens of millions of massive stars in the Milky Way that could potentially collapse into black holes, but there are only about 50 stellar-mass black holes known with good confidence.”

- M. Virginia McSwain, "Black Hole Found Orbiting a Fast Rotator," *Nature*, Vol. 505, 16 January 2014, p. 297.
22. "The galaxy, named EGSY8p7, is more than 13.2 billion light-years (4 billion parsecs) away." Philip Campbell, "The Farthest Galaxy So Far," *Nature*, Vol. 525, 17 September 2015, p. 293.
 23. "Astronomers struggle to explain how some supermassive black holes could have formed in about 1 billion years out of only smaller black holes merging. 'There's just not enough time to do that,' Smith says." Christopher Crockett, "Black Hole Born Without Stellar Parent," *Science News*, Vol. 190, 6 August 2016, p. 7.
 - ◆ "The masses of these early black holes are inferred from their [quasar] luminosities to be $>10^9$ solar masses, which is a difficult theoretical challenge [for the big bang theory] to explain." Rennan Barkana and Abraham Loeb, "Spectral Signature of Cosmological Infall of Gas Around the First Quasars," *Nature*, Vol. 421, 23 January 2003, p. 341.
 - ◆ "The daunting problem for theories of structure formation in the Universe is to understand how such huge black holes [3 billion solar masses] and the vast reservoirs of gaseous fuel were assembled so soon after the Big Bang ..." Edwin L. Turner, "Through a Lens Brightly," *Nature*, 27 June 2002, p. 905.
 - ◆ "Astronomers are puzzled about how the oldest supermassive black holes could have grown so big so early in cosmic history." Priyamvada Natarajan, "The First Monster black Holes," *Scientific American*, Vol. 318, February 2018, p. 24.
 24. Robert Antonucci, "Quasars Still Defy Explanation," *Nature*, Vol. 495, 14 March 2013, p. 165.
 25. See Endnote 6 on page 463.
 26. Chris Willott, "A Monster in the Early Universe," *Nature*, Vol. 474, 30 June 2011, p. 583.
 27. "Some supermassive black holes spin at more than 90% of the speed of light, which suggests that they gained their mass through major galactic mergers." Eugenie Samuel Reich, "Spin Rate of Black Holes Pinned Down," *Nature*, Vol. 500, 8 August 2013, p. 135.
 - ◆ Christopher S. Reynolds, "Black Holes in a Spin," *Nature*, Vol. 494, 28 February 2013, p. 433.
 28. One might claim that the algebraic sum of the angular momenta of all matter in the universe might be zero. A study examined 15,158 galaxies with redshifts <0.085 from the Sloan Digital Sky Survey. The net angular momentum of all those galaxies was so far from zero that the probability that the sample of 15,158 galaxies was drawn from an infinite population with a net angular momentum of zero was about one in a million. [See Michael J. Longo, "Detection of a Dipole in the Handedness of Spiral Galaxies with Redshifts $Z \approx 0.04$, *Physics Letters B*, Vol. 699, 16 May 2011, pp. 224–229.]
 29. Adrian Cho, "Triumph for Gravitational Wave Hunt," *Nature*, Vol. 351, 12 February 2016, pp. 645–646.
 30. "To merge within the age of the Universe, the black holes responsible for GW170104 must have once been separated by a distance no greater than one-fifth that of Earth from the Sun." Ilya Mandel and Alison Farmer, "Stellar Palaeontology," *Nature*, Vol. 547, 20 July 2017, p. 284.
 31. Evolutionists cannot imagine how those two black holes could have formed and been so close together, so soon after a big bang. Clearly, they could not have formed from:
 - i. the collapse of two spinning gas and dust clouds. Clouds that close together would have interfered with each other, merged, and produced one black hole, not two.
 - ii. two massive stars that ran out of fuel, collapsed, became supernova and left two black holes. The first to become a supernova would have destroyed and scattered the second. Besides, the centers of two massive stars would be farther apart than 0.2 AU.
 - iii. two massive stars so far apart that they didn't interfere with each other before they each produced a black hole. Then, chance interactions with other black holes brought them into orbit around each other. However, that would be highly improbable, would have required more time, so those black holes would have had to have begun orbiting each at and even closer separation than 0.2 AU.

As normally happens when evolutionists are faced with problems their theory produces is to state the need for more research.

Researchers now hope to find out how such pairings came to be. [See Davide Castelvecchi, "Here Come the Waves," *Nature*, Vol. 556, 12 April 2018, p. 165]

Obviously, there was no (i) big bang-to-spinning cloud stage, and no (ii) big-bang-to star stage. The matter began in a very compact universe, that was later stretched out. Yes, expansion happened, but not by a made-up phenomena (inflation) in a hot big bang.
 32. "But the standard model [the big bang theory] still can't easily account for a large number of mature or massive galaxies in the early universe." Ron Cowen, "Mature Before Their Time," *Science News*, Vol. 163, 1 March 2003, p. 139.
 - ◆ "Extremely massive galaxies are seen in the young universe, but their presence is puzzling because we do not yet understand how they became so massive so quickly. How do they get enough fuel to form stars so rapidly?" Nina Hatch, "Galaxy Formation Through Cosmic Recycling," *Science*, Vol. 354, 2 December 2016, p. 1102.
 - ◆ "But this uniformity [in the cosmic microwave background (CMB) radiation] is difficult to reconcile with the obvious clumping of matter into galaxies, clusters of galaxies, and even larger features extending across vast regions of the universe, such as 'walls' and 'bubbles'." Ivars Peterson, "Seeding the Universe," *Science News*, Vol. 137, 24 March 1990, p. 184.
 - ◆ "Gravity can't, over the age of the universe, amplify these irregularities enough [to form huge clusters of galaxies]." Margaret Geller, as quoted by John Travis, "Cosmic Structures Fill Southern Sky," *Science*, Vol. 263, 25 March 1994, p. 1684.
 - ◆ "Yet how could the universe have gone from homogeneous plasma to pancakes to galaxies so quickly? Gravity alone was simply not strong enough to do it." M. Mitchell Waldrop, "The Large-Scale Structure of the Universe," *Science*, Vol. 219, 4 March 1983, p. 1051.
 - ◆ Robert Irion, "Early Galaxies Baffle Observers, but Theorists Shrug," *Science*, Vol. 303, 23 January 2004, p. 460.

33. Michael Lemonick, “The Great Cosmic Census,” *Discover*, March 2009, p. 64.
34. “*More embarrassing to astrophysicists is our lack of understanding of black hole jets—phenomena in which the forces near a supermassive black hole somehow conspire to spew out material at ultrarelativistic speeds (up to 99.98 percent of light speed). These amazing outflows traverse distances larger than galaxies, ...*” Avery E. Broderick and Abraham Loeb, “Portrait of a Black Hole,” *Scientific American*, Vol. 301, December 2009, p. 44.
35. “*... merging two spiral galaxies to make an elliptical [galaxy] is statistically improbable [in today’s vast universe].*” James E. Gunn, as quoted by Karen Hartley, “Mixing It Up in Space,” *Science News*, Vol. 135, 8 April 1989, p. 219.
36. Dozens of colliding galaxies can be seen in Hubble Ultra Deep Field photograph. See James, Renée, “Hubble Deep Field,” *Discover*, Vol. 37, July–August 2016, p. 81.
37. R. P. Deane et al., “A Close-Pair Binary in a Distant Triple Supermassive Black Hole System,” *Nature*, Vol. 511, 3 July 2014, pp. 57–60.
38. “*Other studies of elliptical galaxies have found additional signs of recent merging. In some ellipticals, for example, the central region rotates in one direction, while the outer parts spin the other way. Such a countervailing rotation pattern would be difficult to explain if these galaxies formed all of one piece but could come about quite naturally from a merger.*” [emphasis added] Barnes et al., p. 41.
39. Charles Petit, “Ultra Massive: As Big As It Gets,” *Science News*, Vol. 174, 25 October 2008, p. 20.
40. “*These black holes at the centers of galaxies are big (as black holes go). But compared with a galaxy, they’re really small. So they don’t have that much of an effect; we have nothing to fear. They only affect the very closest stars to them. But recently it was observed that the mass of a central black hole correlates with the mass of the galaxy around it! Before that observation, we didn’t know if the black hole formed first and then the galaxy formed around it, or if the galaxy formed first and then the black hole formed from the galaxy. **The correlation means that the black hole and galaxy had to form together.** They couldn’t be separate events because a black hole can’t affect an object as big as a galaxy.* [emphasis added] Andrea Ghez, “Frontiers of Astronomy,” *Discover*, May 2009, p. 44.
41. Rychard Bouwens, “Quasars Signpost Massive Galaxies,” *Nature*, Vol. 545, 25 May 2017, p. 418.
- ◆ Decarli, R et. al., “Rapidly Star-Forming Galaxies Adjacent to Quasars at Redshifts Exceeding 6,” *Nature*, Vol. 545, 25 May 2017, p. 457–461.
42. “*How and why the bulge formed is still something of a mystery.*” Alexandra Witze, “At Home in the Universe,” *Science News*, Vol. 181, 15 June 2012, p. 24.
43. “[A massive black hole, 21,000,000 times more massive than the Sun, lies at the center of a small galaxy.] *It cries out for an understanding that we don’t have.*” John Kormendy as quoted by Christopher Crockett, “Tiny Galaxy Is Home to Huge Black Hole,” *Science News*, Vol. 186, 1 November 2014, p. 9.
- ◆ Anil C. Seth et al. “A Supermassive Black Hole in an Ultra-Compact Dwarf Galaxy,” *Nature*, Vol. 513, 18 September 2014, pp. 398–400.
44. Remco C. E. van den Bosch et al., “An Over-Massive Black Hole in the Compact Lenticular Galaxy NGC 1277,” *Nature*, Vol. 491, 29 November 2012, pp. 729–731.
45. “*Violent encounters between galaxies appear surprisingly common.*” Joshua Barnes et al., “Colliding Galaxies,” *Scientific American*, Vol. 265, August 1991, p. 40.
46. “*The black hole’s inactivity [today] suggests that the central few light years doesn’t contain enough raw material to make stars. And the enormous gravitational tidal forces around the black hole would seem to prohibit stars from forming even if the material were there: it’s hard for a cloud of gas to contract into a star under its own gravity when something that weighs as much as four million stars is sitting next door.*” Jeff Kanipe, “A Long Time Ago, in a Galaxy Not So Far Away,” *Nature*, Vol. 446, 5 April 2007, p. 601.
- ◆ “*... the stars we studied to prove that there was a black hole turned out to be very young. Young stars have absolutely no right to be next to a black hole because [the tidal forces of] a black hole should shear them apart [if they evolved]. We have no idea how these stars formed.*” Ghez, p. 43.
47. Kanipe, p. 602.
48. “*Astrophysicists can model the accreting material to some extent, but it is unclear how gas in the accretion flow migrates from an orbit at a large radius to one near the [event] horizon ...*” Avery E. Broderick and Abraham Loeb, p. 44.
49. Adrian Cho, “The Galaxy Builders,” *Science*, Vol. 360, p. 955.
50. “*Thirty-seven of the brightest galaxies were detected, including a quasar, but thousands of galaxies were probably in the string, according to astronomer Dr. Paul Francis who heads the team. But none of the existing computer simulation models were able to reproduce galaxy strings as large as the one the team found. ‘We are looking back four-fifths of the way to the beginning of the universe and the existence of this galaxy string will send astrophysicists around the world back to the drawing board to re-examine [big bang] theories of the formation of the universe,’ Francis said. The simulations tell us that you cannot take the matter in the early universe and line it up in strings this large. There simply hasn’t been enough time since the Big Bang for it to form structures this colossal.*” *Science & Space*, “Galaxy Find Stirrs Big Bang Debate” on 8 January 2004 at: www.cnn.com/2004/TECH/space/01/08/galaxies.find.
- ◆ Paul J. Francis et al., “An 80 Mpc Filament of Galaxies at Redshift $Z=2.38$,” *Proceedings, The American Astronomical Society* (Atlanta, Georgia), 7 January 2004.
 - [80 Mpc = 1,500,000,000,000,000,000 miles
 - = 2,400,000,000,000,000,000 kilometers
 - = 261,000,000 light-years]
- ◆ M. Mitchell Waldrop, “The Large-Scale Structure of the Universe Gets Larger—Maybe,” *Science*, Vol. 38, 13 November 1987, p. 894.
- ◆ M. Mitchell Waldrop, “Astronomers Go Up Against the Great Wall,” *Science*, Vol. 246, 17 November 1989, p. 885.

51. *"If anything, the Planck data disfavored the simplest inflation [big bang] models and exacerbated long-standing foundational problems with the theory, providing new reasons to consider competing ideas about the origin and evolution of the universe. ...For the first time in more than 30 years, the simplest inflationary models, including those described in standard textbooks, are strongly disfavored by observations."* Anna Ijjas et al., "Pop Goes the Universe: The latest Astrophysical Measurements, combined with Theoretical Problems, Cast Doubt on the Long-Cherished [big bang] Inflationary Theory of the Early Cosmos and Suggest We Need New Ideas." *Scientific American*, Vol. 316, February 2017, pp. 34, 36.
- Is the "Big Stretch," described here, that new idea?**
52. *"... primordial black holes could also explain the uneven distribution of infrared light in the cosmic background."* Jeff Hecht, "What's the Matter?" *Nature*, Vol. 537, 29 September 2016, p. S194.
53. *"No one knows where they come from."* "Steve Nadis, "As the Mighty Quasars Flow," *Discover*, June 2018, p. 70.
54. Robert Irion, "The Hunt for Stealth Galaxies," *Science*, Vol. 308, 20 May 2005, pp. 1104–1106.
- ◆ *"The existence of quiescent, extended gaseous disks around a handful of dwarf irregular galaxies is puzzling."* Liese van Zee, "A Large Gas Disk Around a Small Galaxy," *National Radio Astronomy Observatory Newsletter*, Issue 103, April 2005, p. 13.
55. *"The discovery of massive, evolved galaxies at much greater distances than expected—and hence at earlier times in the history of the Universe—is a challenge to our understanding of how galaxies form."* Gregory D. Wirth, "Old Before Their Time," *Nature*, Vol. 430, 8 July 2004, p. 149.
- ◆ A. Cimatti et al., "Old Galaxies in the Young Universe," *Nature*, Vol. 430, 8 July 2004, p. 184.
 - ◆ David Shiga, "Nursery Pictures," *Science News*, Vol. 167, 5 March 2005, pp. 148–149.
 - ◆ *"Until now, we wouldn't think that you could make galaxies emerge that early in the universe."* George Helou, as quoted by Alex Hutchinson, "New and Old Galaxies Show Up in All the Wrong Places," *Discover*, January 2006, p. 61.
 - ◆ *"Galaxy-formation theory is in peril."* Ron Cowen, "Crisis in the Cosmos?" *Science News*, Vol. 168, 8 October 2005, pp. 235–236.
56. See **"How Old Do Evolutionists Say the Universe Is?"** on pages 461–463.
57. *"During the past decade, researchers have learned that these high-redshift starbursts reside in exceptionally massive haloes of dark matter (with masses equivalent to 10 trillion Suns)."* Desika Narayanan and Chris Carilli, "A Cosmic Growth Spurt in an Infant Galaxy," *Nature*, Vol. 496, 18 April 2013, p. 303.
58. William R. Corliss, *Stars, Galaxies, Cosmos: A Catalog of Astronomical Anomalies* (Glen Arm, Maryland: The Sourcebook Project, 1987), p. 177.
59. David B. Cline, "The Search for Dark Matter," *Scientific American*, Vol. 288, March 2003, p. 52.
60. Jenny Hogan, "Welcome to the Dark Side," *Nature*, Vol. 448, 19 July 2007, p. 241.
- ◆ *"In addition to the lack of antimatter, every list of the biggest mysteries in physics includes the natures of three things: dark energy, dark matter, and cosmic inflation. These three all posited as ad hoc solutions to problems posed by cosmological observations that do not fit predictions arising from the general theory of relativity. Dark energy is needed to explain why the cosmic expansion is not slowing down; dark matter is invoked to resolve why galaxies are rotating too fast to be bound by gravity due to visible matter; and cosmic inflation is needed to explain [the horizon problem—See Figure 226 on page 443.] how all parts of the Universe are the same temperature when the Big Bang occurred too quickly for everything to be causally connected (that is, regions of the visible Universe separated before light, and therefore temperature information, from one region could reach all other regions.)"* Thomas J. Phillips, "Antimatter May Matter," *Nature*, Vol. 529, 21 January 2016, pp. 294–295.
61. *"We do not understand how the Universe works at a deeper and more profound level than most of us care to admit."* Astrophysicist, Stacy McGaugh, as quoted by Elizabeth Gibney, "Dark-Matter Hunt Comes Up Empty," *Nature*, Vol. 551, 9 November 2017, p. 153.
62. *"Hotter stars are not predicted by normal stellar evolution, so the presence of the He II nebulae is a bit of a mystery."* Donald R. Garnett, as quoted by Ron Cowen, "Gorgeous Gas," *Science News*, Vol. 163, 24 May 2003, p. 328.
63. Big bang advocates make the following two key assumptions, which few realize—including most authors and professors:
- a. all matter—and space—came from a point one quadrillionth the size of an atom, and
 - b. The universe's current expansion rate can be extrapolated back to a mathematical point.
- If both were true, the age of the universe would be $1/H$ where H is the Hubble constant—the current expansion rate. $H = 71.2$ kilometers/sec per megaparsec. (A megaparsec = 3.26×10^6 light-years.) If these key assumptions were true, the age of the universe would be 13.7-billion years.
- But both the big bang and stretching advocates agree that *today's expansion rate has not always been the same*: (1) the expansion rate is accelerating, and (2) when time began, there was a brief period of unbelievably rapid expansion. **There has been no scientific explanation for either.**
- Unfortunately, scientists unaware, or unwilling to acknowledge, that science can't explain the expansion, and lay people, impressed with that mind-boggling age when they hear it from the media or some authority, never ask the question, "How was that age determined and what assumptions were made?"
64. *"The early universe must have had a density even closer to the critical density [ρ_c], departing from it by one part in 10^{62} or less."* https://en.wikipedia.org/wiki/Flatness_problem, last accessed: 13 December 2016.
- By having the density be the critical density, the sum of the kinetic and potential energies would be exactly zero. The wikipedia reference above explains how the energy density of the universe was almost exactly equal to the critical density

during the entire expansion and departed from it by less than one part in 10^{62} . Amazing—and “very good”! (Genesis 1:31)

The “flatness problem” is also called the “Oldness” Problem.” Billion-year ages for the universe, Earth, and life generate a fatal problem for the big bang and evolution that few realize.

- ◆ Those unfamiliar with orbital mechanics frequently ask a good question: “How can the sum of two energies (kinetic plus potential) be zero?” Kinetic energy is always positive, because it is proportional to the square of a velocity. (Squaring any real number, positive or negative, always produces a positive number.)

However, *potential energy* is measured relative to some arbitrary horizontal plane. For example, the potential energy of a pound weight you hold a foot above the floor would be 1 foot-pound, if you have chosen that floor as your reference plane. But if your reference plane is the basement floor, 10 feet below the weight, its potential energy would be 10 foot-pounds. We can pick the reference plane that best simplifies all our calculations. For orbital calculations, that turns out to be a reference plane at infinity. Potential energies at lower elevations than infinity (which, of course, is everything) are always negative numbers. When a mass is lifted, it gains potential energy. Mathematically, its potential energy becomes *less* negative. Therefore, the sum of

potential energy (always a negative number) and kinetic energy (always a positive number) could be zero.

Each particle in an expanding universe has an energy equal to its kinetic plus potential energy. The algebraic sum of the energies of every particle in the universe must be close to zero if two important requirements are satisfied: (a) it is not expanding so fast that it will fly apart, and (b) it is expanding fast enough to prevent the universe from eventually collapsing on itself in a “big crunch.” As each particle approaches infinity, its potential energy approaches zero and its velocity steadily decreases and approaches zero.

65. This raises what may be one of the most natural questions of all time. “If the universe is finite and has a boundary, what lies just beyond that boundary?” Possibly nothing, just as no time or space existed before the creation.
66. Paul Steinhardt, “Big Bang Blunder Bursts the Multiverse Bubble,” *Nature*, Vol. 510, 5 June 2014, p. 9.
67. Robert Jastrow, *God and the Astronomers* (New York: Warner Books, Inc., 1978), pp. 3–4.
68. Robert Jastrow, as quoted by B. Durbin, “A Scientist Caught Between Two Faiths: Interview with Robert Jastrow,” *Christianity Today*, Vol. 26, 6 August 1982, p. 15.
69. Jastrow, *God and the Astronomers*, pp. 105–106

Galaxies Are Billions of Light-Years Away, So Isn't the Universe Billions of Years Old?

The logic behind this common question has several hidden assumptions, two of which are addressed by the following italicized questions:

- a. *Was space, along with light emitted by stars, rapidly stretched out soon after creation began?* If so, energy would have been added to the universe and starlight during that stretching. Pages 439–453 show that the scientific evidence clearly favors this stretching explanation over the big bang theory, which also claims that space expanded rapidly. Yet, the big bang theory says all this expansion energy, plus all the matter in the universe, was, at the beginning of time, inside a volume much smaller than a quadrillionth of an atom.
- b. *Has starlight always traveled at its present speed—about 186,000 miles per second or, more precisely, 300,000 kilometers per second?*

If either (a) space and its starlight were stretched out, or (b) the speed of light was much faster in the past, then distant stars should be visible in a young universe. Pages 439–453 address possibility (a). Here, we will address possibility (b) by examining the historical measurements of the speed of light.

Historical Measurements. During the past 300 years, at least 164 separate measurements of the speed of light have been published. Sixteen different measurement techniques

were used. Astronomer Barry Setterfield has studied these measurements, especially their precision and experimental errors.¹ His results show that ***the speed of light has apparently decreased so rapidly that experimental error cannot explain it!*** Montgomery and Dolphin have critically reexamined all of Setterfield's data, applied various statistical tests, and reached similar conclusions.² In the seven instances where the same scientists remeasured the speed of light with the same equipment years later, a decrease was always reported. The decreases were often several times greater than the reported experimental errors. I have conducted other analyses that give weight (give significance) to each measurement according to its accuracy. Even after considering the wide range of accuracies, it is hard to see how one can claim, with any statistical rigor, that the speed of light has remained constant.³

M. E. J. Gheury de Bray, in 1927, was probably the first to propose a decreasing speed of light.⁴ He based his conclusion on measurements spanning 75 years. Later, he became more convinced and twice published his results in *Nature*,⁵ possibly the most prestigious scientific journal in the world. He emphasized, “If the velocity of light is constant, how is it that, ***invariably***, new determinations give values which are lower than the last one obtained ... There

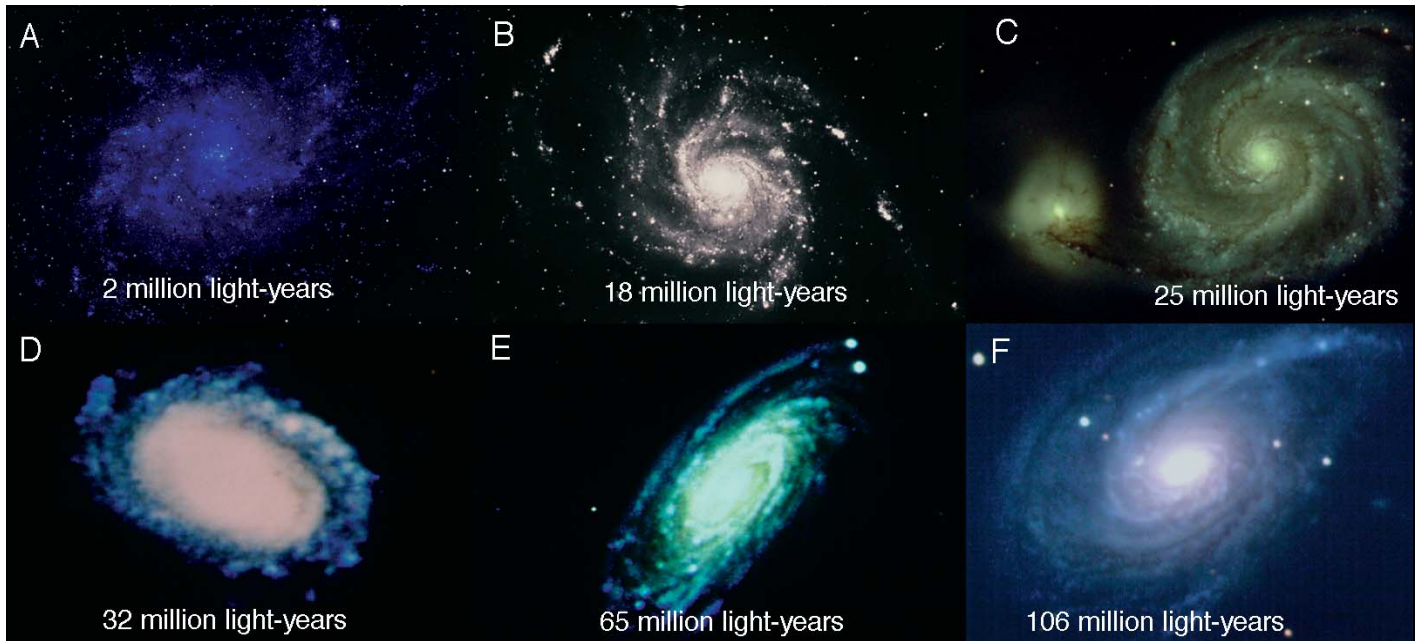

Figure 230: Spiral Galaxies. The arms in these six representative spiral galaxies have about the same amount of twist. Their distances from Earth are shown in light-years. (One light-year, the distance light travels in one year, equals about 5,879,000,000,000 miles.) For the light from all galaxies to arrive at Earth tonight, the more distant galaxies had to release their light long before the closer galaxies. Therefore, the more distant galaxies did not have as much time to rotate and twist their arms, so the farther galaxies should have less twist. But, if light traveled millions of times faster in the past—or if space and its light were stretched out during the creation week, as proposed on pages 439–453—the farthest galaxies did not have to send their light long before the nearest galaxies. Spiral galaxies should have similar twists. This turns out to be the case.⁶

The galaxies are: A) M33 or NGC 598; B) M101 or NGC 5457; C) M51 or NGC 5194; D) NGC 4559; E) M88 or NGC 4501; and F) NGC 772. All distances are taken from R. Brent Tully, *Nearby Galaxies Catalog* (New York: Cambridge University Press, 1988).

are twenty-two coincidences in favour of a decrease of the velocity of light, while there is not a single one against it.”⁷ [emphasis in original]

Although the measured speed of light has decreased only about 1% during the past three centuries, the decrease is statistically significant, because measurement techniques can detect changes thousands of times smaller. While the older measurements have greater errors, the trend of the data is startling. The farther back one looks in time, the more rapidly the speed of light seems to have been decreasing. Various mathematical curves fit these three centuries of data. When some of those curves are projected back in time, the speed of light becomes so fast that light from distant galaxies conceivably could have reached Earth in several thousand years.

Some people have arbitrarily defined the speed of light as a constant. However, no scientific law requires the speed of light to be constant.⁸ Many have simply assumed that it is constant, so changing old ways of thinking is sometimes difficult. Russian cosmologist, V. S. Troitskii, at the Radio-physical Research Institute in Gorky, also questioned some old beliefs. He concluded, independently of Setterfield, that most redshifts of distant starlight are the result of the slowing speed of light, and at the beginning, **the speed of light was 10 billion times faster at time zero!**⁹ Further-

more, he attributed the cosmic microwave background radiation to this rapidly decreasing speed of light. Setterfield reached the same conclusion concerning redshifts by a different method. If either Setterfield or Troitskii is correct, the big bang theory will fall (with a big bang).

Other cosmologists are proposing an enormous decay in the speed of light.¹⁰ Several of their theoretical problems with the big bang theory are solved if light once traveled millions of times faster—or if the universe was initially more compact and was later stretched out as explained on pages 439–453. For example, “the horizon problem” recognizes that opposite extremes of the universe have the same temperature. Why should this be? The universe isn’t old enough for such vastly separated regions ever to have had contact with each other. Light doesn’t travel fast enough—at least not today.

Atomic vs. Orbital Time. Why would the speed of light decrease? In 1981, T. C. Van Flandern, working at the U.S. Naval Observatory, showed that atomic clocks are probably slowing relative to orbital clocks.¹¹ He wrote:

The number of atomic seconds in a dynamical interval (such as a revolution of the Earth about the Sun) is becoming fewer. Presumably, if the result has any generality to it, this means that atomic phenomena are slowing down with respect to

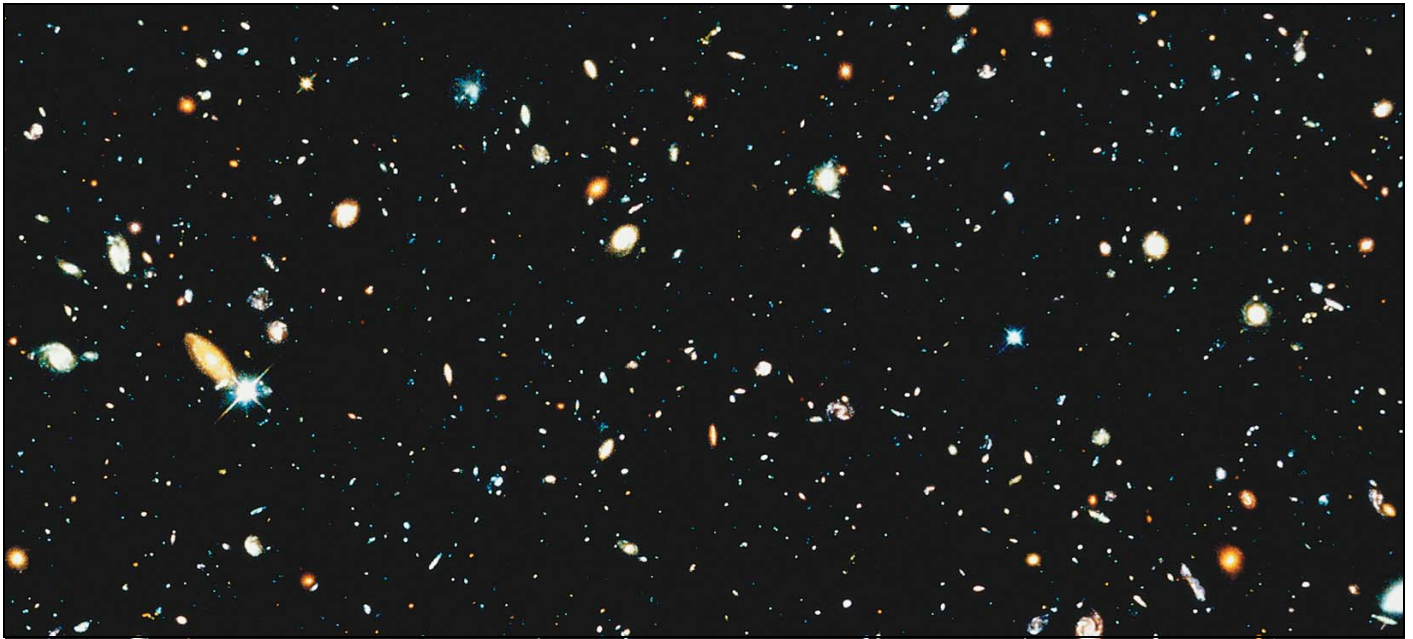

Figure 231: Hubble Deep Field North. There are about 2 trillion galaxies in the visible universe!¹² The Hubble Space Telescope, searching for evolving galaxies in December 1995, focused for 10 continuous days on a tiny patch of sky, so small when viewed from Earth that *a grain of sand held at arm's length would cover that area*. This picture of that tiny patch of sky is called Hubble Deep Field North. Most objects in it are not isolated stars, but *galaxies*, each containing billions of stars. Of the 3,000 galaxies photographed that emitted enough light to measure their redshifts, which presumably measure distance, all seemed surprisingly mature. As stated in *Scientific American*, "... the formation of 'ordinary' spiral and elliptical galaxies is apparently still out of reach of most redshift surveys."¹³ Moreover, fully formed *clusters of galaxies*, not just galaxies, are seen at the greatest distances visible to the Hubble Space Telescope.¹⁴ In 1998 and 2004, similar pictures—with similar results—were taken.

Think about this: There is not enough time in the age of the universe (even as evolutionists imagine it, *times a billion*) for gravity to pull together all the particles comprising clusters of galaxies.¹⁵ (As explained under "**Galaxies**" on page 36, clusters of galaxies cannot form, even granting all this time.) Because the most current studies show fully-formed galaxies even farther away than those shown above,¹⁶ creation becomes the logical and obvious alternative. We may be seeing galaxies as they looked months after they were created. Vast amounts of time are no longer needed. [See page 461.]

*dynamical phenomena. ... we cannot tell from existing data whether the changes are occurring on the atomic level or the dynamical level.*¹⁷

Orbital clocks are based on orbiting astronomical bodies, especially Earth's one-year period about the Sun. Before 1967, one second of time was defined by international agreement as 1/31,556,925.9747 of the average time it takes Earth to orbit the Sun. However, atomic clocks are based on the vibrational period of the cesium-133 atom. In 1967, a second was redefined as 9,192,631,770 oscillations of the cesium-133 atom. Van Flandern showed that if atomic clocks are "correct," the orbital speeds of Mercury, Venus, and Mars are increasing, so the gravitational "constant" should be changing. He also noted that if orbital clocks are "correct," the gravitational constant is truly constant, but atomic vibrations *and* the speed of light are decreasing. The drift between the two types of clocks is only several parts per billion per year. But again, the precision of the measurements is so good that the discrepancy is probably real.

For the following three reasons, orbital clocks seem to be correct and the frequencies of atomic vibrations are probably slowing very slightly.

- ◆ If Van Flandern's studies are correct, the gravitational "constant" should be changing or else atomic vibrations

are slowing slightly. Other studies have not detected variations in the gravitational constant.

- ◆ If a planet's orbital speed increased (and all other orbital parameters remained the same), the planet's energy would increase. That would violate the law of conservation of mass-energy.
- ◆ If atomic frequencies are decreasing, then five "properties" of the atom, such as Planck's constant, should also be changing. Statistical studies of past measurements show that four of the five "constants" are changing—and in the right direction.²

So, orbital clocks seem to be more *accurate* than the extremely *precise* atomic clocks.¹⁸

I initially doubted Setterfield's claim, because the decrease in the speed-of-light measurements ceased in 1960. Large, one-time changes seldom occur in nature. The measurement techniques were precise enough to detect any decrease in the speed of light after 1960, if the trend of the prior three centuries had continued. Later, Setterfield realized that beginning in the 1960s, atomic clocks were used to measure the speed of light. If atomic frequencies are decreasing, then both the measured quantity (the speed of light) and the newly adopted measuring tool (atomic clocks) are changing at the same rate. Naturally, no relative change would be

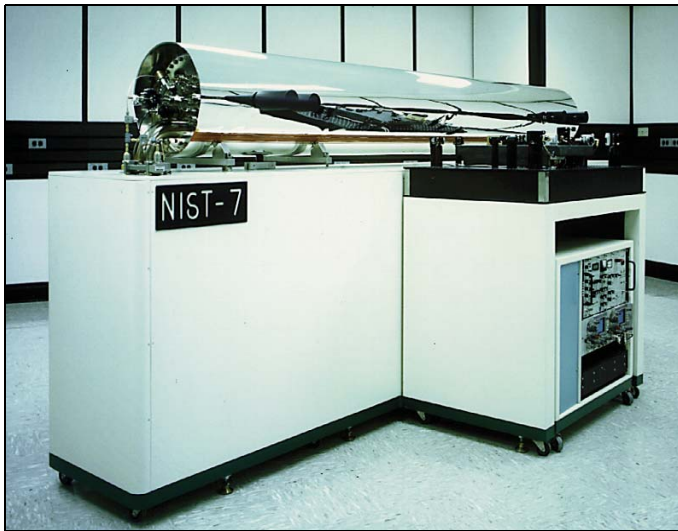

Figure 232: Atomic Clock. This is NIST-7, an atomic clock at the United States National Institute of Standards and Technology. If its time were compared with a similar clock 6-million years from now, they might differ by only one second! The latest development, called NIST-F2, achieves fifty times greater precision by cooling the vibrating atoms to nearly absolute zero. Despite the extreme precision of atomic clocks, we have no assurance that they are not all drifting relative to “true” time. In other words, we can marvel at the *precision* of atomic clocks, but we cannot be certain of their *accuracy*.

detected, and *the speed of light would be constant in atomic time—but not orbital time.*

Misconceptions. Does the decrease in the speed of light conflict with the statement frequently attributed to Albert Einstein that the speed of light is constant? Not really. Einstein said that the speed of light was not altered by the velocity of the light’s source. Setterfield says that the speed of light decreases over time.

Einstein’s statement that *the speed of light is independent of the velocity of the light source*, is called Einstein’s Second Postulate. (Many have misinterpreted it to mean that “Einstein said the speed of light is constant over time.”) Einstein’s Second Postulate is surprising, but probably true. Wouldn’t we expect a ball thrown from a fast train in the forward direction to travel faster than one thrown in the opposite direction, at least to an observer on the ground? While that is true for a thrown ball, some experimental evidence indicates it is not true for light.¹⁹ Light, launched from a fast-moving train, will travel at the same speed in all directions. This strange property of light led to the more extensive theory of special relativity.²⁰

Some people give another explanation for why we see distant stars in a young universe. They believe that God created a beam of light between Earth and each star. Of course, a creation would immediately produce completed things. Instantly, they would look much older than they really are. This is called “creation with the appearance of age.” The concept is sound. However, for starlight, this presents two difficulties:

- ◆ Bright, exploding stars are called *supernovas*. If starlight, seemingly from a supernova, had been

created less than 10,000 years ago on its path to Earth and did not originate at the surface of an exploding star millions of light years away, then what exploded? Only a relatively short beam (less than 10,000 light-years long) would have been created near Earth. If the image of an explosion was created on that short beam of light, then the star never existed and the explosion never happened. One finds this hard to accept.

- ◆ Every hot gas radiates a unique set of precise colors, called its *emission spectrum*. The gaseous envelope around each star also emits specific colors that identify the chemical composition of the gas. Because all starlight has emission spectra, this strongly suggests that a star’s light originated at the star—not in cold, empty space. Each beam of starlight also carries other information, such as the star’s spin rate, magnetic field, surface temperature, and the chemical composition of the cold gases between the star and Earth. Yes, God could have created this beam of light with all this information in it. However, the real question is not “Could God have done it?” but “Did He?”

Therefore, starlight seems to have originated at stellar surfaces, not in empty space.

Surprising Observations. Starlight from distant stars and galaxies is redshifted; that is, their light is redder than one might expect. Redshifted light is a wave effect, similar to the lower pitch of a train’s whistle when the train is going away from an observer. As the wave emitter (train or star) moves away from an observer, the waves are stretched, making them lower in pitch (for the train) or redder in color (for the star or galaxy). The greater a star’s or galaxy’s redshift, the faster it is supposedly moving away from us.

Since 1976, William Tifft, a University of Arizona astronomer, has found that distant stars and galaxies have redshifts that typically differ from each other by only a few fixed amounts.²¹ This is very strange if stars are actually moving away from us. It would be as if galaxies could travel only at specific speeds, jumping abruptly from one speed to another, without passing through intermediate speeds. Other astronomers, not initially believing Tifft’s results, did similar work and reached the same conclusion—one that undermines the foundations of cosmology.

All atoms give off tiny bundles of energy (called *quanta*) of fixed amounts—and nothing in between. So, Setterfield believes that the “quantization of redshifts,” as many describe it, is an atomic effect, not a strange recessional-velocity effect. If space slowly absorbs energy from all emitted light, it would do so in fixed increments, which would redshift starlight, with the farthest star’s light red-shifting the most. If the speed of light is decaying, we should soon see the redshifts of a few distant galaxies suddenly decrease. This may explain why two distinct redshifts have been seen in each of several well-studied galaxies;²² they are obviously not flying apart!

Another surprising observation is that most distant galaxies look remarkably similar to nearer galaxies. For example, galaxies are fully developed and show no signs of evolving. This puzzles astronomers.²³ If the speed of light has decreased drastically—or *if space and its light were stretched out during the creation week, as proposed on pages 439–453*—these distant, yet mature, galaxies no longer need explaining. Also, the light from a distant galaxy would have reached Earth not too long after the light from nearby galaxies. This may be why spiral galaxies, both near and far, have similar twists. [See Figure 230.]

A Critical Test. If the speed of light has decreased a millionfold, *we should observe events in outer space in extreme slow motion.* Here is why.

Imagine a time in the distant past when the speed of light was a million times faster than it is today. On a hypothetical planet, billions of light-years from Earth, a light started flashing toward Earth every second. Each flash then began a very long trip to Earth. Because the speed of light was a million times greater than it is today, those

initial flashes were spaced a million times farther apart than they would have been at today's slower speed of light.

Now, thousands of years later, imagine that throughout the universe, the speed of light has slowed to today's speed. The first of those light flashes—strung out like beads sliding down a long string—are approaching Earth. The large distances separating adjacent flashes have remained constant during those thousands of years, so the moving flashes slowed in unison. Because the first flashes to strike Earth are spaced so far apart, they will strike Earth every million seconds. We would see past events on that distant planet (the flashing of a light) in slow motion. If the speed of light has been decreasing since the creation, then the farther out in space we look, the more extreme this slow motion becomes.

About half the stars in our galaxy are binary; that is, each has a companion star. Both stars are in a tight orbit around their common center of mass. *If the speed of light is decreasing, the "slow-motion effect," should show the orbital periods of binaries decreasing with time and increasing with distance from Earth.*

References and Notes

1. Trevor Norman and Barry Setterfield, *The Atomic Constants, Light, and Time* (Box 318, Blackwood, South Australia, 5051: self-published, 1987).
2. Alan Montgomery and Lambert Dolphin, "Is the Velocity of Light Constant in Time?" *Galilean Electrodynamics*, Vol. 4, September–October 1993, pp. 93–97. [This paper is also found at www.ldolphin.org/cdkgal.html.]
3. Two creationist physicists have claimed that the data shows no statistically significant change in the speed of light. See, for example:
 - ◆ Gerald E. Aardsma, "Has the Speed of Light Decayed?" *Impact*, No. 179 (El Cajon, California: The Institute for Creation Research), May 1988.
 - ◆ Gerald E. Aardsma, "Has the Speed of Light Decayed Recently?" *Creation Research Society Quarterly*, Vol. 25, June 1988, pp. 36–40.
 - ◆ Robert H. Brown, "Statistical Analysis of the Atomic Constants, Light and Time," *Creation Research Society Quarterly*, Vol. 25, September 1988, pp. 91–95.

Their calculations contain mathematical errors which, if corrected, would support the hypothesis that the speed of light has decreased. I have discussed these matters with each author. The following professional statisticians have verified my conclusions or have reached similar conclusions independently:

Michael Hasofer, University of New South Wales, Sydney 2033, Australia.

David J. Merkel, 11 Sunnybank Road, Aston, Pennsylvania 19014, U.S.A.
4. M. E. J. Gheury de Bray, "The Velocity of Light," *Science*, Vol. 66, 30 September 1927, Supplement, p. x.
5. M. E. J. Gheury de Bray, "The Velocity of Light," *Nature*, 24 March 1934, p. 464.
- ◆ M. E. J. Gheury de Bray, "The Velocity of Light," *Nature*, 4 April 1931, p. 522.
6. "*The biggest challenge to the standard model of galaxy formation could be the number of large galaxies showing the spiral structure in the early universe.*" Ivo Labbé, as quoted by Ron Cowen, "Mature Before Their Time," *Science News*, Vol. 163, 1 March 2003, p. 139.
7. Ibid.
8. Light beams are considered to be traveling in a vacuum. Light traveling through any substance—such as air, water, or glass—travels at slightly slower speeds.
 - ◆ In two published experiments, the speed of light was exceeded by as much as a factor of 100! The first experiment involved radio signals—a type of light. [See P. T. Pappas and Alexis Guy Obolensky, "Thirty Six Nanoseconds Faster Than Light," *Electronics and Wireless World*, December 1988, pp. 1162–1165.] The second report referred to a theoretical derivation and a simple experiment that allowed electrical signals to greatly exceed the speed of light. This derivation follows directly from Maxwell's equations. The special conditions involved extremely thin electrical conductors with very low capacitance and inductance. [See Harold W. Milnes, "Faster Than Light?" *Radio-Electronics*, Vol. 54, January 1983, pp. 55–58.]

Other phenomena allow light to travel faster or slower than its normal speed. [See Julian Brown, "Faster Than the Speed of Light," *New Scientist*, 1 April 1995, pp. 26–29; Lene Vestergaard Hau et. al., "Light Speed Reduction to 17 Metres per Second in an Ultracold Atomic Gas," *Nature*, Vol. 397, 18 February 1999, pp. 594–598; Jon Marangos, "Faster than a Speeding Photon," *Nature*, Vol. 406, 20 July 2000, pp. 243–244.] However, these effects do not explain distant light in a young universe.

9. V. S. Troitskii, "Physical Constants and the Evolution of the Universe," *Astrophysics and Space Science*, Vol. 139, December 1987, pp. 389–411.
 10. "We have shown how a time varying speed of light could provide a resolution to the well-known cosmological puzzles." Andreas Albrecht and João Magueijo, "A Time Varying Speed of Light as a Solution to Cosmological Puzzles," *Physical Review D*, 15 February 1999, p. 043516-9. [The authors state that light may have traveled thirty orders of magnitude faster than it does today!]
 - ◆ "It is remarkable when you can find one simple idea [a decaying speed of light] that has so many appealing consequences." John D. Barrow, Professor of Astronomy and Director of the Astronomy Centre at the University of Sussex, as quoted by Steve Farrar, "Speed of Light Slowing Down," *London Sunday Times*, 15 November 1998.
 - ◆ "If light initially moved much faster than it does today and then decelerated sufficiently rapidly early in the history of the Universe, then all three cosmological problems—the horizon, flatness and lambda problems—can be solved at once." John D. Barrow, "Is Nothing Sacred?" *New Scientist*, Vol. 163, 24 July 1999, p. 28.
- Each problem Barrow mentions is a reason for concluding the big bang theory is wrong.
11. T. C. Van Flandern, "Is the Gravitational Constant Changing?" *The Astrophysical Journal*, Vol. 248, 1 September 1981, pp. 813–816.
 12. Caroline Ash and Jesse Smith, "How Many Galaxies are in the Universe?" *Science*, Vol. 345, 18 November 2016, p. 845.
 13. F. Duccio Macchetto and Mark Dickerson, "Galaxies in the Young Universe," *Scientific American*, Vol. 276, May 1997, p. 95.
 14. Govert Schilling, "Early Start for Lumpy Universe," *Science*, Vol. 281, 11 September 1998, p. 1593. [See also E. J. Ostrander et al., "The Hubble Space Telescope Medium Deep Survey Cluster Sample: Methodology and Data," *The Astrophysical Journal*, Vol. 116, December 1998, pp. 2644–2658.]
 15. This problem for conventional astronomy has been quietly recognized for several decades.

◆ See Endnote 32 on page 451.

16. See Endnote 55 on page 453 and "Starburst Galaxies" on page 445.
 17. T. C. Van Flandern, "Is the Gravitational Constant Changing?" *Precision Measurement and Fundamental Constants II*, editors B. N. Taylor and W. D. Phillips, National Bureau of Standards (U.S.A.), Special Publication 617, 1984, pp. 625–627.
 18. "Precision" should not be confused with "accuracy." Atomic clocks are very precise, but not necessarily accurate. They keep very consistent time with each other, and each atomic clock can subdivide a second into 9 billion parts. This is remarkable **precision**. But what if this entire global network of atomic clocks is drifting—speeding up or slowing down? Precision, while impressive, is a necessary but not sufficient requirement for accuracy.
 19. Kenneth Brecher, "Is the Speed of Light Independent of the Velocity of the Source?" *Physical Review Letters*, Vol. 39, 24 October 1977, pp. 1051–1054.
 20. Another question concerns Einstein's well-known formula, $E=mc^2$, which gives the energy (E) released when a nuclear reaction annihilates a mass (m). If the speed of light (c) decreases, then one might think that either E must decrease or m must increase. Not necessarily; it depends on how you measure time.
- In the universe, time could flow according to either atomic time or orbital time. Under which standard would $E=mc^2$ be a true statement? Mass-energy would be conserved under both; in other words, the energy or mass of an isolated system would not depend on how fast time passed. Obviously, $E=mc^2$ would be precisely true in atomic time where c is constant, and *approximately* correct in orbital time, because, today, c is apparently changing very slowly.
- Nuclear reactions convert mass to energy. Unfortunately, the extremely small mass lost and large energy produced cannot be measured precisely enough to test whether $E=mc^2$ is absolutely true in orbital time. Even if mass and energy were precisely measured, this formula has embedded in it *an experimentally-derived, unit-conversion factor* that requires a time measurement by some clock. Which type of clock should be used: an orbital clock or an atomic clock? Again, we can see that $E=mc^2$ is "clock dependent."
21. William G. Tifft, "Properties of the Redshift. III. Temporal Variation," *The Astrophysical Journal*, Vol. 382, 1 December 1991, pp. 396–415.
 22. William G. Tifft and W. John Cocke, "Quantized Galaxy Redshifts," *Sky & Telescope*, January 1987, p. 19.
 23. "Most Distant Galaxies: Surprisingly Mature," *Science News*, Vol. 119, 7 March 1981, p. 148.

If the Sun and Stars Were Made on Day 4, What Was the Light of Day 1?

Light from the Sun and other stars is not the only way to illuminate the Earth and produce day-night cycles. The light of Day 1 was a consequence of the instantaneous creation of matter in a much smaller universe.

The Creation Perspective

As explained on page 442 in “**Quasars and Light, the Eddington Limit, Galaxies and Stars, Angular Momentum, and Gravity Waves,**” on Day 1, matter was so close together that powerful gravitational forces began forming quasars. Thus, the universe was filled with extreme light.

Black-Body Radiation. A black body is defined as one which absorbs all incoming radiation. The light emitted from such a body is *black-body radiation*. When light reflects enough times off surrounding matter—as it would early in the creation week, before the much smaller universe was stretched out—everything reached a common temperature and the space between that matter was filled with **black-body radiation**.¹ Days later, after the universe was stretched out, temperatures dropped. [Stretched out space is discussed beginning on page 439: “*Why Is the Universe Expanding?*”]

This black-body radiation was discovered in 1965 and is called the **cosmic microwave background (CMB) radiation**. Its temperature today corresponds to a very cold 2.73 kelvins (-454.76°F).

What did this light look like on Day 1, before the Sun, Moon, and stars were made on Day 4 and before the heavens were stretched out? Blinding light reached Earth from all directions. After the universe was stretched out, light arrived primarily from the direction of the nearest quasar which would soon be at the center of our galaxy. (That quasar has since devoured all nearby matter and is now the black hole with 4.3 million solar masses at the center of our Milky Way galaxy.) Shadows then appeared; light was separated from darkness.

And God separated the light from darkness. (Genesis 1:4b)

Earth, rotating since its creation on Day 1, then experienced day-night cycles even before the Sun was created on Day 4. Today, thousands of years later the CMB reaching Earth is uniformly spread out over the entire sky. This is because black-body radiation uniformly filled the much smaller universe before the heavens were stretched out. Since Day 4, the Sun has been Earth’s dominant light source.

The Big Bang Perspective

The big bang theory has another explanation for the CMB. Within a tiny fraction of a second after the big bang, the universe was about the size of a basketball and was expanding

trillions of billions of times faster than the speed of light today. Matter was so hot that it was a plasma (electrons and nuclei could not combine). Therefore, light, scattered back and forth by all the free electrons, became black-body radiation.

Approximately 400,000 years after the big bang, the universe, still expanding, had cooled enough for electrons and nuclei to combine into atoms. Without interference from free electrons, light in the form of the cosmic microwave background radiation could now be seen.

Smoothness of the CMB

The CMB is so remarkably smooth, that for 25 years after its discovery, no variations could be detected. Increasingly precise instruments were designed and launched into space to look for variations in the CMB’s intensity, because the big bang theory said large variations had to be there if stars and galaxies were to form. Without billions of large concentrations of matter, other matter could not gravitationally contract around those concentrations to form today’s untold billions of galaxies. If stars and galaxies did not form, we would not be here!

Finally, after 25 years of searching, variations amounting to only one part in 100,000 were found. Obviously, with such uniformly dispersed matter, galaxies could not gravitationally form, even over billions of years. Experts recognized this problem.

But this uniformity [in the CMB] is difficult to reconcile with the obvious clumping of matter into galaxies, clusters of galaxies and even larger features extending across vast regions of the universe, such as “walls” and “bubbles.”²

The theorists know of no way such a monster [a massive accumulation of galaxies, called the Great Wall] could have condensed in the time available since the Big Bang, especially considering that the 2.7 K background radiation reveals a universe that was very homogeneous in the beginning.³ Gravity can’t, over the age of the universe, amplify these [tiny] irregularities enough [to form huge clusters of galaxies].⁴

Also, the Hubble Space Telescope has photographed the extreme edges of the visible universe. Most experts expected to see diffuse matter slowly gravitating together to form galaxies. That is what one would expect if the extremely smooth CMB was left over from the big bang. Instead, galaxies were already “bunched together”—having formed very early in the history of the universe.

... tremendously distant galaxies are just as clustered as today and are arranged in the same filamentary, bubbly structures that nearby galaxies are.⁵

*In each of the five patches of sky surveyed by the team, the distant galaxies bunch together instead of being distributed randomly in space. “The work is ongoing, but what we’re able to say now is that galaxies we are seeing at great distances are as strongly clustered in the early universe as they are today,” says [Charles C.] Steidel, who is at the California Institute of Technology in Pasadena.*⁶

Conclusion

Is the CMB left over from the hot big bang, or was radiation emitted following the creation of matter in a much smaller universe? Both choices place the CMB at the beginning of time and attribute the radiation’s current low effective temperature (2.73 kelvins, or -454.76°F) to an expansion of space.

However, the big bang’s explanation for the CMB has several widely recognized problems.

- ◆ The CMB, when viewed over the entire sky, is thousands of times too evenly distributed to have

produced the galaxies we see today, even after billions of years.

- ◆ The most distant galaxies seen are tight clusters of stars—too tightly clustered to have formed so quickly after the rapid expansion of a big bang.
- ◆ The CMB radiation from matter on opposite sides of the universe is identical. However, that matter, according to the big bang theory, was never close enough to have reached thermal equilibrium. But, if the CMB is a natural consequence of the creation of matter within a very compact universe that was later stretched out, identical radiation would be expected.

Furthermore, if one considers the many other problems with the big bang theory, a discussion that begins on page 32, the two choices described here—creation or the big bang—are reduced to one.

One thing is clear: on Day 1, three days before the Sun and all stars were made—or before the creation of all stars was completed⁷—a temporary light source illuminated the spinning Earth and provided day-night cycles.

References and Notes

1. A black body radiates at all wavelengths, but each wavelength’s intensity depends on only the body’s temperature. Perfect blackbodies do not exist, because all matter (solids, liquids, gases, and plasmas) radiates at preferred wavelengths. However, blackbodies can be approximated in the laboratory.
2. Ivars Peterson, “Seeding the Universe,” *Science News*, Vol. 137, 24 March 1990, p. 184.
3. M. Mitchell Waldrop, “The Large-Scale Structure of the Universe Gets Larger—Maybe,” *Science*, Vol. 238, 13 November 1987, p. 894.
4. Margaret Geller, as quoted by John Travis, “Cosmic Structures Fill Southern Sky,” *Science*, Vol. 263, 25 March 1994, p. 1684.
5. Michael A. Straus, “Reading the Blueprints of Creation,” *Scientific American*, Vol. 290, February 2004, p. 61.
6. Ron Cowen, “Light from the Early Universe,” *Science News*,

Vol. 153, 7 February 1998, p. 92.

7. Stars and other heavenly bodies may not have all been made on a single day (Day 4); instead, they may have been *completed* on Day 4. Keil and Delitzsch, in analyzing the Hebrew words in Genesis 1, feel strongly that Day 4 marks the *completion* of the heavenly bodies: “the words can have no other meaning than that their creation was completed on the fourth day.” [See C. F. Keil and F. Delitzsch, *Commentary on the Old Testament in Ten Volumes*, Vol. 1 (reprint, Grand Rapids: Eerdmans Publishing Co., 1981), p. 59.]

This is consistent with the Bible verses and scientific evidence discussed in [“Why Is the Universe Expanding?”](#) on page 439. Before the heavens were stretched out on Day 4, gravity could act much more powerfully, because the universe was so compact. Stars, black holes, and galaxies would form. Galaxies would collide, and stars and galaxies would achieve velocities that, today, baffle most astronomers.

How Old Do Evolutionists Say the Universe Is?

In the late 1920s, evolutionists believed that the universe was 2-billion years (b.y.) old. Later, radiometric dating techniques gave much older ages for certain rocks on Earth.¹ Obviously, a part of the universe cannot be older than the universe itself. This contradiction was soon removed by devising a rationale for increasing the age of the universe.

Similar problems are now widely acknowledged. [See [“Big Bang?”](#) on page 32.] If a big bang occurred, it happened

13.7 b.y. ago. If stars evolved, some stars are 16 b.y. old, such as the stars in the globular cluster in Figure 233.² Obviously, stars cannot be older than the universe. Also, the Hubble Space Telescope has found distant galaxies too old (based on big bang assumptions) to fit in a younger universe.³

Here is a similar, but less widely known, problem. Let’s suppose that the universe is 13.7 b.y. old. That is not enough time for stars *containing heavy chemical elements* to

form and then transmit their light all the way to Earth. A big bang would have produced only hydrogen, helium, and lithium—the three lightest chemical elements. Light from some of the most distant stars and galaxies shows that they contain much heavier chemical elements, such as carbon, iron, and lead—elements that could not have been in the first generation of stars to form after the big bang. Evolutionists therefore believe that the hundred or so heavier chemical elements (97% of all chemical elements) were produced either deep inside stars or when some stars exploded as supernovas. Much later, a second generation of stars supposedly formed with the heavy elements from that exploded debris.

Big bang advocates and physicists have struggled to explain the origin of the heavier chemical elements (carbon, oxygen, iron, lead etc.). [See Endnote 33 on page 142.] To squeeze enough hydrogen nuclei together to form some other light elements supposedly requires the high temperatures inside stars. To form elements heavier than iron, they say, requires something even hotter—a supernova. But this too will not work. [See Endnotes 116–118, beginning on page 429.]



Figure 233: Globular Cluster. Globular clusters are tight, spherical concentrations of 10,000–1,000,000 stars. This globular cluster, called M13, is about 22,000 light-years away. To see why all the stars in a globular cluster did not evolve but came into existence about the same time, see “**Star Births? Stellar Evolution?**” on page 34.

So, if a big bang happened, there would not be enough time afterward to complete all four of the following:

- Form the first generation of stars out of hydrogen, helium, and lithium.
- Have many of those stars quickly⁴ pass through their complete life cycles then finally explode as supernovas to produce the heavier chemical elements.
- Recollect, somehow, enough of that exploded debris—presumably containing heavy elements—to form second generation stars. (Some were quasars which are powered by black holes, *billions of times more massive than our Sun!*) [See Endnote 23 on page 451.]
- Transmit the light from these heavy elements to Earth, immense distances away.

Sophisticated light-gathering instruments have allowed astronomers to discover heavy elements in many extremely distant galaxies⁵ and quasars.⁶ If the speed of light has been constant, that quasar’s light has taken 95% of the age of the universe to reach us. This means that only the first 5% of the age of the universe (only 0.7 b.y.) was available for events a–c above. Few astronomers believe that such slow processes as a–c above, if they happened at all, could happen in 0.7 b.y.⁷

Evolutionists can undoubtedly resolve these time contradictions—but at the cost of rejecting some cherished belief. Perhaps they will accept the possibility that light traveled much faster in the past. More than 160 measurements collected over 300 years by dozens of researchers support this revolutionary idea. [See page 454.] Maybe they will conclude that the big bang never occurred, or that heavy elements were somehow in the first and only generation of stars, or that stars degrade, but new stars don’t evolve. Much evidence supports each of these ideas, and all are consistent with a recent creation.

Few evolutionists are aware of these contradictions. However, as more powerful telescopes begin peering even farther into space, these problems will worsen and more attention will be focused on them. If scientists find, as one might expect, even more distant stars and galaxies with heavy elements, problems with the claimed age of the universe will no longer be the secret of a few evolutionists.⁸

References and Notes

- Arthur N. Strahler, *Science and Earth History* (Buffalo, New York: Prometheus Books, 1987), pp. 102, 129.
- Ivan R. King, “Globular Clusters,” *Scientific American*, Vol. 252, June 1985, pp. 79–88.
- ◆ “*This [age of the universe] is flatly inconsistent with the ages of Galactic globular clusters, estimated to be about 13–17 Gyr [billion years].*” Robert C. Kennicutt Jr., “A Meeting of Hubble Constants,” *Nature*, Vol. 381, 13 June 1996, p. 555.
- ◆ “*Even the most enthusiastic cosmologist will admit that current theories of the nature of the universe have some big holes. One such gap is that the universe seems to be younger than some of the objects contained within it.*” Robert Matthews, “Spoiling a Universal ‘Fudge Factor,’” *Science*, Vol. 265, 5 August 1994, pp. 740–741.
- ◆ “*A mature galaxy has been discovered in an early phase of the Universe apparently too young to contain it.*” Robert C. Kennicutt Jr., “An Old Galaxy in a Young Universe,” *Nature*, Vol. 381, 13 June 1996, p. 555.

- ◆ James Dunlop, “A 3.5-Gyr-Old Galaxy at Redshift 1.55,” *Nature*, Vol. 381, 13 June 1996, pp. 581–584.

4. For this to happen quickly, evolutionists must assume that the first stars were giants, more than a hundred times larger than the Sun. (Theoretically, more massive stars would burn faster.) Thus, textbooks confidently say that the first stars were giants.

No one *knows* that the first stars were giants, but it’s a required, unverified assumption if stars evolved. Also, if stars evolved, some characteristics of the light from the first generation of stars is missing. [See Piero Madau, “Trouble at First Light,” *Nature*, Vol. 440, 20 April 2006, pp. 1002–1003.]

- 5. *“This galaxy’s colors are consistent with significant metal content, implying that galaxies become enriched rapidly.”* S. L. Finkelstein et. al., “A Galaxy Rapidly Forming Stars 700-Million Years after the Big Bang at Redshift 7.51,” *Nature*, Vol. 502, 26 October 2013, p. 524.
- ◆ *“For one, the galaxy seems to be significantly rich in ‘metals’—elements heavier than hydrogen and helium. Because all of those elements [supposedly] originate from fusion reactions in the heart of stars and are spewed out when those stars explode as supernovae, the relatively high metallicity of the galaxy suggests that it had already seen the birth and death of generations of stars by the time the universe was 700 million years old.”* Yudhijit Bhattacharjee, “Earliest Known Galaxy Formed Stars at a Breakneck Pace,” *Science*, Vol. 342, 25 October 2013, p. 411.

How did they calculate the “breakneck” star formation rate? By assuming the big bang.

This galaxy, named z8_GND_5296, is bright, so they can estimate the number of stars in it. Because its stars contain heavy elements, it must have formed after generations of other stars somehow evolved, lived through their life cycle, and exploded. All of this had to happen in less than 700-million years *after the assumed big bang*. Dividing the estimated number of stars by the relatively short time period available gives a ridiculously high rate of star formation, which is orders of magnitude greater than that estimate for our Milky Way Galaxy.

- ◆ James Glanz, “CO in the Early Universe Clouds Cosmologists’ Views,” *Science*, Vol. 273, 2 August 1996, p. 581.
- ◆ *“The presence of these [25] elements, particularly those heavier than iron, in such a young [distant] galaxy is striking. Fundamentally, it seems to indicate that in the galaxies (or at*

least in this galaxy) that formed relatively shortly after the Big Bang, the onset of star formation and related element production was very rapid.” John Cowan, “Elements of Surprise,” *Nature*, Vol. 423, 1 May 2003, p. 29.

- ◆ Jason X. Prochaska et al., “The Elemental Abundance Pattern in a Galaxy at $z=2.626$,” *Nature*, Vol. 423, 1 May 2003, pp. 57–59.
- 6. *“According to standard models [all based on the big bang theory], the first stars needed at least 500 million years to begin lighting up and another 700 million to 1 billion years to manufacture heavy elements such as iron and spread them through space. [Wolfram] Freudling therefore expected that gas around the quasars, which were shining when the universe was just 900 million years old, would be metal-free. [Astronomers call the hundred or so heavier chemical elements “metals.”] Instead, he and his colleagues found the quasars are surrounded by copious amounts of iron.”* Kathy A. Svitil, “Signs of Primordial Star Ignition Detected,” *Discover*, January 2004, p. 66.
- ◆ *“... quasar environments are metal rich at all redshifts.”* F. Hamann et al., “Quasar Elemental Abundances and Host Galaxy Evolution,” *Origin and Evolution of the Elements*, Vol. 4, editors A. McWilliam and M. Rauch (Cambridge, England: Cambridge University Press, 2003), p. 12.
- ◆ Ohta et al., “Detection of Molecular Gas in the Quasar BR 1202-0725 at Redshift $z = 4.69$,” *Nature*, Vol. 382, 1 August 1996, pp. 426–431.
- ◆ *“First, the chemical composition of quasars hints at early enrichments, indicative of star formation. Emission lines in the quasar spectrum can be used to measure their abundance of heavy elements, or ‘metallicity.’ Luminous, high-redshift quasars have roughly solar or higher metallicity, even at redshifts > 6 , indicating that they existed in a metal-rich environment similar to that found in the centers of massive galaxies.”* Xiaohui Fan, “Black Holes at the Cosmic Dawn,” *Science*, Vol. 300, 2 May 2003, p. 752.
- 7. Jeff Kanipe, “Galaxies at the Confusion Limit,” *Astronomy*, December 1988, pp. 56–58.
- ◆ R. F. Carswell, “Distant Galaxy Observed,” *Nature*, Vol. 335, 8 September 1988, p. 119.
- 8. Dietrick E. Thomsen, “Farthest Galaxy Is Cosmic Question,” *Science News*, Vol. 133, 23 April 1988, pp. 262–263.
- ◆ M. Mitchell Waldrop, “Pushing Back the Redshift Limit,” *Science*, Vol. 239, 12 February 1988, pp. 727–728.

What Was *Archaeopteryx*?

If dinosaurs (or, as some evolutionists assert, reptiles) evolved into birds, thousands of types of animals should have been more birdlike than dinosaurs and yet more dinosaur-like than birds. Evolutionists claim *Archaeopteryx* (ark-ee-OP-ta-riks) is a feathered dinosaur, a transition between dinosaurs (or reptiles) and birds. Of the few claimed intermediate fossils, *Archaeopteryx* is the one most frequently cited by evolutionists and shown in most biology textbooks. Some say the few claimed *Archaeopteryx* fossils are the most famous fossils in the world.

Archaeopteryx means ancient (*archae*) wing (*pteryx*). But the story behind this alleged half-dinosaur, half-bird is much more interesting than its fancy, scientific-sounding name or the details of its bones. If *Archaeopteryx* were shown to be a fraud, the result would be devastating for the evolution theory.

Since the early 1980s, several prominent scientists have charged that the two *Archaeopteryx* fossils with clearly visible feathers (the Berlin and London specimens) are forgeries.¹ Allegedly, thin layers of cement were spread on the mating surfaces (slab and counterslab) of two fossils of a chicken-size dinosaur, called *Compsognathus* (komp-SOG-na-thus). Bird feathers were then imprinted into the wet cement.

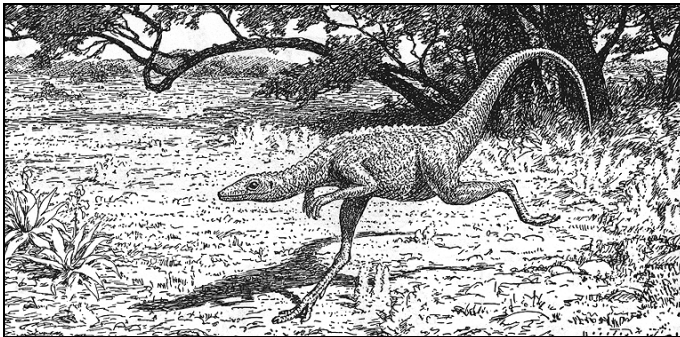

Figure 234: *Compsognathus*. While most dinosaurs were large, this one, *Compsognathus longipes*, was small—about the size of a chicken. The German scientist who discovered *Compsognathus*, Andreas Wagner, “recognized from the description [of *Archaeopteryx*] what seemed to be Wagner’s *Compsognathus* but with feathers! He was extremely suspicious ...”² *Compsognathus* and *Archaeopteryx* are quite similar. *Compsognathus* fossils are also found at the same site in Germany where *Archaeopteryx* was found.

If *Archaeopteryx* did not have a few modern, aerodynamic feathers (clearly visible on two of the known specimens³), it would be considered *Compsognathus*.⁴ The skeletal features of *Archaeopteryx* are not suitable for flight, because no specimen shows a sternum (breast bone), which all birds and bats must have to anchor their large flight muscles. Why would *Archaeopteryx* have modern, aerodynamically perfect feathers if it could not fly? Finally, after 150 years of filling textbooks and training teachers with false

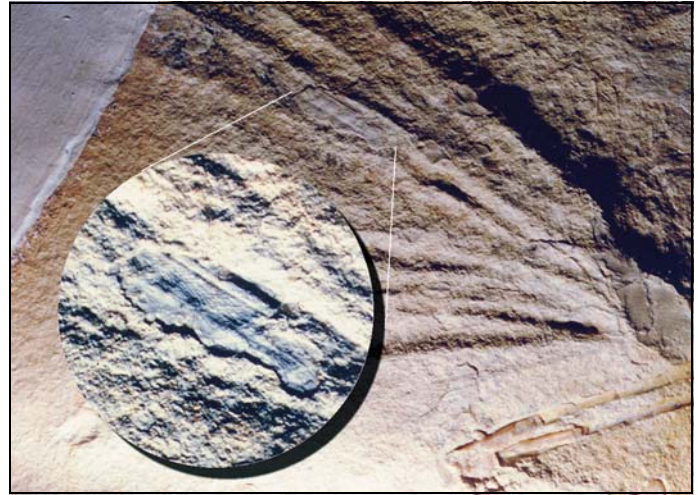

Figure 235: “Chewing-Gum Blob.” These raised spots have the appearance of pieces of chewing gum. They have no corresponding indentation on the mating face of the fossil. Possibly some small drops of wet cement fell on the surface and were never detected or cleaned off by the forger.

information, two prestigious science journals announced that *Archaeopteryx* should not be classified as a bird.⁵

The two fossils with true feathers were “found” and sold for high prices by Karl Häberlein (in 1861 for 700 pounds) and his son, Ernst (in 1877 for 20,000 gold marks), just as Darwin’s theory and book, *The Origin of Species* (1859), were gaining popularity. While some German experts thought that the new (1861) fossil was a forgery, the British Museum (Natural History) bought it sight unseen. (In the preceding century, fossil forgeries from limestone quarries were common in that region of Germany.⁶)

Evidence of an *Archaeopteryx* forgery includes instances where the slab and counterslab do not mate. The feather impressions are primarily on the main slab, while the counterslab in several places has raised areas with no corresponding indentation on the main slab. These raised areas, nicknamed “chewing-gum blobs,” are made of the same fine-grained material that is found only under the feather impressions. The rest of the fossil is composed of a coarse-grained limestone. [See [Figure 235](#).]

Some might claim that *Archaeopteryx* has a wishbone, or furcula—a unique feature of birds. It would be more accurate to say that only the British Museum specimen has a visible, but strange, furcula—“relatively the largest known in any bird.”⁷ Furthermore, it is upside down, a point acknowledged by two giants of the evolutionist movement—T. H. Huxley (Darwin’s so-called bulldog) and Gavin deBeer. As Fred Hoyle and N. Chandra Wickramasinghe stated,

It was somewhat unwise for the forgers to endow Compsognathus with a furcula, because a cavity had to

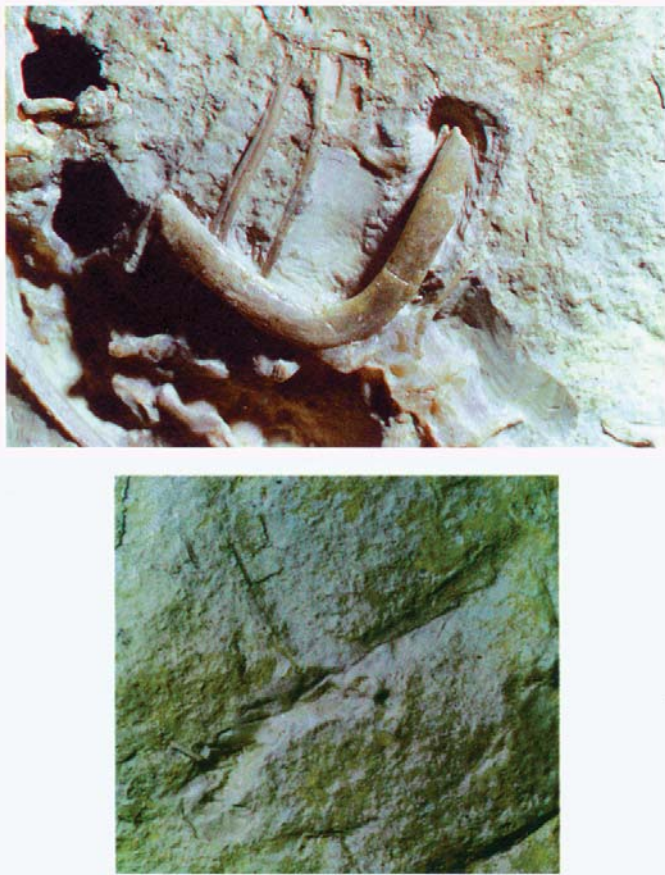

Figure 236: Furcula of *Archaeopteryx*? This V-shaped bone is claimed to be the wishbone, or furcula, of *Archaeopteryx*. It is shaped more like a boomerang than the familiar wishbone in a chicken. A furcula acts as a spring—storing and releasing energy with each up and down wing flap. Notice the crack in the right arm of the furcula and the broken right tip—strange for a bird’s flexible bone buried in soft sediments. Perhaps it broke when a forger chipped it out of another fossil. One must ask why only this British Museum specimen shows a clear furcula. Notice how the counterslab (bottom picture) does not have a correspondingly smooth depression into which the raised furcula will fit.

*be cut in the counterslab, with at least some semblance to providing a fit to the added bone. This would have to be done crudely with a chisel, which could not produce a degree of smoothness in cutting the rock similar to a true sedimentation cavity.*⁸ [See [Figure 236](#).]

Feather imprints show what have been called “double strike” impressions. Evidently, feather impressions were made twice in a slightly displaced position as the slab and counterslab were pressed together. [See [Figure 237](#).]

Is *Archaeopteryx* a forgery? Honest disagreements were possible until 1986, when a definitive test was performed. An x-ray resonance spectrograph of the British Museum fossil showed that the finer-grained material containing the feather impressions differed significantly from the rest of the coarser-grained fossil slab. The chemistry of this “amorphous paste” also differed from the crystalline rock in the famous fossil quarry in Bavaria, Germany, where *Archaeopteryx* supposedly was found.⁹ Few responses have

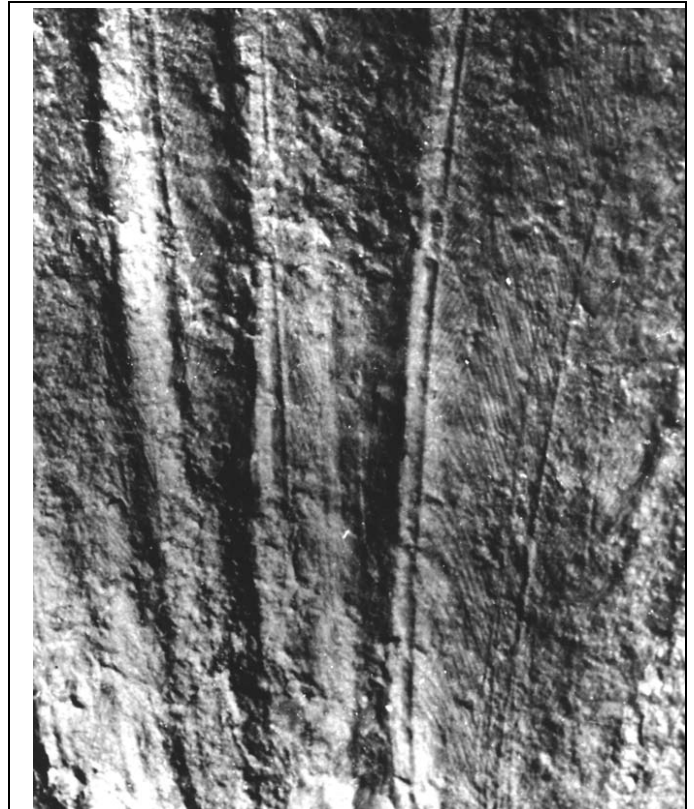

Figure 237: Double Strike. A forger would have a delicate task positioning the counterslab on top of the slab with a cement paste between the two slabs. The two halves of the fossil must mate perfectly. A last-minute adjustment or slip would create a double strike.

been made to this latest, and probably conclusive, evidence.¹⁰

Fossilized feathers from any animal are almost unknown,¹¹ and several complete, *flat* feathers that just happened to be at the slab/counterslab interface are even more remarkable. If a feathered *Archaeopteryx* had been buried in mud or a limestone paste, its feathers would have had a three-dimensional shape, typical of the curved feathers we have all held. Indeed, the only way to flatten a feather is to press it between two flat slabs. Flattened feathers, alone, raise suspicions.

Also, there has been no convincing explanation for how to fossilize (actually encase) a bird in the 80% pure, Solnhofen limestone. One difficulty, which will be appreciated after reading about liquefaction on pages 195–213, is the low density of bird carcasses. Another is that limestone is primarily precipitated from seawater, as explained on pages 260–266. Therefore, to be buried in limestone, the animal must lie on the seafloor—unusual for a dead bird. Other problems with evolving birds are described in Endnote [i](#) on page 67.

While not addressing charges that *Archaeopteryx* status as a bird was based on faked evidence (that fooled the evolutionist community, textbook writers, and students for 150 years), leading paleontologists are coming to the conclusion that *Archaeopteryx* is a dinosaur. “It isn’t a bird after all!”¹² This is based on other fossils found that are definitely two-legged dinosaurs (similar to those

seen in the film *Jurassic Park*). These fossils have too many characteristics in common with *Archaeopteryx*.¹³ Lawrence Witmer, a paleontologist at Ohio University put it this way: “We now really need to accept the fact that *Archaeopteryx* probably isn’t a bird.”¹⁴

When the media popularize an evolutionist claim that is later shown to be false, retractions are seldom made. One refreshing exception is provided by *National Geographic*, which originally, and incorrectly, reported the discovery in China of “a true missing link in the complex chain that connects dinosaurs to birds.” (Actually, the fossil was a composite of a bird’s body and a dinosaur’s tail, faked for financial gain.)¹⁵ Details were explained on a few back pages of *National Geographic* by an independent investigator at the request of *National Geographic*’s editor. The report stated:

*It’s a tale of misguided secrecy and misplaced confidence, of rampant egos clashing, self-aggrandizement, wishful thinking, naive assumptions, human error, stubbornness, manipulation, backbiting, lying, corruption, and, most of all, abysmal communication.*¹⁶

Such fiascoes are common among those seeking rewards and prestige for finding fossils of missing links. Fake fossils, especially from China,¹⁷ have propped up evolutionary stories for decades. The media and museums that popularize these stories mislead the public.

Archaeopteryx’s fame seems assured, not as a transitional fossil between dinosaurs (or reptiles) and birds, but as a forgery. Unlike the Piltdown hoax, which fooled leading scientists for more than 40 years, the *Archaeopteryx* hoax has lasted for 150 years. [See “**Ape-Men?**” on page 13.] Because the apparent motive for the *Archaeopteryx* deception was money, *Archaeopteryx* should be labeled as a *fraud*. The British Museum (Natural History) gave life to both deceptions and must assume much of the blame. Those scientists who were too willing to fit

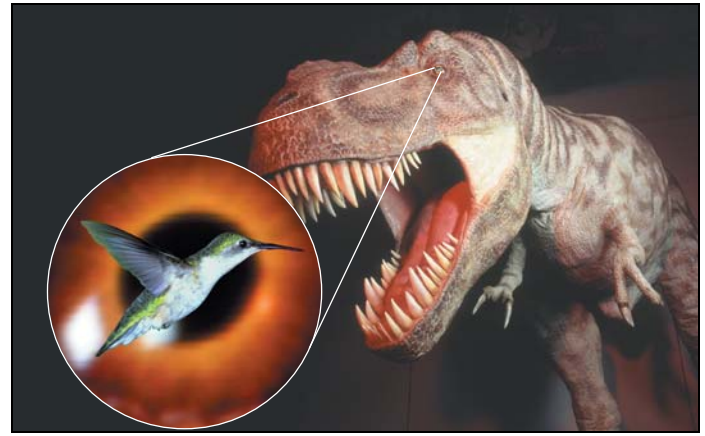

Figure 238: Birds from Dinosaurs? Birds have many marvelous and unique features: flight, feathers, energy efficiency, navigational abilities, brittle eggs, amazing eyesight, and lightweight construction. If birds evolved, from where did they come? Evolutionists try to solve this recognized dilemma¹⁸ by claiming that birds evolved from dinosaurs¹⁹ or that they are “cousins.” *Archaeopteryx* is a prime exhibit for both views. Yes, dinosaurs have some features in common with birds, especially aspects of their bone structure, but birds have many characteristics that dinosaurs do not have. No doubt, more will be discovered.

Another possibility is that a designer gave both birds and dinosaurs some common features, because each had similar needs. For example, gears are common to cars, bicycles, windmills, and watches. Everyone knows they were designed. No one teaches, advocates, or even considers that windmills turned into cars or watches. Efficiency dictates design similarities. How could anyone think dinosaurs evolved into hummingbirds? Time, mutations, and natural selection? Nonsense.

Archaeopteryx into their evolutionary framework also helped spread the deception. *Archaeopteryx* may soon replace Piltdown man as the most famous hoax in all of science.

References and Notes

1. Dr. Lee Spetner first made this allegation in a meeting of orthodox Jewish scientists held in Jerusalem in July 1980. Spetner studied the British Museum specimen in June 1978 and explained the discrepancies to Dr. Alan Charig, the museum’s Chief Curator of Fossil Amphibians, Reptiles, and Birds. [See “Is the *Archaeopteryx* a Fake?” *Creation Research Society Quarterly*, Vol. 20, September 1983, pp. 121–122.] Charig has consistently denied a forgery. Fred Hoyle and N. Chandra Wickramasinghe provide color photographs and the most complete description of this evidence of a fraud in *Archaeopteryx, the Primordial Bird: A Case of Fossil Forgery* (Swansea, England: Christopher Davies, Ltd., 1986). This book also responds to counterclaims that *Archaeopteryx* was not a forgery.
2. Ian Taylor, “The Ultimate Hoax: *Archaeopteryx* Lithographica,” *Proceedings of the Second International Conference on Creationism*, Vol. 2 (Pittsburgh, Pennsylvania: Creation Science Fellowship, 1990), p. 280.
3. Some claim that three other specimens also have feathers—the Teyler Museum specimen, the Eichstätt specimen, and the poorly preserved Maxberg specimen. Hoyle, Wickramasinghe, and Watkins put it bluntly. “*Only people in an exceptional condition of mind can see them.*” [F. Hoyle, N. C. Wickramasinghe, and R. S. Watkins, “*Archaeopteryx*,” *The British Journal of Photography*, 21 June 1985, p. 694.]
4. “... *these specimens* [of *Archaeopteryx*] *are not particularly like modern birds at all. If feather impressions had not been preserved in the London and Berlin specimens, they* [the other specimens] *never would have been identified as birds. Instead, they would unquestionably have been labeled as coelurosaurian dinosaurs* [such as *Compsognathus*]. *Notice that the last three specimens to be recognized* [as *Archaeopteryx*] *were all misidentified at first, and the Eichstätt specimen for 20 years was thought to be a small specimen of the dinosaur Compsognathus.*” John H. Ostrom, “The Origin of Birds,” *Annual Review of Earth and Planetary Sciences*, Vol. 3, 1975, p. 61.

- ◆ “*Apart from the proportions of its wings, the skeleton of Archaeopteryx is strikingly similar to that of a small, lightly built, running dinosaur, such as the coelurosaur Compsognathus.*” Dougal Dixon et al., *The Macmillan Illustrated Encyclopedia of Dinosaurs and Prehistoric Animals* (New York: Macmillan Publishing Co., 1988), p. 172.
- 5. “*It’s been a good run for Archaeopteryx. For the past 150 years, the famous feathered fossil species from Bavaria in Germany has been a symbol of evolution, a textbook example of a transitional fossil and, above all, the oldest and most primitive bird. On page 465 of this issue, however, Xu and colleagues present a newly discovered Archaeopteryx-like species named Ziaotingia zhengi that rearranges the branches on the phylogenetic tree of bird-like theropod dinosaurs, knocking Archaeopteryx (Fig. 1) off its celebrated perch and moving it and its kin into the great unwashed ranks of ‘non avian’ dinosaurs.*” Lawrence M. Witmer, “An Icon Knocked from Its Perch,” *Nature*, Vol. 458, 28 July 2011, p. 458.
- ◆ “*Phylogenetic analysis of stem-group birds reveals that Archaeopteryx is no more closely related to modern birds than are several types of theropod dinosaurs, including tyrannosaurids and ornithomimids. Archaeopteryx is not an ancestral bird, nor is it an ‘ideal intermediate’ between reptiles and birds. There are no derived characters uniquely shared by Archaeopteryx and modern birds alone; consequently there is little justification for continuing to classify Archaeopteryx as a bird.*” R. A. Thulborn, “The Avian Relationships of Archaeopteryx and the Origin of Birds,” *Zoological Journal of the Linnean Society*, Vol. 82, 1984, p. 119.
- 6. Herbert Wendt, *Before the Deluge* (Garden City, New York: Doubleday & Co., Inc., 1968), pp. 40–57.
- 7. Larry D. Martin, “The Relationship of Archaeopteryx to Other Birds,” *The Beginnings of Birds: Proceedings of the International Archaeopteryx Conference of 1984* (Eichstätt, Germany: Jura Museum, 1985), p. 182.
- 8. Hoyle and Wickramasinghe, *Archaeopteryx, the Primordial Bird: A Case of Fossil Forgery*, p. 93.
- 9. N. Wickramasinghe and F. Hoyle, “Archaeopteryx, the Primordial Bird?” *Nature*, Vol. 324, 18/25 December 1986, p. 622.
- 10. Two milligram-size samples of the fossil material were tested, one from a “feather” region and a control sample from a nonfeathered region. The British Museum “*contends that the amorphous nature of the feathered material is an artifact explainable by preservatives that they have put on the fossil.*” [Lee M. Spetner, “Discussion,” *Proceedings of the Second International Conference on Creationism* (Pittsburgh, Pennsylvania: Creation Science Fellowship, 1990), p. 289.] If this excuse were correct, why were no “preservatives” found on the control specimen? Control specimens are tested for precisely this purpose—to dispel unique, last-minute excuses. The British Museum has refused further testing, a shocking position for a scientific organization, and one which raises suspicions to the breaking point.
- 11. “*Exactly 1 year ago, paleontologists were abuzz about photos of a so-called ‘feathered dinosaur,’ ... But at this year’s vertebrate paleontology meeting in Chicago late last month, the verdict was a bit different: The structures are not modern feathers, say the roughly half-dozen Western paleontologists who have seen the specimens. [Instead, they are ‘bristlelike fibers.’]*” Ann Gibbons, “Plucking the Feathered Dinosaur,” *Science*, Vol. 278, 14 November 1997, p. 1229.
- ◆ Some have claimed that dinosaurs had feathers. Alan Feduccia, a bird expert and evolutionist, when asked about this replied:

People have accepted that these filamentous structures—dino fuzz—represent proto-feathers. But these things do not resemble feathers, and I don’t think they have anything to do with feathers. To me, they look like preserved skin fibers. Alan Feduccia, “Plucking Apart the Dino-Birds,” *Discover*, Vol. 24, February 2003, p. 16.
- 12. Michael Balter, “Bad Birthday News for First Bird?” *Science*, Vol. 333, 29 July 2011, p. 511.
- 13. Xing Xu et al., “An Archaeopteryx-Like Theropod from China and the Origin Of Avialae,” *Nature*, Vol. 475, 28 July 2011, pp. 465–470.
- 14. Balter, p. 511.
- 15. “*The ‘Archaeoraptor’ fossil, once proclaimed as a key intermediate between carnivorous dinosaurs and birds but now known to be a forgery, is a chimaera formed of bird and dromaeosaur parts.*” Zhonghe Zhou et al., “Archaeoraptor’s Better Half,” *Nature*, Vol. 420, 21 November 2002, p. 285.
- ◆ Xing Xu, “Feathers for T. Rex?” *National Geographic*, Vol. 197, March 2000, Forum Section.
- 16. Lewis M. Simons, “Archaeoraptor Fossil Trail,” *National Geographic*, Vol. 198, October 2000, p. 128.
- 17. “*Specialists and collectors around the world have long decried the flood of sham fossils pouring out of China.*” Richard Stone, “Altering the Past: China’s Faked Fossils Problem,” *Science*, Vol. 330, 24 December 2010, p. 1740.
- ◆ Michael Balter, “Authenticity of China’s Fabulous Fossils Gets New Scrutiny,” *Science*, Vol. 340, 7 June 2013, pp. 1153–1154.
- 18. “*The issue of bird origins continues to occupy center stage among scientists because these animals differ in so many ways from their flightless antecedents, making avian evolution a critical problem to solve.*” Richard Monastersky, “A Fowl Flight,” *Science News*, Vol. 152, 23 August 1997, p. 120.
- 19. “*And let us squarely face the dinosauriness of birds and the birdness of the Dinosauria. When the Canada geese honk their way northward, we can say: ‘The dinosaurs are migrating, it must be spring!’*” Robert T. Bakker, *The Dinosaur Heresies* (New York: William Morrow and Co., Inc., 1986), p. 462.

What Are the Predictions of the Hydroplate Theory?

Predictions of the hydroplate theory are summarized below. Confirmed predictions are in bold, and a partially missed prediction (prediction 58) is in italics. Page numbers, where more information can be found, are in parentheses.

1. super-rotation in atmosphere of Venus(128)
- 2. pooled water under mountains (134)**
3. salty water in very deep granite cracks (134)
4. many fossilized whales at the base of Andes (137)
- 5. deep channels under Bosphorus and Gibraltar (140)**
6. fracture zones mark high magnetic intensity (148)
7. magnetic strength grows at hydrothermal vents (148)
8. Earth is shrinking (162)
9. earthquakes will be predicted (164)
10. granite layer deep under Pacific floor (170)
11. shallow-water fossils in and near trenches (170)
12. inner core's spin is decelerating (185)
13. age sequences wrong for Hawaiian islands (189)
14. thin, parallel, extensive varves not under lakes (201)
15. sand dunes from Grand Canyon (233)
16. unique chemistry of Grand and Hopi Basins (236)
17. slot canyons have cracks that are miles deep (238)
18. Grand Canyon's inner gorge is a tension crack (240)
19. fault under East Kaibab monocline (254)
20. loess at bottom of ice cores (282)
21. muck on Siberian plateaus (282)
22. rock ice is salty (282)
23. carbon dioxide bubbles in rock ice (283)
24. muck particles in rock ice (283)
25. no fossils below mammoths (283)
26. radiocarbon dating mammoths (284)
27. ice age can be demonstrated (298)
28. comet ice will contained dissolved CO2 (308)
- 29. salt on Mars (314)**
30. moons around some comets (314)
31. mass of solar system is heavier than expected (317)
32. a few comets reappear unexpectedly (317)
33. excess heavy hydrogen in 5+-mile-deep water (318)
34. salt and bacteria in comets (318)
35. Oort cloud does not exist (328)
36. no incoming hyperbolic comets (328)
37. more argon in comet crust (329)
- 38. asteroids are flying rock piles (338)**
- 39. rocks on asteroids and comets are rounded (338)**
40. rapidly spinning asteroids are well-rounded (338)
41. asteroid rocks are magnetized (343)
42. deuterium on Themis (344)
- 43. water is inside large asteroids (344)**
44. mining asteroids too costly (344)
45. Deimos has a very low density (347)
46. Mars' sediments deposited through air (356)
47. heavy hydrogen in space ice (356)
48. many more TNOs have rings (357)
49. Planet X will not be found by January 2021 (364)
50. comets are rich in oxygen-18 (411)
51. lineaments correlate with earthquakes (412)
52. little radioactivity on Moon, Mars (415)
53. new telescopes will not find reionization of IGM (441)
- 54. carbon-14 in "old" bones (508)**
55. bacteria on Mars (531)
56. some hydrogen missing from polonium halos (607)
57. Comets, formed as described by the hydroplate theory, delivered lots of liquid water to Mars. (374)
58. *spin rate and direction of Ceres (368)*

What Triggered the Flood?

At the end of the creation week, all that God created was “*very good*” (Genesis 1:31), so the flood was *not inevitable* at that time. In other words, **the Earth was not created with a “ticking time bomb”—a bad condition.** Nor was the universe created with killer comets, asteroids, or meteoroids aimed at Earth. Their presence at the end of the creation week also would not have been “*very good*.”

Indeed, most natural disasters are a consequence of the flood: volcanic eruptions, earthquakes, tsunamis, lightning strikes, storms (tornadoes, hurricanes, etc.), local floods, droughts, landslides, and impacts by comets, asteroids, and meteorites. [Pages 301–373 explain how comets, asteroids, and meteorites are a consequence of the flood.] Even mutations and other cellular damage caused by radioactive decay are a consequence of the flood. The origin of Earth’s radioactivity is explained on pages 379–433. The index will help you locate explanations explaining why these natural disasters are a consequence of the flood.

Because of the depth of man’s sin¹ (Genesis 6:5–6), the Earth was destroyed by a flood. We may never know with certainty what physical chain of events initiated the flood, but the Bible gives some intriguing clues and narrows the possibilities.

The hydroplate theory, summarized on pages 111–151, shows how a global flood, corresponding in every detail to the Genesis flood, easily explains 25 otherwise mysterious features of the Earth and solar system. This theory postulates that a layer of water was below the crust of the preflood Earth. The Bible tells us that the newly created Earth had considerable subterranean water (see page 489).

Rock Movement. First, visualize an important feature of the newly created Earth. Imagine the entire Earth’s surface covered by a sandwich arrangement in which a horizontal layer of rock (which will become the Earth’s crust) has a layer of water above and below it. The rock layer is about 60-miles thick; each water layer is about 1 mile thick. The water above this rock layer will become surface water; the confined water below is subterranean water. If the rock layer were perfectly uniform in thickness and density, everything would be in balance. Equilibrium would exist.

Undoubtedly, variations existed in the rock’s thickness and density. Heavier parts would sag downward, like an overloaded floor, causing additional surface water to flow into each depression. That added weight would increase each sag, so more surface water would flow into the growing depressions, driving them even deeper, and making contact with the chamber’s floor in many places.²

Pillars. Some sagging rock would also have been *squeezed* downward through the subterranean water, forming protrusions—or “pillars”—pressed against the chamber floor. That was because the pressure within the rock at the base of the rock layer’s thicker, denser portions would

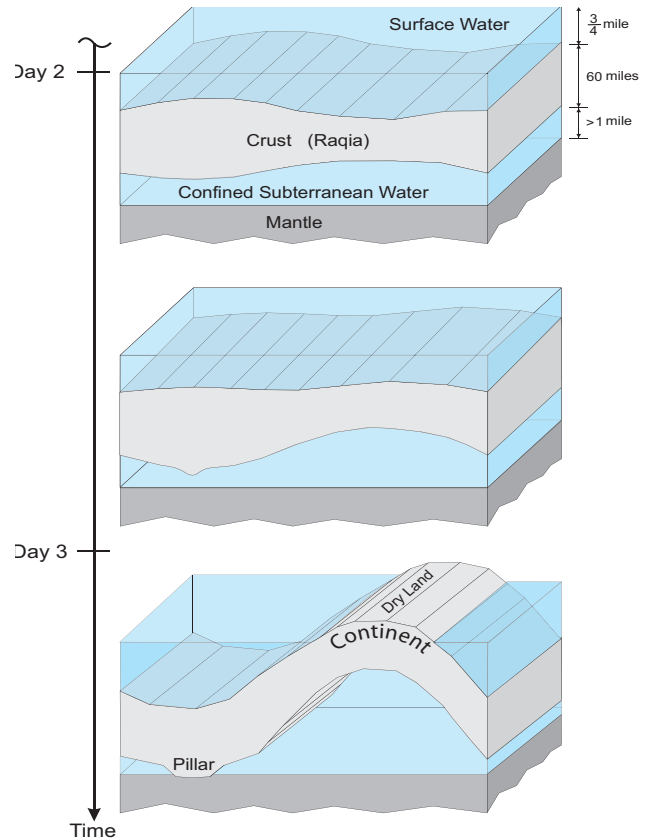

Figure 239: Dry Land Appears. At the end of the first creation day, *Day 1*, water covered the entire Earth. On *Day 2*, God made a “*raqia*” that sharply separated (“*badal*”) the liquid water (“*mayim*”) above from the liquid water below. On *Day 3*, land rose out of the surface water, in preparation for the creation of plants, animals, and humans. (Water thicknesses are exaggerated to illustrate events of *Days 2* and *3*. Dimensions are estimates.)

Sequence is important. If the Sun and Moon, created on *Day 4*, had existed before pillars formed, the Sun’s and Moon’s powerful gravity would have greatly deformed the temporarily unstable crust. Pillars—the foundations of the Earth—maintained stability.

Recognizing that a large amount of water was under the preflood crust, as the Bible states, is essential to understanding the flood. [See page 489.] Our failure to understand basic physical aspects of the flood led to the mistaken belief that evolution happened over billions of years.

To account for the water currently on Earth’s surface, the water in the subterranean chamber had to average about a mile in thickness. However, an unknown amount of additional water had to be in the subterranean chamber to account for the ice in comets, asteroids, TNOs, and some of the moons in the solar system. [For details, see page 594.]

exceed the subterranean water’s pressure pushing upward. If the pressure difference exceeded the rock’s shear strength at any point, rock would “flow” downward, deforming like putty. Compression tests on cylinders of rock subjected to high confining pressures, but larger axial loads, show that the rock cylinders deform like putty. [See “**Highly Compressed Solids,**” on page 608.]

Downward protrusions (pillars) would grow like the downward flow in a lava lamp, except the rock, a solid instead of a liquid, had internal strength due to atomic bonding. The deeper the sags, the greater this pressure difference would become, so rock would “flow” even deeper until all pillars pressed against the chamber floor. Pillars carrying an excessive load would thicken and penetrate slightly into the chamber floor, forming what we will call “sockets.”

If one squeezed a water balloon in a few places, it would bulge in other places. Likewise, as rock sagged *downward*, the fixed volume of subterranean water forced the thinner, less-dense parts of the crust *upward*, forming the *preflood mountains*.

Day 2. If, on *Day 2* of the creation week, our “sandwich” encircled the Earth like the outer three rings of an onion, water would cover the entire Earth. In the following hours, the thinner and less-dense portions of the crust would rise out of the surface water and become dry land. Water would drain into depressions. This seems to be what happened on *Day 3* (Genesis 1:9–10). Water covered the entire Earth, then “*God said, ‘Let the waters below the heavens be gathered into one place, and let the dry land appear’; and it was so. And God called the dry land earth, and the gathering of the waters He called seas;*” [Pages 518–526 further support this interpretation of *Day 2*.]

Genesis 1:9 says that the waters *below the heavens* were gathered into *one* place (i.e., one big ocean). Why, then, in the next verse did God call the collected waters “seas”—plural? **Answer:** Multiple seas were honeycombed *below* the crust—separated by pillars. *The Interpreter’s Bible* explains:

“*Seas*” embraces more than the waters upon the face of the earth; it includes also the (supposed) subterranean waters upon which the earth was believed to rest ... and the circumfluent ocean, upon which the pillars of the firmament stood.³

Psalm 24:2a specifically states that God “*founded it [the earth] upon the seas.*”

Interestingly, *Day 2* was the only creation day in which the Bible does not expressly say God saw that day’s work was “good.” Certainly, nothing bad was done on the second day, because at the end of the creation week, God saw that all He had made was “*very good.*” Apparently, the second day’s activity—the creation of the Earth’s crust (the *raqia*) with liquid water above and below, the lifting of continents, and the establishment of the Earth’s crust upon its foundation was not completed until *Day 3*.

Now we can see why. On *Day 2*, immediately after the crust was created with liquid water above and below it, the crust had to deform. Heavier portions sagged and squeezed down pillars, while lighter portions rose out of the water. On *Day 3* (after establishing the pillar structure—the foundations of the Earth), God stated in Genesis 1:10 that “it was good.” Later on *Day 3*, after vegetation was created, God made a similar statement. Thus, *Day 3* was the only creation

day in which two “it was good” pronouncements were made.

Psalm 104:3, in describing *Day 2*,⁴ states (with my interpretations in brackets), “*He lays the beams [pillars] of His upper chambers [the crust] in the [subterranean] waters.*” By *Day 3*, surface water had drained into depressions, exposing dry land—a “good” condition (Genesis 1:10) necessary for what God would create next: life.

Peter also seems to describe these events. He states that in the latter days mockers will not understand that,

The earth was formed out of water and by water, through which the world at that time was destroyed, being flooded with water. (II Peter 3:5–6)

This is consistent with the following interpretation: On *Day 2*, a nearly horizontal crust, or “expanse,” was formed in the midst of the liquid water covering the Earth (Genesis 1:2,6,7,9). On *Day 3*, lighter portions of the crust rose out of the water, causing water above the rising crust to flow into depressions (Genesis 1:10). In other words, the Earth (its crust) was formed **out of** (rose out of) surface water and was formed **by** pressure from subterranean water. Some might incorrectly think “forming the Earth out of water” implies alchemy; that is, water (H₂O) was changed into SiO₂, (Mg,Fe)₂SiO₄, and a host of other minerals that comprise rock. (Even if alchemy occurred, one would not say rock formed **by** water; one would say rock formed **from** water.) Actually, “out of” is used in a spatial sense. The King James Version clearly conveys this idea of the land rising out of water: “... *the earth standing out of the water ...*” The *Complete Jewish Bible* states, “*long ago there were heavens, and there was land which arose out of the water and existed between the waters.*” II Peter 3:5b [emphasis added]

An ancient writing, ascribed to Rabbi Eliezer ben Hyrcanus (A.D. 80–118), vividly described these events as follows:

Until the third day of creation, the earth was level as a plain and water covered the whole earth. When God said [Genesis 1:9], ‘Let the waters below the heavens be gathered,’ the mountains and hills arose and other parts became depressions. The waters filled these depressions and they were called seas.

With remarkable insight a few lines later, he states that “*the earth is spread upon the water just like a ship which floats in the midst of the sea.*”⁵

After about 2,000 years,⁶ the water below the crust burst forth as “*the fountains of the great deep,*” combined with surface water, and, as Peter wrote, flooded and destroyed the Earth in a global cataclysm. The Greek word *kataklyzo*, from which we get our word “cataclysm,” is translated as “flooded” in II Peter 3:6. In describing Noah’s flood, the Bible never uses the normal Greek or Hebrew words for flood. Noah’s flood was much more; it was an unparalleled, global cataclysm—Earth’s defining geological event.

The Hebrew word *raqia* is usually translated as “expanse” or “firmament.” Pages 518–526 explain why *raqia* is sometimes

identified with “heavens” but in other contexts refers to Earth’s pre-flood crust. [See [“Was There Fire in Waters?”](#)]

Pressure from the compressed subterranean water supported most of the crust’s weight; pillars supported the rest. Every 12 hours, tidal effects, caused primarily by the Moon’s gravity, lifted the subsurface water (and, therefore, earth’s crust), just as tides lift ocean surfaces today. At low tides, the crust settled. Each pillar’s pressure on the chamber floor increased and decreased twice daily. These loose, flexible, contacts could be described as **“sockets”**—indentations in the chamber’s floor.

The Bible says the earth was founded on pillars. Psalm 75:3b says, *“It is I [God] Who have firmly set its [the earth’s] pillars.”* In Job 38, God demonstrates His authority by giving Job the most difficult science examination of all time. In verses 4–6, God asks Job, *“Where were you when I laid the foundation of the earth? Tell Me, if you have understanding, ... On what were its bases sunk?”* This word, “bases,” is translated in all 54 other places in the Bible as “pedestals” or **“sockets” which held pillars.**

Two verses later, in Job 38:8–11, God says that he caused a confined sea of water, enclosed in a dark cloud, to burst forth—apparently describing the fountains of the great deep.

Or who enclosed the sea with doors, when, bursting forth, it went out from the womb, when I made a cloud its garment, and thick darkness its swaddling band, and I placed boundaries on it, and set a bolt and doors, and I said, “Thus far you shall come, but no farther; and here shall your proud waves stop.”

This was one of earth’s most dramatic physical events ever.

Recorded Ancient History. Ancient extrabiblical writings, although not having the authority of biblical passages, also describe this pillar structure within the subterranean water. As one example, the British Museum’s *The Book of the Cave of Treasures* (dated at about A.D. 300–599) states:

*And on the Third Day God commanded the waters that were below the firmament to be gathered together in one place, and the dry land to appear. And when the covering of water had been rolled up from the face of the earth, the earth showed itself to be in an **unsettled and unstable state**, that is to say, it was of a damp or moist and **yielding nature**. And the waters were gathered together into seas that were under the earth and within it, and upon it. And God made the earth from below, corridors and shafts, and channels for the passage of the waters; ... Now, as for the earth, **the lower part of it is like unto a thick sponge, for it resteth on the waters.**⁷ [emphasis added]*

The Bible often speaks of *“the foundation(s) of the earth.”* On Day 3, the earth’s crust was literally established, or set (using pillars), on its foundation. Had this not happened, the crust would have continually tottered (or undulated,

Was There Fire in Waters?

So much heat was generated within the pillars that they would have glowed, as incandescent filaments in lamps do today. Even some burning may have occurred in the subterranean water. [See **“Energy in the Subterranean Water”** on page 597, especially Figure 267.] With hot, glowing pillars (part of the *raqia*), the sight within the otherwise pitch-black subterranean chamber would have been eerie. An apt description of this might be “fire in waters.”

One of the most famous and revered Hebrew scholars of all time, Rabbi Solomon Yitzchaki (A.D. 1040–1105) of France, proposed that the correct translation for Genesis 1:8a is *“And God called the expanse fire in waters,”* instead of the normal *“And God called the expanse heaven.”* The reason may surprise you.

Before A.D. 700, written Hebrew contained only consonants. Vowel points were then inserted to standardize pronunciations. For example, the meaning of

n th bgng Gd crtd th hvns nd th rth

may be clear, but the phrase is difficult to pronounce (and, therefore, to remember). If other vowels had been inserted in “hvns,” the word would have a different meaning today. Rabbi Yitzchaki, in his eleventh century *Rashi Commentary*, pointed out that with different vowel points the original Hebrew word we now think of as meaning “heaven” in *Genesis 1:8a* would mean “fire in waters.”

While in Jerusalem on 28 June 1990, I met for two hours with Michael Klein, Dean of Hebrew Union College. My question was, “What did *raqia* (expanse) and *shamayim* (heaven) mean in Genesis 1:8a when Moses wrote Genesis?” To my surprise, he suggested Rabbi Yitzchaki’s translation, which I had previously studied. *Shamayim* is a compound of the words fire (*esh*) and liquid water (*mayim*). After I briefly outlined the hydroplate theory, Dean Kline said that *raqia* (as opposed to *“raqia of the heavens”*) might well have been the earth’s crust—also symbolically called “fire in waters.” You decide.

like the surface of an earth-size waterbed). Perhaps this is why the psalmist wrote, *“He established the earth upon its foundations, so that it will not totter forever and ever.”* (Psalm 104:5) Only by understanding some basic physics and the role of subterranean water, will these matters—and the global flood—be clear.

Tidal Pumping. Each tidal cycle in the subterranean chamber (driven by the Sun’s and Moon’s gravity) stretched and compressed the pillars.⁸ This cyclic compression—tidal pumping—twice a day for about 2,000 years, constantly heated the pillars and subterranean water. The pressure

increased in the chamber—but not to the “breaking point” as we will see in Genesis 2:6, and if we take seriously Genesis 1:31: “*And God saw all that He had made, and behold it was very good.*” A ticking time bomb under everyone’s feet would not have been good, let alone “*very good.*”

As temperatures rose throughout the chamber from tidal pumping, the water became supercritical, so the more soluble minerals, such as quartz, dissolved certain minerals within the granite ceiling, such as quartz. Thus, the lower crust became porous. [See pages 126–127 and pages 595–596.]

Hot water was then rapidly and easily transferred up through the spongelike (porous) lower crust by natural convection, a rapid process. (Heat transferred by *conduction* through the solid rock crust is extremely slow.) While the circulating hot water was sealed under the upper crust, the heat was not. Consequently, the soil-water zone, just below the earth’s solid surface was heated from below. Therefore, steam exited into the atmosphere at millions of locations throughout the earth, primarily through the elevated, thinner, and less dense continents. [See Figure 239 on page 469.] That steam is described in Genesis 2:6: “*But a mist used to rise from the earth and water the whole surface of the ground.*” Each night, the atmosphere’s warm water vapor (steam) radiated its heat into outer space and condense as heavy dew, abundantly watering the ground over the entire earth. That condensed water then recharged the hydrosphere. This cycle was ongoing, driven by heat from tidal pumping in the subterranean chamber.

That steady state condition was reached without pressures or temperatures that would cause the crust to fail. *Therefore, it was either man’s sinful actions (or inactions) or a direct act by God that later caused the crust or pillars to fail.*⁹ Yes, these are only possibilities, but they bring us to the same starting point as the strictly scientific hydroplate theory. Regardless of how one reaches that point, everything that follows is within the scientific realm. Heat could then be rapidly and easily transferred up through the spongelike (porous) lower crust by water convection.

Heat is required to produce water vapor that can then become a mist. For a mist to “water the whole surface of the ground” and provide water for all animal and plant life, the heat must be generated globally, uniformly, and at regular, closely-spaced time intervals. What was that heat source?

It has been shown that it would have taken 10 years for tidal pumping in the subterranean water to make the liquid water in the subterranean chamber supercritical *if that liquid water was initially as cold as ice water (32 degrees Fahrenheit).* [See “**Tidal Pumping: Two Types**” on page 595.] In that case, it would have taken at least 10 years for the earth’s crust to become porous enough for heat from tidal pumping to begin producing the mist that daily watered the earth. Preflood rivers and vegetation would not have had a water source for at least 10 years. Life on earth

would have become extinct. Because that did not happen, we can reasonably conclude that the initial temperature of the subterranean water was much warmer than ice water.²

Figure 240 on page 476 explains why the subterranean water was supercritical after the second day of creation.

The Rupture. On one day, the crust ruptured and the flood began.

On the same day all the fountains of the great deep burst open. (Genesis 7:11)

Some water from the jetting fountains fell as rain. Subterranean water flowed with unimaginable force horizontally through the subterranean chambers and up through the globe-encircling rupture. As subterranean water was escaping upward, the pillars had to support more of the crust’s weight, because the subterranean water supported less. Each pillar’s collapse increased the load on the remaining pillars, so more pillars collapsed, much like a falling house of cards. Each collapse produced huge waves in the surface water and pressure pulses in the subterranean water. Rock fragments from the crushed pillars were swept up by the escaping waters and accelerated into space by the powerful fountains of the great deep. Some rocks merged to become comets and asteroids.¹⁰ Those that did not merge became meteoroids. Thus, the pillars, or foundations of the world, collapsed. This may be what Psalm 18:15 refers to when it says, “*Then the channels of water appeared, and the foundations of the world were laid bare.*”

How hot might the high-pressure water have become? Question 5 on page 341 explains why some meteorites reached temperatures of at least 1,300°F. Some minerals in other meteorites were even hotter,¹¹ a fact that perplexes meteorite experts, because meteorites came from supercold outer space, where temperatures are almost absolute zero (-460°F). This heating was not due to impacts or atmospheric friction because the heating occurred not just on meteorite surfaces, but *throughout* meteorites. Iron meteorites came from crushed pillars, as explained on pages 337–374, so pillars and the subterranean water exceeded 1,300°F.

Sinking Continents. Since lighter (and higher) portions of the crust were supported entirely by subterranean water, primarily the continents and preflood mountains sank as the subterranean water escaped during the flood phase. Therefore, *the flooded earth resulted as much from sinking continents as from rising water.*

Genesis 7:20 says that the floodwaters covered all preflood mountains by 15 cubits (about 22½ feet). Today, mountain heights vary by thousands of feet, so why did many, if not all, preflood mountains have similar elevations? (Some commentators say that “at least” 15 cubits of water were above *all* the earth’s mountains. Others say that the text means the Ark, whose height was 30 cubits, must have been only half submerged and did not run into mountain peaks.) The explanation becomes clear if we recognize that:

(a) today's mountains were formed by completely different mechanisms than those on the preflood earth, and (b) the preflood earth's crust was founded on and spread out above liquid water (Psalms 24:2, 104:3, and 136:6). Here's why the floodwaters covered the preflood mountains by 15 cubits:

On *Day 3* of the creation week, the higher a continent rose out of the surface water, the more pressure it exerted on the subterranean water directly below. To demonstrate this buoyancy effect, support a large rock under water with one hand. Notice how the pressure on your hand increases as you slowly lift the rock out of the water. Therefore, as the land rose higher, it would have risen more slowly, giving preflood mountains similar heights.

About 2,000 years later, as the floodwaters rose and continents sank, this same buoyancy effect caused preflood mountains not yet covered by water to exert greater pressure on the water still under the crust. This reduced their height and lifted lower mountains, nearly equalizing mountain heights above the rising water—just as Genesis 7:20 states.

As the flood progressed, pillars were increasingly crushed, so more and more of the crust rested on the subterranean chamber floor, slowing the water's escape. The vertical walls on each side of the rupture were about 60 miles high. Because the rock's pressure in the bottom half of each wall exceeded its crushing strength, the unsupported, unconfined walls continually crumbled—for 150 days (Genesis 7:24). During that time, the high-velocity fountains of the great deep removed that rubble, widening the rupture hundreds of miles.

Mass deep in the mantle shifted slowly toward these relatively unloaded portions of the chamber floor. Suddenly, the chamber floor buckled upward beneath the widened rupture, first forming the Mid-Atlantic portion of the Mid-Oceanic Ridge. The crust slid downhill on lubricating water, away from the rising Mid-Atlantic Ridge. Sliding continental plates—hydroplates—eventually crashed and compressed during the “*compression event*.”

Weaker portions of the hydroplates crushed, thickened, and buckled—all within one hour. [See “[Could Earth's Mountain Ranges Form in Less Than an Hour?](#)” on page 486.] In doing so, the new, postflood continents rose out of the floodwaters, allowing water to drain into newly opened—and temporarily very deep—ocean basins. Buckled mountains also formed, as shown in Figure 50 on page 117. For each cubic mile of land that rose out of the floodwaters, one cubic mile of floodwater could drain. (Note: Today, the volume of all land above sea level is only

one-tenth of the volume of all water on earth.) Other dramatic consequences in the Pacific, including formation of huge ocean trenches, are discussed on pages 153–192.

Sliding rock-on-rock contacts quickly became molten rock-water mixtures. This is why magma contains a surprising amount of dissolved water. Some of the subterranean chamber's water appears to remain: a thin saltwater layer under portions of all continents at the depth predicted by the hydroplate theory,¹² and a thick, water-laden layer under the Tibetan Plateau.¹³

Conclusions. The creation was “very good.” Sometime after the Fall but before the flood, a chain of physical events began that produced a global flood. The earth then was filled with violence (Genesis 6:11), so humans may have been directly responsible, although we cannot be sure exactly how it began. Nevertheless, that cataclysm had many consequences: layered fossils; coal, oil, and methane deposits; major mountain ranges; the Ice Age; and dozens of other global features. Our challenge is to explain their details in the simplest, most internally consistent way that adheres to the laws of physics. (If that explanation happens to conform to the biblical account, that is no reason to reject it.)

The events of the flood become clear and dozens of scientific problems that befuddle evolutionists are solved when one understands the events of the second creation day and that a large volume of water was trapped under earth's early crust.

For centuries, hundreds of sincere questions about the flood have been asked; they deserve thoughtful, accurate answers. Without clear explanations, a “vacuum” has existed into which evolutionists have placed faulty theories. If we simply tell others (especially nonbelievers) to believe the Bible, we create unnecessary resentment because the questions remain, faulty explanations continue to be universally taught, and we may appear self-righteous.

Day 2—a key to explaining the flood—has been poorly understood. As Peter wrote, people would not understand that earth's crust was formed out of water and by water that later flooded the earth. This proposed interpretation of *Day 2* helps us appreciate the presence of so much subterranean water, the power of “*the fountains of the great deep*,” why they all erupted so quickly (on one day), and where the floodwaters came from and where they went. Had the flood been better understood before Charles Darwin popularized evolution, many more people would have recognized that evolutionary explanations are ridiculous. Evolution would not have flourished. Our task, then, is to explain to others what we now know about the flood.

References and Notes

1. Was the flood inevitable—“programmed” from the beginning? No. If sin had not entered the world, I believe that the earth would still have its preflood subterranean water and pillars.

If mankind had not sinned, the abundant geothermal energy generated by tidal pumping [explained on page 595] could have been used for people's benefit, not their destruction.

After all, humans needed an energy source to lift, transport, heat, and illuminate—to fully exercise dominion over the earth (Genesis 1:28). Today’s primary energy sources, fossil fuels and nuclear reactors, did not exist before the flood, but are recognized global pollutants.

2. The rock layer—the earth’s crust—would have had some stiffness, because it was about 60-miles thick. However, the crust’s large area would have given it great flexibility. If the crust’s thickness, density, or strength varied horizontally (as a sine wave, for example) with a wavelength of 110 miles, the crust would have sagged downward to the chamber floor at more than 18,000 locations.

The effects of the rock sagging downward through water at one location on earth would spread laterally, but only at the speed of sound in water. Outside that expanding “ring of influence,” other sags could occur simultaneously.

The sagging crust, on DAYS 1 and 2 of the creation week, lost potential energy. Where did that energy go? Most of it heated the subterranean water to an unknown *but significant* extent.

3. Walter Russell Bowie, “The Book of Genesis,” *The Interpreter’s Bible*, Vol. 1 (New York: Abingdon Press, 1952), p. 473.
4. See Endnote 9 on page 492.
5. See also Pirkê De Rabbi Eliezer, translation by Gerald Friedlander (New York: The Bloch Publishing Company, 1916), pp. 27–28.

The original Hebrew can be found in chapter 5 at www.daat.ac.il/daat/vl/pirkeyeliezer/pirkeyeliezer02.pdf.

6. According to the Masoretic text of the Old Testament, this time period was 1,656 years. [See page 504.] According to the Septuagint (Greek) text, it was 2,242 years. According to the Samaritan text, it was 1307 years. [See Table 33 on page 512.]
7. *The Book of the Cave of Treasures*, translated from the Syriac Text of the British Museum (MS. Add. 25875) by Sir E. A. Wallis Budge (London: The Religious Tract Society, 1927).
8. Before the flood, the energy added to the pillars every 12 hours by the gravitational pull of the Moon, and to a lesser extent the Sun, was huge. That energy was proportional to the crust’s massive weight times the average lift distance. [For details see “Tidal Pumping: Two Types” on pages 595–596.]
9. Sin has physical consequences (Genesis 3). What might they be when every intent of all humans (except Noah) was evil continually (Genesis 6:5, 7:1)? Could mankind’s activities have caused physical changes that further weakened the crust or a few pillars? After all, “*the earth [at that time] was filled with violence.*” (Genesis 6:11) A sufficiently large man-made explosion (or many other possibilities which we, thousands of years later, cannot even imagine) might have disrupted the weakened crust and pillar system, and initiated the rupture—which then triggered the flood.

For some, a second possibility is that God could have commanded the earth’s crust to crack or a pillar to collapse. God spoke the universe into existence, so commanding such a small thing at the right place, which is all it would take, is not difficult to imagine.

But, would this second possibility depart from science by injecting a miracle into the physical world? The hydroplate theory does not assume that a miracle happened. (The theory has only three starting assumptions, as listed on page 124. Starting assumptions, often unstated, are part of every scientific theory that tries to explain the past.) A third response is, “We don’t know.”

Creation science tries to explain what we see in the universe with the fewest assumptions and without appeals to miracles not specifically mentioned in the Bible. (Invoking miracles to solve scientific problems irritated many scientists and led to a rigid insistence on uniformitarianism.) Creation science avoids the narrow-minded assumption that “the physical universe is all there is and all there ever will be.” Such a perspective (materialism, scientism, and uniformitarianism) produces scientific contradictions. Creation science, on the other hand, does not invoke self-serving miracles, is more consistent with the evidence and the laws of physics, and recognizes the obvious: there is a Creator (Romans 1:20). [See “How Can the Study of Creation Be Scientific?” on page 438.]

10. For details and supporting evidence, see pages 301–374.
11. Besides iron meteorites, which were once at least 1,300°F, chondrules were once about 3,000°F. [See Figure 185 on page 341 and “Chondrules” on page 410.] Also, the matrix material encasing chondrules shows thermal metamorphism requiring temperatures of at least 750°F. [See O. Richard Norton, *The Cambridge Encyclopedia of Meteorites* (Cambridge, England: Cambridge University Press, 2002), p. 92.] While the heat-generating mechanisms for each are different, all three result from the release of gravitational potential energy.
12. “*Magnetotelluric measurements show the lower continental crust to be electrically conductive globally ... The most probable candidates for the conduction mechanisms are small amounts of interconnected saline pore fluids and interconnected thin films of graphite. ... We favor the supercritical saline fluid model ...*” R. D. Hyndman et al., “The Origin of Electrically Conductive Lower Continental Crust: Saline Water or Graphite?” *Physics of the Earth and Planetary Interiors*, Vol. 81, 1993, pp. 325, 341.

While these authors favor the *supercritical* saltwater explanation for this electrical conductivity, they assume that the saltwater is in innumerable microscopic pockets that are electrically and horizontally connected. The authors are puzzled, because so much horizontal connectivity should be accompanied by vertical connectivity. Over long geological ages, this water should have leaked up to the earth’s surface.

The hydroplate theory solves the problem. The preflood subterranean water layer had worldwide (horizontal) connectivity only. Within a century, tidal pumping made that water supercritical, so it began dissolving certain minerals, such as quartz and salt, and expanded vertically into the growing spongelike pockets in subterranean chamber’s floor and ceiling. As water escaped during the flood, the subterranean layer simply became thinner.

- ◆ “*Nevertheless, the simplest explanation of increased conductivity in the deep crust is the presence of a continuous,*

lithostatically pressured, water-rich fluid.” Bruce W. D. Yardley and John W. Valley, “How Wet Is the Earth’s Crust?” *Nature*, Vol. 371, 15 September 1994, p. 206.

After presenting a strong case for the presence of water trapped deep under the earth’s surface, Yardley and Valley point out a problem. Over hundreds of millions of years, that water would leak up to the earth’s surface. It apparently never occurred to these authors that the earth is not hundreds of millions of years old, and most of the subterranean water did escape upward—during the global flood.

13. See the quote by Wenbo Wei et al. in Endnote 83 on page 148.

Note: The hydroplate theory makes 58 explicit predictions. Prediction 1, published in 1980, says that large volumes of pooled saltwater are beneath major mountains. The above study by Wei et al. explains why saltwater appears to be about 10 miles below the Tibetan Plateau (the world’s highest and largest plateau), which is bounded on the south by the most massive mountain range on earth.

Did It Rain before the Flood? What Generated the Preflood Mist?

Genesis 2:5–6 suggests that it did not rain before the flood:

*Now no shrub of the field was yet in the earth, and no plant of the field had yet sprouted, for the Lord God had not sent rain upon the earth; and there was no man to cultivate the ground. But a mist used to rise from the earth and water the whole surface of the ground.*¹ [emphasis added]

Notice, these verses only say that *after creation, it had not rained*. How long did this condition last? Some believe that this mist began the evaporation-rain cycle. If so, the period of no rain was brief, and there was rain before the flood. But if the “no-rain condition” ended sometime before the flood, wouldn’t that have been mentioned? Let’s look for other clues.

Rainbows. God promised never again to flood the entire earth (Genesis 9:12–17), a promise marked by a “*bow in the cloud*”—a rainbow. Rainbows form when raindrops refract sunlight. This suggests that rainbows began after the flood, which would mean there was no preflood rain.

Others disagree, saying rainbows may have been visible before the flood, but afterward God simply associated His promise with rainbows. This would be similar to the symbolism of a wedding ring. Rings existed before a wedding, but afterward the ring recalls a solemn vow. However, if rainbows suddenly began right after the flood, the rainbow’s symbolic effect would have been more unforgettable and reassuring to the frightened survivors of the flood.

Some argue that rainbows would have formed before the flood every time water splashed and droplets refracted sunlight. This argument overlooks that God’s promise concerned rainbows “*in the cloud*,” not a relatively few drops of water several feet above the ground for a few seconds.

A Terrarium. The Hebrew word translated “mist,” (טל), in Genesis 2:6 is used in only one other place in the Bible—Job 36:27. There, it clearly means water vapor. So, did the preflood Earth act as a humid terrarium in which water vapor evaporated, condensed as dew without rain-fall, and watered the Earth? Could an Earth-size terrarium produce enough water to supply major rivers,

such as described in Genesis 2:10–14? (Two preflood rivers, the Tigris and Euphrates, were evidently similar to and the basis for naming the mighty postflood rivers that today bear the same names. See Endnote 5 on page 535.)

Differences between the Preflood and Postflood Earth. If the hydroplate theory is reasonably correct, at least half of Earth’s water was under the preflood crust, so Earth’s *preflood surface* had less water than today. There were large seas, but no oceans the size of the Atlantic or Pacific. Also, tidal pumping continuously produced vast amounts of heat in the subterranean water chamber, about 60-miles below Earth’s surface. [See “**Tidal Pumping: Two Types**” on pages 595–596.]

As explained in Figure 240, by the end of the third creation day, the subterranean water was extremely hot (actually, supercritical). The lower crust was made porous by the ability of supercritical water (SCW) to dissolve certain minerals in the lower crust, such as quartz, which created sponge-like pockets. Those openings then filled with SCW and warmed Earth’s surface. (Water from the subterranean chamber did not rise high enough to mix with Earth’s surface water.) Eventually, the heat lost by the SCW in evaporating ground water equaled the heat added to SCW by tidal pumping in the chamber. At that point, temperatures and pressures in the chamber no longer increased—a condition known as *steady state*. The evaporated ground water, **was the mist of Genesis 2:6 that rose “from the earth and watered the whole surface of the ground,”** as heavy dew. Thus, vast amounts of heat were radiated into outer space, primarily each night, as heavy dew watered the ground.

If enough heat enters a drop of liquid water, the water becomes steam (water vapor). When heat is removed from water vapor, liquid water returns (condenses) as rain or dew. The heavy dew that settled and watered the preflood Earth each night returned liquid water to the Earth’s surface completing the water cycle. Today, water evaporation is driven almost entirely by heat from *above* Earth’s surface—heat from the Sun. Before the flood, water evaporation was also driven by heat from *below* the Earth’s surface—heat produced by

Figure 240: Foundations of the Earth. On Day 2 of the creation week, the *raqia* (a Hebrew word sometimes translated “expanse” or “firmament”) was placed in the midst of the waters that covered the Earth. As explained on page 523, *raqia* means a pressed-out or pressing-out solid. The *raqia* had about a 1-mile thick layer of liquid water (mayim) above it and at least as much below it. No doubt the *raqia* varied in thickness and density along its length,³ so it would have sagged slightly in many places, as if forces (F_1 , F_2 , etc.) pressed on a uniform, but flexible slab of granite. Surface water would have flowed into those depressions, causing them to sag even more. That, in turn, allowed still more surface water to flow into the depressions, further deepening them. Eventually, portions of the crust, heated to some extent by the deformation, pressed against the chamber floor, establishing the firm “foundations of the Earth,” mentioned in seven places in the Bible.⁴

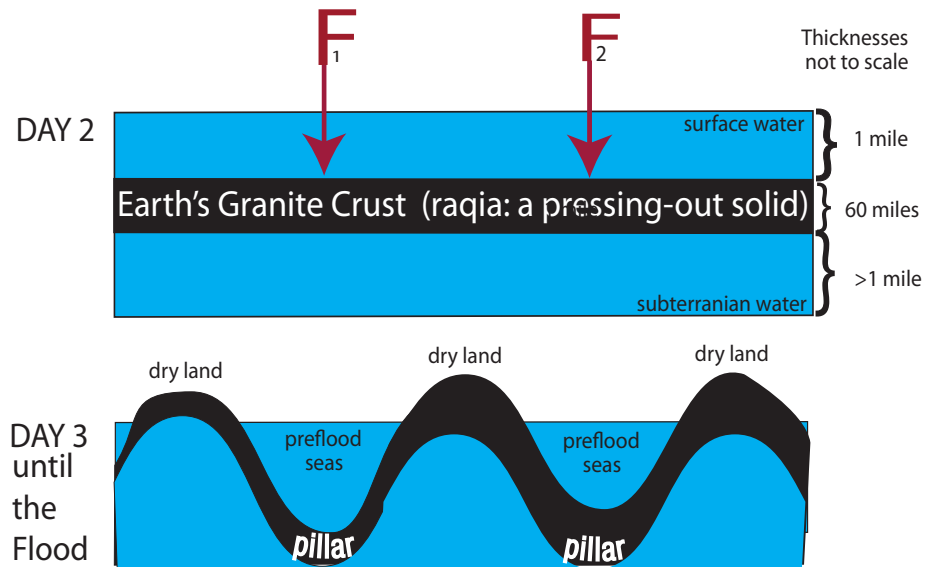

Although the crust was about 60-miles thick, it was 200,000,000 square miles in area, encircled the globe, and was underlain with water. Therefore, before the Earth's foundations were established, the crust had great vertical flexibility. The points of contact between the sagging crust and the chamber floor will be called “pillars,” but notice they are not shaped like pillars we see in buildings today. They were “the beams of His Upper chambers that God laid in the waters.” (Psalms 104:3)

Because confined water was below the *raqia*, those downward forces also lifted dry land out of the water that covered the entire Earth on the first day of the creation week. Confirming this is Genesis 1:9–10 (saying in the King James translation, “the earth standing out of the water;”), and II Peter 3:5b. About 2,000 years later, the subterranean water burst out and flooded the Earth—not only as heavy rain falling from the fountains of the great deep, but by the granite crust subsiding and forcing subterranean water up onto the Earth's surface for weeks after the rain had stopped.

God gave Job a difficult examination which included a question most of us would not have been able to understand or visualize—let alone answer.

“Where were you when I laid the foundation of the earth? (Job 38:4)”

Had the foundations of the Earth not been established, Earth's crust, resting entirely on subterranean water and subject to twice-daily subterranean tides, would have continually undulated. People and animals would have felt as if they were living on a giant, but stiff, “water bed.” As stated in Psalm 104:5,

He established the earth on its foundations, so that it will not totter forever and ever.

Powerful Heating of the Subterranean Water. A fixed volume of subterranean water was confined below the crust, so as the denser crust subsided, an equal volume of less dense crust had to rise by an identical amount. (Energy lost inside one part of an isolated system is always gained in another part of that system.) That loss of the crust's potential energy—dense crust falling while light crust was rising—added energy in the form of heat to the subterranean water. Surface water then flowed into and deepened each depression, forming the many preflood seas. If at least one percent of the surface of the preflood Earth was dry land, **the added heat would have made the subterranean water supercritical by the end of Day 3.**⁵ [See pages 126–127 and Figure 75 on page 145.] Evaporation by that heat, plus the continual generation of heat by tidal pumping (as explained on page 595), is another example of the pressing action by the solid *raqia*. This system (without rain, storms or lightning) watered the preflood earth gently and uniformly, each night with pure liquid water (heavy dew).

tidal pumping in the subterranean water chamber. [See “What Triggered the Flood” on pages 469–475.]

A subtle message in Genesis 2:5–6 is that the watering of the Earth by a mist was a steady, routine occurrence. Therefore, the heating that produced that mist also had to be steady. Since steady state had been reached, heat and pressure were not building up indefinitely in the subterranean chamber. Had steady state not been reached, the subterranean water chamber with its tidal pumping, would have been a ticking time bomb. On the contrary, everything that God created was “very good” (Genesis 1:31). Creation did not include a ticking time bomb, nor any comets or asteroids aimed at Earth. Another important difference, already explained by the hydroplate theory, was Earth's smoother preflood topography, because Earth's major mountain ranges were buckled up at the end of the flood. [See pages 111–151.] Because it was smoother than today, rivers

flowed more slowly, never flooded, and required less water condensation to keep them filled. Preflood mountains existed, but no major mountains such as the Rockies, Andes, or Himalayas. There were no volcanoes, glaciers, or polar ice caps before the flood. [See Endnote 35 on page 185.] The preflood Earth had greater land area, because so much water was below the crust, and Earth's radius was slightly larger.⁶ Without major barriers—oceans, mountain chains, and glaciers—travel was easier. With so much water condensation, preflood forests were abundant and lush, enough to form today's vast coal, oil, and methane deposits. This left little room for deserts. With 360-day years, days were slightly longer. *As you will see, these preflood conditions prevented rain, but abundantly watered a thirsty Earth.*

Wind. Most wind is produced by atmospheric temperature differences; wind then mixes air with different temperatures and moisture contents. The various “mixtures” give us

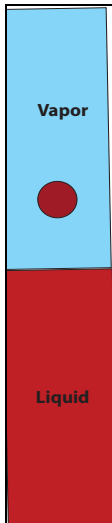

Figure 241: Supercritical Fluids. Because supercritical fluids (first explained on page 126) are critical in understanding the lush conditions on the pre flood Earth and the power of the fountains of the great deep, here is another, more intuitive, description of supercritical fluids.

The container on the left contains a hot liquid and vapor of a fluid. The fluid could be water, (liquid water in the bottom and water vapor, steam) in the top. Instead of water, it could be a liquid and vapor of another pure substance, such as carbon dioxide, nitrogen, or even a substance that is usually a solid but is so hot it is a liquid. The pressure inside this container is so great that *the highly compressed vapor has the same density as the liquid, which, by definition, makes it **supercritical***. What would happen if a little gremlin lifted a drop of the liquid and placed it in the vapor? That drop would float, because the densities of the liquid and vapor are equal.

Because temperatures are uniform within the container, for every liquid molecule that evaporates from a floating droplet, one vapor molecule, on average, will collide with and condense on the droplet. Vapor molecules that slam into the liquid in the bottom of the container act as our imaginary gremlin, because they splash liquid droplets up into the vapor, scattering all the liquid in the bottom of the container as microscopic droplets floating throughout the vapor. Therefore, Supercritical fluids have millions of microscopic liquid droplets floating in the vapor.

By the end of Day 3 of the creation week, (as explained in Figure 240), the water in the subterranean chamber (an extremely high-pressure container) was supercritical—able to dissolve certain minerals in the chamber’s ceiling, such as quartz, making the lower crust as porous as a thick sponge.” [See “**Recorded Ancient History**” on page 471.] Every drop of supercritical water in that subsurface ocean was also highly explosive, able to expand a thousand fold with unimaginable violence, as an upward jet, if the crust ruptured, allowing the pressure in the chamber to drop.

weather: rain, snow, hail, hurricanes, tornadoes, droughts, fair weather, etc. Without today’s vast oceans,⁷ volcanoes, major mountains, and ice sheets, the pre flood Earth had more uniform temperatures. Also, the abundant pre flood vegetation moderated temperatures by evaporative cooling during the day and condensation (which always releases heat) at night. More uniform temperatures meant less wind⁸ and fewer weather extremes.

Condensation Nuclei. Water droplets almost always begin with water vapor condensing on a *solid surface*. A common example is early-morning dew that collects on grass. Raindrops, snowflakes, and fog particles begin growing on microscopic airborne particles (even bacteria⁹). These particles, called **condensation nuclei**, are typically 0.001–0.0001 millimeters in diameter—less than one hundredth the diameter of a human hair. Each cubic inch of air we breathe contains at least 1,000 such particles. Molecules of water vapor rarely collide and stick together; instead, a water droplet forms when trillions of water molecules collect on one of these microscopic particles.

If all sizes were scaled up, so a water molecule was the size of a ping-pong ball, a condensation nucleus would be a house-size “rock” and a raindrop would be 100 miles in diameter. When a gaseous water molecule strikes that “rock,” much of the molecule’s energy is transferred to the “rock” as heat. Because pre flood humidity was high with all the mist rising each day from the Earth’s surface, the molecules would stick when the temperatures dropped below the “dew point” at night; condensation would begin. The “rock,” slightly warmer because of the added energy from colliding water molecules, warmed the surrounding air, causing slight updrafts. Moist breezes plus updrafts brought enough moisture to “the rock” for it to grow quickly into a water droplet.

That “rock” and its growing water volume could not “float” in calm air for long, just as a grain of sand cannot float in still water. However, *flowing* water and air can suspend both. With more uniform temperatures globally and less pre flood wind, condensation nuclei received less

lift and stayed closer to the ground. There would have been no lightning, which requires trillions of very high, convecting water droplets. (Besides, lightning would have sometimes killed people, contradicting Genesis 1:31.) Clouds may not have existed.

A microscopic droplet growing in the air has a tiny volume, but a relatively large cross-sectional area. Therefore, rising, moist air carried the tiny droplet upward and added liquid water to it. As it grew, its weight increased faster than its cross-sectional area, so it quickly settled to the Earth, collecting other droplets in its path. We could describe this as mist rising from the Earth and then settling back to water the ground. (Sounds like Genesis 2:6, doesn’t it?)

It would be similar to morning fog rising on a still lake, but with several differences. First, before the flood, the earth had no polar ice and no snow-capped mountains, so less solar radiation was reflected back into space, and more of the Sun’s rays heated earth during the day. With more forests, few (if any) clouds, and slightly longer days, the sun evaporated more water than today—and the mist rising from the pre flood earth kept relative humidity high. At night, with fewer clouds and longer nights, more heat escaped into space, so more water condensed. (Today, clouds reflect 20–25% of earth’s incoming radiation back into space and hold in much of the outgoing radiation.) Therefore, ***the pre flood earth was watered much more abundantly and uniformly by daily condensation than by rainfall today***. Unlike today, there were no long dry or wet spells, droughts, or local floods.

Heavy condensation before each sunrise kept moisture closer to the ground, further restricting cloud formation. Today, morning fog evaporates soon after sunrise, before the moisture can settle to the ground. With fewer, if any, high clouds before the flood, temperatures dropped more rapidly at night. This, coupled with more moisture in the daytime air, allowed water droplets to grow larger, settle to the ground faster, water plants abundantly, and soak into the soil before morning evaporation could begin.

Preflood Rivers

The preceding description of preflood meteorology helps us understand what would otherwise be the four strangest rivers the earth ever had. Genesis 2:10–14 states:

Now a river flowed out of Eden to water the garden; and from there it divided and became four rivers. The name of the first is Pishon; it flows around the whole land of Havilah ... And the name of the second river is Gihon; it flows around the whole land of Cush. And the name of the third river is Tigris; it flows east of Assyria. And the fourth river is the Euphrates.

From our postflood perspective, rivers seldom divide into two downstream rivers, let alone four, and certainly rivers do not flow *completely around* a land—at least today. How can this be explained? [Note: The Hebrew word for “around” (*sabab*) means “encircled,” “circumference,” or “completely around.”]

Rain, as we know it, began after the flood. Some rain soaks into the ground, but most¹⁰ becomes runoff which *always drains downhill*. Even rain that eventually soaks into the ground flows downhill for some distance. It is this downhill flow that produces the branching, tributary patterns that characterize today’s rivers.

We must also remember that the flood-deposited sediments that average, at least on the continents, slightly more than a mile in depth. As explained in the liquefaction chapter [pages 195–213], most of those sediments were stratified into layers that are now parallel to the slope of the land. Therefore, even today’s subsurface water tends to flow in the direction of surface runoff when seeping downward from a permeable layer to a less permeable layer. Also, vast amounts of dissolved cementing agents, such as limestone and silica, were released from the subterranean chambers during the flood, so most of today’s sedimentary layers are cemented rock, much less permeable than preflood soils.

However, preflood precipitation was a very heavy dew, “a mist that rose up from the earth and watered the whole surface of the ground.” The total precipitation volume per year (as explained earlier), was much greater than today’s annual rainfall, and the heavy preflood dew was distributed much more slowly and uniformly during the cool of each night). Therefore, *preflood condensation had a much greater tendency to soak into the soil than rain*, and preflood groundwater would not have encountered layered strata or relatively impermeable sedimentary rock. In what direction would all that ground water flow? Always in the direction of decreasing pressure—not necessarily in the downhill direction as in today’s surface runoff. That means that preflood subsurface flow would eventually emerge as springs in valleys that would have been preflood river beds.

How does this explain the strange preflood rivers? Valleys frequently intersect other valleys, and hills are often surrounded by valleys. Therefore, preflood valleys would sometimes carry rivers that branched into other rivers, and a moatlike river might encircle a preflood hill. The high ground encircled by the “moat” could have been nearly continental in size. (Every continent today is surrounded by a topographic low.)

The flow of these preflood, moatlike rivers would have been slow and downhill. If there were no surface outlet, the width and depth of the moat would increase, so more evaporation would occur. Also, more of the river’s water would soak into the river bed and emerge as springs in preflood seas, the lowest regions on the preflood earth. Eventually, the moat would lose about as much water from evaporation and seepage as it gained from ground water draining into the moat. Rivers not constrained to enclosed valleys flowed into large seas. Today’s Tigris and Euphrates were probably named because they reminded the flood survivors of the preflood Tigris and Euphrates.

Preflood fog droplets also grew larger and faster than today for another reason. Without today’s main sources of condensation nuclei (volcanic debris, sulfur compounds from volcanoes, man-made pollutants, lightning-produced fires, sea salt from ocean spray, or dust and bacteria kicked up by high winds) there were fewer condensation nuclei. Condensing more moisture on fewer nuclei meant fog droplets grew larger and settled faster.

We can only marvel at the simplicity and efficiency of the preflood system for uniformly distributing, each day throughout the earth, water, a most precious resource. Today, we have droughts and local floods. Equally marvelous was the automatic preflood system for keeping time—a 360-day year and a 30-day lunar month, described on pages 153–192 and 592 and visible to everyone on the possibly cloudless earth. Each marvel gives new meaning

to the words, “*And God saw all that He had made, and behold, it was very good.*” (Genesis 1:31) We feeble engineers must exclaim to the Master Engineer, “Brilliant!”

First Rain. If it did not rain before the flood, how did the first rain form *at the very beginning* of the flood? As explained on pages 111–151, the drops of water falling at the beginning of the flood were not formed by condensing water. Instead, they formed by the upward-jetting spray from the fountains of the great deep.

Any credible flood explanation should explain why rain did not fall before the flood, how the fertile earth was watered, what supplied the rivers, how violent rain¹¹ fell so rapidly at the beginning of the flood, and why the rain ended after 40 days, even though the floodwaters rose until the 150th day when all preflood mountains were covered.

Also, if the flood's 40 days of rain formed by condensation, that rain should have stopped after a few days, because

falling rain would have removed the condensation nuclei. The hydroplate theory answers all these questions.

References and Notes

1. Translations of these verses raise frequent questions. Some believe that Genesis 2:5–6 contradicts Genesis 1. They dismiss Genesis as inaccurate or conclude that there are two creation accounts, Genesis 1 and Genesis 2. Item 3 on [page 537](#) refutes those opinions.
Other objections include the following: The creation of vegetation was described in Genesis 1:11–12, but later, Genesis 2:5 says there was no vegetation. Man was created in Genesis 1:27, yet Genesis 2:5 says there was “no man.” These objectors also claim that Genesis 2:5–6 says “there was no man to cultivate the ground,” but man must be present before cultivated plants could grow, and in Genesis 1, plants came before man.”
These misunderstandings disappear when one realizes that “vegetation” in Genesis 1:11–12 is the Hebrew word *deshe*, meaning the plant kingdom. In Genesis 2:5, “shrub” (*siach*) and “plant” (*eseb*) are special kinds of cultivated plants. Following the latter two words with “of the field” implies cultivation or farming of specific plants—not vegetation in general. Likewise, “beasts of the field” (Genesis 2:19–20, II Samuel 21:10, Psalm 8:7) are domestic animals, while “beasts of the earth” (Genesis 1:24–25) are wild animals. “Plants of the field” (cultivated plants) were probably not eaten until after the fall (Genesis 3:18).
My understanding of Genesis 2:5–6 is:
Crops were not yet growing on the newly created earth. The Lord God had not sent rain, and man did not yet toil for food. [Hard labor came after the fall.] Heavy fog—a mist that rose up from the earth—watered the earth.
2. Some authorities say the Hebrew word for “in the midst of” means to bisect. [See “[In the Midst of](#)” on [page 522](#).]
3. Had there been no variation in the raqia's thickness or density, portions of the raqia would not have settled to the chamber floor and established the foundation of the Earth. Because those foundations were established in one day, the differences in the raqia's thickness and density were considerable.
4. The seven references in the Bible to the “foundation of the Earth” are: Psalm 104:5, Proverbs 8:29, Isaiah 24:18, 40:21, 51:13, Jeremiah 31:37, and Micah 6:2
5. This analysis assumes that all the crusts potential energy heated the subterranean water. Some of that energy would have heated the crust instead.
6. Earth's preflood radius was about 180 miles larger than today, giving the earth's surface about 18 million additional square miles. [See “[Shrinking Earth](#)” on [page 159](#).]
7. Oceans and other large bodies of water change temperature more slowly than land. Today, large temperature contrasts between the two generate strong wind systems. With less surface water before the flood, these temperature contrasts, and the wind they generated, would have been weaker.
8. Forests retard winds much more than deserts. Before the flood, lush forests were extensive, so there were few, if any, deserts. Today, strong winds over such deserts as the Sahara lift dust (and bacteria) high into the stratosphere where they can drift for thousands of miles and, as nucleation sites, initiate rain.
9. Douglas Fox, “The Clouds are Alive,” *Discover*, April 2012, pp. 38–44.
10. The amount of rain runoff, depends on soil and ground cover characteristics, the slope of the land and rate of rainfall, and how dry or wet the soil is beforehand.
11. See Endnote 11 on [page 492](#).

Have Parts of the Collapsed Subterranean Chamber Been Found?

Probably. Prior to March 2014, I simply assumed the subterranean chamber was 10 miles below the earth's surface.¹ That assumption was based on the volume of rock the escaping subterranean water had to erode from the earth's crust during the flood to equal today's sediments and sedimentary rock, plus the rock fragments launched into space by the fountains of the great deep that became comets and asteroids. (Pages 301–377 show that the launched material later merged to become comets and asteroids.)

Trans-Neptunian Objects (TNOs). Since 1992, I have followed with great interest the discoveries of TNOs. So many of their characteristics match those of large asteroids:

their low density, color, percentage with moons, and concentration in doughnut-shaped belts (asteroid belt and Kuiper Belt). If TNOs were really large asteroids, then I could see how the Sun's energy spiraled the larger asteroids out beyond the orbit of Neptune, making them TNOs. [This is explained on pages 356–364.] But there was a problem: their combined mass is huge—a staggering 2–4% of earth's mass. If the debris launched from earth included the material in TNOs, then much more of the crust was removed during the flood. The subterranean chamber would have been much deeper than the 10 miles I had assumed. Ample energy was available to do this work, as explained on pages 379–433.

In March 2014, *Nature* published a paper [cited in Endnote 177 on page 377] showing that the twelve most distant TNOs all had a strange orbital characteristic. It was so unusual that the author, an astrophysicist, correctly pointed out that any explanation for TNOs must explain that characteristic. It was immediately obvious to me how, as large asteroids spiraled out beyond Neptune, a few would have received gravity boosts by the giant planets, flinging those TNOs even farther from the Sun and automatically giving them that strange property. Only then did I accept that the mass launched into space was much greater than I had previously thought, so the subterranean chamber must have been far more than 10 miles below Earth's surface.

A Collapsed Chamber or a Tectonic Plate? As water was expelled from the subterranean chamber during the flood, the chamber's roof settled onto the chamber's floor. Sandwiched between them should be a small amount of water that could not escape and magma produced by friction as the hydroplates skidded to a stop at the end of the rapid continental-drift phase. Since this was a geologically recent event, some of that magma should still be molten. One might think that seismic techniques—the analysis of echoes of earthquake waves bouncing off large discontinuities inside the earth—could identify that interface. Likewise, those who believe in plate tectonics might expect that seismic techniques could identify the base of plates that somehow drift over the mantle.

A Seismic Experiment. Unfortunately, earthquake wavelengths are too long to detect a collapsed subterranean chamber or the base of tectonic plates. However, in February 2015, researchers announced that they had produced seismic waves under New Zealand that were 20–50 times shorter by simultaneously exploding 1,100 pounds of

dynamite inside each of a dozen deeply-buried, steel containers. Echoes from those waves were collected by 1,178 seismometers. These researchers, using the reigning paradigm—plate tectonics—believe they have detected the base of a subducting tectonic plate almost 50 miles below the earth's surface, even though that surface is inclined only 12°–15° below the horizontal, rather than the expected 45°. ²

Most puzzling to the researchers is a 10-kilometer (6-mile) thick channel containing melted rock (magma) and/or water. If liquids separate a tectonic plate from the mantle below, then a circulating mantle could not be propelling the plate above. The old story that the mantle circulates and drags the plates forward would be false, because a horizontal shearing force from the mantle cannot be transmitted through a liquid. ³

Also, below the channel, seismic velocities increase, rather than decrease, as was expected based on plate tectonics.

The very existence of the channel itself is more of an enigma. How and why channelization would occur over a 10-km depth range is not known. ⁴

However, these discoveries are consistent with reflections off the collapsed subterranean chamber. Also, the much slower wave velocities measured in the channel indicate magma and/or water is trapped within the chamber's roof and floor. ⁴ Therefore, Assumption 1 on page 124 now places the depth of the preflood subterranean chamber at about 60 miles. That also would explain 3% of earth's mass in TNOs if the escaping subterranean water eroded equal amounts from the porous (and therefore easily erodible) chamber's roof and floor, so that the collapsed chamber is now an average of 30 miles below the earth's surface.

References and Notes

1. This was "Assumption 1" on page 124. It now reads 60 miles. As a first approximation, the volume of rock removed was the length of the rupture (46,000 miles) times its average width (about 1400 miles as seen in Figure 54 on page 121), times the unknown depth to the subterranean chamber. Much more difficult to estimate, and not included, was another source of rock removed by the escaping, subterranean water: crushed pillars and rock eroded from the chamber's floor and ceiling. During the flood, sediments deposited on the continents averaged slightly more than a mile in depth. Fewer sediment were deposited on today's ocean floors, because they opened up late in the flood, just before the floodwaters drained at the end of the rapid continental-drift phase.
2. T. A. Stern et al., "A Seismic Reflection Image for the Base of a Tectonic Plate," *Nature*, Vol. 518, 5 February 2015, pp. 85–88.
3. "The layer contains an estimated 2 percent molten rock, enough to drastically reduce the strength of the rock and essentially grease the overlying plate, like a layer of melted water beneath an ice skater's blades. Because it is sandwiched between the plate and the mantle, the layer also forms a barrier between the two. That separation challenges the prevailing view that flowing material in the mantle drives plate tectonics, says the geophysicist who led the study, Tim Stern of Victoria University of Wellington in New Zealand." Thomas Sumner, "Pacific Plate Slides Over Slick Layer: Mantle Might Not Drive Movements After All," *Science News*, Vol. 188, 26 December 2015, p. 27.
4. "The existence of such a localized channel probably has implications for the driving forces of plate tectonics and mantle dynamics." Catherine A. Rychert, "The Slippery Base of a Tectonic Plate," *Nature*, Vol 518, 5 February 2015, pp. 39–40.

Why did the Moon Roll—and When?

The same side of the Moon, throughout its orbit, faces the Earth. That is, the Moon spins once on its axis each time it orbits Earth. That spin axis is nearly perpendicular to the line connecting the Sun and Moon.

In 1998, an instrumented satellite orbiting the Moon found two craters that show every indication that they contain large amounts of water ice mixed with dirt.¹ Surprisingly, the craters are on exactly opposite sides of the Moon; each crater is 6 degrees from a lunar pole.

Water exposed to direct sunlight on the Moon will end up as 240°F steam. Those water molecules then bounce off the hot surface like ping-pong balls, but with the Moon's weak gravity and lack of atmosphere, each bounce covers several miles. Eventually, most of the water molecules will hit a cold spot, stick, and become frost. Today, the Moon's primary water traps are the floors of its permanently-shadowed, polar craters. Those floors are colder than the average temperature on Pluto. But why is ice in craters that are shifted 6 degrees from today's lunar poles, but not in craters *at* the poles, and why has ice remained in craters that periodically receive sunlight and are continually pounded by meteorites? The ice should have evaporated (sublimated) over millions of years.²

Let's look at two possible explanations; both are consistent with what would happen if a large mass were placed on or removed from the Moon. In both cases, the Moon's spin axis would remain fixed, but the Moon would roll so the maximum amount of mass is as far as possible from its spin axis. As the Moon rolled, its north and south poles (the points where the Moon's fixed spin axis penetrates its rolling surface) would shift. [This phenomenon is explained in Figures 82 and 81 on page 149.] Also, both theories can explain the presence of radioactive gases (radon) recently detected in two craters on the leading (western) face of the Moon's near side.³

Hydroplate Theory. Astronautics Professor R. Brown explains on pages 586–592 why (about 5 days after the flood began) 1.22% of the water and rocks launched by the fountains of the great deep began striking primarily the leading face on the near side of the Moon. Over time, more water and solid debris, following less direct routes, hit many

other places around the Moon. Much of the water that hit the Moon became trapped within months on the cold floors of the early craters that formed at the lunar poles.

Some rocks that hit the Moon were radioactive. [See **“The Origin of Earth's Radioactivity”** on pages 379–433.] Within decades after the flood, larger rocky bodies—especially asteroids—began impacting the Moon. [See pages 301–377.] In 1968, the largest lunar impactors, called *mascons* (or mass concentrations), were discovered on the Moon. [See **Figure 179** on page 320, and notice that they are located near the Moon's equator. This implies that they were the unbalanced masses that rolled the Moon and shifted its ice-filled craters.] All of this occurred only about 5,000 years ago. [See **“When Was the Flood, the Exodus, and Creation?”** on pages 482–484.]

Volcanic Theory.⁴ Over billions of years, comets and asteroids brought water to the Moon. Eventually most of that water became concentrated in the bottoms of craters at the lunar poles. The radioactive gases recently detected coming from two craters on the leading face of the near side of the Moon suggest that volcanic activity expelled radioactive rocks from inside the Moon.³ That would have shifted internal mass and altered the Moon's balance, causing it to roll relative to its spin axis and shift the ice-filled craters that were initially located at the Moon's north and south poles.

Questions. The volcanic theory raises nine questions. How did radioactivity develop inside the Moon? Why has ice, which periodically receives sunlight because it is no longer at the lunar poles, not sublimated into the vacuum of space?² Was it because the Moon's roll happened recently, such as in the last 5,000 years? If ice built up over millions of years at the lunar poles, shouldn't there be a trail of ice-filled craters, not just the two that are offset 125 miles from the poles?⁵ Doesn't this imply a rapid roll? Because mascons (buried asteroids) are all near the lunar equator, did they cause the Moon's roll? How could asteroids hit the near side of the Moon? Isn't it shielded by Earth? It is now acknowledged that comets and asteroids did not provide Earth's water. [See **“Earth: The Water Planet”** on page 27.] Why then does the volcanic theory say comets and asteroids brought water to the Moon? The hydroplate theory answers these and other questions.

References and Notes

1. “These data are consistent with deposits of hydrogen in the form of water ice that are covered by as much as 40 centimeters of desiccated regolith within permanently shaded craters near both poles,” W. C. Feldman, et al., “Fluxes of Fast and Epithermal Neutrons from Lunar Prospector: Evidence for Water Ice at the lunar Poles,” *Science*, Vol. 281, 4 September 1998, p. 1489.
2. “... how could [the ice deposits] have remained there for so long, given that they are in sunlight?” Ian Garrick-Bethell, “Signs of a Wandering Moon,” *Nature*, Vol. 531, 24 March 2016, p. 456.
3. See Endnote 153 on page 432.
4. M. A. Siegler et al., “Lunar True Polar Wander Inferred from Polar Hydrogen,” *Nature*, Vol. 531, 24 March 2016, pp. 480–484.
5. “Furthermore, one might expect ice palaeopoles to have formed everywhere along this polar-wander path, raising the question of why they are found only at the locations observed in the current study.” Garrick-Bethell, p. 456.

When Was the Flood, the Exodus, and Creation?

First the flood. Two independent methods—one scientific and the other biblical—will be used to calculate the date the flood began. Over the last 2,000 years, dozens of conflicting biblical chronologies have been proposed. Bible scholars and archaeologists frequently debate those differences. Although most biblical chronologies give dates for the flood that are reasonably close to the scientific conclusion, which will now be explained, only five biblical proposals lie within the ± 100 year accuracy of the scientifically derived date.

A Scientific Answer:

“**The Origin of Comets**” on pages 301–335 explains why rocks, dirt, and water launched by the fountains of the great deep soon merged in space to form comets. Consider what we could learn if each comet’s fairly constant—almost clocklike—orbital period around the Sun never changed. We could project each comet back beyond its earliest recorded sighting and find the date when *all comets* passed simultaneously near the Earth. That would provide an *astronomical fix* for the date of the flood.

However, planets gravitationally perturb comets,¹ changing their periods, usually slightly, although large perturbations can happen when a comet passes very near a planet. For example, forty-five consecutive orbits of comet Halley have been computed back to 15 October 1403 B.C., when its period was 69.86 years. The change in period, from one orbit to the next, was usually less than 1.5 years, and no change was greater than 2.8 years. Can we estimate past positions of some clocklike comets accurately enough to date the flood?

Computer Simulations: A Technique That Will Not Work. Many computer programs have been developed to calculate past (or future) comet positions. The more sophisticated techniques give greater accuracy but require much greater computer capabilities. All programs work essentially the same way. From a comet’s known position at a given time, all gravitational forces acting on it are calculated, especially those of the Sun and planets. The computer then calculates from where those forces moved the comet during a brief time period, such as one day. Next, the net gravitational force acting on each planet is calculated and those planets are moved back by that same time interval. This “marching” process, one step at a time, is repeated for as long as one attempts to project the comet’s position back in time—or into the future. Similar procedures are used to find past and future positions of asteroids and spacecraft.

As you might expect, hundreds of computer multiplications are required for each step in time. Every number stored in a computer is limited to a fixed number of digits. Let’s call that number x . Because the product of two numbers with x significant digits is a number with $2x$ digits, the x least significant digits must be discarded when the computer

stores that product. Those lost numbers become an error. Also, the slightest error in a comet’s (or planet’s) starting position affects the next computed position. These errors grow exponentially as the marching solution advances, so after about 4,000 years, the projection becomes a blur. Therefore, this technique cannot determine if comets came from near Earth more than 4,000 years ago. Secular history for several postflood cultures is well established for the last 4,000 years, so the flood was even earlier.

A Statistical Solution: A Technique That Does Work. The oldest recorded observation of Halley’s comet was made by Chinese astronomers in 239 B.C. It passed *perihelion* (the point on an orbit closest to the Sun) at 2:49 A.M. on 25 May 239 B.C., based on Greenwich Mean Time and the Julian calendar.² From that date, Halley’s orbit has been numerically integrated (marched back in very short time increments) to 1403.80 B.C., when its period was 69.86 years.³

What was its previous period? The best guess would be 69.86 years, although it could be slightly more or less. The changes in the lengths of consecutive orbital periods vary with a standard deviation, σ . A small σ indicates a narrow range of variations; a large σ indicates a wide range of possibilities. Based on all known periods of Halley’s comet, $\sigma = 1.56$ years. That is, there is almost a 2 out of 3 chance the previous period was within 1σ of 69.86—between 68.30 and 71.42 years. There is a 95% chance the previous period was within 2σ of 69.86—that is, between 66.74 and 72.98 years.

When was its perihelion passage 2 periods ($N=2$) earlier? That best guess would be 139.72 (2×69.86) years earlier. However, with each backward step, the total error grows, *but at a diminishing rate*, because of compensating errors.

If in the distant past, the most clocklike comets all passed close enough to Earth in a particular year, we could be confident that was not a statistical fluke. Therefore, that would be the year the flood began.

Selecting the Most Clocklike Comets. An ideal clocklike comet would have:

- long orbital periods and high angles of inclination, so the comet spends almost all its time far from the planets, minimizing their gravitational perturbations,
- at least 2,000 years of ancient observations, so fewer orbits are needed to project it back to reasonable dates for the flood (4,000–6,000 years ago), and
- hundreds of recorded observations that have been smoothly integrated into one marching solution.

The most authoritative source of information for all known comets is the *Catalogue of Cometary Orbits 2008* (17th Edition).⁴ It lists on page 157 two comets that easily surpass all other comets in meeting this criteria: **Comet Halley and Comet Swift-Tuttle**. They are unique in having extremely long periods, high angles of inclination,

and hundreds of recorded, eye-witness observations going back to 239 B.C. and 68 B.C., respectively. Furthermore, powerful computer simulations, which took into account the perturbations of all planets, large moons, and large asteroids have accurately projected these comets farther back to 1403.80 B.C. and 702.30 B.C., respectively.⁵ If any comets are sufficiently clocklike, it will be these two. If, as we project them back, we find a time when they should have passed perihelion almost simultaneously, our confidence increases, with high statistical confidence, that *the material that merged to become those comets* was launched from Earth. The case will be made. Bingo!

Comets Halley and Swift-Tuttle were projected back to the time interval 4,000–6,000 years ago—the window of time that includes dozens of proposed, biblically-based dates for the flood. The tightest clustering occurred **in the year 3290 B.C.**,⁶ after exactly 27,000 orbits for comet Halley and 20,000 orbits for comet Swift-Tuttle.

But is that tentative date statistically significant? In other words, what if we repeated the above procedure that arrived at the year 3290 B.C., but began each comet's backward projection at a random point on its orbit instead of at perihelion? What percent of those random trials would cluster both comets—and Earth—at least as tightly as was achieved with the true, oldest known⁷ perihelion? The answer turns out to be less than 1.0%. **Therefore, we can be more than 99% confident that we have an astronomical fix for the flood around 3290 B.C.** and that massive amounts of rocks and water (ice) launched into space by the hypersonic fountains of the great deep later merged by known forces to become comets.

Table 29 gives *each comet's* expected 1σ error in arriving at 3290 B.C. Assuming the 99% confidence level is high enough to conclude that the material in both comets was launched from Earth at the same time, that single time distribution has a 1σ error of ± 100 years—smaller than each comet individually.⁶

Table 29. Most Clocklike Comets

Comet	Oldest Known ⁷		N	1 σ Error ⁶ in Predicting	
	Perihelion	Period		Successive Periods	Flood Date
Halley	1403.80 B.C.	69.86 years	27	1.56 years	130 years
Swift-Tuttle	702.30 B.C.	129.33 years	20	2.98 years	159 years

Notice that 3290 B.C. is the most likely year of tightest clustering *of only their perihelions*. These comets would have been nearest Earth's orbit a few months before or after those perihelion passes—as they approached perihelion or after they left perihelion. Those errors amount to only a few months—an insignificant error in comparison with the ± 100 year uncertainty. Therefore, the most clocklike comets were clustered near Earth in **3290 \pm 100 B.C.**

A Biblical Answer:

For the last 2,000 years, hundreds of Bible scholars have tried to date the beginning of the flood. Bishop Ussher

(1581–1656) proposed the most well-known date: 2348 B.C. It and Ussher's date for the creation (4004 B.C.), were printed in the margins of many Bibles, beginning in 1611 with the King James Bible. However, there are many proposed biblical dates for the flood,⁸ so some confusion has resulted and the issue has been unresolved. Why do the dates differ?

A typical, *but not necessarily correct*, biblical calculation for the year the flood began is shown in Table 30. If all its entries were correct, then summing the years would give 2519 B.C. as the date of the flood. Unfortunately, several entries (rows) contain major uncertainties:

Table 30. Possible Date for the Flood Based on the Bible

	Event	Years	References
1	Abraham (Abram) was born 352 years after the flood began.	352	Gen 11:10–12:4, Acts 7:4
2	Jacob entered Egypt 290 years after Abraham was born.	290	Gen 21:5, 5:26, 47:9
3	Jacob's descendants were in Egypt for 430 years.	430	Gen 15:13–16, 47:9, Ex 12: 40, Acts 7:6, Gal 3:17
4	The Exodus from Egypt occurred 480 years before the fourth year of Solomon's reign.	480	I Ki 6:1
5	In 967 B.C., during his fourth year as king, Solomon began to build the Temple in Jerusalem.	967 B.C.	historical records I Ki 6:1
Total:		2519 B.C.	

Uncertainties in Table Table 30:

Row 1: The ages given in Gen 11:10–12:4 are based on the Masoretic text (also called the Hebrew text). Other major Bible manuscripts give totals that differ from the Masoretic's 352 years. For example, the Septuagint (Alexandrinus) manuscript gives 1072 years; the Septuagint (Vaticanus) manuscript gives 1172 years; the Samaritan Pentateuch gives 942 years. [See Table 33 on page 512.]

Controversy surrounds Terah's age when his son Abraham was born. While some say it was 70 years, my possibly incorrect reasons for using 130 years are given in Endnote 1 on page 505.

Row 3: The Masoretic manuscript says, in Ex 12:40, that Jacob's descendants were in Egypt for 430 years, but Septuagint and Samaritan manuscripts say that Israel's time in Egypt "*and in the land of Canaan*" was 430 years. Those who hold to the Septuagint or Samaritan usually assume that 215 years were spent in Canaan and 215 years were spent in Egypt. Josephus (37–100 A.D.), the famous Jewish-Roman historian, also took that position.

Row 4: Gerald E. Aardsma has claimed that I Ki 6:1 should have given the time period as 1480 years, instead of 480 years. [See *Radiocarbon and the*

Genesis Flood (El Cajon, California: Institute for Creation Research, 1991), pp. 82.]

Row 5: Some authorities give slightly different dates for the fourth year of Solomon's reign.

Confirmation 1. With the flood now dated at 3290 ± 100 B.C., enough time has transpired for the oldest living tree (now 5,062 years old) to take root and grow. Almost all other biblically based dates for the flood do not allow enough time. [See Endnote 9 on page 509.]

Confirmation 2. For a remarkably consistent, but independent, date for the flood, see “**Genetic Discoveries**” on page 511.

Only five of the dozens of proposed biblical dates for the flood fall within the **3290 \pm 100 B.C. time period.**⁸ All five dates place Jacob's descendants in Egypt for 430 years

(not 215 years).⁹ Most of those dates also favor (1) using the patriarchs' ages given in the *Septuagint*,¹⁰ (2) assume Terah was 130 years old when his son Abraham was born, and (3) prefer Usher's chronology for the Hebrew kings. If those assumptions, which have been a source of uncertainty and debate for centuries, are now resolved based on this comet study and the astronomical fix, **biblical chronology falls into place, give or take 100 years: the flood began in 3290 B.C. The creation was in 5532 B.C.,⁶ and the Earth is $7,500 \pm 100$ years old.**

The Exodus. Timothy Mahoney, using interviews of Hebrew scholars, archaeologists, Egyptologists, and an amazing array of evidences, concluded that the Exodus occurred in **1450 B.C.**¹¹—the same date for the Exodus based on the flood beginning in 3290 B.C. and the patriarch's ages given in the *Septuagint*.

References and Notes

- Comets are also acted upon by a slight thrusting force as they pass near the Sun, heat up, and expel vapor and other materials that form their tails. Much of this jetting effect can be calculated, although small errors remain.
- The Julian calendar, begun by Julius Caesar in 46 B.C., was used throughout most of Europe until it was superseded by the Gregorian calendar, commissioned by Pope Gregory XIII in 1582. Today, almost all countries rely primarily on the Gregorian calendar. The Julian calendar had the same twelve months and the same number of days per month as we have today, but did not handle leap years as accurately.
 - There is no zero year. Therefore, 31 December 1 B.C. was followed the next day by 1 January A.D. 1. The interval between those dates was only 1 day, but a routine subtraction would give almost a year. To get correct time intervals between B.C. and A.D. dates, and to avoid the complication that some years were leap years, all calendar dates in this comet study were converted to Julian dates—not to be confused with the Julian calendar. Julian dates are simply a count of the 24-hour days since noon on an arbitrary day—1 January 4713 B.C. As of this writing, the Julian date is 2,456,482.
- A comet's period is defined as the time it takes the comet to complete one orbit, from one perihelion to the next. The period is not the calculated time for one orbit if all perturbing forces were suddenly removed—what is called the *osculating period*. This incorrect period is what is usually listed in comet catalogues. For comets and this study, the difference is significant, because planetary perturbations can vary greatly throughout a comet's elongated orbit.
- Brian G. Marsden and Gareth V. Williams, *Catalogue of Cometary Orbits 2008*, 17th edition (Cambridge, Massachusetts: Minor Planet Center, 2008).
- Donald K. Yeomans and Tao Kiang, “The Long-Term Motion of Comet Halley,” *Monthly Notices of the Royal Astronomical Society*, Vol. 197, 1981, pp. 633–646.
 - Kevin Yau et al., “The Past and Future Motion of Comet P/Swift-Tuttle,” *Monthly Notices of the Royal Astronomical Society*, Vol. 266, 1994, pp. 305–316.
- For calculation details, see “**Calculations That Show Comets Began Near Earth**” beginning on page 572.
- The oldest know period and perihelion date are based on the precise calculations contained in the papers listed in endnote 5.
- Thanks to Dr. Terry Hurlbut for his work on Old Testament chronology from Creation to the death of Nebuchadnezzar II in 562 B.C. and for identifying the different assumptions various scholars have made. Dr. Hurlbut's work can be read at http://creationwiki.org/Biblical_chronology_dispute.
- Had Jacob and the approximately 70 members of his family, their households, and their descendants been in Egypt only 215 years, it is highly unlikely that their numbers could have grown in 215 years to become the 600,000 men of military age—and a few million other men, women, and children—that participated in the Exodus. [See Exodus 12:37.] Acts 7:6 also contradicts the 215 year interpretation.
- Most Bibles have an Old Testament based on the Masoretic text, so an unexpected surprise from this comet study is that **the patriarchal ages** in the *Septuagint* are probably more accurate than those in the Masoretic text. This is not to say that our copies of the *Septuagint* best represent the original Old Testament, although the *Septuagint* is the oldest known translation we have today of the Old Testament. (It is also the official text in the Greek Church.) As explained on page 505, relatively minor round-off errors are undoubtedly imbedded in the ages of the patriarchs in all translations, because, statistically speaking, too many of their ages end in 0 or 5.
 - “*New Testament authors* [and even Jesus] *show a clear preference for the Septuagint over Masoretic readings.*” R. Grant Jones, “Notes on the Septuagint,” p. 11 at: <http://www.sheekh-3arb.org/islam/books/septu.pdf>.
 - “*Jesus himself follows the traditional Septuagint wording in condemning the Pharisees' traditions (Matthew 15:8-9).*” Ibid.
- Timothy P. Mahoney, *Patterns of Evidence: Exodus* (St. Louis Park, Minnesota: Thinking Man Media, 2015), 392 pp.

Did the Flood Last 40 Days and 40 Nights?

No. This is a common misunderstanding. Violent *geshem*¹ rain lasted for 40 days and 40 nights, but the floodwaters continued to rise and eventually covered all preflood mountains 150 days after the flood began. *People and animals were in the Ark for more than a year—7 months after the Ark landed*, because conditions outside the Ark

were hostile. [To see why, read “[Why Did the Floodwater Drain So Slowly?](#)” on page 503.]

The flood was the deadliest event in human history, and it occurred in the most precisely recorded year in the Bible. Here are some flood-year events. (“D-day” marks the start of the flood. D-7 represents one week before the flood began.)

Table 31. Log of the Flood Year²

Day (Duration)	Reference in Genesis	Event	Comments
D - 7	7:1, 4, 10	Loading the Ark begins. Noah, his wife, their three sons, their sons’ wives, and representatives of all air-breathing land animals enter the Ark.	
D	7:11, 13	Humans enter the Ark for the last time. Then, on this single day, all the fountains of the great deep burst open³ and rain¹ begins. [See Figures 42, 57, and 58.]	This occurred on the 17th day of the 2nd month. Noah was 600 years old.
(40 days)	7:12, 17	Rain ¹ falls upon the earth. The Ark is <i>lifted above the earth</i> . The waters increase greatly ⁴ upon the earth.	Evidently, the Ark was loaded on dry land.
(150 days)	7:19, 24	Waters prevail [rise with mighty power] upon the earth. They eventually cover all the earth’s preflood mountains.	Notice that the waters rose for 110 days after 40 days of “ <i>geshem</i> ” rain.
D + 150 days	8:1–4	A wind passes over the earth. The waters begin to subside; the fountains of the deep and the floodgates of the sky close, and the rain is restrained. The Ark rests upon the mountains of Ararat , and the water steadily recedes.	Months were probably 30 days long. Compare 8:3 and 8:4, and note that 8:4 begins with “And.” At the end of the flood, rapid rising of mountains displaced air and caused the wind. ⁵ [See pages 486–487.]
D + 224 days	8:5	The tops of the mountains become visible.	Noah saw at least two peaks.
D + 264 days	8:7	Noah sends out a raven, a scavenger, so it may not have returned.	The birds may have been released at seven-day intervals. (Study Genesis 8:10.) This hints at a seven-day week and a Sabbath—a commemoration of the creation week. [See Genesis 7:4.] Because the dove—a non-scavenger—returned to Noah, Noah could deduce that little food was growing on earth.
D + 271 days ⁶	8:8–9	Noah sends out a dove, a non-scavenger. It returns to Noah.	
D + 278 days	8:10–11	Again, Noah releases a dove. It returns with an olive leaf.	
D + 285 days	8:12	Noah releases a dove for the third time. It does not return.	
D + 314 days	8:13–14	Noah removes the covering of the Ark and sees the dry ground.	Noah stayed in Ark 57 more days. Conditions outside were unsafe. [See page 503.]
D + 371 days	8:15–19	God tells Noah to off-load the Ark.	Humans and animals probably migrated soon afterwards to lower, warmer, higher-pressure elevations.

References and Notes

1. גֶּשֶׁם transliterates as *geshem*. It is the most violent rain. In Ezekiel 13:11–13, *geshem* rain destroyed mortared walls.
2. Durations are based on the Masoretic text. The Septuagint text has Noah in the Ark exactly one year. Other manuscripts of Genesis give slightly different times.
3. “Burst open” is a loose translation of בָּרַחַץ, which means a violent cleavage. Isaiah 34:15 and 59:5 uses it to describe the hatching or breaking forth from inside an egg; i.e., the breaking of a thin shell or crust. Numbers 16:31 uses it to describe the splitting open of the earth. [See also Psalm 78:15.]
4. “Greatly” is an understatement. “Greatly, greatly” would be a more accurate translation, because Hebrew uses the

double superlative construction. This construction is used in only one other place in the Old Testament—in Genesis 17:2 where God makes a covenant with Abraham.

5. Noah and the Ark certainly experienced high winds during the preceding five months. So, the wind that began on the 150th day must have been unusual and extreme.

Noah released the raven 114 days after the wind began, presumably to learn how far the waters had receded. Noah would not have done this if the extreme wind were still blowing, because the raven would have had difficulty returning to the Ark. Therefore, the wind probably lasted less than 114 days.

6. This assumes the dove was released seven days after the raven.

Could Earth's Mountain Ranges Form in Less Than an Hour?

If you are surprised (or doubt) that all of Earth's major mountain ranges formed in less than an hour, then let's begin with something easier to visualize and analyze.

The reason the events of the flood have, for centuries, remained hidden—and for many, unbelievable—is because of the flood's magnitude. Its global extent, gigantic forces, energy, and extreme and diverse consequences were far beyond our everyday experiences, even though the flood is etched in the memory of most cultures and religions.

So let us

- start with the main assumption on page 124,
- never violate a law of physics,
- consider all relevant scientific evidence (what we can see and measure today and that others can verify),
- not be afraid to think big or follow the evidence, and
- not be distracted by those who refuse, or are unable, to follow the above steps.

We will see many confirmations that we are on the right track, because the consequences of the flood solve hundreds of mysteries that have perplexed scientists for centuries, if not millennia. However, to do this, we must be willing to think across multiple scientific disciplines.

An Analogy. Imagine that a long, massive train lost its brakes and is steadily gaining speed as it accelerates down a high mountain. Eventually, this runaway train will crash. Its many boxcars will suddenly decelerate, compress, crush, and jackknife. In this analogy, the mountain the train is racing down represents the steep slope from the suddenly upbuckled Mid-Atlantic Ridge. Tipped and crushed boxcars represent today's compressed and buckled mountain ranges. [See, for example Figure 50 on page 117. Thousands of other examples could be given.]

The flood began with the globe encircling rupture. The escaping fountains of the great deep eroded and widened the rupture, which removed weight from the chamber floor directly below the rupture. Eventually, the Mid-Atlantic Ridge sprung upward. As shown in Figure 89 on page 160, this pulled the Pacific plate down steepening even more the hydroplates slide down and away from the rising Mid-Atlantic Ridge. (The Americas hydroplate slid west, and the Europe/Asia/Africa hydroplate slid east.) Within one day,¹ the Atlantic basin opened up.

These huge elevation changes during the continental-drift phase are staggering. We must remember that gravity always tries to squeeze planet-size bodies into the shape of a sphere, so Earth's spherical shape was restored shortly after the flood, but as time passed, changes became very slow, almost undetectable, except with instruments. Nevertheless, after thousands of years, earth increasingly resembles a sphere with mountains and deep ocean basins.

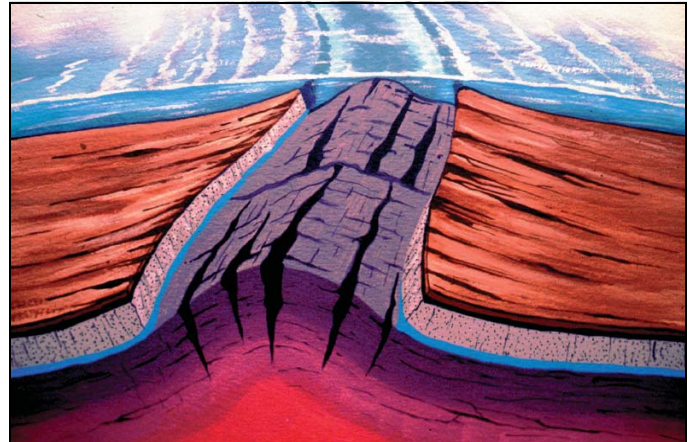

Figure 242: Birth of Mid-Atlantic Ridge and the Ultimate Slippery Slope. Ice is slick, especially if one is on ice skates, because ice directly under the great pressure of the thin metal blades normally turns to liquid water. Ice skaters are actually sliding on liquid water.

Imagine how fast a skater—or massive hydroplate—would slide down a mountainside the size of the Mid-Atlantic Ridge, riding not on liquid water but on supercritical water (SCW), which is 50 times slicker than liquid water!² SCW has a viscosity (frictional resistance) about one-fiftieth that of liquid water; SCW provided almost no resistance to the massive sliding hydroplates; it was much like riding a few thousand miles down a steep slope on a cushion of air.

Contrast that with the century-old problem geologists have trying to understand how 30–60-mile thick, continental plates can scrape over and plow through mantle rock, which is a solid, not a liquid. Obviously, the plates cannot. Geologists have a serious problem.

Our fictitious train has the mass of a continent and our mountain rises from the floor of the subterranean chamber, directly below the widening rupture and 60 miles below earth's pre-flood surface. [See Figure 242.] Some have wondered why the Mid-Atlantic Ridge is much higher and steeper than the rest of the Mid-Oceanic Ridge. It is because the Mid-Atlantic Ridge rose first and relieved much of the internal upward pressure on the rest of the Mid-Oceanic Ridge.

The hydroplates accelerated much faster than our fictitious train, because a train has many moving, grinding parts, including metal wheels that roll noisily on metal tracks bending around curves. All of that creates friction; the faster the train, the greater the friction. However, as explained in Figure 242, the hydroplates (our real train) slid *straight down the ultimate slippery slope*—which was supercritical water, 50 times slicker than ice.²

When one compares the gigantic mass of our continental-size train (the driving force) with the almost negligible resistance from the slippery slope, friction can safely be neglected. Therefore, the speed of our fictional train depends only on gravity and the downhill slope from the center of the rising Mid-Atlantic Ridge to the sunken Pacific plate.

Figure 243: Timing of Events, Continental-Drift Phase. This velocity-time diagram (used frequently by engineers) allows us to estimate how rapidly mountain ranges formed. With this type of diagram, positive slopes represent acceleration, and negative slopes, deceleration. The colored areas represent distances traveled. The acceleration portion of the continental-drift phase (shown in blue) opened up the 4,000 mile wide Atlantic basin in T hours. The entire continental-drift phase lasted somewhat less than 24 hours.¹ The decelerating portion (shown in red), which pushed up all of earth's major mountain ranges, lasted less than (24 - T) hours. Researchers have estimated how much mountain building has shortened continents on various great circles. These estimates generally range between 100 and 200 miles.³ If we took the average of these two distances (150 miles) and both the acceleration and deceleration were constants, then the compression event and mountain building lasted less than an hour—or more precisely, less than 0.87 hours. If you calculate the height of the two triangles, you will see that the maximum velocity of each hydroplate was about **170 miles per hour!**

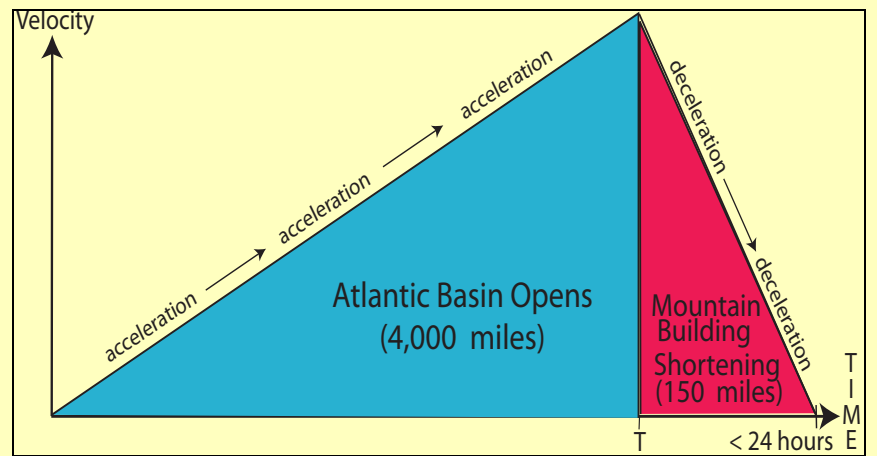

How long was the continental-drift phase? Our fictional train accelerates faster than a steel ball rolling straight down such a slope.⁴ Initially, the speed is slow, but every second it increases, until resistance is met and the compression event begins. The continental-drift phase lasted no more than 24 hours.¹ Figure 50 on page 117 shows one of the consequences.

How rapidly did earth's mountains form? Although our runaway train picked up speed slowly, if, after hours of acceleration, its wheels suddenly fell off, the train would rapidly decelerate and crash. Likewise, the compression event began after most of the Atlantic had opened up. The hydroplates began to meet major resistances, ran out of lubricating water, decelerated, crushed, and buckled. Earth's mountain ranges were pushed up in less than an hour—all with fossils of sea life on top. [See Figure 243.]

This is consistent with Genesis 8:1 which says that a great wind “passed over the earth” at the end of the flood. We live

under an “ocean” of air—our atmosphere. The extremely rapid uplift of all earth's major mountain ranges displaced the atmosphere, causing great winds to flow down the rising mountains. It was like a global tsunami, but instead of an earthquake suddenly lifting a portion of the ocean floor and creating a tsunami (a giant water wave that travels thousands of miles), the compression event suddenly uplifted earth's major mountain ranges and produced a great “wind that passed over the earth.” Had mountains been pushed up slowly—the conventional view—that extreme wind within the atmosphere would not have happened.

Some who read that a great “wind passed over the earth” at the end of the flood think that is one more reason to regard the flood account as mystical or unrealistic. Instead, gigantic events were happening that we don't experience today. The flood account is quite accurate. In fact, the flood year is the most precisely recorded year in the Bible.

References and Notes

1. Genesis 7:20,24 says that the floodwater covered all earth's pre-flood mountains on the 150th day of the flood. Then Genesis 8:1 states that “God caused a wind to pass over the earth and the waters subsided.” Finally, at the end of the 150th day, the waters steadily receded from the earth, and the Ark landed on the mountains of Ararat. (Genesis 8:3–4).

The hydroplate theory describes these events in Genesis in a broader, easier-to-visualize, physically meaningful way:

The floodwaters prevailed on Earth for 150 days (Genesis 7:24), steadily rising 15 cubits (about 22½ feet) above all Earth's pre-flood mountains. Then on the 150th day of the flood, the continental-drift phase began. Hydroplates began sliding (accelerating, actually) downhill on a very thick, slick layer of supercritical water, opening up what would become the 4,000-mile-wide Atlantic Ocean. No more than 24 hours later, the compression event crushed and

buckled up Earth's major mountain ranges. The great wind must have been indescribably powerful all over the Earth. At the end of the 150th day, it was clear that the floodwaters were receding, because the Ark landed on the mountains of Ararat.

The 150th day was literally earthshaking.

2. Lester Haar et al., *NBS/NRC Steam Tables* (New York: Hemisphere Publishing Corporation, 1984), p. 263.

3. See *Introductory Geology* by Thomas Chrowder Chamberlin and Rollin D. Salisbury (New York: Ulan Press, 2012), p. 224.

4. Even neglecting wind resistance, a steel ball rolling down a smooth slope moves more slowly than a frictionless slab sliding down the same slope. This is because some of the ball's initial potential energy at the top of the slope must produce the ball's angular velocity (rotational speed), leaving less energy for the ball's linear velocity (speed).

Is the Hydroplate Theory Consistent with the Bible?

Without hearing from eyewitnesses, police can usually reconstruct the general outlines of an automobile accident by carefully studying the evidence, such as skid marks and wreckage. Likewise, some details of the flood can be pieced together just by studying its wreckage. Part II of this book is such a study. However, witnesses provide

details consistent with the physical evidence as well as information we might never learn elsewhere. Here, you will see that the hydroplate theory is also consistent with the Bible, which records eyewitness accounts of the flood. [Table 32](#) shows the close correspondence between the biblical descriptions of the flood and the hydroplate theory.

Table 32. Comparison of Biblical Chronology with Major Events of the Hydroplate Theory

Biblical Chronology (Eyewitness Accounts)	Hydroplate Theory (Scientific Evidence)
<p><i>Day 2 of Creation Week:</i> Water covered the earth. (Gen 1:2) Then “a <i>raqia</i>” separated liquid water above from liquid water below. (Gen 1:6–7)</p>	<p>During Creation Week: A layer of water was below earth’s crust (a <i>raqia</i>, or pressed-out solid). [See “What Does ‘Raquia’ Mean?” on page 523 for further details.] Earth’s surface waters were above the crust. Because the crust was initially so flat, those surface waters covered the entire earth.</p>
<p><i>Day 3 of Creation Week:</i> The waters below the heavens were gathered into one place, and the dry land appeared. (Gen 1:9)</p> <p>[See Figure 240 on page 476.]</p>	<p>The <i>raqia</i>—earth’s 200,000,000-square-mile rock crust—rested on a layer of trapped subterranean water. The heaviest (densest, thickest) portions of the crust rapidly sank into the subterranean water, forming depressions at earth’s surface. Because a fixed volume of water was trapped under the crust, the displaced subterranean water lifted the lightest portions of the crust out of the surface water. <i>The dry land appeared.</i> (Gen 1:9) The water above the crust then drained into the depressions, forming seas. [See “What Triggered the Flood?” on pages 469–475.]</p>
<p>It did not rain before the flood. Instead, “a mist used to rise from the earth and water the whole surface of the ground.” (Gen 2:5–6)</p> <p><i>Note: For water to become a mist, heat must be added to the water. For this to happen uniformly and regularly over the whole earth, requires huge amounts of continuously generated heat from inside the earth.</i></p>	<p>Before the Flood: The subterranean water, heated by tidal pumping, quickly¹ became supercritical.² Certain minerals in the granite crust, such as quartz, readily dissolved in the supercritical water, making the lower crust porous. [See “Recorded Ancient History” on page 471.] Heat from tidal pumping could then rise continuously by convection through the lower crust and evaporate ground water (not connected to the subterranean water) near earth’s surface. With such a humid atmosphere, heavy dew settled to the ground each night as temperatures fell below the dew point, providing a marvelous and simple system for daily distributing pure water for all life—not too much and not too little. This also cleaned the atmosphere, and produced cooling during the day and heating during the night.</p>
<p>At the end of the creation week, “God saw that all He had made was very good.” (Gen 1:31) Because earth’s radioactivity is harmful to life, radioactivity must not have been on the early earth.</p>	<p>Radioactivity did not exist on earth prior to the flood. The flood produced earth’s radioactivity. [See “The Origin of Earth’s Radioactivity” on pages 379–433.]</p>
<p>Human violence and great sin had spread throughout the earth. (Gen 6:5–12)</p> <p>About 2,000 years after creation, all the fountains of the great deep³ burst open on one day and the flood began with “<i>geshem</i>⁴ rain”—as if “flood gates” in the sky had opened up. (Gen 7:11)</p>	<p>Rupture Phase: Because the lower crust was porous, it was weaker than solid granite. The elevated pressure in the subterranean chamber (from tidal pumping) and in the water filling the voids in the lower crust stretched the crust, much like a stretched rubber band. Some event, perhaps resulting from human violence, added additional stress to the crust, pushing it to its failure point. A tension crack then propagated around the earth in about 2 hours, releasing subterranean water. Fountains of muddy water and rocks jetted high above the earth and became extremely cold in seconds—almost absolute zero (-460°F).⁵ Muddy hail falling from the supercold fountains buried and froze mammoths. Comets, asteroids, and meteoroids formed from some of the high velocity water and rocks that escaped earth. [See pages 267–374.]</p>
<p>The 40 days and 40 nights of “<i>geshem</i> rain” ended. (Gen 7:4,12)</p>	<p>Flood Phase: The fountains of the great deep were suppressed. [See “The Water Prevailed” on page 491.] Sediments from the muddy water buried (and eventually fossilized) plants and animals.</p>
<p>Floodwaters rose until the 150th day, when they covered all preflood mountains. (Gen 7:19–24)</p>	<p>High-pressure water continued to gush up into the floodwaters. Liquefaction sorted sediments and dead plants and animals. Salt domes, coal, oil, and methane began forming.</p>
<p>150th Day: A wind passed over the earth. Waters slowly began to subside.⁶ The Ark landed on the mountains of Ararat. (Gen 8:1–4)</p>	<p>Continental-Drift Phase: The Mid-Atlantic Ridge buckled up, and the Atlantic floor rose. The Pacific plate subsided, so the hydroplates accelerated downhill, sliding on a layer of lubricating water.</p> <p>Hours later, the massive hydroplates decelerated and crashed; they were crushed, thickened, buckled, and heated in a powerful <i>compression event</i>.⁷ Overthrusting occurred in some places. Continents took on their present shapes. As mountains buckled upward—all within an hour—air was displaced, causing a great wind. The earth began a slow 34°–57° roll, so the poles shifted. [See pages 130–135, and 486–487.]</p>
<p>150th – 371st Day: Passengers stayed on Ark.</p>	<p>Recovery Phase: Hostile environment began: earthquakes, melting in the inner earth, Ice Age, continental shifting, and Ring of Fire (flood basalts and volcanoes); ocean trenches and methane hydrates formed; water drained; vegetation reestablished. Lower sea level facilitated land migration and formed tablemounts and submarine canyons. Plateaus were lifted hydraulically. Breaching of natural dams carved large continental canyons, such as the Grand Canyon.</p>
<p>371st Day: Ark was off-loaded. (Gen 8:15–19)</p>	
<p>371st Day to the present. Earth divided in Peleg’s day. [See page 515 and Endnote 16 on page 499.]</p>	

The flood was initiated by God because of man's sin. We may never know the precise event that God used (or allowed) to physically trigger the flood.⁸ However, once it started, other events must have occurred whose consequences, or "wreckage," we can still see. Examples include the jigsaw fit of the continents; rapid burial and preservation of trillions upon trillions of fossils in layered rocks; marine fossils on every major mountain range; crumpled mountains; coal, oil, and methane deposits; frozen mammoths; strange features on the ocean floor; earthquakes and volcanic eruptions; the Ring of Fire and earth's core; gouged out canyons; chondrules, comets, asteroids, and meteorites; earth's radioactivity; and hundreds of other consequences. One can place these events in a cause-and-effect sequence that (1) conforms to scientific laws, (2) explains details of these observations, and (3) provides a greater understanding of this global cataclysm. That is the purpose of the hydroplate theory.

The following verses speak of events similar to those described in the hydroplate theory. Taken collectively, they provide support for the statements above them in bold. Some passages may be metaphors referring to ancient demonstrations of God's power.

1. Large quantities of subterranean water existed in the ancient past.

- ◆ Psalm 24:2. ... *He has founded it [the earth] upon the seas ...*
- ◆ Psalm 33:7. ... *He gathers the waters of the sea together as a heap; He lays up the deeps in storehouses ...* (A storehouse is a closed container that preserves something you *may use* later. God used that water when it was brought forth as a flood. Many storehouses, or interconnected chambers, held the subterranean water.)
- ◆ Psalm 104:3. *He lays the beams of His upper chambers in the waters ...*⁹ [Pillars were formed.⁸]
- ◆ Psalm 136:6. ... [He] *spread out the earth above the waters ...*
- ◆ II Peter 3:5. ... *the earth was formed out of water and by water ...*⁸

2. These subterranean waters, under extreme pressure, burst forth, bringing on the flood.¹⁰

- ◆ Genesis 7:11–12. ... *the fountains of the great deep burst open,¹¹ and the floodgates⁴ of the sky were opened. And rain fell ...*¹²
- ◆ Job 38:8–11. ... *who enclosed the sea with doors, when bursting forth, it went out from the womb; when I made a cloud its garment ...*
- ◆ Psalm 18:15. ... *the channels of water appeared, and the foundations of the world were laid bare ...*
- ◆ Proverbs 3:20. ... *the deeps were broken up and the skies dripped dew ...*

3. Some supercritical subterranean water is still jetting up

from beneath the ocean floor. [See Figure 56 on page 125.]

- ◆ Job 38:16a. *Have you entered into the springs of the sea?*

4. The deepest recesses on the ocean floor are trenches. [See Figure 83 on page 152.]

- ◆ Job 38:16b. *Or have you walked in the recesses of the deep?*

5. A massive hailstorm occurred.

- ◆ Exodus 9:18, 24. ... *I will send a very heavy hail, such as has not been seen in Egypt from the day it was founded until now. ... So there was hail, and fire flashing continually in the midst of the hail, very severe, such as had not been in all the land of Egypt since it became a nation.* [This could mean that an even larger hail and lightning storm than the one God inflicted on Pharaoh occurred *before* Egypt became a nation. If so, that more powerful hail and lightning storm was presumably during the flood.]

6. After 40 days and 40 nights, the avalanche of rain (geshem⁴ rain) stopped, because the layer of water rising on the earth reached a tipping point and suddenly poured into and suppressed the high jetting of the fountains of the great deep. [See "The Water Prevailed" on page 491.] However, high-pressure, subterranean waters continued to gush out and add to the rising floodwater. On the 150th day, floodwaters covered all pre-flood mountains. Then, the floodgates were closed by the hydroplates slowly settling onto the chamber floor, pinching shut the outward flowing water.

- ◆ Genesis 7:12. *And the [geshem⁴] rain fell upon the earth for forty days and forty nights.*
- ◆ Genesis 7:18–19, 24. ... *the water prevailed and increased greatly ... so all the high mountains everywhere under the heavens were covered. ... and the waters prevailed for one hundred and fifty days.*
- ◆ Genesis 8:2. *Also, the fountains of the deep and the floodgates of the sky were closed, and the rain from the sky was restrained.*

7. During the compression event, the continents crushed, buckled, and thickened and mountains dramatically rose—in less than an hour.⁷ Then the floodwaters receded.

- ◆ Psalm 104:6b–9. ... *the waters were standing above the mountains. At Thy rebuke they fled; at the sound of Thy thunder they hurried away. The mountains rose; the valleys sank down to the place which Thou didst establish for them. Thou didst set a boundary that they [the waters] may not pass over; that they may not return to cover the earth.*¹³
- ◆ Proverbs 8:22–29 contains a possible description of some very early events in earth's history.

8. Before the flood, the Earth probably had a 360-day year and a 30-day lunar month. As Genesis 1:14–16a states, the Sun and Moon were created as "very good" time keepers. The 150th day of the flood was exactly 5 months

after the fountains of the great deep broke loose. [See Genesis 7:11, 7:24, and 8:4.] Five 30-day months would be 150 days; twelve 30-day months would be 360 days. The flood may have altered a 30-day lunar orbit. [See Endnote 35 on page 185, Figure 175 on page 311, and “Does Subduction Really Occur?” on page 593.]

9. The flood was a catastrophic event that involved far more than falling rain. The earth shook violently and was accompanied by continuous thunder; the erupting fountains of the great deep darkened the sky; some launched rocks fell back to earth as glowing hailstones; powerful electrical activity (generated by the fluttering crust and the piezoelectric effect) was unleashed, and torrents of water emerged from below.

- ◆ Psalm 18:7–15. *Then the earth shook and quaked; and the foundations of the mountains were trembling and were shaken, ... He made darkness His hiding place, His canopy around Him, darkness of waters, thick clouds of the skies ... The Lord also thundered in the heavens, and the Most High uttered His voice, hailstones and coals of fire ... lightning flashes in abundance ... Then the channels of water appeared, and the foundations of the world were laid bare ...*

10. The Book of Jasher.¹⁴ Although not inspired scripture, *The Book of Jasher* (which means “*The Book of the Upright*”) is mentioned in Joshua 10:13 and II Samuel 1:18. Jasher 6:11 vividly describes the beginning of the flood.

And on that day, the Lord caused the whole earth to shake, and the sun darkened, and the foundations of the world raged, and the whole earth was moved violently, and the lightning flashed, and the thunder roared, and all the fountains in the earth were broken up, such as was not known to the inhabitants before; and God did this mighty act, in order to terrify the sons of men that, there might be no more evil upon earth.

No original manuscript of *The Book of Jasher* has been located. At least three different books claim to be *The Book of Jasher*. All but one can be dismissed as bogus, based on linguistic and other problems. However, details in *The Book of Jasher*, which contains 91 chapters and was translated from Hebrew in 1625, show that *Jasher* is probably a copy of the book mentioned in Joshua and II Samuel.¹⁵

Jasher conforms historically to the Bible at many points, provides interesting details, and was obviously well known when Joshua and Samuel were written. One also sees a fascinating flow of over 3,000 years of Hebrew and Egyptian history—from creation to the Israelites entry into the Promised Land. Some parts are exaggerations that may have been inserted since the original *Jasher* was written. Wayne Simpson,¹⁴ who provides an extensive analysis of the book, believes it is a detailed record of Abraham’s family compiled by his descendants over many generations, with large sections contributed by Joseph

when he was Vizier of Egypt—second only to Pharaoh. Certainly, *Jasher* is very ancient, at least 2,300 years old.

If you have read “The Origin of Earth’s Radioactivity” on pages 379–433, “*the lightning flashed*” in Jasher 6:11, Exodus 9:24, and Psalm 18:14 will carry special meaning, as will the fluttering crust and pounding pillars with the words “*caused the whole earth to shake*,” and “*the foundations of the world raged*.”

11. Isaiah (Is 24:18–20) uses terminology that likens a future global catastrophe to the destructiveness of the flood.

For the windows above are opened, and the foundations of the earth shake. The earth is broken asunder, The earth is split through, The earth is shaken violently. The earth reels to and fro like a drunkard ...

We know there will not be another global flood (Genesis 9:11), so Isaiah is not saying the future destruction will be by floodwaters. But there are other similarities, which numerous commentators have described as an echo of the flood. Keil and Delitzsch, in their highly respected Bible commentary, attribute the flood terminology to Isaiah’s purpose in describing this judgment as a direct act of God that totally destroys the earth. They also point out that the “*foundations of the earth*” are “the internal supports upon which the visible crust of the earth rests.”¹⁶ The hydroplate theory calls those supports pillars—the thousands of points where the crust, because of its varying density and thickness, sagged to the floor of the subterranean water chamber. Notice the similarity of Is 24:18–20 with Jasher 6:11 above.

12. The Bible has two well-known predictions that the hydroplate theory helps explain.

Before the flood, water was heating up immediately below the crust. This resulted in a global catastrophe that was predicted in Genesis 6:13 and 6:17. Since the flood, liquid rock (magma) has been heating up in the earth’s core. This will result in a global catastrophe that is remarkably consistent with the predictions in Mt 24:7, Mk 13:8, Lk 21:11, and II Peter 3:7. [See page 181.]

Final Thoughts. If we accept the Bible’s eyewitness accounts of the flood, we should also answer some questions the biblical account raises: Where did enough water come from to cover all the mountains on earth? Where did all that water go afterwards? After the flood, how could animals cross oceans and migrate to every continent on earth? How could such violent rain fall so rapidly at the beginning of the flood but end after 40 days, even though the floodwaters rose and covered all the mountains on the 150th day of the flood? If the flood’s 40 days of rain formed by condensation, that rain should have stopped after a few days, because rain would have removed the condensation nuclei, necessary to form today’s rain. The hydroplate theory answers these questions and others.

The Water Prevailed

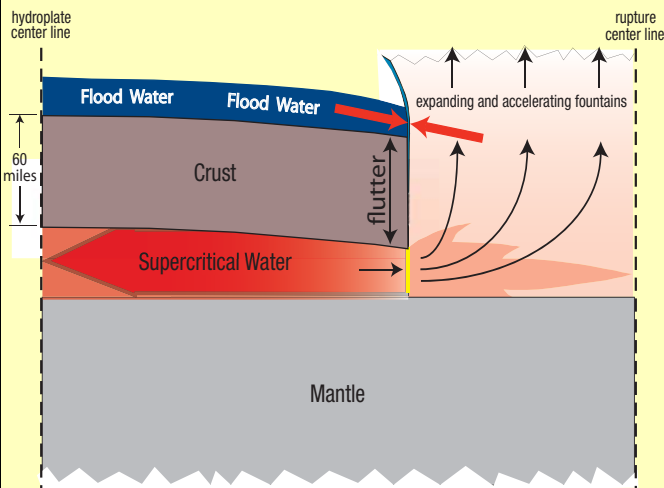

Figure 244: The Tipping Point. (A similar figure and related information are on pages 581–582.) Shown, but not to scale, is a cross section of the earth’s crust and the jetting supercritical water (SCW) hours to weeks after the rupture. The left and right dashed lines are the vertical center lines of a hydroplate and the rupture, respectively. A mirror image of this figure (not shown) would lie to the left and right of each center line. Because of this symmetry, the dashed lines can be thought of as barriers beyond which matter will not flow.

The two red arrows represent opposing forces. The left red arrow represents the force of the floodwaters that tended to pour into the 60-mile-deep chasm and quench (shut off) the fountains. The right arrow represents the high pressure, expanding fountains that pushed the floodwater to the left. Which force prevailed over the other? For about the first 40 days of the flood, the expanding fountains prevailed. Then, gravity and the downward fluttering overcame the weakening fountains. As the floodwaters filled the chasm, the fountains were quickly shut off.

Genesis 7:18–20 and 7:24 state:

*And the water **prevailed** and increased greatly upon the earth; and the ark floated on the surface of the water. And the water **prevailed** more and more upon the earth, so that all the high mountains everywhere under the heavens were covered. The water **prevailed** fifteen cubits higher, and the mountains were covered. ... And the water **prevailed** upon the earth one hundred and fifty days. [emphasis added]*

English translations of the flood account in Genesis 6–9 have lost some powerful, insightful meanings of a few key Hebrew words. Standard Hebrew-English dictionaries have also “missed the boat.” The failure lies primarily in using English words that describe our common experiences, but the flood was the most uncommon event since the creation. This also has contributed to the centuries of confusion and doubt concerning the flood. I am indebted to G. Russell Akridge for explaining this in his 1981 article “The Hebrew Flood Even More Devastating than the English Translation Depicts.”¹⁷ Akridge gained his insights into meanings of the ancient Hebrew from the *Hebrew and Chaldee Lexicon* (HCL) by Wihelm Gesenius.¹⁸

One of these Hebrew words, *gabar*, is translated “prevailed” in most English translations of the above verses. According to HCL, *gabar* carries the idea of *one powerful force overcoming another powerful force*. Therefore, we must ask what powerful forces opposed each other as the floodwaters rose to cover all pre-flood mountains.

Figure 244 shows that the rising floodwaters would have immediately drained into the 60-mile-deep chasm formed by the widening rupture had it not been for the dynamic pressure of the fountains themselves.

At the base of the fountains, the static pressure of the supercritical water (SCW) was a gigantic 62,000 psi. (A large, but unknown, amount of addition pressure was

provided by the nuclear effects explained in “**Vast Energy Generated / Vast Energy Removed**” on page 394.) As each bundle of SCW rose in the fountain, two effects tended to decrease each bundle’s pressure: (1) increasing elevation and (2) increasing velocity. However, for every incremental drop in pressure, two other effects would have instantly restored the pressure: (1) evaporation from the hot, microscopic droplets within the SCW, and (2) the release of electrical energy.¹⁹ High pressures would have existed until only electrically-neutral superheated steam remained far above earth’s surface. [To understand SCW water, see “**Three Common Questions**” on pages 126–127.]

The crust fluttered in the early weeks of the flood at a frequency of about one cycle every 30 minutes. [See pages 197 and 606.] A downward flutter at the sagging²⁰ edge of the rupture tended to send the floodwaters into the 60-mile-deep chasm, weakening the fountains even more. For about the first 40 days of the flood, these powerful inertial and gravitational forces were overcome by the more powerful “prevailing” force of the expanding fountains.

Once the rupture had widened enough and the height of the subterranean chamber had decreased enough, the fountains weakened sufficiently to reach a tipping point. Then, floodwaters on the earth’s surface poured into the chasm, weakening the fountains even more. This sudden collapse produced the tallest (60-miles-high), widest (46,000-miles-wide) waterfalls in earth’s history—one on each side of the rupture. The inpouring would have occurred as the edge of the fluttering plate was in the downward quarter of its 30-minute cycle. Therefore, at each point along the 46,000-mile-long rupture, the fountains were turned off within minutes—although not simultaneously—all on about the 40th day of the flood. Even after the fountains were shut off, vast amounts of water still under the crust continued to escape from the chambers, so the floodwaters steadily rose until the continental-drift phase began on the 150th day of the flood.

Today, some do not believe there was a catastrophic, global flood. They think it was a relatively mild, local event, or avoid discussing it because they believe too many unanswerable questions would be raised that might subject

them to ridicule. The problem for most of us is grasping the flood's almost unimaginable magnitude and power, which is difficult without a close study of the biblical texts and the scientific evidence from many disciplines.

References and Notes

- How quickly? Ten years or less. If the initial temperature in the subterranean water was 0°C—the most conservative temperature (least favorable) for my proposed explanation), it would have taken 10 years for tidal pumping to produce supercritical temperatures and for the preflood hydrodynamic cycle to reach steady state globally. [See [“Tidal Pumping: Two Types”](#) on page 595.] With rivers flowing out of the Garden of Eden from the beginning, as the Bible states, plenty of water was available for humans, animals and plants for those 10 years.
- See [“Three Common Questions”](#) on pages 126–127.]
- This Hebrew word for “deep” is *tehom*, which according to the 1973 *Strong’s Concordance*, means “a surging mass of water, especially from the main sea or the subterranean water supply.” [See *Strong’s Exhaustive Concordance of the Bible* (New York: Abingdon Press, 1973), Hebrew Word 8415.]
- The “floodgate terminology” shows that water fell in a violent and concentrated manner. Imagine the overwhelming force you would feel if you stood under floodgates that suddenly opened—floodgates with 40 days’ worth of water behind them! The word for violent rain, גֶּשֶׁם (transliterated *geshem*), was used instead of the word for normal rain. *Geshem* rain is sometimes accompanied by high winds and huge hailstones that can destroy mortared walls (Ezekiel 13:11–13). Normal rain (*matar* rain) is formed by condensation, a relatively slow process, because heat must be transferred away from condensing droplets. Rain that formed by condensation would not release the sudden, dramatic power suggested by the “floodgate terminology.”
The Hebrew word for “floodgates” is *arubbah* (אַרְבָּעָה). In Isaiah 24:18, the *arubbah*’s opening was associated with the shaking of the foundations of the earth (as the hydroplate theory describes). In Malachi 3:10, II Kings 7:2, and 7:19, *arubbah* is an almost miraculous opening of the sky. In Hosea 13:3, it means “chimney” and describes smoke pouring from a chimney, much like muddy water jetted into the sky in the hydroplate theory.
- See [“Rocket Science”](#) on page 581.
- See [“Why Did the Floodwater Drain So Slowly?”](#) on page 503.
- See Figure 50 on page 117, and [“Could Earth’s Mountain Ranges Form in Less Than an Hour?”](#) pages 486–487.
- See [“What Triggered the Flood?”](#) on pages 469–475.
- Psalm 104:1–4 is a celebration of the first and second creation days. [See C. F. Keil and F. Delitzsch, *Commentary on the Old Testament in Ten Volumes*, Vol. 5 (reprint, Grand Rapids: Eerdmans Publishing Co., 1980), p. 128.]
- Henry Morris, a prolific author and insightful student of the Bible, wrote:
The Bible specifically attributes the Flood to the bursting of the fountains of the great deep and the pouring down of torrential rains from heaven. These two phenomena are sufficient in themselves (in light of related Biblical information, as discussed above) to explain the Flood and all its effects without the necessity of resorting either to supernatural creative miracles or to providentially ordered extraterrestrial interferences of speculative nature.
The breaking up (literally ‘cleaving open’) of the fountains of the great deep is mentioned first and so evidently was the initial action which triggered the rest. These conduits somehow all developed uncontrollable fractures on the same day. For such a remarkable worldwide phenomenon, there must have been a worldwide cause. The most likely cause would seem to have been a rapid buildup and surge of intense pressure throughout the underground system, and this in turn would presumably require a rapid rise in temperature throughout the system.
Henry M. Morris, *The Genesis Record* (San Diego, California: Creation-Life Publishers, 1976), p. 196.
- The same Hebrew word, *baqa* (בָּקַע), is used for “burst open” and “broken up” in Genesis 7:11 and Proverbs 3:20, respectively. *Baqa* describes a violent and complete splitting, sometimes of the earth’s crust (Numbers 16:31, Micah 1:4, Zechariah 14:4). Isaiah 34:15 and 59:5 use *baqa* to describe the breaking of an egg shell by internal pressure as a baby bird exits. This aptly describes events of the hydroplate theory—the globe encircling rupture (or splitting) of earth’s crust by internal pressure. [See Figures 42 and 58 on pages 108 and 125.]
- These events—the bursting open of the fountains of the great deep, opening of the floodgates of the sky, and falling rain—are in the cause-and-effect order of the hydroplate theory. This is also the order in Genesis 8:2 and Proverbs 3:20.
- God promised to never send another global flood (Genesis 9:15). Psalm 104:6b–9 tells why water would “*not return to cover the earth.*” The mountains rose, and the valleys sank down, so a boundary was set for the waters.
The hydroplate theory provides further understanding. During the compression event, continents were crushed and thickened; mountains buckled up much higher than preflood mountains. Water drained into the low spots as the land rose out of the water. Imagine the violent sounds—“*the sound of Thy thunder*”—during the compression event. After the hydroplates settled onto the floor of the subterranean chamber, water could no longer be forced up onto the continents. Earth’s surface water ended up in basins—“*a boundary that they*

may not pass over; that they may not return to cover the earth.”
It is now clear why there will never be another global flood.

After the flood, some water remained (1) between the irregularities in the chamber floor and the settling hydroplates, and (2) in cracks in the crushed hydroplates. This trapped water helps explain saltwater under the Tibetan Plateau (explained in Endnote 12 on page 474), and why deep drilling has intersected “hot flowing water” that is too deep to have seeped down from the earth’s surface. [See pages 118 and 135.] Exodus 20:4 may refer to this water.

14. *The Book of Jasher*, translated from Hebrew by *Mordechai Noah in 1840* (Salt Lake City: J. H. Parry & Company, 1887).

- ◆ Wayne Simpson, *The Authentic Annals of the Early Hebrews* (Kearney, Nebraska: Lightcatcher Books, 2003).

Simpson’s book contains *The Book of Jasher* plus informative analyses of its accuracies and inaccuracies.

15. For details, see “The Clear Truth about The Book of Jasher at www.lulu.com/items/volume_67/8173000/8173208/1/print/jasher.pdf.

16. C. F. Keil and F. Delitzsch, *Commentary on the Old Testament in Ten Volumes*, Vol. 7 (reprint, Grand Rapids: Eerdmans Publishing Co., 1981), p. 432.
17. G. Russell Akridge, “The Hebrew Flood Even More Devastating than the English Translation Depicts.” *Creation Research Society Quarterly*, Vol. 17, March 1981, pp. 209–213.
18. Wihelm Gesenius, translation by Samuel Tregelles, *Hebrew and Chaldee Lexicon* (Grand Rapids: Eerdmans Publishing Co., 1967).
19. In the centuries before the flood, tidal pumping steadily increased temperatures in the subterranean chamber, so water molecules became increasingly ionized. More and more water molecules separated into H⁺ and OH⁻ ions—electrical charges that later recombined (slammed together) in the cooling fountains and released heat that, in turn, increased pressure. [See Endnote 52 on page 144.]
20. Since the pressure of the flow under each hydroplate drops in the downstream direction, the edges of the hydroplates must sag (concave downward), as shown in Figure 244.

What about the Dinosaurs?

This frequent question, asked in just this way, implies many questions related to dinosaurs, a word meaning “terrible lizards.” When did they live? What killed the dinosaurs? What were they like? What does the Bible say about them? Could the Ark have held so many large animals? Why are their bones and fossils found inside Antarctica and the Arctic Circle—unlivable places, too cold and lacking food?

There were about 500 different types of dinosaurs. Most were large; some even gigantic. One adult dinosaur was as tall as a five-story building. However, some adults were small, about the size of a chicken. [See page 464.] Most evolutionists now say that birds are dinosaurs.

Many questions will be answered if we focus on one question, “When did they live?” Two quite different answers are usually given. Evolutionists say that dinosaurs lived, died, and became extinct at least 60-million years before man evolved. Others believe God created all living things during the creation week, so man and dinosaurs lived at the same time. If we look at the evidence, sorting out these two very different answers should be easy.

Did dinosaurs become extinct at least 60-million years before man evolved? Almost all textbooks that address the subject say they did. Movies and television vividly portray this. One hears it even at Disney World and other amusement parks. Some will say that every educated person believes this. We frequently hear stories that begin with impressive-sounding phrases such as, “Two hundred million years ago, when dinosaurs ruled the earth, ...” But none of this is evidence; some of it is an appeal to authority. Evidence must be observable and verifiable.

Did man and dinosaurs live at the same time? Scientists in the former Soviet Union have reported a layer of rock containing more than 2,000 dinosaur footprints alongside tracks “resembling human footprints.”¹ Obviously, both types of footprints were made in mud or sand that later hardened into rock. If some are human footprints, then man and dinosaurs lived at the same time. Similar discoveries have been made in Arizona.² Were it not for the theory of evolution, few would doubt that these were human footprints.

Soft dinosaur tissue has now been recovered from several dinosaurs: three tyrannosaurs (*T. Rex*) and one hadrosaur. It is ridiculous to believe that soft tissue can be preserved for 60,000,000 years, but it could be preserved since the flood, about 5,000 years ago. [For details see “**Old DNA, Bacteria, Proteins, and Soft Tissue?**” on page 38.]

The Book of Job is one of the oldest books ever written. In it, God tells of His greatness as Creator and describes an animal, called Behemoth, as follows:

*Behold now, Behemoth, which I made as well as you;
He eats grass like an ox. Behold now, his strength in his loins,
And his power in the muscles of his belly.
He bends his tail like a cedar; The sinews of his thighs are knit together.
His bones are tubes of bronze; His limbs are like bars of iron.* (Job 40:15–18)

Marginal notes in many Bibles speculate that Behemoth was probably an elephant or a hippopotamus, but those animals have tails like ropes. Behemoth had a “tail like a cedar.” Any animal with a tail as huge and strong as a cedar tree is probably a dinosaur. Also, Job 40:19–24 says this giant, difficult-to-capture animal was not alarmed by



Figure 245: Probably Not a Plesiosaur. This 32-foot-long “monster,” caught by a Japanese fishing ship off the coast of New Zealand in 1977, was unfortunately thrown overboard soon after this picture was taken. The animal made front-page news for weeks in Japan. Several Japanese scientists felt that it was a plesiosaur, and a Japanese postage stamp seemed to commemorate the discovery of the first modern plesiosaur. In the 6th edition (1995) of this book, this animal was incorrectly labeled as a “possible plesiosaur.” Later, after reading English translations of opinions of other Japanese scientists and seeing similar pictures of decaying basking sharks, it is more likely that this was a large basking shark.³ Decay patterns near the shark’s head give the appearance of a neck. My apologies for the error.

a raging river. If the writer of Job knew of a dinosaur, then the evolution position is wrong, and man saw dinosaurs.

The next chapter of Job describes another huge, fierce animal, a sea monster named Leviathan. It was not a whale or crocodile, because the Hebrew language had other words to describe such animals. Leviathan may be a plesiosaur (PLEE-see-uh-sore), a large seagoing reptile that evolutionists say became extinct 60-million years before man evolved. Other ancient writing describe Behemoth and Leviathan.⁴

For the past three centuries, reports have come from the Congo in western Africa that dinosaurs exist in remote swamps. These eyewitness stories are often from educated people who can quickly describe dinosaurs. Two expeditions to the Congo, led by biologist Dr. Roy Mackal of the University of Chicago, never saw dinosaurs, but interviewed many of these witnesses and concluded that their reports were about dinosaurs and were apparently true.⁵ If any of these accounts are correct, man and dinosaurs were contemporaries.

References and Notes

1. Alexander Romashko, “Tracking Dinosaurs,” *Moscow News*, No. 24, 1983, p. 10.
2. Paul O. Rosnau et al., “Are Human and Mammal Tracks Found Together with the Tracks of Dinosaurs in the Kayenta of Arizona?” Parts I and II, *Creation Research Society Quarterly*; Vol. 26, September 1989, pp. 41–48 and December 1989, pp. 77–98.

Consider the many dragon legends. Most ancient cultures have stories or artwork of dragons that strongly resemble dinosaurs.⁶ *The World Book Encyclopedia* states that:

*The dragons of legend are strangely like actual creatures that have lived in the past. They are much like the great reptiles [dinosaurs] which inhabited the earth long before man is supposed to have appeared on earth. Dragons were generally evil and destructive. Every country had them in its mythology.*⁷

The simplest and most obvious explanation for so many common descriptions of dragons from around the world is that man once knew the dinosaurs.

What caused the extinction of dinosaurs? Primarily, the flood. Because dinosaur bones are found among other fossils, dinosaurs must have been living when the flood began. Dozens of other dinosaur extinction theories exist, but all have recognized problems. [See pages 122–123.] Most of the food chain was buried in the flood. Therefore, many large dinosaurs that survived the flood probably had difficulty feeding themselves and became extinct.

One of the least acknowledged dinosaur mysteries is the discovery of their fossils and bones inside the Arctic Circle and in Antarctica⁸—places where they shouldn’t have been able to live. That mystery is solved when one understands why the earth slowly rolled 34°–57° after the flood. [See “Earth Roll” on page 136.]

Were dinosaurs on the Ark? Yes. God told Noah to put representatives of every kind of land animal on the Ark. (Some dinosaurs were semiaquatic and could have survived outside the Ark.) But why put adult dinosaurs on the Ark? Young dinosaurs would take up less room, eat less, and be easier to manage. Animals were on board so they could reproduce after the flood and repopulate the earth. Young dinosaurs would have more potential for reproduction than old dinosaurs.

Bones of certain dinosaurs show annual growth rings, as trees do. Those dinosaurs, early in life and late in life, grew very slowly. During mid-life, they had large growth spurts.⁹ Therefore, their juveniles, during the year they were on the Ark, probably weighed less than 60 pounds. (A 2-year-old *T. Rex* weighed 66 pounds. The largest known *T. Rex* lived to the age of 28 years.¹⁰ Dinosaurs did not become large because they lived long lives.)

- ◆ Before 1986, the film, *Footprints in Stone*, and John Morris’ book, *Tracking Those Incredible Dinosaurs*, popularized the idea that dinosaur tracks and human tracks were together along the banks of the Paluxy River, near Glen Rose, Texas. Later, it was learned that a particular dinosaur made those tracks when it was walking uphill. Because of these errors, the film and book are no longer distributed. A few creationists still claim that some of these manlike tracks were made by

humans. I believe that the Paluxy tracks should be studied more and many questions satisfactorily answered before claiming human tracks are along the Paluxy River.

- ◆ In Uzbekistan, 86 consecutive horse hoofprints were found beside supposedly 90–100-million-year-old dinosaur tracks. Evolutionists have almost as much difficulty believing that horses and dinosaurs lived together as they do man and dinosaurs. Horses allegedly did not evolve until many millions of years after the dinosaurs became extinct. [See Y. Kruzhillin and V. Ovcharov, “A Horse from the Dinosaur Epoch?” *Moskovskaya Pravda (Moscow Truth)*, 5 February 1984.]
- 3. Glen J. Kuban, “Sea-Monster or Shark? An Analysis of a Supposed Plesiosaur Carcass Netted in 1977,” *Reports of the National Center for Science Education*, Vol. 17, May/June 1997, pp. 16–19, 22–28.
- ◆ Pierre G. Jerlström, “Live Plesiosaurs: Weighing the Evidence,” *Creation Ex Nihilo Technical Journal*, Vol. 12, No. 3, 1998, pp. 339–346.
- ◆ Pierre G. Jerlström and Bev Elliott, “Letting Rotting Sharks Lie,” *Creation Ex Nihilo Technical Journal*, Vol. 13, No. 2, 1999, pp. 83–87.
- 4. Psalms 74:14 and 104:26, and Isaiah 27:1 mention Leviathan. Both Leviathan and Behemoth are described in the apocryphal book II Esdras. Both were given separate territories because of their large size.

Then you set apart two creatures: one you called Behemoth and the other Leviathan. You put them in

separate places, for the seventh part where the water was collected was not big enough to hold them both. A part of the land which was made dry on the third day you gave to Behemoth as his territory, a country of a thousand hills. II Esdras 6:49–52

5. Roy P. Mackal, *A Living Dinosaur?* (New York: E. J. Brill, 1987).
- ◆ “Living Dinosaurs?” *Science* 80, November 1980, pp. 6–7.
- ◆ Jamie James, “Bigfoot or Bust,” *Discover*, March 1988, pp. 44–53.
6. Lorella Rouster, “The Footprints of Dragons,” *Creation Social Science and Humanities Quarterly*, Fall 1978, pp. 23–28.
7. Knox Wilson, “Dragon,” *The World Book Encyclopedia*, Vol. 5, 1973, p. 265.
8. “First record of a sauropod dinosaur in Antarctica suggests more widespread distribution of this species than previously thought. ... Other important dinosaur discoveries have been made in Antarctica in the last two decades—principally in the James Ross Basin.” Joan Robinson, “Plant-Eating Dinosaur Discovered in Antarctica,” 19 December 2011, *Naturwissenschaften*, www.springer.com/about+springer/media/springer+select?SGWID=0-11001-6-1321221-0.
9. Gregory M. Erickson et al., “Gigantism and Comparative Life-History Parameters of Tyrannosaurid Dinosaurs,” *Nature*, Vol. 430, 12 August 2004, pp. 772–775.
10. *Ibid.*, p. 773.

Why Is Global Warming Occurring? What Can Be Done about It?

Global warming—an emotionally charged social, political, economic, and ecological issue—is occurring. Most who conclude that man is the primary cause of global warming also believe the Earth is billions of years old, and are alarmed that man is ruining a billion-year-old Earth in just a few decades. Nevertheless, global warming is extremely serious.

We frequently hear that humans are raising global temperatures by producing too much carbon dioxide (CO₂), a greenhouse gas. That is only part of the problem.¹ Many other factors are involved. Increases in atmospheric CO₂ began recently—at the start of the industrial revolution (in about 1750). Global warming actually began at the end of the ice age—thousands of years earlier! Therefore, man-made CO₂ is not the main cause of global warming. Besides, water vapor in the atmosphere is a more potent and abundant greenhouse gas. The amount of water vapor, and its warming effects, increase as temperatures rise.

If not reversed, global warming will damage world economies, raise sea levels,² and increasingly produce extreme weather (tornadoes, hurricanes, fires, and local floods). Poorer countries will suffer the most. Thousands of researchers with conflicting solutions to the problem are competing for funds.

However, before trillions of dollars are spent trying to stop global warming, all its causes should be clearly understood.

The Sun’s slightly variable output accounts for some of earth’s temperature fluctuations, but the dangerous warming trend, seen over centuries, will probably continue for surprising reasons. We should first understand why the Earth has so much ice—7 million cubic miles, of which 88% is in Antarctica and 10% in Greenland. If all that ice melts, sea level will rise at least 200 feet with disastrous results.²

Just a 10-meter (33-foot) rise in sea level would displace 10% of the world’s population and submerge New Orleans, New York City, London, much of Florida, and small islands. Large parts of North America’s east coast, northern Europe, Bangladesh, Siberia, and China, would also be flooded. A 200-foot rise in sea level would displace 20% of the world’s population.³

The global flood produced the unique conditions that for over a century caused the Ice Age: *cold continents and warm oceans*. [See pages 111–151.] Crashing hydroplates at the end of the flood crushed and thickened continents and buckled up Earth’s major mountains, making continents temporarily higher and, consequently colder than they are today. Also,

after the flood, oceans were warmer than today, primarily because so much magma erupted onto the floor of the Pacific Ocean. Even today, extremely hot supercritical water, jetting up from under the ocean floor, is warming the oceans. [See Figure 56 on page 125.] Warm oceans produced extensive evaporation and precipitation, which on the cold continents resulted in extreme snowfall rates that built up glaciers. Heavy cloud cover, dust and light-reflecting aerosols from volcanoes, also a consequence of the flood, further cooled the continents.

Large temperature differences between cold continents and warm oceans generated powerful wind systems that quickly carried moist air up and over continents where much of the water vapor cooled, condensed, and fell as snow. Each winter's glacial advances were followed by summer's glacial retreats. These yearly cycles left marks that some mistakenly associate with multiple ice ages (4–30 ice ages, depending on location).

For a few centuries after the flood, oceans gradually cooled and the continents and their mountains, that thickened during the compression event, slowly sank into the mantle. Both changes steadily reduced the heavy snowfall toward today's rates. Eventually, ice depths peaked. With decreasing snow cover, less of the Sun's radiation was reflected off ice sheets and back into space.⁴ Therefore, the Sun has been increasingly warming the Earth and melting ice. This **first positive-feedback** cycle will continue unless steps are taken to reverse the cycle.

A second consequence of earth's ice melting is rising sea levels which shift mass toward the equator, slightly increasing earth's polar moment of inertia, and slowing earth's spin rate.⁵ (This is one reason clocks on earth are stopped periodically for one second to let the slowing earth catch up.) Therefore, days are becoming slightly longer and warmer on average and nights slightly colder. The net effect of all this is more melting ice and global warming—a **second** positive feedback cycle.

Those who claim that man is the sole cause of global warming have not addressed the key question: *Why did the Earth once have so much ice?* Apart from the worldwide flood, explanations for the Ice Age have fatal scientific problems—something most earth scientists understand. Since the peak of the Ice Age, melting ice has raised sea level about 400 feet;⁶ man did not cause *that* rise. Without some major change, sea level will rise at least 10 inches in the next 100 years and almost 200 feet in the next few thousand years.⁷ This steady rise will be apparent to all in a few decades.

Yes, atmospheric CO₂ is increasing, but much of the increase is due to warming oceans, which then release some of the huge amounts of CO₂ dissolved in them. That, in turn, increases warming—a **third positive-feedback** cycle and more global warming. (Oceans contain 50 times more CO₂ than the atmosphere!) Simply stated, *CO₂ increases warm the oceans which then produce even more CO₂ increases.*

Warming oceans produced a **fourth** positive feedback cycle by pumping more moisture into the atmosphere. Since water vapor is the most abundant and potent greenhouse gas, that additional water vapor warms the atmosphere which then produces more water vapor.

Forest fires produce CO₂ directly and heat the atmosphere, which then makes forest fires more likely—a **fifth** positive feedback cycle. As the Earth warms, decay processes within the soil increase, and release more CO₂—a **sixth** positive feedback cycle.

What Can Be Done? If the earth can begin to cool, all six positive feedback cycles and global warming will reverse. Many are proposing geoengineering: massive, deliberate interventions in Earth's natural systems to counteract global warming. Those schemes would probably pollute the biosphere and risk other unintended consequences.

Before the flood, there were no major ice sheets, so losing glaciers is not the problem. Earth's pre-flood vegetation was lush, as evidenced by today's abundant coal, oil, and methane deposits. But even without major ice sheets to cool the pre-flood earth, that lush vegetation compensated and made Earth the comfortable habitat God intended. We can move toward those conditions safely by merely **reestablishing and conserving, to the extent possible, earth's forests.**⁸ Within a few decades, reforestation and reducing deforestation would sequester considerable carbon rather than letting it overheat the Earth. Cooling oceans would no longer rise or release their dissolved CO₂.⁹ Annual damage from storms will steadily decrease from the current few hundred billion dollars each year.

Currently, we are losing 25 million acres of forests a year, but plenty of fertile land is available for planting new forests.¹⁰ Yes, conserving forests and reforestation will be expensive, but far less than the billions of dollars of storm damage each year—not to mention the loss of lives in storms, fires, and hurricanes. Suicide rates have also been shown to increase with increases in temperature.¹¹

Photosynthesis. In summary, the key is photosynthesis, which uses the sun's energy to split water into useful hydrogen and oxygen rather than letting that solar energy heat the earth. Today, photosynthesis on earth absorbs three times the energy generated by human civilization.¹²

So, by increasing photosynthesis on earth by one-third, as much *additional* energy will be absorbed by plants as is released by all human activity. Global warming will end, and the four harmful positive feedback cycles mentioned above will reverse: (1) glaciers will stabilize, (2) oceans will stop rising, (3) our atmosphere's main greenhouse gases (CO₂ and water vapor) will steadily decline, and (4) forest fires costing billions of dollars each year will diminish. We must begin immediately.

Those who express opinions on the cause of global warming usually look at its effects today and assume its cause—without considering pre-flood conditions. The hydroplate explanation, which accounts for many

Figure 246. Ancient Map Shows that Antarctic Snow Accumulated Recently. In 1929, this amazing map was discovered in an old palace in Constantinople (Istanbul), Turkey. The map, drawn on gazelle skin, was signed in 1513 by Turkish Admiral Piri Re'is (Pear-ee-RYE-us). The Admiral wrote on the map that it was based on 20 older maps, some dating back to the 4th Century B.C. and one used by Christopher Columbus. The Piri Re'is map shows, with amazing accuracy for the 16th Century, parts of Africa, Europe, the Americas, and Antarctica. Surprisingly, details show that Piri Re'is must have had a source map that was drawn *before snow was deep enough to cover the rugged Antarctic coastline*. Forgery can be ruled out, because the shapes of those ice-covered coastlines were revealed in 1949 by seismic techniques for penetrating deep ice.

The Atlantic Ocean runs down the center of the map. (Disregard the symbols and focus on coastlines.) Notice at the upper right of the map the bulge of Africa and the Iberian Peninsula (today's Portugal and Spain). Next, locate a "skinny" South America. While some scales on the map are distorted and some marginal notes are incorrect, the shapes of the above continents are unmistakable. Finally, in the extreme south is part of the Antarctic coast called Queen Maud Land. Today, glaciers extend far beyond, and hide that irregular coastline. The U.S. Library of Congress and other leading libraries possess copies of the Piri Re'is map.

Charles Hapgood¹³ gives many details of the Piri Re'is and other old maps that show a relatively ice-free Antarctica: Oronteus Finaeus, 1531; Hadju Ahmed, 1559; and Mercator, 1569. These medieval maps, copied 2–3 centuries before 1819 (when textbooks incorrectly say Antarctica was discovered) were probably based on much earlier source maps. All these medieval maps also show much lower sea levels before the Ice Age.¹⁴ (The hydroplate theory explains why the flood produced lowered sea levels and the Ice Age.) The maps provide additional information on Antarctica's mountain ranges, plateaus, bays, coastal islands, and former rivers—which today are under about a mile of ice. Obviously, the Antarctic ice cap grew rapidly and recently¹⁵ as humans were exploring the earth.¹⁶ The ice cap did not grow, as taught for the last century, over millions of years or before man allegedly evolved.



other features of the earth and solar system, makes a more comprehensive understanding of global warming, not just from effect back to cause, but also from cause directly to effect. We can have greater confidence in our

conclusion when, after considering all the data, including the Ice Age and its causes, the issue is seen identically in both directions: cause-to-effect and effect-to-cause.

References and Notes

1. Current increases in atmospheric carbon dioxide (CO₂) are trivial compared to the amount spilled out during the flood. [See "The Origin of Limestone" on pages 260–266.] That release helped reestablish Earth's forests that the flood destroyed and buried. CO₂ is food for plants and provides almost every carbon atom in every living thing.
Experiments conducted by the U.S. Department of Agriculture have shown that if the atmosphere's CO₂ is increased by a given percentage, plant growth increases by an even greater percentage. [See Sherwood B. Idso, *CO₂-Climate Dialogue* (Tempe, Arizona: Laboratory of Climatology, 1987).] Certainly, increases in atmospheric CO₂ have negative consequences, but the above experiments show positive aspects as well.
Doubling of atmospheric CO₂ is *estimated* to increase atmospheric temperatures by about 2.3° C. [See Piers
- Forster, "Half a Century of Robust Climate Models," *Nature*, Vol. 545, 18 May 2017, p. 296.
2. Sea levels rise as oceans warm and thermally expand, or if ice above sea level melts, but sea level drops slightly if ice resting on the sea bottom melts. If *floating* ice melts, water levels do not change.
3. Gordon McGranahan et al., "The Rising Tide: Assessing the Risks of Climate Change and Human Settlements in Low Elevation Coastal Zones," *Environment & Urbanization*, Vol. 19, April 2007.]
4. Dry snow reflects 70–90% of the Sun's radiation; open water reflects only 7–10%.
5. "Researchers have confirmed that rising sea levels caused by melting glaciers are slowing Earth's rotation." Philip Campbell, "Rising Sea Levels Alter Earth's Spin," *Nature*, Vol. 528,

Antarctic Lakes

Historical evidence, described in Figure 246, also shows that snow depths on Antarctica increased recently and rapidly. As they did, lake surfaces froze, and supported snow that covered and insulated the water below from the cold Antarctic air. Antarctica has almost 400 such ice-and-snow-covered lakes.

Lake Vostok, Antarctica's largest and deepest unfrozen subsurface lake, has the volume of Lake Michigan.¹⁷ DNA recovered 2 miles below earth's surface—but directly above the lake's liquid water—shows that thousands of diverse organisms, not native to Antarctica, once lived in the lake. Most DNA was from bacteria, but some were from more complex life forms.¹⁸

*The real surprise was [the DNA] sequences indicating larger organisms like clams and jellyfish. Strangest of all were genetic signatures resembling parasites or symbiotic partners of large aquatic organisms: a rainbow trout, intestinal bacterium, a sponge symbiont, a lobster gut bacterium.*¹⁹

Because DNA degrades rapidly, thousands of organisms must have lived recently in Lake Vostok. A few were complex organisms, “like clams and jellyfish.” Today, they can't live in Antarctica. (The outpost above Lake Vostok “holds the record for the lowest naturally occurring temperature ever observed on earth.”¹⁹) Besides, Lake Vostok is permanently dark; without photosynthesis, what would those animals eat? How could Antarctica have one or, more surprisingly, almost 400 unfrozen lakes buried under snow and ice—a “preposterous”²⁰ discovery made in the 1990s?

Two basic questions must first be answered:

- ◆ How could 400 lakes form in Antarctica?
- ◆ After many years, why would even one Antarctic lake still be unfrozen?

The flood provides the obvious answer to the first question. When the floodwaters drained into the newly formed ocean basins, every continental basin, including those on Antarctica, were left full of water—some with warm, salty water—and clams, jellyfish, and their food. Therefore, Antarctica had lakes right after the flood. Also, recall that the Earth rolled 34°–57° in the centuries after the flood, so Antarctica was at a temperate latitude immediately after the flood. [See “**Earth Roll**” on page 136.]

Those who deny a global flood must find a way to warm Antarctica enough to create lakes. According to the plate tectonic theory, Antarctica has always been at the South Pole, so proponents of that theory cannot claim that Antarctica somehow drifted in from warm latitudes. Nor did volcanic activity provide the necessary heat, because Antarctica has few volcanoes, and most are not near those lakes.

Once a thin sheet of ice forms on a lake in Antarctica, a “race” begins between ice growing downward, and snow building upward. Either the lake will become a solid block of ice, or the snow on top of the lake will become deep enough to insulate the lake and keep it from freezing. Each year, the ice will grow downward and thicken, but at a decreasing rate. Simultaneously, snow will build up above the lake. If the snow's thickness reaches about 2,000 feet before the downward growing ice touches the lake bottom, the lake will be insulated enough to prevent complete freezing by holding enough of the geothermal heat coming up through the floor of the lake.

Of course, the annual snowfall, the average air temperature, and the lake's initial depth and salt content will determine the winner of that race. Today, Antarctica has less than 2 inches of precipitation each year, and the average air temperature is 20°F (-6.7°C) in the summer and -30°F (-34.4°C) in the winter. Under today's conditions, the ice should win that race on Antarctica, especially if the lake is shallow. However, if the lake is deep or salty, snow has a better chance of winning.

The second question is answered when one realizes that for centuries after the flood, snowfall rates were orders of magnitude greater than today, and many postflood lakes were salty *and* deep. The more a lake freezes, the greater the salt concentration in the remaining liquid, so its freezing temperature drops. Ice growth rates would quickly approach zero. Snow would win. One extensively studied subsurface lake in Antarctica, Lake Vida, has seven times the salt concentration of our oceans!²¹

Because Antarctica has so many subsurface lakes, conditions must have been favorable for liquid water to collect on Antarctica and form lakes. This alone suggests that there was a global flood followed by extreme rates of snowfall—the Ice Age. Traces of life in Lake Vostok reinforce both this conclusion and a recent flood. Ask anyone who rejects a global flood why 400 unfrozen lakes lie up to several miles below the surface of Antarctica.

17 December 2015, p. 310.

6. Estimates of the volume of ice on Earth at the peak of the Ice Age are known, so one can approximate how far sea level was lowered at the peak of the ice Age. [For details, see Richard Foster Flint, *Glacial and Quaternary Geology* (New York: John Wiley and Sons, Inc., 1971), pp. 84, 315–342.]
7. Some experts are predicting sea level rises of 10–40 inches (28–97 centimeters) by 2100, and about 1 foot

each subsequent century. [See Nicola Jones, “Rising Tide,” *Nature*, Vol. 501, 19 September 2013, pp. 300–302.]

8. “Forests’ power to store carbon is staggering: one tree can store an average of about 48 pounds in one year.” ... “the most powerful and cost-efficient carbon capture technology in the world.” Han de Groot, “A Low-Tech Climate Fix,” *Scientific American*, April 2019, p. 7.
9. Lucas C. R. Silva, “Carbon Sequestration Beyond Tree Longevity,” *Science*, Vol. 355, 17 March 2017, p. 1141.

10. Doug Boucher, "Science for a Healthy Planet and Safer World," Union of Concerned Scientists, <http://www.ucsusa.org/publications/ask/2012/reforestation>. Last accessed 19 September 2017.
11. Magdalena Skipper, "Suicide Rate Tracks Warming," *Nature*, Vol. 560, 2 August 2018, p. 9.
12. "Today, the average rate of energy capture by photosynthesis globally is approximately 130 terawatts, which is about three times the current power consumption of human civilization." <https://en.wikipedia.org/wiki/Photosynthesis>, Last accessed 19 September 2017.
13. Charles H. Hapgood, *Maps of the Ancient Sea Kings* (New York: Chilton Books, 1966; reprint, Kempton, Illinois: Adventures Unlimited Press, 1996).

On 6 July 1960, the commander of the 8th Reconnaissance Technical Squadron, U.S. Air Force, wrote the following letter to Charles Hapgood. [Ibid., p. 243.]

Dear Professor Hapgood:

Your request for evaluation of certain unusual features of the Piri Reis World Map of 1513 by this organization has been reviewed.

The claim that the lower part of the map portrays the Princess Martha Coast of Queen Maud Land Antarctica, and the Palmer Peninsula is reasonable. We find this is the most logical and in all probability the correct interpretation of the map.

The geographical detail shown in the lower part of the map agrees very remarkably with the results of the seismic profile made across the top of the ice cap by the Swedish-British-Norwegian Antarctic Expedition of 1949. This indicates the coastline had been mapped before it was covered by the ice cap.

The ice cap in the region is now about a mile thick. We have no idea how the data on this map can be reconciled with the supposed state of geographical knowledge in 1513.

Lt. Colonel Harold Z. Ohlmeyer

- ◆ "[This map displays] *a knowledge of cartography comparable to what we have today. These people knew the correct size of the earth; they used spherical trigonometry in their mathematical measurements; and they utilized ultra modern cartographical projections.*" Rene Noorbergen, *Secrets of the Lost Races* (New York: The Bobbs-Merrill Co., Inc., 1977), pp. 94–99.
14. Other maps of this period show continents joined, which requires lowered sea levels. [See Gregory C. McIntosh, *The Piri Reis Map of 1513* (Athens, Georgia: University of Georgia Press, 2000), p. 52.] If today's sea level were lowered by only 300 feet, all continents would be joined, except for narrow channels between Australia and Asia and Europe and North America.
 15. Using questionable assumptions, evolutionists claim that the ice sheets began building up at least a million years ago. Why then, have scientists, using corings down through 12,000 feet of Antarctic ice, discovered frozen bacteria—with their cell walls intact—directly above Lake Vostok? Obviously, those bacteria were not frozen millions of years ago.

"Both [scientists] detected hundreds, in some cases thousands, of bacterial cells per milliliter of [12,000-foot-deep] ice. Some of the bacteria had intact membranes, so 'they were alive fairly recently.'" Mariana Gosnell, "The Last Hidden Place on Earth," *Discover*, November 2007, p. 48.
 16. Researcher Bill Cooper discovered, in a few European libraries, ancient genealogies and histories that go back to Noah and his descendants mentioned in Genesis 10. Those records, written before Europe was introduced to Christianity, were often a basis for ancient rulers establishing their authority. Some of these scrupulously preserved genealogies can be "cross verified." They show remarkably rapid migrations and explorations after the flood by our rugged, resourceful ancestors. These histories also describe an ice age. [See Bill Cooper, *After the Flood: The Early Post-Flood History of Europe Traced Back to Noah* (West Sussex, England: New Wine Press, 1995). See also Endnote 5 on page 517.]

Genesis 10, called the "Table of Nations," names the lands that Noah's early descendants (including Noah's great-great-great grandsons) colonized. Some of their names appear to match names in secular history, and many of these distant lands are identifiable today. All this shows travel across continental distances within a few generations of the flood. This implies navigational abilities similar to those who made the source maps used by Piri Re's and other medieval map makers.
 17. Robin E. Bell et al., "Tectonically Controlled Subglacial Lakes on the Flanks of the Gamburtsev Subglacial Mountains, East Antarctica," *Geophysical Research Letters*, Vol. 33, 28 January 2006, pp. L02504–L02507.
 - ◆ Sid Perkins, "Cold and Deep," *Science News*, Vol. 169, 4 February 2006, pp. 69–70.
 18. Yury M. Shtarkman et al., "Subglacial Lake Vostok (Antarctica) Accretion Ice Contains a Diverse Set of Sequences from Aquatic, Marine and Sediment-Inhabiting Bacteria and Eukarya," *PLOS ONE*, 3 July 2013, pp. 1–12.
 - ◆ "Sure enough, [John] Priscu found dead or dormant cells in the dirty Vostok ice—up to 600,000 per cubic inch." Douglas Fox, "Life Under the Ice," *Discover*, July/August 2013, p. 58.
 19. Rachel Ehrenberg, "Life Under Ice," *Science News*, Vol. 184, 7 September 2013, p. 27.
 20. "The idea that there was [liquid] water underneath either of Antarctica's ice sheets (there is an eastern and western one) seemed preposterous." Gosnell, p. 46.
 21. Peter T. Doran et al., "Formation and Character of an Ancient 19-Meter Ice Cover and Underlying Trapped Brine in an 'Ice-Sealed' East Antarctic Lake," *Proceedings of the National Academy of Sciences*, Vol. 100, 7 January 2003, pp. 26–31.

Does Recently Declassified Data Falsify Plate Tectonic Theory?

Ocean floors constitute 70% of earth's solid surface. They were largely unexplored between 1957 and 1970, when the plate tectonic (PT) theory was developed. It was frequently said that we knew more about Mars than about the ocean floor. As a result, the PT theory, which primarily attempts to explain features on the ocean floor, was developed in the blind, without the data needed to formulate it or test it. Why then was plate tectonics accepted with enthusiasm?

A Brewing Crisis. Before PT, the only theory that tried to explain Earth's major surface features, especially the obvious jig-saw fit of the Americas with the bulge of Africa, was the 1912 continental drift theory. It claimed, as its name implies, that the jig-saw fit was because the continents drifted apart. No one knew why a supercontinent broke apart or how the pieces could move. Did thousands of miles of solid rock plow through thousands of miles of solid rock? Why couldn't Earth-science experts explain the fit that everyone could plainly see? (You who have read pages 109–433, now understand all that—and much more.)

The year 1957-1958 was designated, with much publicity, as the “International Geophysical Year,” a year in which scientists in 67 cooperating countries would conduct studies addressing festering questions about the earth. Adding to the drama, the Soviet Union placed Sputnik (Earth's first man-made satellite) in orbit in 1957, a monumental achievement that alarmed the entire free world. The United States Congress, fearful that the United States was falling behind in science and technology, threw vast amounts of money into several scientific efforts, one of which was to better understand the ocean floor. (Another was to promote the teaching of evolution.)

Problems also reigned in geology classrooms. One very experienced geology professor of that time, Dr. Douglas A. Block, frequently told me how embarrassed he and other geology professors felt walking into class knowing students would ask obvious questions professors could not answer. [See Dr. Block's endorsement of the hydroplate theory on page i.] So when the plate tectonic theory was finally proposed, it was greeted with great fanfare, because Earth's features might be explained by exciting new mechanisms: seafloor spreading, subduction, mountain formation, mantle circulation, hot spots, transform faults, and flipping magnetic poles—none of which has ever been seen or measured—only inferred with vivid imaginations. PT advocates assure us these mechanisms operate too slowly to see—over billions of years. Students seldom questioned these claims; questioning might show disrespect or a poor understanding, jeopardizing their degrees.

Another development in a completely different field was to play an even bigger role. At the end of World War II, civilization faced a huge problem. The cold war had begun, and nuclear warfare was a growing threat.

The United States, to deter nuclear war with the Soviet Union, developed a strategy, called *the triad*. It had three components: (1) land-based, nuclear-tipped missiles in hardened underground silos, (2) intercontinental bombers loaded with nuclear weapons, and (3) the most potent of all, submarines hidden deep in the world's oceans, carrying intercontinental missiles, many with multiple nuclear warheads. A sneak attack by the Soviets might destroy one or even two components of the triad, but retaliation by surviving components would surely follow.

Soviet submarines were less able to hide, because they were noisy and the U. S., for national defense purposes, was rapidly learning where every wrinkle, crack, and volcano was on the ocean floor—a gigantic and expensive task. Therefore, ocean floor data was highly classified and, until recently, not available to plate-tectonic theoreticians.

The Data Finally Released. One U.S. Navy scientist, N. Christian Smoot, an evolutionist, spent 32 years precisely mapping the ocean floor. His book, *Tectonic Globaloney: Closing Arguments* (Author House Press, 2012), describes discoveries on the ocean floor that falsify plate tectonics. Smoot, a veteran of 67 cruises, was responsible for declassifying some of this data for use outside the U.S. Navy. He says he “devoutly believed” the plate tectonic theory, but now knows it is “baloney” or “tectonic globaloney.” Based on features he sees on the ocean floor, Smoot concludes that **subduction does not occur, and the seafloor is not spreading.**

Below, in italics, are his words from the back cover of his book:

Forty-five years after the synthesis of the plate tectonic hypothesis, much newer and better information has been gathered by the seagoers of the world [and by satellites]. Contrary to popular opinion among earth scientists, the purveyors of plate tectonics are the present-day snake oil salesmen.

[Plate tectonics] is fraught with misinformation and misconceptions. It is in need of a massive make-over. Midocean ridge spreading does not occur universally, especially in Iceland and the North Pacific basin. Deep earthquakes do not define a descending slab; in fact, do not even occur in most places along the trenches. Therefore, subduction does not occur. Continental drift is a figment of overly active imaginations.

Fracture zones [distorted in National Geographic maps in a way that supports PT], rather than showing the direction of seafloor spreading, leave nothing more than a pattern of at least four different directions on the ocean floor as they intersect in a random fashion.

Plate tectonics does not work.

For specific details on plate tectonics and to understand its replacement—the **hydroplate theory**—see pages 109–433.

Why Have So Few Human Fossils Been Found?

From the genealogies given in Genesis 5 and 11, we noted on page 505 that those in the patriarchal line—from Adam to Joseph—had many children. If

- ◆ that population growth rate continued, and
- ◆ death rates were not unusually high,

the world's population at the time of the flood would have exceeded today's population of about 7 billion people. Therefore, one might expect to find many human fossils. Instead, only a few have been found. [See [“Fossil Man” on page 14.](#)] Some pre-flood, human artifacts and footprints have also been found. [See [“Human Artifacts” on page 39](#) and [“Humanlike Footprints” on page 38.](#)] While a few of these can be questioned or debated, the fact remains there are some pre-flood human fossils, artifacts, and footprints. To explain why there are not more human fossils, we must examine the two bulleted assumptions above.

Did this population growth rate continue until the flood?

Probably not. *The Book of Jasher*, mentioned twice in the Bible (Joshua 10:13 and II Samuel 1:18), is described on page 490. *Jasher* contains over 3,000 years of history, from the creation of Adam and Eve, continuing through the flood, and ending with Israel's entry into Canaan—the promised land. *Jasher's* description of conditions before the flood—consistent with Genesis 6:1–13—may explain why and how birth rates dropped sharply.

For in those days the sons of men began to trespass against God, and to transgress the commandments which He had commanded to Adam, to be fruitful and multiply in the earth. And some of the sons of men caused their wives to drink a draught that would render them barren, in order that they might retain their figures and whereby their beautiful appearance might not fade. (Jasher 2:19–20)

This helps us understand why God emphasized—both before and after the flood—to be fruitful and multiply.

- ◆ Genesis 1:22. *And God blessed them, saying, “Be fruitful and multiply.”*
- ◆ Genesis 1:28. *And God blessed them; and God said to them, “Be fruitful and multiply, and fill the earth,”*
- ◆ Genesis 8:17. *“... be fruitful and multiply on the earth.”*
- ◆ Genesis 9:1. *And God blessed Noah and his sons and said to them, “Be fruitful and multiply, and fill the earth.”*
- ◆ Genesis 9:7. *“And as for you, be fruitful and multiply; Populate the earth abundantly and multiply in it.”*
- ◆ Genesis 35:11. *God also said to him, “I am God Almighty; Be fruitful and multiply;”*

Were death rates unusually high before the flood?

Yes. About 120 years before the flood *“the wickedness of man was great on the earth, and every intent of the thoughts of his heart was only evil continually.”* (Genesis 6:1,5) Human behavior was so wicked that God grieved and was sorry He had made man. Therefore, God decided to

destroy all but Noah (the only blameless person on earth) and his family. We find it difficult to imagine how bad things were, but *Jasher* reports in some detail on the sensual indulgence and violence that developed before the flood.

And every man made unto himself a god, and they robbed and plundered every man his neighbor as well as his relative, and they corrupted the earth, and the earth was filled with violence. And their judges and rulers went to the daughters of men and took their wives by force from their husbands according to their choice, ... and God saw the whole earth and it was corrupt, for all flesh had corrupted its ways upon earth, all men and all animals. (Jasher 4:17–18)

Jasher 4:5–5:5 briefly describe the premature deaths from violence and famine for many of the wicked and all but one of the followers of God—Noah.

Jasher is a family history of the Hebrews. It was probably begun by Joseph, Egypt's second in command under Pharaoh. *Jasher* incorporated earlier documents and was updated by later Hebrews. No doubt it contains some errors and embellishments, but it supports many accounts contained in the first five books of the Bible with fascinating details.

For example, according to *Jasher* 6:14–17, Noah warned people (daily) for 120 years that God would destroy the earth, but it took Noah only five years to build the Ark. After Methuselah died, God told Noah and his family to enter the Ark. Seven days later, *“all the fountains of the deep were broken up, and the windows of heaven were opened, and the rain was upon the earth forty days and forty nights.”* *Jasher* explains that when the flood began, the world's population was at least 700,000. Men and women, exhausted by the falling rain, came to Noah and the Ark pleading to be let in. *“And Noah, with a loud voice, answered them from the Ark, saying, ‘Have you not all rebelled against the Lord, and said that he does not exist? Therefore, the Lord brought upon you this evil to destroy and cut you off from the face of the earth.’”* (*Jasher* 6:19)

Let us not forget the indescribable violence of the flood, detailed in Part II of this book. God said He would *“blot out”* (not just kill) *“man whom I have created from the face of the land.”* (Genesis 6:7) The flood may have done just that—blotted out, erased—human remains from the earth.

Based on the recorded (although not inspired) history in *The Book of Jasher*, when the flood began, the world's population may have been one-ten thousandth of what is today. If so, both of the commonly made assumptions listed in the first paragraph are probably incorrect. As Genesis 6:11 states, *“the earth was corrupt in the sight of God, and the earth was filled with violence.”* It should not be surprising that only a few human fossils have been found in the hundreds of millions of cubic miles of flood sediments.

How Could Saltwater and Freshwater Fish Survive the Flood?

Related Questions: Why didn't the hot, salty, subterranean water kill all freshwater fish during the flood? How did saltwater fish survive before the flood? Were preflood fish adapted to saltwater or fresh water?

Chemistry of Body Fluids in Fish. Blood and other body fluids of almost all fish, freshwater and saltwater, have surprisingly similar chemistry. Their blood's salinity, for example, is between that of fresh water and saltwater.¹ For reasons that will soon be apparent, a typical preflood sea probably had a small salt content, as if you mixed two parts of fresh water with one part of seawater. However, just as oceans and seas today have variations in salt content, variations probably existed in and among preflood seas—perhaps large variations.

Living things have many marvelous, semipermeable membranes that allow some liquids or gases to pass through, but not others. For example, capillary walls are semipermeable membranes. Oxygen in our lungs can pass through capillary walls and mix with our blood, but blood does not normally pass through those walls. *Substances that can pass through the membrane (such as oxygen) will, on balance, go from the higher concentration (in the lungs) to the lower concentration (in the blood). This is called osmosis.*

Fish have a water problem. Freshwater fish have greater salinity in their blood (less concentration of water) than is in the water they swim in, so water seeps into their blood by osmosis. To correct this problem, freshwater fish seldom drink, and their kidneys secrete a watery urine. Conversely, saltwater fish have less salinity in their blood than is in their saline environment, so osmosis forces water from their bodies. Their kidneys pump out so little water that saltwater fish seldom urinate.

Mixing. During the flood, fish would have tried to stay in the most comfortable regions of the volume of water that was their preflood habitat. Salty, subterranean water, erupting onto the earth's surface, would not have rapidly mixed with the less-salty preflood seas. In fact, the larger a preflood sea, the slower it mixed and diffused, and the

better it insulated its fish from muddy, hot, salty currents during the flood.² Besides, preflood seas would have tended to "float" on the denser, muddier, saltier water.

In one 55-gallon experiment, a layer of freshwater floated on a typical layer of seawater. Several freshwater fish, salt-water fish, and other organisms placed in the tank lived in their respective environments for 30 days. The fish even made brief excursions into the more hostile environment.³ If the experiment were scaled up to the size of a global flood, mixing would occur at increasingly slower rates *per unit volume*.

Natural Selection. After 150 days (according to Genesis 8:3), floodwaters began to drain into newly formed ocean basins. Fish trapped in continental basins were the potential ancestors of our freshwater fish. Rainfall over the next several decades diluted the salt concentration in most postflood lakes.⁴ Natural selection eliminated fish in each generation that could not tolerate the declining salinity. Those that could, had less competition for resources and could reproduce their tolerance for lower salinities. Because fish reproduce frequently and profusely, *limited* variations in each generation allowed rapid adaptation in their ability to control the water in their bodies. This is microevolution, not macroevolution. No new organs were needed.

Meanwhile, fish that ended up in the new oceans either had to tolerate slowly increasing salinity or face extinction. Survivors became saltwater fish. Those unable to adapt are now extinct. (This largely explains why marine animals have experienced the most extinctions.) Some fish, the best-known being salmon, are adapted to both fresh water and saltwater. Wider salinity tolerances, such as those of salmon, may have existed before the flood.

Design. The ability over many generations to adapt to changing environments is a wonderful feature designed into all life. Without this capability, extinctions would be more common, and life would eventually cease—beginning, perhaps, near the bottom of the food chain. But adaptation has never produced macroevolution.

References and Notes

1. Sylvia S. Mader, *Biology*, 3rd edition (Dubuque, Iowa: Wm. C. Brown, Publishers, 1985), pp. 580–581.
2. Suggestive of the time required for mixing a large body of water is the following:

If we think of the oceans as big interconnected basins, we can ask our question about circulation rates in terms of the average length of time that a water molecule spends in each basin. The results of such calculations indicate that water molecules spend from 200 to 500 years in the deep Atlantic before

being transferred to another reservoir ... Karl K. Turekian, *Oceans*, 2nd edition (Englewood Cliffs, New Jersey: Prentice-Hall, Inc., 1976), p. 38.

3. E. Norbert Smith and Stephen C. Hagberg, "Survival of Freshwater and Saltwater Organisms in a Heterogeneous Flood Model Experiment," *Creation Research Society Quarterly*, Vol. 21, June 1984, pp. 33–37.
4. Dilution rates depend on many things, including drainage rates into and out of a lake, evaporation, and rainfall.

Why Did the Floodwater Drain So Slowly?

After the Ark landed on the mountains of Ararat, 74 days passed before the tops of surrounding mountains were visible (Genesis 8:3–5). Shouldn't most of the floodwater have quickly drained off the high, thickened continents and into the new, deep ocean basins? And why did all passengers (except a few birds) stay on the Ark for 221 days after it landed? Surely, the eight humans wanted to leave that noisy, smelly boat, breathe fresh air, stretch, stand on solid ground, cease caring for the animals, and explore the new earth. First of all, the earth was still a hostile place. Secondly, powerful forces, slowly unleashed at the center of the earth, produced elevation changes at the earth's surface for years. Let's briefly review pages 111–192.

Review. During the flood phase, the escaping subterranean water widened the rupture, so the chamber floor directly below steadily bulged upward—similar to that shown in Figures 63 and 65 on pages 130–131. This upward arching increased stresses and melting below that bulging floor. Deep fractures resulted in slippage, friction, instantaneous melting (lubrication) along vertical faults, and even greater slippage. This, in turn, triggered deeper stresses, fractures, melting, and uplift of the new Atlantic floor.

With this steady uplift, the hydroplates eventually began sliding downhill, away from the rising Mid-Atlantic Ridge. This removal of weight from the rising Ridge accelerated the rise, increased deep fracturing and slippage—and, near the center of the earth, melting. Within hours, the entire Atlantic floor was rapidly rising; that, in turn, pulled down the Pacific plate and shifted surface water violently toward the Pacific side of the earth. The subsiding Pacific plate and the rising Atlantic floor steepened the slopes on which the hydroplates slid away from the Mid-Atlantic Ridge. Gravitational settling of dense magma deep in the earth released more heat than did frictional sliding along faults. [See Endnote 47 on page 186.] The more the melting, the greater the heat released by gravitational settling. This runaway melting at the exact center of the earth began the formation of earth's core. [See “**Forming the Core**” and Figure 89 on page 160.]

Drainage. When rock melts below the crossover depth, its volume decreases. [See “**Magma Production and Movement**” on page 156.] Therefore, the inner earth shrank as it melted. This, in turn, slowly compressed and deformed earth's mantle and crust. Elevations at the earth's surface became increasingly varied in the months and years after the flood—much like the wrinkling skin of a shrinking, drying apple. Consequently, the floodwaters slowly but steadily drained as the wrinkling continued.

The growing liquid core produced irregular elevations at the earth's surface in a second way. Imagine a unique waterbed. Rather than its water being a liquid, it is a uniform layer of ice. Resting on the bed are two types of blocks: wood (representing continents) and bricks (representing the denser

magma from the upper mantle that had spilled primarily onto the new Pacific Basin in the months and years after the flood). As the ice melts, the bricks slowly sink into the liquid, forcing the wood to rise in compensation. Similarly, the denser ocean basins (density $\sim 3.0 \text{ gm/cm}^3$) and the mantle below them sank into the earth's new and growing liquid foundation—the earth's core. As they did, the less dense crust (density $\sim 2.7 \text{ gm/cm}^3$) and the mantle below the crust rose in compensation. This allowed more floodwater to drain into the new, deepening ocean basins, and probably accounts for the high Himalayan Mountains. So it took a few months before the tops of mountains surrounding the Ark could be seen—just as Genesis 8:3–5 states.

Summary. On the 150th day of the flood, the accelerating hydroplates, sliding away from the rising Mid-Atlantic Ridge on a layer of water, crashed, crushed, and buckled. Seashells were then on every major mountain range on earth. [See “**Seashells on Mountaintops**” on page 49.] Within hours, the Ark landed on the thickened crust. [See page 488.] For a few years, internal melting enlarged earth's liquid outer core, so elevations on earth became increasingly irregular: denser ocean basins slowly sank, lifting the lighter continents (all relative to the core), so most of the floodwaters drained into those new ocean basins.

The compression event at the end of the flood crushed, buckled, and thickened each hydroplate, so their masses were concentrated on a smaller base. [See Figure 50 on page 117.] Therefore, continents and the new mountains sank very slowly (relative to the mantle) to their equilibrium levels in the solid, but deformable, mantle, forcing the ocean basins to gradually rise in compensation (again, relative to the mantle). Simply stated, the crust and mountains sank relative to the mantle, but rose relative to the core.

Sea level. Because the preflood chamber floor into which the floodwaters drained was far below the preflood surface of the earth, sea levels for centuries after the flood, were much lower than today. [See Pages 515–517.] This allowed animals and humans to migrate between temporarily connected continents. However, sea level eventually rose to today's levels, because, as stated above, (1) the post flood ocean floor rose in compensation for the sinking of the new mountains and thickened continents into the mantle, and (2) magma spilled up onto the Pacific floor which raised sea level about 4,500 feet. [See page 169.]

Years were required to approach equilibrium levels in the newly formed *liquid* outer core, but centuries-to-millennia were needed for continents to sink into the *solid* mantle. Earthquakes, tsunamis, volcanic eruptions, and very slow shifts of blocks of crust and mantle toward the Pacific still occur [Figure 94 on page 171], demonstrating that perfect equilibrium has not been reached. Consequences of the flood, at times catastrophic, are still with us.

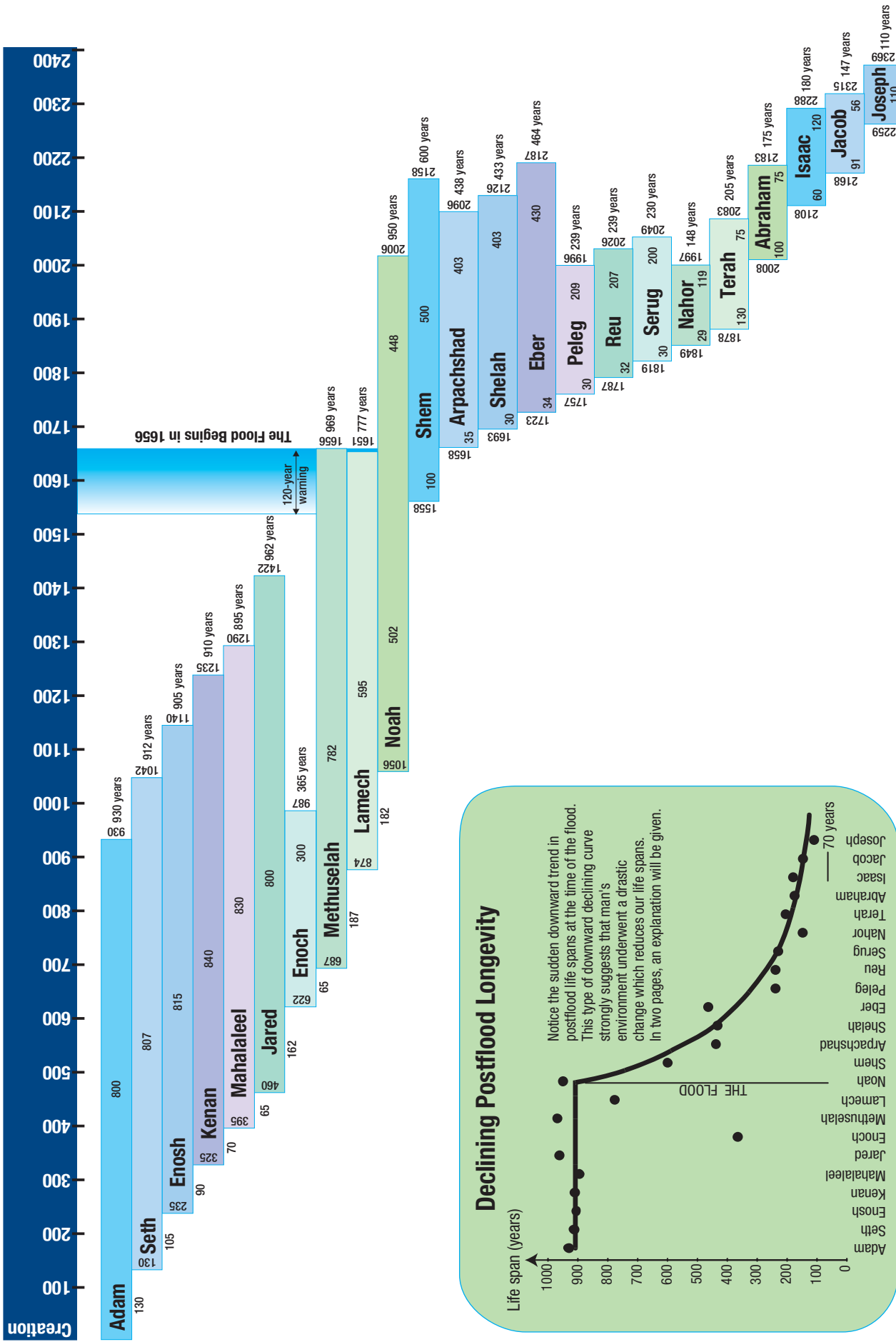

Figure 247: Genealogy Chart. This chart is based on the ages of the patriarchs as given in the Masoretic (Hebrew) text. Based on the Septuagint (Greek) text, the flood was 2242 years after the creation. [See “When Was the Flood, the Exodus, and Creation?” on pages 482–484.]

According to the Bible, When Was Adam Created?

The ages and relationships of the patriarchs, given in Genesis and shown [Figure 247](#), allow one to estimate the time of Adam's creation at slightly more than 6,000 years ago. What uncertainties are involved?

- These ages are based on the Hebrew (Masoretic) text, used in almost all English translations. The corresponding numbers in the Samaritan and Greek (Septuagint) texts place Adam's creation about 6,200 and 7,300 years ago, respectively. Which text is closest to the original is uncertain. If one uses the Septuagint, then Methuselah died 14 years after the flood—a logical impossibility, since he was not on the Ark. (Some sources say that the name Methuselah means, "When he is dead, it shall be sent." According to the numbers in [Figure 247](#) (the Masoretic text), the flood began in the year Methuselah died.)
- Fractions of a year should be added or subtracted, because each patriarch was probably not born on his father's day. Also "became the father of" or "begot" may have referred to the time of conception, not the time of birth.
- Some ages in all three texts have evidently been rounded, because too many numbers end in zero or five. Rounding 15 or so ages in Genesis probably would not inject more than 20 years of total error. This rounding might have been intended to absorb the fractions of the year mentioned in b above.
- Disagreements exist concerning Terah's age when Abraham was born. Some argue that Terah was 70 years, not the favored 130 years shown in this chart.¹
- Luke 3:36 lists Cainan as the son of Arpachshad and the father of Shelah. In Genesis, Cainan's name occurs only in recent copies of the Septuagint—not the oldest. Nor is Cainan in the oldest known copy of Luke. Therefore, a copyist probably added Cainan's name inadvertently, perhaps taking it from Luke 3:37.
- Most students of the subject place the death of Joseph (Jacob's son) between 1606 B.C. and 1690 B.C. An error in this date will add a corresponding error to the year of Adam's creation.

Theistic evolutionists often raise two objections to the chronological information in Genesis.

- Some say, pointing to Cainan, that the genealogies contain gaps. However, the possibility of gaps is irrelevant to the year of Adam's creation. Even if many

generations existed between two consecutive patriarchs on this chart, the time between their births is fixed by Genesis, no matter how many generations might be missing. (For example, Enosh was born 105 years after Seth's birth.) The writer or compiler of this information had a careful, systematic, and mathematical way of linking the chronology into one continuous family record—in contrast to other genealogies in the Bible.

- Others have said that the long ages of the pre-flood patriarchs resulted from lunar months being incorrectly counted as years. If so, Mahalaleel and Enoch were 5 years old when they had children.

This chart contains other interesting details.

- Noah's son Shem, born before the flood, nearly outlived Abraham. Surprisingly, many people think of Noah and Shem as relatively ancient (or imaginary) but accept Abraham as historically recent. Noah died only two years before Abraham was born.
- Notice the continuous chain of overlapping life spans of Adam, Methuselah, Shem, and Abraham or Isaac.
- Enoch's time on earth was cut short, but not by death. [See Hebrews 11:5.]
- Notice the systematic change in life spans after the flood, as explained in "[Why Did People Live for about 900 Years before the Flood?](#)" on pages 510–512.

Genesis 5 says that each of the first 9 patriarchs had "*other sons and daughters*" besides the son in the patriarchal line. Simply stated, each family had *at least* 5 children: 3 sons and 2 daughters. But what must have been the average number of children for there to have been a better than 50-50 chance that all 9 families had at least 3 sons and 2 daughters? Statistically, all 9 families would probably have had at least 3 sons and 2 daughters if each family had 10 or more children. (Conversely, all 9 families would probably not have had 3 sons and 2 daughters if each family had 9 children or less.)

Had pre-flood families averaged 10 or more children and if death rates were typical of what we have seen in the last few thousand years, the world's population would have exceeded today's population of 7 billion people. However, as you will see in "[Why Have So Few Human Fossils Been Found?](#)" on page 501, there are historic and biblical reasons for concluding that before the flood average family size decreased substantially and death rates increased.

References and Notes

1. Genesis 11:26 says that "*Terah lived 70 years, and became the father of Abram* [Abraham], *Nahor and Haran.*" This does not mean that Terah was 70 years old when Abram was born. Children are not always listed in birth order. Noah's three sons were not. [See Genesis 5:32, 9:24, and

10:21.] The son mentioned first may simply be the most prominent, as was Abraham. So, we must look deeper.

Genesis 11:32, Genesis 12:4, and Acts 7:4 tell us that Terah lived 205 years, and when Abram was 75 years old, Terah died. So, Terah was 130 years old when Abram was born.

How Accurate Is Radiocarbon Dating?

First, an Analogy: Red Ink in Water

Imagine a large swimming pool into which one drop of red ink falls each year. The water dilutes the ink so much that even after a few thousand years very little pinkness can be seen in the pool. Furthermore, the ink in water slowly disappears with a half-life of 5,730 years. What does that half-life mean?

If you could watch 100 carbon-14 atoms (or red ink molecules which, in this analogy, represent carbon-14), you would on rare occasions see a carbon-14 atom decay and become nitrogen-14. After 5,730 years, half (or 50 carbon-14 atoms) would remain. After another 5,730 years only half of those 50 (or 25 carbon-14 atoms) would remain. Think of the red ink molecules slowly disappearing at the same rate.

One day, about 5,000 years ago, most of the water suddenly drained from the pool. Since then, the amount of water only fills a bathtub, but one drop of red ink continued to fall into the bathtub each year. With so little water to dilute the red ink, the water's pinkness steadily increased, but not indefinitely. Why? Because each molecule of this imaginary ink has a half-life of 5,730 years, a point was reached when as many molecules of red ink disappeared each year as fell into the bathtub. Therefore, today the degree of pinkness in the bathtub's water is not changing.

In this analogy, the red ink represents carbon-14 that forms in the upper atmosphere at the rate of 21 pounds per year and spreads throughout the biosphere. The swimming pool's water represents the huge amount of the normal carbon (carbon-12) that was in the biosphere before the flood. Because about half of today's surface water was in the subterranean chamber before the flood, there was more forested land area before the flood. Most of the carbon in the vast preflood forests is now our coal and oil deposits. Before the flood, all that normal carbon, produced by forests, greatly diluted the carbon-14 that was steadily being added to the biosphere.

During the flood, about 5,300 years ago,¹ most of the carbon was removed from the biosphere when animals and plants (especially Earth's vast forests) were buried and fossilized in thick layers of sediments, producing Earth's huge coal, oil, and methane deposits. Since the dead plants and animals could no longer take in new carbon-14, the ratio of carbon-14 to carbon-12 in their dead cells steadily decreased (with a half-life of 5,730 years) from the atmosphere's preflood concentration. This allows us to date the time of death—if we know the amount of carbon-14 in the atmosphere when they died. But much of the carbon-14 in today's atmosphere was produced by electrical activity² during the flood, as explained on pages 379–433. If we mistakenly thought those plants and animals had today's higher concentration of carbon-14 when they were living, we would incorrectly conclude that their low concentration of carbon-14 was due to the passing of about 40,000 years. Therefore, a year based on carbon-14 dating would not equal a calendar year.

Radiocarbon ages less than 3,500 years old are probably accurate. However, before accepting any radiocarbon date, one should know how the technique works, its limitations, and its assumptions. One limitation is that the radiocarbon technique dates only material that was once part of an animal or plant, such as bones, flesh, or wood. It cannot date rocks *directly*. To understand the other capabilities and limitations of radiocarbon dating, we must understand how it works and consider the flood.

Most carbon atoms weigh 12 atomic mass units. However, roughly one in a trillion carbon atoms weighs 14 atomic mass units. This carbon is called *carbon-14*—or **radio**-carbon, because it is **radio**active. Half will decay in about 5,730 years to form nitrogen-14. Half of the remaining half will decay in another 5,730 years, and so on.

Two Sources. Carbon-14 comes from two sources: (1) the upper atmosphere where cosmic rays convert nitrogen-14 to about 21 pounds of carbon-14 per year, and (2) the earth's crust where some neutron-heavy radioisotopes produce “cluster decay” by emitting small amounts of

carbon-14 nuclei.³ The first source is widely known; few are aware of the second, which was discovered in 1984.

As explained in “**The Origin of Earth's Radioactivity**” on pages 379–433, neutron-heavy and superheavy radio isotopes were produced in abundance during the flood, so when those isotopes escaped into the atmosphere and decayed, some unknown but significant quantity of carbon-14 was released. Smaller, but also unknown, amounts of carbon-14 are still escaping from the crust.⁴

Most carbon-14 in the atmosphere quickly combines with oxygen to form radioactive carbon dioxide. Plants can then take in carbon dioxide, incorporating in their tissues both carbon-14 (radioactive) and normal carbon-12 (non-radioactive) **in the same proportion as was in the atmosphere at that time**. Therefore, carbon-14 moves up the various food chains to enter animal tissue—again, in about the same ratio as carbon-14 had with carbon-12 in the atmosphere.

When a living thing dies, its radiocarbon loss (decay) is no longer replenished by intake, so its radiocarbon steadily decreases with a half-life of 5,730 years. If we knew the ratio

of carbon-12 to carbon-14 in an organism when it died, we could date its death. The assumption usually made is that the atmospheric ratio of carbon-14 to carbon-12 has always been about what it is today—about one in a trillion—so every living thing died with that ratio of carbon-14 to carbon-12 in its tissues.⁵ However, that assumption will be shown (in a few pages) to be terribly wrong for organic material living before or soon after the flood.

The worldwide flood invalidated this standard assumption in a second way by uprooting and burying pre-flood forests. Less carbon was then in the biosphere to dilute the carbon-14 continually entering the atmosphere, so the ratio of carbon-14 to carbon-12 in the atmosphere sharply increased after the flood began, as shown by line B in Figure 248. If that ratio has doubled since the flood and we did not know it, radiocarbon ages of things that lived soon after the flood would appear to be one half-life (or 5,730 years) older than their true ages. If that ratio quadrupled, organic remains would appear 11,460 ($2 \times 5,730$) years older, etc. Therefore, a “radiocarbon year” would not correspond to an **actual** year.

As explained in Figure 248, recent measurements show that the ratio of carbon-14 to carbon-12 has been building up in the atmosphere.⁶ However, for the last 3,500 years, the increase in the ratio has been slight but measurable.

Radiocarbon dating of vertical sequences of organic-rich layers at 714 locations worldwide has consistently shown a surprising result.⁷ Radiocarbon ages that are a few thousand years old do not increase *steadily* with depth, as one might expect. Instead, they increase at an accelerating rate. In other words, the concentration of carbon-14 is unexpectedly low in the lower organic layers and becomes more so the deeper the layer.

Tree-ring dating provides information on past concentrations of carbon-14 in the atmosphere. Some types of trees growing at high elevations with a steady supply of moisture will add only one ring each year. In other environments, multiple rings can be added in a year.⁸ A tree ring’s thickness depends on the tree’s growing conditions, which vary from year to year. Some rings may show frost or fire damage. By comparing sequences of ring thicknesses and ring damage in two different trees, a correspondence can sometimes be shown. Trees of the same species that simultaneously grew within a few hundred miles of each other may have similar patterns. Trees of different species or trees growing in different environments have less-similar patterns.

Claims are frequently made that these tree-ring thickness patterns of wood growing today can be matched up with those of some scattered pieces of dead wood, so that tree-ring counts can be extended back more than 8,600 years. This is incorrect. These claimed “long chronologies” begin with either living trees or dead wood that can be accurately dated by historical methods.⁹ This carries the chronology back perhaps 3,500 years. Then, the more

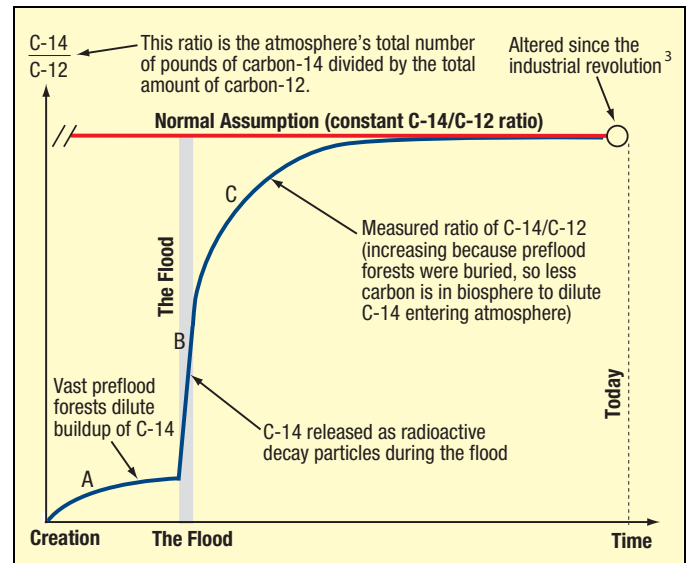

Figure 248: Increasing Amounts of Carbon-14. *If one thought that the C-14/C-12 ratio had always been what it is today, one would incorrectly conclude that small amounts of carbon-14 in fossils meant that much time had passed. Instead, those organisms had less carbon-14 when they died.*

Radiocarbon dating requires knowing the ratio of carbon-14 to carbon-12 in the atmosphere when the organic matter being dated was part of a living organism. The assumption (shown in red), which few realize is being made, is that this ratio has always been what it was before the Industrial Revolution—about one carbon-14 atom for every trillion carbon-12 atoms. Willard Libby, who received a Nobel Prize for developing this technique, conducted tests in 1950 that showed more carbon-14 forming than decaying. Therefore, the amount of carbon-14 and the ratio must be increasing. He ignored his test results, because he believed that the earth must be more than 20,000–30,000 years old, in which case the amount of carbon-14 must have had time to reach equilibrium and be constant.⁶ In 1977, Melvin Cook did similar, but more precise, tests which showed that the ratio was definitely increasing, even faster than Libby’s test indicated.

Before the flood, about half the water on the earth today was under the earth’s crust, so the pre-flood earth had less sea area and more land and forest area. The small amount of carbon-14 that cosmic radiation produces in the upper atmosphere (about 21 pounds per year) was, therefore, diluted before the flood by the vast amounts of carbon-12 in the lush vegetation growing on the earth. That vegetation, buried during the flood, became our coal, oil, and methane deposits. The blue curve [line A] gradually rose from zero, because at the creation, cosmic radiation began producing carbon-14. During the flood [line B], some carbon-14 entered the atmosphere as radioactive decay products. (That is still happening.^{1,2}) Therefore, the ratio of carbon-14 to carbon-12 has steadily increased [line C] since the flood—but at a decreasing rate, because the more carbon-14 is in the atmosphere, more carbon-14 decays occur.

questionable links are made based on the judgment of a tree-ring specialist. Sometimes “missing” rings are added.¹⁰ Each tree ring’s width varies greatly around the tree’s circumference. Standard statistical techniques could show how well the dozen supposedly overlapping tree-ring thickness patterns fit. However, in at least two instances tree-ring specialists have refused to subject their judgments to these statistical tests and would not release their data, so others could do these statistical tests.¹¹

Several laboratories in the world are now equipped to perform a much improved radiocarbon dating procedure. Using atomic accelerators, a specimen's carbon-14 atoms can now actually be counted, giving a more precise radiocarbon date with even smaller samples. The standard, but less accurate, radiocarbon dating technique counts only the rare disintegrations of carbon-14 atoms, which are sometimes confused with other types of disintegrations.

This new atomic accelerator technique has consistently detected carbon-14 in every organic specimen—even materials that evolutionists claim are millions of years old, such as coal and dinosaur bones.¹² Small amounts are found so often among various specimens that contamination can probably be ruled out. Ancient human skeletons, when dated by this new “accelerator mass spectrometer” technique, give surprisingly recent dates. In one study of eleven sets of ancient human bones, all were dated at about 5,000 radiocarbon years or less!¹³

Radiocarbon dating of supposedly very ancient bones should provide valuable information. Why are such tests rarely performed? Researchers naturally do not waste money on a technique that destroys their specimen and provides no specific age. In an organic specimen thought to be older than 100,000 radiocarbon years, all carbon-14 would have decayed, so an age could not be determined. Therefore, researchers will not radiocarbon date specimens they think are older than 100,000 years. Conversely, if carbon-14 is in

any specimen, it must be less than 100,000 years old, even if the researcher believes the specimen is millions of years old.



PREDICTION 56: Bones or other organic remains that contain enough carbon and are believed to be older than 100,000 years will be shown to be relatively young in blind radiocarbon tests. Blind tests are explained on page 97. (This prediction, first published in the 6th edition (1995), p. 157, has now been confirmed.¹⁴)

Very precise measurements now show that most fossils—regardless of presumed “geologic age”—have roughly the same ratio of carbon-14 to carbon-12. (This includes fossil fuels: coal, oil, and methane.) Therefore, those organisms must have been living about the same time—and less than 100,000 years ago. Because almost all fossils are preserved in water deposited sediments, all this former life was probably buried in a recent, global flood.¹⁵

Radiocarbon dating is becoming increasingly important in interpreting the past. However, one must understand how it works and especially how the flood affected radiocarbon dating. Radiocarbon ages less than 3,500 years are probably accurate. **Ages around 40,000 radiocarbon years, which are typical of coal, have much younger true dates—near the time of the flood, roughly 5,000 years ago.** [See “**When Was the Flood, the Exodus, and Creation?**” on pages 482–484.]

References and Notes

1. The 3290 B.C. date for the flood (about 5300 years ago, give or take 100 years) is explained beginning on page 482.
2. “... ²²³Ra nuclei occasionally, but significantly, decay with the loss not of an α -particle but of a carbon-14 (¹⁴C) fragment.” John Maddox, “Exotic Nuclear Decay Discovered,” *Nature*, Vol. 307, 19 January 1984, p. 207.
 - ◆ H. J. Rose and G. A. Jones, “A New Kind of Natural Radioactivity,” *Nature*, Vol. 307, 19 January 1984, pp. 245–247.
 - ◆ Today, this source of carbon-14 is small. However, during the flood, when nuclear reactions and decay were extreme, much larger amounts of carbon-14 must have been produced. [See “**The Origin of Earth’s Radioactivity**” on pages 379–433.]
3. “[This] unveils a previously unknown natural source of isotopes in the atmosphere, in addition to the irradiation of Earth by cosmic rays. These isotopes include nitrogen-15, carbon-13, and carbon-14, the last of which is widely used in the dating of archaeological artefacts and artworks. In fact, the contribution of thunderstorms [and the electrical activity in the earth’s crust during the flood] to Earth’s carbon-14 abundance could be comparable in some regions to that of cosmic irradiation.” Leonid Babich, “Thunderous Nuclear Reactions,” *Nature*, Vol. 551, 23 November 2017, p. 443.
4. Isotopes that are now known to decay by emitting a carbon-14 nucleus (plus other particles) include:
 - francium-221, radium-221, radium-222, radium-223, radium-224, actinium-223, actinium-225, and radium-226.
 During the flood, abundant superheavy isotopes, which briefly formed, would have produced much more carbon-14.
5. Actually, several minor corrections are made. For example, since the Industrial Revolution began, human activity, especially the burning of fossil fuels (which contains little carbon-14), has altered the ratio of carbon-14 to carbon-12 in the atmosphere. Also, nuclear explosions in the atmosphere temporarily tripled the ratio.
6. In 1952, when Willard Libby proposed the radiocarbon dating technique, he called attention to the critical assumption that the ratio of carbon-14 to carbon-12 has been constant. He tested that assumption by making various measurements and calculating how rapidly carbon-14 was forming and decaying. Surprisingly, he saw that carbon-14 was entering the atmosphere faster than it was decaying. That meant there was much less atmospheric carbon-14 in the past. If we did not know that, we would incorrectly conclude that the lack of carbon-14 in dead animals and plants was because much time had passed and the carbon-14 had decayed.
 - Libby believed that his measurements were in error, because he thought the earth was so old that a balance between formation and decay must exist. (He did not know

that carbon-14 is a decay product from inside the crust and is steadily leaking into the atmosphere.) He wrote:

If the cosmic radiation has remained at its present intensity for 20,000 or 30,000 years, and if the carbon reservoir has not changed appreciably in this time, then there exists at the present time a complete balance between the rate of disintegration of radiocarbon atoms and the rate of assimilation of new radiocarbon atoms for all material in the life-cycle. Willard F. Libby, *Radiocarbon Dating* (Chicago: University of Chicago Press, 1952), p. 8.

In 1986, Libby's measurements were repeated with even greater accuracy. These results show that the out-of-balance condition has always been much greater than Libby believed. **Even today, radiocarbon is forming 28–37% faster than it is decaying.** This means that *the farther one looks back in time, the greater the out-of-balance condition would have been—until the time of the flood.* Changes in the atmosphere's carbon-14 to carbon-12 ratio, from 3,500 years ago to the Industrial Revolution, have been very small, because the biosphere has so much carbon-12. [See Melvin A. Cook, "Nonequilibrium Radiocarbon Dating Substantiated," *Proceedings of the First International Conference on Creationism*, Vol. 2 (Pittsburgh, Pennsylvania: Creation Science Fellowship, 1986), pp. 59–68.] This is what we would expect as a result of the flood.

- ◆ *"It now appears that the C14 decay rate ... is about 30 percent less than its production rate in the upper atmosphere."* William D. Stansfield, *Science of Evolution* (New York: Macmillan Publishing Co., 1977), p. 83.
- 7. R. H. Brown, "Implications of C-14 Age vs. Depth Profile Characteristics," *Origins*, Vol. 15, No. 1, 1988, pp. 19–29.
- ◆ Radiocarbon ages of seeds in ancient caves often span unreasonably long time periods, such as 2,000 years. [See, for example, Bruce D. Smith, "The Initial Domestication of *Cucurbita pepo* in the Americas 10,000 Years Ago," *Science*, Vol. 276, 9 May 1997, pp. 932–934. Also see, Wade Roush, "Squash Seeds Yield New View of Early American Farming," *Science*, Vol. 276, 9 May 1997, pp. 894–895.]
- 8. W. S. Glock and S. Agerter, "Anomalous Patterns in Tree Rings," *Endeavor*, Vol. 22, January 1963, pp. 9–13.
- 9. The oldest living tree known (called the *Methuselah Tree*) is a bristlecone pine in the White Mountains of California. Its age—5,062 years—is remarkably close to the time of the flood, about 5,300 years ago. It should not be surprising that some trees alive today started growing soon after the flood. [See **"When Was the Flood, the Exodus, and Creation?"** on pages 482–484.]
- ◆ *"A new record holder was recently recognized, a *Pinus longaeva* growing in the White Mountains of eastern California. The date on this tree was reported to me by Tom Harlan. The tree was cored by Edmund Schulman in the late 1950s but he never had a chance to date it [count the rings] before he died. Tom worked up the core only recently, and knows which tree it is. The tree is still alive, and the age given below, 5062, is the tree's age as of the growing season of 2012."* Rocky Mountain Tree-Ring Research at <http://www.rmtrr.org/oldlist.htm>.
- 10. Harold S. Gladwin, "Dendrochronology, Radiocarbon and Bristlecones," *Anthropological Journal of Canada*, Vol. 14, No. 4, 1976, pp. 2–7.
- 11. *"The entire chronology is the work of one laboratory, the director of which [C. W. Ferguson] has refused to allow critical study of the raw data."* For details, see Herbert C. Sorensen, "Bristlecone Pines and Tree-Ring Dating: A Critique," *Creation Research Society Quarterly*, Vol. 13, June 1976, p. 5.
 - ◆ Leading tree-ring specialists do not subject their judgments to statistical tests. In a private three-hour meeting (19 July 1989) I had with the director (Dr. Malcolm Hughes) and lead scientist (Dr. Austin Long) of the world's largest tree-ring laboratory (University of Arizona's Laboratory of Tree-Ring Research), both expressed no interest in doing so. A year before, a worker in this laboratory reported that circular reasoning was used in tree-ring chronologies. Wood specimens considered for "long chronologies" are first radiocarbon dated. If a date is old enough (perhaps by an erroneous reading), tree-ring specialists then look at the "old" specimen's ring thicknesses for a way to extend the "long chronology." This chronology is used to assure the public that radiocarbon dating has been calibrated by a continuous sequence of tree rings. [This unsound practice is also described by Henry N. Michael and Elizabeth K. Ralph, "'Quicke' ¹⁴C Dates," *Radiocarbon*, Vol. 23, No. 1, 1981, pp. 165–166.]
- 12. <http://newgeology.us/presentation48.html>
- 13. R. E. Taylor et al., "Major Revisions in the Pleistocene Age Assignments for North American Human Skeletons by C-14 Accelerator Mass Spectrometry," *American Antiquity*, Vol. 50, No. 1, 1985, pp. 136–140.
- 14. *"There is measurable carbon-14 in [75 samples of] material that should be 'dead' according to standard evolutionary theory;"* Paul Giem, "Carbon-14 Content of Fossil Carbon," *Origins*, Vol. 51, 2001, p. 6.

Giem addressed (on pages 6–30) possible sources of error, including contamination. He either eliminated them or determined that they were highly unlikely.

 - ◆ Personal communication: Walt Brown to Paul Giem, 4 April 2000; Paul Giem to Walt Brown, 10 September 2000.
 - ◆ John R. Baumgardner et al., "Measurable ¹⁴C in Fossilized Organic Materials," *Proceedings of the Fifth International Conference on Creationism* (Pittsburgh, Pennsylvania: Creation Science Fellowship, Inc., 2003), pp. 127–142.
- 15. *"Since it is believable that most fossil carbon has roughly the same ¹⁴C/C ratio, it is reasonable to conclude that all this carbon was in the biosphere at approximately the same time. In that case, since most, if not all, fossil carbon was deposited by water, the data suggest a flood of massive proportions, and that the biblical account has to be taken seriously."* Giem, pp. 26–27.

Why Did People Live for about 900 Years before the Flood?

Life spans suddenly began decreasing after the flood. [See Figures 247 and 249.] This “ski slope” type of decline (called an *exponential decay*) is one that engineers and scientists see frequently. It occurs when a system, in equilibrium (balanced) at one level, is suddenly disturbed and moves toward a new equilibrium state at a lower level.

Many have speculated on the cause of this well-known decrease, but few proposals fit all the following facts. The decline:

- ◆ began at the flood
- ◆ fits an exponential decay¹
- ◆ affected Shem, who carried *preflood* genetics
- ◆ affected the entire postflood population, regardless of latitude, elevation,² diet, nationality, or customs

Unfortunately, proposals that fit these facts cannot be tested experimentally, including what I will propose. However, the flood events already described fit all these facts *and would have steadily reduced longevity to what we see today.*

Some say life spans declined because the flood produced a “genetic bottleneck” (a population shrinkage). However, Shem avoided that bottleneck, because his genetics were fixed at his conception which was before the flood. Yet his drop in longevity was the greatest of all the patriarchs listed in Figure 249. Genetic bottlenecks also occur (a) in pioneering families or other small groups isolated for generations, and (b) in hundreds of breeding experiments with different animals. To my knowledge, no one has observed an exponential decay in those life spans.

While genetics certainly plays a role, it is not as large as we might imagine. Identical human twins who die of natural causes typically die more than 10 years apart. “*Two studies of human twins attribute most (>65%) of the variance to non-shared environmental factors.*”³ Genetically identical laboratory animals give similar surprising results.

As explained in “**The Origin of Earth’s Radioactivity**” (pages 379–433), during the flood, powerful electrical (piezoelectric) currents inside the fluttering crust released a gigantic flux of neutrons within the crust. That resulted in the production of a few thousand *new isotopes*—unusually light (or heavy) chemical elements, because they had fewer (or more) neutrons than normal.

Carbon-14. One isotope produced was carbon-14, which is radioactive. **It is decaying in your body a few thousand times each second.**⁴ What happens when a carbon-14 atom in your body suddenly decays and becomes nitrogen? *It’s not good.* That nitrogen bonds differently with other tissues, producing distortion (wrinkling/aging) at the atomic level. Also, if any carbon-14 in your DNA or RNA decays, the mutated gene will function differently or not at all. These effects age you very slightly every second. Which organs finally break down or become diseased will depend partially on the genetics you inherit. (The decay

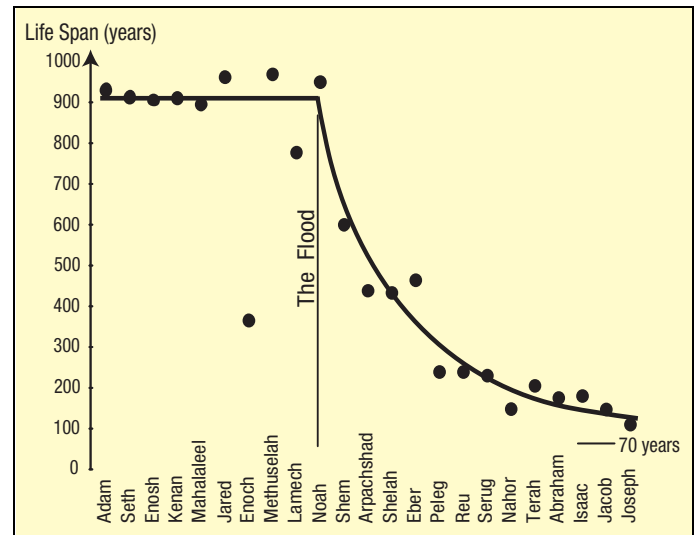

Figure 249: Declining Postflood Longevity. Notice the sudden downward trend in postflood life spans after of the flood. This type of downward declining curve (an exponential decay) strongly suggests that man’s environment underwent a drastic change which reduced human life spans.⁵

of potassium-40 in our bodies has similar consequences.⁶)

A previous frequently-asked question (pages 506–509) concerns radiocarbon dating and the rapid buildup of carbon-14 in the atmosphere beginning after the flood. The *negative exponential curve* in Figure 249 is a mirror image of the *positive exponential curve* (line C) in Figure 248 on page 507. The increase in postflood carbon-14 probably decreased longevity to a slight extent, but the sudden production of thousands of new isotopes during the flood (most of which were not radioactive) introduced a more important aging mechanism.

Misfolded Proteins. In the centuries after the flood, the thousands of new isotopes produced during the flood steadily worked their way out of the crust and into the biosphere. There they entered humans through their intake of food, liquids, and air—slowly degrading (or aging) cells by sometimes misfolding proteins. Here’s why.

Every cell in your body contains millions of *ribosomes*⁷—absolutely amazing and complex manufacturing plants that assemble your body’s proteins. These harmful isotopes you eat, drink, and inhale are sometimes incorporated into the 20 different types of amino acids that are brought into your ribosomes and hooked together (based on the instructions in your DNA) into long chains. When a chain exits a ribosome, the electrical charges on the chain and other complex effects fold it in multiple ways simultaneously. A fascinating animation of this complex folding process in a bacterium is shown at:

www.mrc-lmb.cam.ac.uk/ribo/homepage/movies/translation_bacterial.mov

A protein’s specific, three-dimensional shape determines what it does in your body. If the protein misfolds—due to light (or heavy) isotopes that either speed up or slow down an

overlapping fold, the proteins *external* shape may not fit into its intended tissue like a jig-saw piece fits into a jig-saw puzzle. If the *internal* configuration is wrong, two amino acids may be too far apart to function properly. Misfolded proteins produce diseases, such as Alzheimer's⁸ and Parkinson's.

In effect, those new (heavier or lighter than normal) isotopes were mild poisons that diffused and migrated out of the crust at a rate proportional to their concentration in the crust. They began entering the biosphere rapidly right after the flood, but leveled off centuries later. Therefore, **cells (and life spans) were degraded in an exponential decay pattern, immediately after the flood.**

Every second, isotopes produced during the flood are slowly aging us at the atomic level, so our organs deteriorate. Which of the thousands of new isotopes are most damaging and what repair mechanisms play a role are open questions.

Cancer. Cancer is the number one killer in the world. (Heart disease is number two.) Most cancers are caused by a currently unknown random effect that produces mutations when stem cells divide.

*Now in an eye-opening study published in **Science**, researchers report that the majority of cancer types are the result of pure chance, the product of random genetic mutations that occur when stem cells—which keep the body chugging along, replacing older cells as they die off—make mistakes copying the cells' DNA.*⁹

What might be driving that seemingly random effect? Each atom moving in your cells acquired a variable number of neutrons during the flood, and therefore will move slower than normal if it has extra neutrons or faster than normal if it has fewer neutrons. On rare occasions, those abnormal isotopes will foul up complex stem-cell divisions.

Date of Flood Based on Genetic Discoveries. Genetic studies give us the most likely date when these rapid mutation rates began—and therefore, a good estimate for the date for the flood: 3103 B.C.¹⁰ It is also remarkably close to 3290 B.C.—the most likely date for the flood based on astronomical information: [See **“When Was the Flood, the Exodus, and Creation?”** on pages 482–484.] The overlapping statistical uncertainties in each date mean that the dates are statistically indistinguishable.

These genetic studies were made possible because the cost to sequence human DNA has steadily dropped. This allowed the sequencing of 15,000 protein-coding genes in each of 2,440 individuals of European or African ancestry. It was discovered that humans carry a large number of extremely rare mutations, each of which has altered one of the bases in these 15,000 genes. (The genetic code is written with an alphabet of four characters, called *bases*.)

Because there are so many of these unique mutations in each of us, and each specific mutation is shared by so few people, the mutations have not had enough time to spread throughout the human population. Therefore, they must have begun recently. How

recently? Looking at mutations in people of European ancestry, the most likely beginning date is 3103 B.C. Looking at mutations *which are generally different* in people of African ancestry, the most likely beginning date is also 3103 B.C.¹⁰ Remarkable!

Scientists specializing in aging recognize some of this. Dr. Thomas Kirkwood, Director of Aging and Health at Newcastle University in England, writes:

Many scientists believe that the aging process is caused by the gradual buildup of a huge number of individually tiny faults—some damage to a DNA strand here, a deranged [misfolded] protein molecule there, and so on. This degenerative buildup means that the length of our lives is regulated by the balance between how fast new damage strikes our cells and how effectively this damage is corrected. The body's mechanisms to maintain and repair our cells are wonderfully effective—which is why we live as long as we do—but these mechanisms are not perfect. Some of the damage passes unrepaired and accumulates as the days, months and years pass by. We age because our bodies keep making mistakes.

*We might well ask why our bodies do not repair themselves better. Actually we probably could fix damage better than we do already. In theory at least, we might even do it well enough to live forever.*¹¹

While we may not know “why our bodies do not repair themselves better,” there is much we now know:

- ◆ The flood increased aging processes greatly.
- ◆ Thousands of new isotopes (heavy or light) produced during the flood are mixed with all that we eat, drink, and breathe. On rare occasions, these isotopes interfere with our very complex genetics and cellular machinery.
- ◆ At the atomic level, this damage occurs in a somewhat random manner, even among identical twins, because the potentially harmful isotopes we take into our bodies can become “bullets” that hit us in tiny but rapid versions of “Russian roulette,” each time a ribosome produces a misfolded protein.
- ◆ The potential damage during each roulette game is quite small; however, we each play thousands of these games a second. We, and all living things, are slowly aging.¹² (Note: *Aging is qualitatively different than radiation damage which produces deformities and lack of fitness.*)

These genetic disruptions (mutations) would have also occurred in the descendants of the animals on the Ark. Within a few generations, the differing characteristics of their offspring would multiply the number of species on earth today. This rapid speciation right after the flood is microevolution, not macroevolution.

Human death rates increase greatly with age, but death rates vary widely among animals.¹³ For example, desert tortoises have decreasing death rates as they age. Nevertheless, *the symptoms of aging* are remarkably similar among animals and humans: wrinkled skin, slowly deteriorating movements and sensory perceptions, duller colors, loss of muscle mass, cancers, slower learning, weakened immune

systems, and the buildup of amyloid plaques in brains. This is because the number of isotopes for each chemical element increased greatly during the flood, and every animal uses the same chemical elements (which no longer

have standard weights). Therefore, all animals accumulate misfolded proteins which explain these symptoms of aging, but the rates of accumulation and repair vary.

References and Notes

1. If the life spans of the postflood patriarchs (recorded in the Bible) had been mistranslated, randomly selected, or made up by someone with no knowledge of higher mathematics, a linear fit would be much more likely than an exponential decay.

Why was Noah's life span apparently unaffected by the postflood environment? For the first 600 years of his life, Noah did not live in the postflood environment. Only during the flood did the fluttering crust produce the harmful isotopes. It took many years for them to work their way into the biosphere and the food, water, and air we take into our bodies. Then, more years were required for sufficient damage to build up in Noah's already mature organs.

2. Some say a canopy, which shielded the earth from deadly radiation, collapsed during the flood, so lifespans decreased. If that were true, people living today at lower elevations and higher latitudes would be shielded by more atmosphere and should live longer. That is not the case. [See "Drop in Longevity" on page 518.]
3. Caleb E. Finch and Rudolph E. Tanzi, "Genetics of Aging," *Science*, Vol. 278, 17 October 1997, pp. 407–411.
4. Consider a person weighing 160 pounds (72,575 grams). About 18% of that individual's mass is carbon. Every 12 grams of carbon contains 6.022×10^{23} (Avogadro's number) carbon atoms. One carbon atom out of a trillion (10^{12}) is carbon-14 which has a half-life of 5,730 years. When carbon-14 decays, it becomes nitrogen-14. Therefore, a 160-pound human experiences 2,500 carbon-14 disintegrations every second!

$$\frac{72,575 \times 0.18 \times 6.022 \times 10^{23} \times 0.693}{12 \times 10^{12} \times 5,730 \times 31,556,736} = 2,500 \frac{\text{disintegrations}}{\text{second}}$$

Note: There are 31,556,736 seconds in a year, and 0.693 (the natural logarithm of 2) converts half-lives to rates of decay.

5. Lifespans in Figure 249 are based on the Hebrew (Masoretic) text. The Septuagint and Samaritan Pentateuch texts show a similar exponential decay, although the cumulative ages differ significantly.

Table 33. Time Spans vs. the Three Bible Manuscripts

Time Span (years)	Hebrew	Samaritan	Septuagint
From Adam to the Flood	1656	1307	2242
From the Flood to Abraham	290	940	1070

See Walter Russell Bowie, "The Book of Genesis," *The Interpreter's Bible*, Vol. 1 (New York: Abingdon Press, 1952), p. 143.

6. "The rates of disintegration of potassium-40 and carbon-14 in the normal adult body are comparable (a few thousand disintegrated nuclei per second)." <http://en.wikipedia.org/wiki/Carbon-14>.
7. "Every living cell contains millions of these complex

structures [ribosomes]." Georgina Ferry, "From Ribosome to Royal Society," *Nature*, Vol. 561, 6 September 2018, p. 32.

- ◆ "You could pack four thousand [ribosomes] in the width of a human hair. There were thousands of them in every cell, from bacteria to humans." Venki Ramakrishnan, *Gene Machine* (New York: Basic books, 2018), p. 14.
8. "AD [Alzheimer's disease] is therefore commonly characterized as a protein-misfolding disease." Sabrina Pospich and Stefan Raunser, "The Molecular Basis of Alzheimer's Plaques," *Science*, Vol. 358, 6 October 2017, 45.
 9. Alice Park, "Most Cancer Is Out of Our Control," *Time*, 19 January 2015, p. 22.
 - ◆ Christian Tomasetti and Bert Vogelstein, "Variation in Cancer Risk among Tissues Can Be Explained by the Number of Stem Cell Divisions," *Science*, Vol. 347, 2 January 2015, pp. 78–81.
 - ◆ Jennifer Couzin-Frankel, "The Bad Luck of Cancer," *Science*, Vol. 347, 2 January 2015, p. 12.
 10. "The maximum-likelihood time for accelerated growth [of these rare mutations (coding variations)] was 5115 years ago." Jacob A. Tennesen et al., "Evolution and Functional Impact of Rare Coding Variations from Deep Sequencing of Human Exomes," *Science*, Vol. 337, 6 July 2012, p. 67.

Note: 2012 A.D. is the date of the above quote. Therefore, 2012 A.D. - 5115 = 3103 B.C.

- ◆ "Large-scale surveys of human genetic variation have reported signatures of recent explosive population growth, notable for an excess of rare genetic variants, suggesting that many mutations arose recently. ... accelerated population growth began 5,115 years ago." Wenqing Fu et al., "Analysis of 6,515 Exomes Reveals the Recent Origin of Most Human Protein-Coding Variants," *Nature*, Vol. 493, 10 January 2013, p. 216.
- This second study by a different group confirmed the results of that by Tennesen et al., but base it on a much larger sample—6,515 individuals.
- ◆ Alon Keinan and Andrew G. Clark, "Recent Explosive Human Population Growth Has Resulted in an Excess of Rare Genetic Variants," *Science*, Vol. 336, 11 May 2012, pp. 740–743.
11. Thomas Kirkwood, "Why Women Live Longer," *Scientific American*, Vol. 303, November 2010, p. 35.
 12. Aging is not the same as our 20 years or so of development from conception to maturity, so the time required to become a mature adult has probably not changed too much. Therefore, people living before the flood spent a much greater percentage of their lives as productive, mature adults than we who live after the flood. Indeed, Noah had children after he was 500 years old. [See Genesis 5:32.]
 13. Susan Milius, "Aging's Wild Side," *Science News*, Vol. 190, 23 July 2016, p.26–30.

Have Planets Been Discovered Outside the Solar System?

Yes. At least 2650 exoplanets have been confirmed, and astronomers estimate our galaxy has “at least as many planets as stars: 100 billion.”¹ What has been learned from these discoveries does not imply that planets evolve or that life exists on such planets. Quite the opposite.²

The media and a few astronomers usually fail to explain important aspects of these discoveries. From 1963–2000, claims were made that planets had been found outside the solar system. Few details were given, so the general impression that planets evolve was reinforced and became textbook orthodoxy. While planets have been discovered, their characteristics contradict all theories proposed during the past 275 years for how planets evolved.³

These theories include: the nebular hypothesis by Emanuel Swedenborg (1734) and later refined by Immanuel Kant (1755) and Pierre-Simon Marquis de Laplace (1796), the planetesimal theory by Thomas Chrowder Chamberlin and Forest Noulton (1901), the tidal theory by James H. Jeans (1917), the accretion theory by Otto Schmidt (1944), the protoplanet theory by William Hunter McCrea (1960), the capture theory by Michael Woolfson (1964), and the solar nebular disk theory by Viktor Safronov (1972). New evolutionary theories are usually proposed when it is recognized that the prior theories do not work. Today, experts agree; no theory for the evolution of planets works.³

Temperatures on most of these exoplanets are too extreme for life.⁴ Besides, many other requirements must be met for life to exist, and most importantly, life is too complex to have evolved. [See pages 5–25 and “[Is There Life in Outer Space?](#)” on page 531.]

What were these false claims that planets had been discovered? In 1963, Peter van de Kamp announced that Barnard’s star wobbled, as if a planet orbited the star. Ten years later, other astronomers showed that the telescope wobbled, not the star. In 1984, major radio and television networks reported that astronomers at Kitt Peak National Observatory had discovered the first planet outside the solar system. Other astronomers, after months of searching, could not verify the claim. Two years later, the astronomers who made that “discovery” acknowledged that atmospheric turbulence probably fooled them, because even they could not find their “planet.” In 1991, British astronomers reported that a star, named Scutum, wobbled with a six-month cycle. They claimed, and the excited media announced, the discovery of the first planet outside our solar system. Later, these astronomers admitted their error. The Earth wobbled slightly, not the star.

On 19 May 1998, NASA announced, amid much fanfare, that the Hubble Space Telescope had made the first *direct* observation of a planet outside the solar system. An editorial in *Nature* criticized NASA’s premature announcement. “*One does not need to read between the lines to perceive a deep need within NASA for publicity.*”⁵ Two years later, the

astronomer making the “discovery” retracted her claim.⁶ What she thought was a planet was a star dimmed by interstellar dust. Other false alarms involved astronomers eager for publicity who joined with media eager to sell an exciting story. Misinformation resulted. Unfortunately, the media rarely retracts reports that are later disproven, and textbooks, which change slowly, have yet to catch up.

Several stars are surrounded by disks of gas and dust, which a few astronomers thought might be merging to form planets. Some of these astronomers also believe that finding such disks confirms the theory that planets evolve from gas and dust orbiting a star. However, it is now known that on rare occasions the outer envelope of a sunlike star can be ejected into a disk-shaped cloud.⁷

Since 2000, sophisticated techniques have identified more than 3,567 planets outside our solar system. One technique accurately measures a star’s wobble, indicating that a possible planet orbits that star. A second technique measures the slight but periodic dimming of a star, suggesting that a planet is passing between the star and Earth. Other planets have been detected based on the way their gravity bends light rays we see from a light source behind the planet. A few telescopes have directly spotted extremely large planets that are far from the glare of the stars they orbit.

What has been learned? As one astronomer wrote, these newly discovered planets “spell the end for established theories of planet formation.”³ How do these extrasolar planets contradict evolution theories? One planet has been found in a tight cluster of tens of thousands of stars that would disrupt the evolution of any planet. That cluster is also devoid of the heavy chemical elements thought necessary to evolve a planet.⁸ At least 30 separate planets each orbit a pair of suns whose constantly changing positions would disrupt any slow evolution of a planet.⁹ One planet has been repeatedly observed eclipsing each of the eccentric binary stars it orbits. The forty-nine experts who discovered this planet admit that they have no theoretical understanding for how such a planetary system could have evolved.¹⁰ One planetary system (having at least two planets) orbits a pair of suns!¹¹ A Jupiter-size planet has been found orbiting three suns! Its orbit is so close to one star (0.05 AU) that it would have been pulled apart and overheated before it could have evolved. Worse yet, two other stars orbit the first star at a distance of 12.3 AU. They would also prevent the planet from evolving.¹² Other planets orbit binaries in other strange configurations.¹³

Some planets are so near their star that they are losing mass too rapidly to have been planets for very long.¹⁴ Besides, their rocky cores would have melted before the planet’s evolution could begin.¹⁵ Others are too far from their star and the dust near the star needed to grow a planet. Also, their slow motion at those great distances would “scoop up” little dust. One extreme example is a planet that is 650 AU

from its star (650 times the Earth-Sun distance).¹⁶ That great distance may have resulted from the stretching of space during the creation week, as explained on pages 439–454.

If planets have evolved, friction from the gas and dust around a young star would have circularized each planet's orbit. Many extrasolar planets have very elongated and/or highly inclined orbits as opposed to the orbits of the planets in our solar system. A few planets orbit their star in directions opposite to the direction the star rotates.¹⁷ Neither elongated, nor tilted, nor retrograde orbits would evolve from swirling dust clouds.

Some relatively cool, “rogue” planets (not associated with any star) are being discovered wandering alone in deep space. Experts admit that, *“The formation of young, free-floating, planetary-mass objects like these is difficult to explain by our current models of how planets form.”*¹⁸

One extrasolar planetary system, called *Kepler-11*, consists of six planets orbiting in nearly the same plane. They are so close to their star that collisions and orbital perturbations should have quickly destroyed their compact, “flat” arrangement¹⁹—unless they are extremely young.

What is clear is that for both our solar system's planets and for the extrasolar planets, evolutionary explanations have been shattered. Unfortunately, hundreds of millions of people have been misled by claims that planets evolved. Even the “experts” who have been telling us these stories will now admit that they were wrong.²⁰

So what accounts for planets (solar and extrasolar)? They could have been created directly. A second possibility, explained on pages 439–453, is that planets formed from densely packed matter just before the heavens were stretched out.

References and Notes

1. Daniel Clery, “Planet Hunter Nears its End.” *Science*, Vol. 362, p. 275.
2. *“We’ve learned that we really don’t know what we’re talking about with respect to exoplanets: how they form, what their distributions are, anything!”* Gibor Basri, “Is Anybody Out There?” *Discover*, November 2010, p. 49.
3. *“The discovery of thousands of star systems wildly different from our own has demolished ideas about how planets form. Astronomers are searching for a whole new theory.”* Ann Finkbeiner, “Planets in Chaos,” *Nature*, Vol. 511, 3 July 2014, p. 22.
- ◆ *“With so little in common with the familiar Solar System planets, these newcomers spell the end for established theories of planet formation.”* Dan Falk, “Planet Formation,” *Nature*, Vol. 422, 17 April 2003, p. ix.
- ◆ *“All planetary systems were supposed to look like ours The planets we’re finding are in the wrong places! And their orbits are unlike anything anyone predicted. Now, that’s a warning. That tells you we don’t know how to predict what’s out there.”* William Borucki, as quoted by Tim Folger, “The Planet Boom,” *Discover*, May 2011, p. 39.
- ◆ *“Moreover, the predictions made by theoretical [evolutionary] models of solar system formation when confronted with observations of exoplanets, fail rather spectacularly.”* Frederic A. Rasio, “A Black Widow’s Best Friend?” *Science*, Vol. 333, 23 September 2011, p. 1712.
4. *“Most of the worlds we have found seem unlikely to support life [because of temperatures].”* Adam Frank, “How Nature Builds a Planet,” *Discover*, Vol. 26, July 2005, p. 30.
5. “Dangers of Publication by Press Conference,” *Nature*, Vol. 393, 4 June 1998, p. 397.
6. Ron Cowen, “The Planet That Isn’t,” *Science News*, Vol. 157, 22 April 2000, p. 271.
- ◆ Susan Terebey et al., “The Spectrum of TMR-1C Is Consistent with a Background Star,” *The Astronomical Journal*, Vol. 19, May 2000, pp. 2341–2348.
7. L. F. Miranda et al., “Water-Maser Emission from a Planetary Nebula with a Magnetic Torus,” *Nature*, Vol. 414, 15 November 2001, pp. 284–286.
8. *“Finally, it is possible that regardless of how many and where planets form, the dynamical perturbations experienced over the history of the cluster would be too disruptive to allow the survival of any planets . . .”* Steinn Sigurdsson et al., “A Young White Dwarf Companion to Pulsar B1620-26: Evidence for Early Planet Formation,” *Science*, Vol. 301, 11 July 2003, p. 195.
- ◆ *“The discovery of a giant planet amid a cluster of primitive stars is challenging one of astronomers’ pet notions. . . . [The planet would have to have been] born billions of years before most astrophysicists thought the universe had spawned the raw materials needed to make them.”* Robert Irion, “Ancient Planet Turns Back the Clock,” *Science*, Vol. 301, 11 July 2003, p. 151.
9. Ron Cowen, “One Star Better Than Two?” *Science News*, Vol. 169, 21 January 2006, p. 46.
- ◆ *“For a long time people didn’t believe there could be planets orbiting a pair of stars [because planets would not be able to evolve].”* William Borucki, as quoted by Andrew Grant, “William Borucki: Planet Hunter,” *Discover*, December 2012, p. 49.
10. *“Planetesimal formation around an eccentric binary is a theoretical challenge, because of the large collision velocities of particles that are stirred by the stellar binary.”* Laurance R. Doyle et al., “Kepler-16: A Transiting Circumbinary Planet,” *Science*, Vol. 333, 16 September 2011, p. 1606.
11. *“... close binary stars can host complete planetary systems.”* Jerome A. Orosz et al., “Kepler-47: A Transiting Circumbinary Multi-planet System,” *Science*, Vol. 337, 21 September 2012, p. 1511.
- ◆ *“It’s hard enough to imagine how you get one planet in the binary; now we have two.”* William Welsh, as quoted by Nadia Drake, “Exoplanet Pair Orbits Twin Suns,” *Science News*, Vol. 182, 6 October 2012, p. 12.

12. Maciej Konacki, "An Extrasolar Giant Planet in a Close Triple-Star System," *Nature*, Vol. 436, 14 July 2005, pp. 230–233.
 - ◆ "The discovery by Maciej Konacki of a giant planet in a system where the gravitational pull of a second star would disturb the planet's putative nursery will now place severe constraints on such [evolutionary] theories." Artie P. Hatzes and Günther Wuchterl, "Giant Planet Seeks Nursery Place," *Nature*, Vol. 436, 14 July 2005, p. 182.
 - ◆ "In July [2005] Caltech planetary scientist Maciej Konacki turned up a world with three suns in the constellation Cygnus. Finding that a planet could exist in a multiple-star system counter to theoretical expectations, 'will put our theories of planet formation to a strict test,' says Konacki." Jack Kelley, "Hunt for Another Earth Broadens," *Discover*, Vol. 27, January 2006, p. 26.
13. "Planets have been discovered in a variety of binary configurations. For example, about seven transiting circumbinary planets have been discovered in Kepler satellite data and two jovian planets have been found in binary systems using RV [radial velocity techniques]." A. Gould et al., "A Terrestrial Planet in a ~1-AU Orbit Around One Member of a ~15-AU Binary," *Science*, Vol. 345, 4 July 2014, p. 49.
14. Instead of gaining mass, as any evolving planet must do, one extrasolar planet is so close to its star that it is losing at least 10,000 metric tons of hydrogen a second. The rate of loss may be several orders of magnitude greater. [See A. Vidal-Madjar et al., "An Extended Upper Atmosphere Around the Extrasolar Planet HD209458b," *Nature*, Vol. 422, 13 March 2003, pp. 143–146.]
15. "More of these 'hot Jupiters' (orbiting within a tenth of the Earth-Sun distance) were soon found, making it clear that the principles underlying the formation of planetary systems needed some revision." Gibor Basri, "Too Close for Comfort," *Nature*, Vol. 430, 1 July 2004, p. 24.
16. Vanessa Bailey et al., "HD 106906 b: A Planetary-Mass Companion Outside a Massive Debris Disk," *The Astrophysical Journal Letters*, Vol. 780, 1 January 2014, p. L4.
17. "Cameron and colleagues recently studied 27 exoplanets and found that one-third had highly tilted orbits, including at least four that orbited backward." Stephen Ornes, "Wrong-Way Worlds," *Discover*, November 2010, p. 17.
18. M. R. Zapatero Osorio et al., "Discovery of Young, Isolated Planetary Mass Objects in the σ Orionis Star Cluster," *Science*, Vol. 290, 6 October 2000, pp. 103–107.
19. "Five of the six planets are packed into orbits smaller than that of Mercury, their paths almost perfectly aligned in the same plane. Astronomers are at a loss to explain how all the planets managed this configuration without crashing into each other." Andrew Grant, "The Planet Boom," *Discover*, May 2011, p. 34.
 - ◆ "The Kepler-11 planetary system is amazing,' said Jack Lissauer, a planetary scientist and a Kepler science team member at NASA's Ames Research Center, Moffett Field, Calif. 'It's amazingly compact; it's amazingly flat; there's an amazingly large number of big planets orbiting close to their star—we didn't know such systems could even exist.'" NASA Bulletin, "NASA's Kepler Spacecraft Discovers Extraordinary New Planetary System," 2 February 2011.
 - ◆ W. F. Welsh et al., "Dual 'Suns' Are No Novelty," *Nature*, Vol. 481, 12 January 2012, p. 147.
20. "Extrasolar planets have peculiar properties, and our understanding of how planets form, which was incomplete even before the new data became available, now looks even shakier." Dan Falk, "Worlds Apart," *Nature*, Vol. 422, 17 April 2003, p. 659.
 - ◆ "[Planets] form through processes that do not clearly fit into any of the standard theoretical models." Frank, p. 30.
 - ◆ Ron Cowen, "What Is a Planet: New Riddles beyond the Solar System?" *Science News*, Vol. 170, 2 December 2006, pp. 360–361.
 - ◆ "The astonishing close orbits and incredibly high planetary temperatures for the so-called hot Jupiters shattered the Solar System paradigm of planet formation and was the first surprising discovery of many in exoplanetary science." Drake Deming and Sara Seager, "Light and Shadow from Distant Worlds," *Nature*, Vol. 462, 19 November 2009, p. 301.

How Was the Earth Divided in Peleg's Day?

Genesis 10:25 states, and I Chronicles 1:19 repeats, "And two sons were born to Eber; the name of the one was Peleg, for in his days the earth was divided." Peleg lived a few centuries after the flood. Little else is known about him.

In what way was the earth divided? Here are three possibilities. Bible commentators mention only the first two.

- a. Languages suddenly multiplied at Babel and produced divisions among the people of the world. [See Genesis 11:1–9.]
- b. The continents were divided by continental drift, which began in Peleg's day.
- c. As explained by the hydroplate theory, all continents were connected soon after the flood because of greatly lowered sea levels.¹ Later, in Peleg's day, rising sea levels **divided the earth by water**.

Languages Divided in Peleg's Day? Scripture says, "the earth was divided." The Hebrew word for earth, *erets*, is also translated as "countries," "land," or "ground," so the land was divided, not people or languages. Besides, Peleg probably lived two generations *after* languages were multiplied at Babel²—and, according to Figure 247 on page 504, **100–339 years after the flood**.

Continents Broke and Began Drifting in Peleg's Day? If this happened, *what broke them apart, and what moved them?* It takes earth-shaking forces to break and move continents. Those who accept the plate tectonic theory believe that continents have broken frequently—geologically speaking. To stretch a thick slab of rock to the point where it finally breaks, requires, among other things,³ sliding one end of the block horizontally on its foundation

against enormous frictional force. [See the Technical Note on page 204.] Simultaneously, an additional force must stretch the slab, like a rubber band, until it breaks. Plate tectonics can't provide either gigantic force. Therefore, you can safely offer to move a continent (provide one force) if someone will break a continent (provide both forces).

Those who claim that continents broke and moved have not fully considered the forces and energy required. To open up the entire Atlantic in a few thousand years *by rock-on-rock sliding* would produce indescribable global violence and volcanic activity that left no geological or historical record. Among almost all cultures, ancient and modern, the only global catastrophe with a clear historical record is the flood.

If the continents broke apart, they should fit together better than they do. (Figures 52–54 on pages 120–121, show this.) The public has been misled for decades into believing that the continents fit against each other. Actually, four great map distortions were deliberately made, as Figure 52 on page 120 explains. Continents bordering the Atlantic fit much better next to the base of the Mid-Atlantic Ridge. The hydroplate theory explains why.

Rising Water Divided Continents in Peleg's Day? The Bible uses the Hebrew word *peleg* as a verb three times. Two usages, mentioned above, are translated simply as divided (Genesis 10:25 and I Chronicles 1:19). The third use is a division by water (Job 38:25). In the ten instances where *peleg* is a common noun, it always involves water. The *New American Standard Bible* translates it eight times as “streams,” once as “stream,” and once as “channels.” Therefore, *peleg* probably implies a division by water.

In English, we have the words *archipelago* (a sea having, or dividing, many islands) and *pelagic* (relating to or living in the sea). Pelagic sediments or deposits are sediments on the ocean floor. Pelagic frequently refers to life forms found in the sea. *Bathypelagic* means relating to or living in the deep sea. Also, the prefix *pelag* means sea.

Dr. Bernard Northrup, a Hebrew professor, has shown that *peleg* originally meant division by water.⁴ That meaning is embedded in all three language families of Noah's offspring, so its meaning probably preceded the multiplication of languages at Babel. Northrup states:

[Peleg, palag, or PLG] *often contains within it a reference to water. It is used to refer to a stream of water in Hebrew, Coptic, Ethiopic and in Greek. The root is used to refer to irrigation canals which carried the water throughout the farming land of Mesopotamia. However, an examination of the Greek usage (of the family of Japeth [one of Noah's three sons]) of the root letters PL and PLG clearly shows that in the majority of the instances this root was used of the ocean. ... It is used to mean: “to form a sea or lake,” “of places that are flooded and under water,” “of crossing the sea,” of “the broad sea” itself, of “being out at sea,” “on the open sea.” It is used of seamen and ships. The noun with the result suffix is*

used of “an inundation.” I continue: it is used of “a being at sea,” of “a creature of or on the sea,” of “one who walks on the sea,” of “running or sailing on the open sea,” of “a harbor that is formed in the open sea by means of sandbags,” and in many ways of “the open sea itself,” of “going to, into or toward the sea,” of “roving through the sea,” of “being sea-nourished,” of “turning something into the sea,” or “of flooding.” It is quite apparent that every Greek usage here involves the sea in some way.

Therefore, the earth was probably **divided by water** in Peleg's day. The hydroplate theory explains how and why.

At the end of the flood, the continental-drift phase and compression event pushed all of today's major mountain ranges up out of the floodwaters and opened up the Atlantic Ocean's basin which was initially 60-miles deep. Therefore, right after the flood, the waters drained onto what was the floor of the subterranean chamber, so **sea level was almost three miles lower than today**. This is confirmed by the *submarine canyons that have been gouged out almost 3 miles below today's sea level as well as table-mounts, and coral formations almost one mile below Eniwetok Atoll*. (Pages 111–192 provide more details.) Then, those newly formed mountains and the crushed and thickened, sediment-laden continents began sinking into the mantle. As mass was pushed down into the mantle, the mantle had to expand, and the easiest places for the mantle to rise were under the drastically lowered ocean floors. Therefore, sea level rose in compensation, eventually approaching today's level. That division of the earth's continents by rising sea level was in the days of Peleg who lived 100–339 years after the flood.

Before all but the last 300 feet of that rise, imagine how many migration paths existed for animals and man to populate today's continents and islands.⁵ God's commands (Genesis 9:1, 11:4–9) for humans and animals to populate the “whole earth” after the flood must have been doable. If, after the flood, sea level was where it is today, repopulating the “whole earth” would have been difficult, if not impossible, for those first receiving God's command. The wisdom and urgency of God's command are apparent when we realize that sea level was steadily rising. The “window of opportunity” for global migration was disappearing in Peleg's day.

From the genealogies listed on page 504, we see that Peleg lived five generations after Noah. Therefore, Peleg, or those who named him, may have been world travelers or explorers who discovered that Earth was being divided by rising water. Certainly, Noah's early descendants knew how to construct ships, because Noah and his three sons built the Ark. They would have had an explorer's curiosity when they realized how drastically the flood had changed the earth. Their long lifespans allowed them to pursue that curiosity and accumulate knowledge. This helps explain a remarkably accurate, authentic, and ancient map that shows islands now covered with water and the outlines of Antarctica—as it would look with no ice. [See Figure 246 on page 497.]

The Ice Age would have lowered sea level about 400 feet—almost enough to join all continents. But at the height of the Ice Age, Antarctica and all its coastlines would have been covered with ice. Therefore, the Ice Age cannot explain both the visible coastlines shown on the ancient map and interconnected continents. The flood accounts for both. (The hydroplate theory also shows how the flood produced the Ice Age.)

Conclusion. Strong linguistic and scientific arguments point to an earth being divided by rising water in the days of Peleg and suggest that our ancestors knew, a few centuries after the flood, of rising sea levels that would separate, or had separated, continents.

References and Notes

1. North America would join Asia at the Bering Strait. Except for very narrow channels of water, Australia would connect to Asia along a 1,000-mile-wide land bridge, Europe would join North America via Greenland, and Antarctica would touch South America.
2. Nimrod, who ruled at Babel, lived three generations after Noah (Genesis 10:8–10), while Peleg lived five generations after Noah.
3. The slab must first separate from its foundation before sliding and stretching can begin. At the extreme pressures pressing a continent onto its foundation, “fusing” would occur. Atoms on one side of the slab-foundation interface would bond with atoms on the other side in a crystalline, minimum-energy structure. Breaking that bond by some shearing action along a nearly horizontal plane would require *precise*, herculean forces. Plate tectonics does not address the three S’s: separation, sliding, and stretching.

Some speculate that large asteroid impacts or volcanic eruptions broke the continents. If such global disasters occurred, consider the vast collateral damage. Had today’s fragile life forms been anywhere on earth during such a catastrophe, they would not be here today. Also, deep rock is under extreme compression, which prevents spreading or breaking. These proposals have many other problems.
4. Bernard Northrup, “Continental Drift and the Fossil Record,” *Repossess the Land* (Minneapolis: Bible Science Association, 1979), pp. 165–166.
5. Legends of the Hopi Indians tell how their ancestors came to the Americas. *After a gigantic flood, their ancestors used many family-size rafts made from hollow reeds [bamboo] and “island hopped” for many years north and east to the Americas. The steep coastline (today’s continental slope, which the lower sea levels would have exposed) on the western coast of the Americas forced them northward until they could land. Rising water later drowned the chain of islands along their path.* [See Frank Waters, *Book of the Hopi* (New York: Penguin Books, 1963), pp. ix–27.]

This seems to describe the Mid-Oceanic Ridge in the Pacific as a major corridor to the northeast. It would explain many things, including why the earliest known settlers in the Western Hemisphere lived in Central and South America and came from southern Asia. [See Tom D. Dillehay, “Tracking the First Americans,” *Nature*, Vol. 425, 4 September 2003, pp. 23–24.] Today, bamboo, sometimes 12 inches in diameter, grows abundantly in southeast Asia and is used in building large, seagoing rafts. [See Bruce Bower, “Erectus

Ahoy: Prehistoric Seafaring Floats into View,” *Science News*, Vol. 164, 18 October 2003, pp. 248–250.]

- ◆ Lowered sea levels in the centuries after the flood also contributed to rapid migration in other parts of the world. The Austronesian family of languages includes those spoken by the peoples of Taiwan, Indonesia, Madagascar, New Zealand, Easter Island, the Philippines, Hawaii, and other Polynesian Islands—1,200 languages in all. Linguists, tracing the “ancestry” of each language, can see that the mother tongues originated in Taiwan and then radiated southwest, south, and east to the lands mentioned above—a span of 16,000 miles. [See R. D. Gray et al., “Language Phylogenies Reveal Expansion Pulses and Pauses in Pacific Settlement,” *Science*, Vol. 323, 23 January 2009, pp. 479–483.]

Improved means of travel—from rafts to canoes to outriggers—accompanied these outward migrations. Consequently, the vocabulary describing these innovations expanded with this radiation from Taiwan. [For linguistic details, see Jared M. Diamond, “Taiwan’s Gift to the World,” *Nature*, Vol. 403, 17 February 2000, pp. 709–710.]

Ancient DNA from the remains of four of the earliest settlers (who lived 2,700–3,100 years ago) on south Pacific islands closely matches the DNA of today’s southeast Asians. Because, that DNA does not match the DNA of people living in intermediate locations, the first settlers in the South Pacific, appear to have traveled great distances without mixing with peoples in between. [See Pontus Skoglund et al., “Genomic Insights Into the Peopling of the Southwest Pacific,” *Nature*, Vol. 538, 27 October 2016, pp. 510–513.]

Migrations are also traced by studies that identified mutations in a common bacterium in human intestines. [See Yoshan Moodley et al., “The Peopling of the Pacific from a Bacterial Perspective,” *Science*, Vol. 323, 23 January 2009, pp. 527–530.] Also, pots, tools, bones, and farming methods show that the outward expansion happened in several surges only a few thousand years ago.

Lowered sea levels after the flood reduced the distances vessels had to travel, because most of these lands, which are today islands, would have been connected or nearly connected. As sea levels rose and lands shrank to become islands, the waterways separating the islands expanded. Commerce and travel would have continued between many of these formerly connected lands. Without this understanding, we might think that ancient peoples survived long, dangerous voyages and just happened to land on distant islands.

Did a Water Canopy Surround Earth and Contribute to the Flood?

Isaac Vail (1840–1912) first proposed the canopy theory in 1874.¹ He believed that a canopy formed millions of years ago as the Earth evolved from a molten state. Vail supported his case primarily by ancient mythology. In his opinion, this included Genesis 1:6–8a, which states:

*Then God said, “Let there be an expanse in the midst of the waters, and let it separate waters from waters.”
And God made the expanse, and separated the waters which were below the expanse from the waters which were above the expanse; and it was so.
And God called the expanse heaven.*

Notice that these verses do not explicitly say that a canopy surrounded Earth.

Vail’s canopy was a vapor cylinder surrounding the Earth but open at the poles. Since then, many people have recognized problems with Vail’s canopy and have proposed variations. These usually involved a thin, spherical shell of water—as either a liquid, gas (a vapor), or solid (ice particles or an ice shell). As we will see, each variation has serious biblical and scientific problems. In fact, canopy theories “do not hold water.” Consequently, canopy theories have caused misunderstandings of the clear teachings of Genesis 1:6–8a, the structure of the pre-flood Earth, the flood, and Earth’s geological features. But first, what are the standard arguments for a canopy?

Arguments for a Canopy—and Brief Responses

The Source of the Flood Water. *“If all the water in the Earth’s atmosphere were to condense, only an average of one inch of rain would fall. Therefore, the Genesis flood raises two common questions: Where did so much flood water come from, and where did it all go? A canopy partially answers the first question.”*

Response: No canopy theory claims to provide all the water for a global flood. Nor does any canopy theory explain where the water went after the flood. Somehow transporting this water back into outer space or suddenly forming deep ocean basins after the flood is hard to imagine or explain. However, the phrase “the fountains of the great deep” (Genesis 7:11) implies that the flood water came from subterranean sources. To learn where the water went after the flood, see pages 111–151.

Many have rejected the Genesis flood account because they could not imagine where the flood water, which covered all pre-flood mountains, went. Canopy theories have contributed to this rejection of the flood account.

Drop in Longevity. *“Radiation from outer space may cause people to age. If so, a pre-flood canopy might have shielded people from this aging process. Perhaps that is why life spans before the flood were about 900 years.”*

Response: If radiation from space reduced life spans, we would expect an immediate drop in longevity after the flood. Life spans did drop, but for 12 generations after the flood, human longevity remained much higher than today. [See [Figure 249 on page 510](#).] Even Noah lived 349 years after the flood. Some argue that perhaps radiation damage accumulated genetically over many generations. Few, if any, canopy proponents have proposed specifically what type of harmful radiation it was, how it reduced longevity so much without causing massive deformities and genetic diseases, why longevity leveled off at about 70 years instead of continuing to deteriorate, or how to test the proposed mechanism.

Most proposals for this drop in longevity are testable, but seldom tested. One test, which might have shown that cosmic or solar radiation reduces longevity, failed. Mice were raised in deep caves, shielded from both types of radiation. Neither those mice nor their offspring lived longer than other mice.² Also, if radiation from outer space accelerated aging, then living at a lower elevation, where one is protected by a thicker blanket of atmosphere, should increase longevity. No such effect is known.³ (At sea level, our atmosphere has the same shielding effect as 3 feet of lead.)

Joseph Dillow’s book, *The Waters Above*, is probably the most complete, accurate, and up-to-date defense of any canopy theory. After explaining other problems with the “longevity claim,” Dillow concludes, “So it appears that canopy theorists have been in error when they appealed to the shielding effect of the canopy as a direct explanation for antediluvian longevity.”⁴ Dillow also states, “We readily admit that Genesis **does not** teach the existence of a pre-Flood vapor canopy.”⁵ [emphasis in original]

My attempt to explain why people lived to be about 900 years old before the flood is given on pages 510–512.

A Uniformly Warm Climate. *“A canopy may have given the Earth a uniformly warm climate. This might explain why fossils of temperate animals and plants (such as dinosaurs and large trees) are found in Antarctica and on islands inside the Arctic Circle.”*

Response: At the end of the flood, mountains were suddenly pushed up. This imbalanced (and rolled) the Earth, shifted the poles, and brought temperate regions to today’s polar regions. [For details see [page 136](#) and [Endnote 84 on page 148](#).] Also, during the global flood, some plants and animals may have floated to today’s polar latitudes where they were later fossilized.

Even if a canopy produced a warm polar climate, it would not satisfy another requirement for lush vegetation—sunlight in the winter. Polar nights are six months long, and when the Sun does shine, it is always low in the sky.

How could large trees and dinosaurs (requiring long food chains) survive, let alone thrive, during the long polar night?

Despite much speculation, no one knows what temperatures would exist under a canopy. Today, even experts disagree on the extent to which carbon dioxide warms the Earth. Think how much more difficult it is to determine the warming, thousands of years ago, under a canopy of unknown thickness, reflectivity, content, and height above the Earth.

Venus. “We see canopies on other planets, such as Venus.”

Response: Some planets have atmospheres, but none have a canopy. An atmosphere has contact with its planet, but a canopy is a distinct shell above the planet’s atmosphere. Venus is shrouded by a thick, opaque atmosphere, consisting primarily of carbon dioxide (96.5%), nitrogen (3.4%), and traces of other gases. Venus does not have a layer of water, or any other relatively heavy substance, above its atmosphere.

Genesis 7:11–12. *A lot of rain fell from somewhere. Genesis 7:11–12 states that “the floodgates of the sky were opened. And the rain fell ...” Doesn’t this imply a canopy?*

Response: If it did, similar canopy interpretations should predate Vail’s in 1874. Where are they? Quite often it is hard to see alternatives once we have learned “the accepted explanation.”

Actually, Genesis 7:11–12 says that “all the fountains of the great deep burst open, and the floodgates of the sky were opened. And the rain fell ...” Later, Genesis 8:2 states “the fountains of the deep and the floodgates of the sky were closed, and the rain from the sky was restrained.” These events were probably in cause-and-effect order. That is, the fountains of the great deep caused extreme, torrential rain. Once the fountains stopped, this violent rain ended. Then milder, more normal, rain fell. In other words, “the rain from the sky was restrained.”

A cause and effect sequence is also given in Proverbs 3:19–20: “The Lord by wisdom founded the Earth; by understanding He established the heavens. By His knowledge the deeps were broken up, and the skies dripped with dew.” The same Hebrew word, *baqa* (בָּקַע), is used for “broken up” and “burst open” in Proverbs 3:20 and Genesis 7:11. *Baqa* describes a violent and complete splitting, sometimes of the Earth’s crust (Numbers 16:31, Micah 1:4, Zechariah 14:4). Isaiah 34:15 and 59:5 use *baqa* to describe the breaking of an egg shell by internal pressure as a baby bird exits. This aptly describes events of the hydroplate theory—the globe encircling rupture splitting the Earth’s crust by internal pressure and releasing fountains of water.

The Hebrew word, *matar*, means normal rain. Violent rain is *geshem* (used in Genesis 7:11 and 8:2). It is sometimes accompanied by high winds and huge hailstones that

can destroy mortared walls (Ezekiel 13:11–13). The hydroplate theory (pages 111–151) explains this sequence in more detailed, physical terms. We have failed to appreciate the explosiveness, magnitude, and power of “the fountains of the great deep.” [See “The Origin of Earth’s Radioactivity” on pages 379–433.]

Scientific Arguments Opposing a Canopy

The Pressure Problem. A canopy holding only 40 feet of liquid water, or its equivalent weight of vapor (steam) or ice, would double the Earth’s atmospheric pressure—making oxygen and nitrogen toxic to many animals, including humans.⁶ This is why most vapor canopy theories limit the thickness of water in their canopy to less than 40 feet.

For a vapor canopy holding this amount of water, the high pressure at the canopy’s base would require that the temperature at the base exceed a scorching 220°F. Otherwise, the vapor would condense into a liquid. A vapor canopy whose base had that temperature would radiate large amounts of heat to the Earth’s solid surface. People, plants, and animals would absorb so much heat from all directions above that life might not survive.⁷ Those who believe that a vapor canopy would produce a globally mild climate have overlooked this detail.

Maintaining a canopy’s 220°F temperature at night, or worse yet, at the poles during the coolest season, adds a further difficulty. Yes, there were seasons before the flood. [See Genesis 1:14.]⁸

The Heat Problem. All canopy theories⁹ have another major heat problem. The larger the canopy, the greater the heat problem.

A Vapor Canopy. Each gram of water vapor (steam) that condenses to a liquid releases about 539 calories of heat. If 6.22×10^{21} grams of water fell from a vapor canopy (enough to form a layer of water only 40 feet thick around the world), the temperature of the water and atmosphere would, as a first approximation, rise 810°F (or 450°C).

$$\frac{539 \frac{\text{cal}}{\text{gm}} \times 6.22 \times 10^{21} \text{ gm}}{\left(5.1 \times 10^{21} \text{ gm} \times 0.242 \frac{\text{cal}}{\text{gm}^\circ\text{C}} \right) + \left(6.22 \times 10^{21} \text{ gm} \times 1.0 \frac{\text{cal}}{\text{gm}^\circ\text{C}} \right)} = 450^\circ\text{C} = 810^\circ\text{F}$$

where 5.1×10^{21} grams is the mass of the atmosphere, and 0.242 and 1.0 are the calories needed to raise one gram of air and one gram of liquid water 1°C (respectively). Unbearable temperatures remain even after we expand this analysis to include every scientifically conceivable way to remove this heat.¹⁰

Also, **40 feet of rain would not produce a global flood, whose waters cover all of Earth's mountains.**

A Liquid or Ice Canopy. For liquid or ice particles to remain in space above the Earth's atmosphere, they must orbit the Earth. Anything in a near-Earth orbit must travel about 17,000 miles per hour (760,000 cm/sec). (As stated earlier, a layer of water only 40 feet thick contains 6.22×10^{21} grams of water.) Just as a spacecraft generates great heat as it reenters the atmosphere, orbiting liquid or ice particles would release all their kinetic energy as heat as they reenter the atmosphere. That amount of heat is

$$\frac{1}{2} \times 6.22 \times 10^{21} (760,000)^2 \times 2.39 \times 10^{-8} = 4.29 \times 10^{25} \text{ cal}$$

where 2.39×10^{-8} converts the units to calories. This heat would raise the atmosphere's temperature

$$\frac{4.29 \times 10^{25} \text{ cal}}{\left(5.1 \times 10^{21} \text{ gm} \times 0.242 \frac{\text{cal}}{\text{gm}^\circ\text{C}} \right) + \left(6.22 \times 10^{21} \text{ gm} \times 1.0 \frac{\text{cal}}{\text{gm}^\circ\text{C}} \right)} = 5,700^\circ\text{C} = 10,000^\circ\text{F}$$

Even if a canopy began with the coldest ice possible (absolute zero) or if some heat were transferred elsewhere, insufferable heat would remain.¹¹

A similar problem exists if this ice were part of a spinning shell surrounding the Earth. A rapidly-spinning shell, providing enough centrifugal force to balance the gravitational force as much as possible, would still have too much kinetic energy. Once the shell collapsed, that energy would become scalding heat, enough to "roast" all life on Earth.

The Light Problem. A canopy having only 40 feet of water—in any form—would reflect, refract, absorb, or scatter most light trying to pass through it.

Starlight. People living under a 40-foot-thick canopy could see stars only if they were directly overhead, so their light had the shortest path through a canopy. Before the flood, people presumably could see stars, because stars were created for a purpose: "for signs, and for seasons, for days and years" (Genesis 1:14). Stars would achieve their purpose only if enough stars could be seen to identify seasonal variations. Therefore, one needs to see large star patterns, such as constellations—not just a few stars directly overhead. By looking through a "keyhole" into the night sky, it is questionable whether one could have seen, recalled, and distinguished seasonally shifting star patterns through the filter of a 40-foot-thick canopy, even on a moonless night.

Sunlight. A canopy would also reflect and absorb considerable sunlight. How then could many tropical plants that require much sunlight today, have survived for centuries under a preflood canopy?

The Nucleation Problem. To form raindrops, microscopic particles, called *condensation nuclei*, must be present to initiate condensation. However, falling rain sweeps away these nuclei and cleans the atmosphere. This reduces further condensation. The initial rain from a vapor canopy would actually "choke off" further rain production.

Some claim that during the flood, volcanic eruptions ejected condensation nuclei into the upper atmosphere. Never explained is why volcanic eruptions suddenly began globally, then distributed nuclei throughout the atmosphere for about 40 days. Volcanic eruptions, instead of contributing to the flood, require special conditions that seem to be a consequence of the flood. [For an explanation, see pages 118 and 134.]

The nucleation and heat problems greatly limit the rate and amount of rain that can form by condensation. It seems more likely that "geshem rain" and a global flood was produced by the powerful jetting of the "fountains of the great deep," which caused torrential rain for "40 days and 40 nights."¹²

The Greenhouse Problem. While sunlight can pass through glass into a greenhouse, heat in a greenhouse has more difficulty radiating back out through the glass. This greenhouse effect traps heat inside the greenhouse, raising its temperature. All canopy theories have a huge greenhouse problem.

Also, as temperatures under a canopy rose, more water would evaporate from the Earth's surface, especially its oceans. More water vapor in the air means a greater greenhouse effect, a warmer atmosphere, and even more evaporation. This cycle would feed on itself, producing "a runaway greenhouse effect." For example, Venus' atmosphere has experienced a runaway greenhouse effect. Venus is about 700°F hotter than one would expect based on its distance from the Sun. The greenhouse effect increases Earth's average temperature by about 60°F.

For 36 years, the Institute for Creation Research (ICR) was the strongest advocate of a vapor canopy. But in 1998, ICR wrote that a strong greenhouse effect would exist under a vapor canopy, raising "surface temperatures as high as 400°F." However, if many variables were chosen in the most favorable way for a vapor canopy, "the water content of a canopy could be as much as [no more than] three feet of liquid water without the surface temperature reaching temperatures which would destroy life on the Earth."¹³ Actually, their study shows that surface temperatures would be unbearable if a canopy were only 4 inches thick.

The Support Problem. What supported the canopy?

A Vapor or Liquid Canopy. A vapor canopy would rapidly mix with the atmosphere, just as steam above a kitchen stove quickly mixes with air. Once the water vapor contacted the Earth's surface, it would condense. A liquid canopy would quickly evaporate and then diffuse through the atmosphere. Neither type of canopy could have survived for the many centuries before the flood.

An Ice Canopy. A pure ice canopy would vaporize into the vacuum of space, just as dry ice vaporizes at atmospheric temperature and pressure. Furthermore, ice is structurally weak. An ice shell could not withstand tidal stresses or meteoritic, cometary, or asteroidal impacts. A spinning ice shell could not withstand the powerful centrifugal forces at its equator and the crushing gravitational forces along its spin axis.

The Ultraviolet Problem. Ozone in Earth's upper atmosphere blocks the Sun's destructive ultraviolet light, but a canopy surrounding the atmosphere would be exposed to ultraviolet light. Therefore, water in a canopy would dissociate into hydrogen and oxygen, effectively destroying the canopy.

Final Thoughts. Could there have been a canopy? Perhaps, in one of two ways. First, one could minimize most of these scientific problems by assuming the canopy was thin, maybe inches thick. The thinner the canopy, the less severe most problems become. (Notice, the support and ultraviolet problems remain.) But what function would the canopy perform, and what hard, scientific evidence—not speculation—is there for claiming that a thin canopy could perform that function? Certainly, a thin canopy would not contribute to a global flood—the reason most people accepted the canopy in the first place.

Second, one could also dismiss each of these scientific problems by saying that God performed a miracle. That may be true. Certainly, He can; He has; and He sometimes does. However, miracles should not be proposed to “prop up” a scientific theory. (Some evolutionists mistakenly believe that this is how creation science works.) As one sees more and more “miracles” required by canopy theories, their plausibility decreases, and the need for an alternate explanation increases.

An Alternate Interpretation

Let us now consider another interpretation of Genesis 1:6–8a and related verses:

The word *expanse* (*raqia*) is used nine times in Genesis, all in the creation account, chapter 1. The first four uses are distinguished from the last four, to minimize confusion. Following each of the last four uses (in

Genesis 1:14–20) is the phrase “of the heavens.” Clearly, from the context, “expanse of the heavens” means sky, atmosphere, outer space, or heaven. However, the first four uses of “expanse,” in Genesis 1:6–7, do not use the phrase “of the heavens.” That expanse was Earth’s crust. Surface waters (oceans, seas, lakes, and rivers) were above this crust, and subterranean waters were below. The subterranean waters burst forth, producing the “fountains of the great deep” and the global flood.

Repetition of the phrase, “of the heavens” further helps us distinguish between the last four uses and the first four uses. The more complex middle, or fifth, usage of the word “expanse” will be discussed on page 522.

Pages 488–493 and 469–475 contain other support for this interpretation of *raqia*. Psalm 136:5–9, a song of thanks to God, deserves a special comment as well. It describes three sequential events: (1) the heavens are made, (2) **the earth is spread out above the waters**, and (3) the Sun, Moon, and stars were made. This sequence is similar to the creation events of *Day 1*, *Day 2*, and *Day 4*. If the proposed interpretation is correct, then Psalm 136:5–9 precisely parallels the creation events of *Days 1*, *2*, and *4*.

Several ancient extrabiblical writings also state that the Earth's crust, when first created, divided liquid waters above from liquid waters below.¹⁴

If this picture of the newly created Earth is correct, then it seems worthy of inclusion in the brief creation chapter of Genesis 1. However, if “*the waters above*” refers to a canopy containing less than one-half of 1% of the Earth's water, then why would one creation day and almost 10% of the creation chapter be devoted to it?

Key Hebrew Words

To understand Genesis 1:6–8a better, we will study the key words in bold below.

*Then God said, “Let there be an **expanse in the midst of the waters**, and let it **separate waters from waters**.” And God made the **expanse**, and **separated the waters** which were below the **expanse** from the **waters** which were above the **expanse**; and it was so. And God called the **expanse** heaven.*

Waters (*mayim*). This word means a liquid water, not a vapor or solid.¹⁵ Had the water in Genesis 1:6–8 been a vapor, cloud, mist, or ice, other Hebrew words would have been more appropriate. For example, ancient Hebrew had six words for “cloud.”

II Peter 3:5–6 also implies that this is liquid water. Peter used the same Greek word (ὕδωρ) to describe both the **liquid** water that flooded the Earth and the water out of which the Earth formed, an obvious reference to Genesis 1:6–7. **Liquid** water was both above and below the

expanse, which contradicts the vapor or ice canopy ideas but is consistent with the “expanse = crust” interpretation.

Separate (*badal*). This word implies a sharp division. Furthermore, the generally untranslated preposition “*ben*,” associated with “*badal*,” means “between.” It suggests an ordering (water, expanse, water) with no overlapping or gaps. Interfaces are also implied on each side of the expanse.¹⁶ These meanings oppose a vapor, liquid, or ice particle canopy lying above the atmosphere, because atmospheric gases would mix with the canopy.

In the Midst of (*tavek*). This word means between, within, among, inside, etc. Sometimes it means “to bisect” or “in the center of.” The respected Jewish scholar, Cassuto, in commenting on Genesis 1:6–7, stated, “It is true that in the Pentateuch, too, reference is made to the division of the primeval world-ocean into two halves, situated one above the other, ...”¹⁷ [See also Genesis 15:10.] Rabbi Solomon Yitzchaki, in his famous eleventh century *Rashi Commentary*, stated that the expanse was “in the exact center of the waters.”¹⁸ As we have seen, canopy theories place less than one-half of 1% of the Earth’s water above the expanse and the rest below. (This is necessary to reduce the problems associated with heat, light, and pressure mentioned earlier.) Would it not seem strange to say that your scalp is “in the midst of” your body? According to the hydroplate theory, the crust of the preflood Earth approximately bisects Earth’s liquid waters.

Heaven (*shamayim*). “Heaven” had a variety of meanings in ancient Hebrew, as it does in modern languages. Moses used *shamayim* to describe outer space (Genesis 26:4), the atmosphere (Genesis 27:28), where God dwells (Deuteronomy 26:15), where angels dwell (Genesis 28:12), and the source of blessings (Genesis 49:25). The context in which *shamayim* is used is important to understanding its specific meaning.

Expanse or Firmament (*raqia*). The key Hebrew word in Genesis 1:6–8a is *raqia* (רָקִיעַ). It is translated “firmament” in the King James Version and “expanse” in most Hebrew dictionaries and modern translations. While its original meaning is uncertain, its root, *raqa* (רָקַע), means to spread out, beat out, or hammer as one would a malleable metal. It can also mean “plate.” This may explain why the Greek Septuagint translated *raqia* 16 out of 17 times with the Greek word *stereoma* (στερέωμα), which means “a firm or solid structure.” The Latin Vulgate (A.D. 382) used the Latin term “firmamentum,” which also denotes solidness and firmness. So, the King James translators in A.D. 1611 coined the word “firmament.” Today, “firmament” is usually used poetically to mean sky, atmosphere, or heavens. In modern Hebrew, *raqia* means sky or heavens. However, originally it probably meant something solid or firm that was spread out. Indeed, Isaiah 42:5 says the earth was “spread out.”

Finally, if *raqia* were related to a canopy, it seems strange that other Hebrew words, often translated as “canopy,” were not used in Genesis: *sukkah* (Psalms 18:11 and II Samuel 22:12), *chuppah* (Isaiah 4:5), and *shaphrur* (Jeremiah 43:10).

Genesis 1:8a — Two Interpretations

Why then, does Genesis 1:8a state, “And God called the expanse heaven”? Here are two interpretations:

- “The expanse” meant the atmosphere or outer space.
- “The expanse” meant “heaven”—where God dwelt—the original paradise. Recall that God “walked” and “talked” with Adam (Genesis 3:8–9), so heaven was originally on the Earth—on the Earth’s crust.

If “heaven” meant atmosphere or outer space, then the Septuagint and Vulgate translators incorrectly associated solidness with it. Notice also that the similarities of *raqia* (רָקִיעַ) with *baqia* (בָּרָקִיעַ) and *raqa* (רָקַע) support the second interpretation. [See page 523.] If *raqia* (expanse or firmament) always means atmosphere or outer space, five questions, or apparent textual contradictions, arise.

Question 1: Why was the word *raqia* followed by the phrase “of the heavens” in Genesis 1:14, 15, 17, and 20? That would be redundant.

Question 2: If *raqia* implies a canopy, why wasn’t one of the three Hebrew words that clearly means “canopy” used?

Question 3: Genesis 1:1 says that the heavens were created on the first day.¹⁹ However, if *raqia* always means “heaven” (atmosphere or outer space), then Genesis 1:8a says heaven was created on the second day. Also, Genesis 1:8a defines heaven *after* the word “heavens” was first used in Genesis 1:1. Normally, a word’s meaning is understood from the context of its first usage.

Question 4: Genesis 1:9 states, “Let the waters below the heavens be gathered into one place, and let the dry land appear.” Obviously, these are Earth’s surface waters. If “heaven” meant atmosphere or outer space and if “expanse” meant a canopy surrounding the Earth, why would Genesis 1:9 not read, “Let the waters *below* be gathered into one place”? That would have been sufficient, clear, and consistent with the phrasing of Genesis 1:7, which relates the water’s two locations to the expanse. It would also make clear that the expanse (*raqia*) is above—not below—the surface waters. Instead, the text reads, “Let the waters below *the heavens* be gathered into one place.” The words “the heavens” apparently were added to make clear that *surface* waters were gathered into one place.

Question 5: Genesis 1:14 says the Sun, Moon, and stars (which fill the universe) were placed *in* the *raqia* of the heavens, and Genesis 1:7 says liquid water was placed *above* the *raqia* (as opposed to the *raqia* of the heavens).

What Does “*Raqia*” Mean?

The Hebrew word *raqia* is usually translated “expanse” or “firmament.” When it is directly followed by “of the heavens” it means atmosphere, sky, outer space, or heaven. However, when *raqia* stands alone, it means the Earth’s crust. The Hebrew words most similar to *raqia* (רָקִיעַ) are its root, *raqa* (רָקַע), *baqia* (בָּרַקַע), and *baqa* (בָּקַע). Each describes a pressed-out solid. For example, *raqa* is used in Numbers 16:38 and 16:39 when metal vessels were hammered (*raqa*) or *pressed out* into sheets for plating the altar.

In 1890, James Strong published a catalogue of all meanings of every word in the Bible. He counted the frequency of each Hebrew and Greek word’s specific English translation. For example, the Hebrew word *raqa*, the 7554th word in Strong’s Hebrew dictionary, is translated in the *New American Standard Bible* as “hammered out” twice, “spread out” three times, etc. Difficult-to-translate words can be better understood by studying all usages, contexts, and similar words.

The King James translators translated *raqia* as *firmament*, because they correctly saw it involved something firm. However, they did not know its specific meaning when Genesis was written. *Raqia* is obviously important, because the second creation day centered around it, just as the third day dealt with plants, and the fourth day with heavenly bodies. What was the *raqia*? It has been one of the most mysterious words in the Bible.

By studying English meanings of *raqa*, *baqa*, and *baqia* in [Table 34](#), one can see that atmosphere, sky, outer space, and heaven do not relate to *raqia*. Instead, we get a picture of **a hammered-out, or pressed-out solid**.²⁰

Why was the crust a pressed-out solid, and why was that important for all life that God would place on Earth in the following four creation days? Elsewhere in this book, you will see that before the flood the gravity of the Moon and,

Table 34. All Biblical Meanings of Words Related to *Raqia*

		PREFIX (STEM)	
		baq	raq
SUFFIX	a	<i>baqa</i> (Strong’s #1234): breached (3), break forth (1), break into (1), break open (1), break out (3), break through (1), breaks forth (1), broke through (2), broken into (2), breaks open (1), broken up (1), burst (2), burst open (1), cleave (1), dashed to pieces (1), divide (2), divided (3), hatch (2), hews (1), invaded (1), make a breach (1), rip up (1), ripped open (2), ripped up (1), shook (1), split (7), split open (1), splits (1), tear (1), tore (2), torn (2)	<i>raqa</i> (Strong’s #7554): beaten (1), hammered out (2), plates (1), spread out (3), spreading out (1), stamp (1), stamped (2) For usage and context see Ex 39:3; Num 16:39; II Sam 22:43; Job 37:18; Ps 136:6; Is 40:19, 42:5, 44:24; Jer 10:9; and Ezek 6:11, 25:6.
	i	<i>baqia</i> (Strong’s #1233): breaches (1), fragments (1) For usage and context see Is 22:9 and Amos 6:11.	<i>raqia</i> (when not followed by “of the heavens”): Traditional Interpretation: atmosphere, outer space, sky, heaven Proposed Interpretation: a pressed-out solid, such as pillars

to a lesser extent, the Sun, produced *tidal pumping* by continually pressing out the crust in the subterranean water chamber. That, in turn, generated gigantic amounts of heat that daily, by an ingenious heat-transfer system, evaporated some ground water that was slightly below the Earth’s surface. (Although heat from the subterranean chamber was transferred up through the entire crust, the subterranean chamber’s water never mixed with Earth’s ground or surface water.) The evaporated ground water, referred to as a mist in Genesis 2:6, watered the pre-flood Earth daily, giving animals, plants, and humans, a uniform amount of pure water. This will become clear after reading the “**Hydroplate Overview Chapter**” (pages 110–151), “**Did It Rain before the Flood**” (pages 475–479), and “**Tidal Pumping**” on pages 471 and 595–596. Notice that the “very good,” pre-flood Earth would not have experienced droughts or local floods.

Does this mean that the *raqia* is the universe, and liquid water surrounded the universe?²¹

After struggling to understand Genesis 1:8a for 30 years, I described several possible interpretations of Genesis 1:8a in the 7th edition (2001) of this book. In 2005, I received independent letters from two pastors proposing an explanation.²² Before Adam’s fall, Earth was a paradise; in a sense, it was “heaven on Earth.” Therefore, God called the firmament (Earth’s crust) heaven. (*Notice: God did not call heaven “the firmament.”*) Each pastor provided different biblical reasons for his view, but both maintained that our difficulty in understanding Genesis 1:8a results largely from our inability to imagine the original paradise. If man had not fallen, no one would have difficulty with the fact that God called the Earth “heaven.”

Confirmation of this is in Randy Alcorn’s outstanding book, *Heaven* (2004).²³ His case is so detailed, voluminous, and strong that any attempt to summarize it here would not do justice to his work. As Alcorn points out, nonbiblical stereotypes of heaven have crept into our Christian culture. I believe this accounts for much of our confusion over Genesis 1:8a. (Every Christian should study what the Bible actually says.) Earth was created with the intention that it would be heaven. The fall temporarily delayed that plan, and the Earth was cursed. Alcorn also discusses the future “new Earth.”

Those who reject this proposed understanding of *expanse* and Genesis 1:8a should carefully weigh the two choices shown in [Table 35](#).

Table 35. Two Interpretations

Interpretation	Translation	Problems
Traditional	expanse = atmosphere, outer space, heavens	Questions 1–5 Seven Scientific Issues Key Hebrew Words
Proposed	expanse of the heavens = space, etc. expanse [only] = Earth's crust	Visualizing Earth before the fall

Mythology and Canopies

Vail's case for a canopy rested largely on the mythology of the Greeks, Romans, Egyptians, and other ancient cultures. He argued that a real canopy, millions of years ago, produced these myths. Vail wrote,

I have been told again and again that the canopy idea is weak because it is founded on mythology. I can only protest that it is not founded on mythology. On the contrary mythology is largely founded on the canopy, fossilized in human thought [thought]. The canopy as a watery heaven close to the Earth existed for untold millions of years before a myth ever germinated.²⁴

We can all agree with Vail that ancient mythology and today's canopy theories are linked. But which came first: myth or canopy? If the best canopy theory cannot overcome the scientific problems mentioned earlier, then a canopy did not produce or precede the ancient myths. Myths probably produced canopy theories.

Did the flood water come from above or below Earth's surface?

If the canopy theory is correct, the flood water came from above Earth's surface. Why then did the rain fall for only 40 days after all the fountains of the great deep burst open, while

the flood waters continued to rise for 150 days, until they covered all Earth's pre-flood mountains? (Genesis 7:12–24)

However, if the flood water came from below Earth's surface, where pressures are extremely high, that subterranean water would be forced up to the Earth's surface until most subsurface water was depleted—perhaps after 150 days. If the subterranean water was initially far below Earth's surface, maybe 60 miles below, once all the fountains of the great deep burst open, that water would be ejected high above the Earth (as fountains) and fall as rain—perhaps for 40 days.

With this simple logic, confidence in the Genesis account of the flood, and an understanding of dozens of scientific problems that have perplexed scientists for decades, the hydroplate theory (explained on pages 111–433), falls into place and provides compelling insights into the history of the Earth, the Solar System, and the deadliest physical event of all time. Seeing dozens of scientific problems solved, raises confidence in the Genesis account even more.

Conclusion

Arguments for canopy theories do not stand up when examined closely, as almost all creation researchers I know now acknowledge. These theories also contain biblical and scientific problems, such as those associated with heat, pressure, sunlight, support, condensation nuclei, ultraviolet light, and the greenhouse effect. Also, canopy theories do not even begin to explain the flood's global destruction and geological activity. [Page 111 lists 25 examples.]

Canopy theories have misled many, delaying understanding of the flood, geology, and, therefore, Earth's true age. The flood water came from below, not above. Failure to understand this has caused many to doubt the historical accuracy of the flood account, and, therefore, the Bible itself. Without the flood to explain the fossils buried in the Earth's sedimentary layers, the theory of organic evolution fills the vacuum—an explanation that also removes or minimizes need for the Creator.

References and Notes

1. Isaac Newton Vail published many pamphlets on his canopy theory, starting with *Waters Above the Firmament* in 1874. Other titles included *The Misread Record* (also published under the title *The Deluge and Its Cause*), *Eden's Flaming Sword*, *Ring of Truth*, *The Heavens and Earth of Prehistoric Man*, *Canopy Skies of Ancient Man*, *A Glance at Comparative Mythology*, *Annular World Evolution*, and others. Most of these titles have been republished by Donald L. Cyr, *Waters above the Firmament* (Santa Barbara, California: Stonehenge Viewpoint, 1988). In 1902, Vail published a 400-page book titled *The Earth's Annular System*. However, it was Henry M. Morris, and John C. Whitcomb Jr. who, without acknowledging Isaac Newton Vail's contribution or even mentioning his name, popularized the canopy theory in *The Genesis Flood* (Philadelphia, Pennsylvania: Presbyterian and Reformed Publishing Co., 1961).
2. Joseph C. Dillow, *The Waters Above* (Chicago: Moody Press, 1981), p. 170.
3. Vail claimed that after the canopy collapsed, Earth was no longer shielded from the Sun's radiation, so life spans decreased. If so, people who are shielded more from the Sun's radiation should live longer—people living indoors, farther from the equator, or at lower elevations. I know of no such observation during the last 4,000 years.

4. Dillow, p. 170.
 - ◆ “It is commonly held that the pre-flood vapor canopy shielded the Earth from cosmic radiation and also reduced surface ozone levels. These effects supposedly contributed to the longevity of the antediluvian patriarchs. However, radiation studies and research in molecular biology seems to rule this out. Even if the Earth were 100 percent shielded from radiation and if ozone levels in the pre-flood world were zero, no appreciable improvement would have resulted.” Joseph C. Dillow, “The Canopy and Ancient Longevity,” *Creation Research Society Quarterly*, Vol. 15, June 1978, p. 27.
 5. Dillow, *The Waters Above*, p. 222.
 6. Doubling atmospheric pressure doubles the blood’s oxygen content. Doubling the blood’s oxygen content, by any means, can produce a disease called *retrolental fibroplasia* in unborn or premature children. An opaque membrane forms behind the lens of the eye, resulting in blindness. This also occurs in mice and other species.

Increased ambient pressure also results in excess carbon dioxide in the blood. Oxygen and nitrogen toxicities increase significantly. The problem is aggravated at high work levels and for the elderly and ill. [Personal communication with Daniel J. O’Rourke, M.D., 11 December 1994.]
 7. The Sun’s surface radiates at an effective temperature of 10,000°F, but occupies only one 10,000th of the daytime sky. A 220°F canopy, while not as hot, would radiate from the entire sky—day and night. Taking only these factors into consideration, a vapor canopy would radiate more heat than the Sun. Other complex factors might remove some of this heat.
 8. Genesis 1:14 says that the heavenly bodies were created “... for seasons, and for days and years.” Therefore, Earth’s axis was tipped relative to Earth’s orbital plane, because only by being tipped can seasonal shifts in star patterns occur.
 9. Not addressed are canopy theories that provide no scientific details or data to support speculative claims.
 10. For example, two other ways to remove this heat might be to radiate it into outer space or to conduct it into the Earth. Both processes are too slow to prevent the killing of all life on Earth.
 11. Some have proposed that a huge, icy comet struck Earth, causing a global flood and an ice age. Those proposals ignore this same heat problem. Actually, such a comet would have more kinetic energy than an ice or water canopy of equal mass. Therefore, the temperature increase would be greater.
 12. After 40 days and 40 nights, the “*geshem* rain” stopped (Genesis 7:12), because the water and its pressure under the massive crust could no longer support the fluttering edge of each hydroplate. The outward-flowing water was pinched shut, so the fountains were closed (Genesis 8:2). However, the subterranean water still trapped under the central portion of each hydroplate continued to leak out. On the 150th day, the rising flood waters covered all pre-flood mountains (Genesis 7:19–24). [See pages 111–151 and 581–582 for the scientific details supporting this explanation.]
 13. “Numerical Climate Modeling at ICR,” *Acts & Facts*, April 1998, p. 2.
 - ◆ Larry Vardiman and Karen Bousset, “Sensitivity Studies on Vapor Canopy Temperature Profiles,” *Proceedings of the Fourth International Conference on Creationism* (Pittsburgh, Pennsylvania: Creation Science Fellowship, Inc., 1998), pp. 607–618.
 14. Ancient extrabiblical writings, although not having the authority of biblical passages, also support the idea that Earth was created with water under the crust.

The First Book of Adam and Eve states in verse 70:15 that “God ... established the earth upon the waters.” *The Secrets of Enoch*, another apocryphal book, also known as *II Enoch*, says in verse 47:5, “The Lord ... fixed the earth upon the waters.” [Rutherford H. Platt Jr., editor, *The Forgotten Books of Eden* (New York: World Publishing Co., 1927), pp. 50, 98.]

II Esdras, which was part of most Christians’ Old Testaments until the Reformation, retells the same creation story found in Genesis 1. However, in *II Esdras* 6:41–42 the second and third days are described differently by Ezra.

On the second day you created the angel of the firmament, and commanded him to make a dividing barrier between the waters, one part withdrawing upwards and the other remaining below. On the third day you ordered the waters to collect in a seventh part of the earth; the other six parts you made into dry land, ... [emphasis added]
- One day after creation began, the Earth’s waters were divided into two parts, perhaps equal parts. One part was below a barrier, and the other part was above. After the third creation day but before the flood, the Earth’s seas covered only 1/7 of the Earth’s surface. Therefore, the volume of surface water was probably much less than the volume of today’s surface water, which covers 70% of the Earth. So, considerable water would have been on the other side of the barrier—much more than any canopy could have held. However, subterranean chambers could have held that amount.
- Most definitive is the word “barrier.” It hardly seems to describe the atmosphere, sky, heaven, or outer space. It aptly describes the Earth’s crust that vertically divided the Earth’s liquid water. *II Esdras* 16:58 reinforces this: “He has shut up the sea in the midst of the waters, and by His command He has hung the Earth upon the water.”
- A final, but intriguing, extrabiblical writing, *The Book of the Cave of Treasures*, is explained on page 471.
15. Stanley V. Udd, “The Canopy and Genesis 1:6–8,” *Creation Research Society Quarterly*, Vol. 12, September 1975, pp. 90–93.
 - ◆ Dillow, p. 58.
 16. Udd, p. 91.
 17. Umberto Cassuto, *A Commentary on the Book of Genesis, From Adam to Noah*, translated by Israel Abrahams (Jerusalem: The Hebrew University, 1961), p. 32.

18. M. Rosenbaum and A. Silberman, *Rashi Commentary on the Pentateuch*, Vol. 1 (Jerusalem: Silberman Family, 1930), p. 4.
19. Genesis 1:1 describes the first acts of creation on *Day 1*, and is not, as some have proposed, a topic sentence summarizing the entire creation week. The Hebrew conjunction—translated “and” joining verses 1 and 2—shows a sequential action. Similar connections—“and” and “then”—join all verses in chapter 1, tightly linking them all in time. Obviously, the creation of time (“In the beginning”) and space (“the heavens”) must precede the creation of *things*, such as Earth, waters, and light.
20. See “**Highly Compressed Solids**” on page 608.
21. A few people claim that *raqia* is the universe, and the waters above the expanse (*raqia*) surrounded the universe. This places all the heavenly bodies *in* the expanse of the heavens, and is consistent with Genesis 1:14–17. [This was first proposed by Harold L. Armstrong, “The Expanding Universe and Creation,” *Repossess the Land* (Minneapolis: Bible Science Association, 1979), pp. 22–27. More recently, D. Russell Humphreys adopted this interpretation in his book *Starlight and Time* (Colorado Springs: Master Books, 1994), pp. 34–36, 58–77.]

Surrounding the universe with water assumes that the universe is finite, when its size may be infinite, or it may

have an even more exotic geometry. Let us assume that the edge of the universe is only 10 billion light-years away, and absolutely nothing is outside it, even empty space. Surrounding the universe with as much water as the Earth contains (1.43×10^{24} grams), as just one example, would spread one gram over every 3×10^{22} square miles—or place adjacent water molecules one mile apart!

Pure water in the near vacuum of space would obviously be water vapor, not the *liquid* water the Bible describes above the expanse. What purpose would that water fulfill? It would have played no role in the flood and could not be detected today. Why then mention it in the brief first chapter of Genesis?

22. Pastor Diego Rodriguez first suggested this in a letter on 10 January 2005. Pastor Bob Enyart’s independent proposal was sent on 23 February 2005. In 2008, Pastor Rodriguez published a small book laying out a biblically sound case. [See *Paradise: Past, Present, and Future* (Fresno, California: Sound Alive Publishing, 2008).]
23. Randy Alcorn, *Heaven* (Wheaton, Illinois: Tyndale House Publishers, 2004).
24. Isaac Newton Vail, *The Misread Record* (Seattle: The Simplex Publishing Co., 1921), pp. 36, 37.

Why Don’t Creationists Publish in Leading Science Journals?

Scientists should want their conclusions critiqued, or refereed, by their peers (peer review). Researchers who believe their work is important should try to publish that work. However, leading science journals will not accept papers published elsewhere. (That stipulation alone eliminates any portion of this book from consideration.) Seldom would a science journal publish a paper more than 6 pages in length. (That also prevents the hydroplate theory, pages 109–433, from being published in a journal.)

I certainly want my ideas tested and, as explained on page 570, am willing to pay \$10,000 to anyone who can find a qualified person to do that. Also, I have frequently initiated and appreciated cordial, factual exchanges with scientists who are not creationists. But in a journal, who does the evaluation, and is there an unbiased process in which a writer who advances creation or the flood can challenge an evolutionist reviewer’s disagreement? Leading science journals have a solid history of hostility toward creationists, so evolutionists are both judge and jury. Who would want to make his case in a court run by an opponent? Why would that opponent publish your case?

To level the playing field, I have had on the table, since 1980, a written-debate offer for any qualified evolutionist or team of evolutionists who disagree with what I have written. Both sides would have the right to publish the complete debate. [See “**What Is the Written Debate Offer?**” on page 570.]

Evolutionists have known of this offer for many years. An earlier version was published in the anticeation journal, *Creation/Evolution*, in 1990. The offer was even placed on the worldwide web in 1995. So far, no evolutionist has accepted. A few initially agreed but soon dropped out, because they were unwilling to limit the exchange to science; they wanted to include (and probably ridicule) religious views. Another debate offer that, if accepted, could be heard (or read from a transcript) by the public over the Internet; it is explained on page 571. Can you find a taker for either debate? Until someone accepts the written debate and as long as my good health continues, both offers will remain.

How Did Human “Races” Develop?

In this context, there is only one race, *the human race*. Today, the word “race” has come to mean a group of people with distinguishing physical characteristics, such as skin color, shape of eyes, and type of hair. This new meaning arose with the growing acceptance of evolutionism in the late 1800s. The word “race,” when referring to physical characteristics, hardly ever occurs in the Bible.¹ Instead, the word “nation” is used more than 200 times.

The term “race” may be used to describe ethnic groups, but is not a scientific concept. Genetic and molecular variations among the so-called “races” are trivial, although a few traits may vary widely. Human variations are minor when compared with those in most other forms of life. For example, consider the many traits in the dog family. [See [Figure 3 on page 4](#).] Most varieties of domestic dogs have been produced during the past 300 years. Dogs may be white, black, red, yellow, spotted, tiny, huge, hairy, almost hairless, cute, or not-so-cute. Temperaments and abilities also vary widely. Because domestic dogs can interbreed with the wolf, coyote, dingo, and jackal, all are part of the dog kind. The vast number of genes in every kind of life permits these variations, allowing successive generations to adjust to environmental changes. Without this design feature, extinctions would be much more common. Besides, wouldn’t life be much less interesting without variations within each kind?

The following three mechanisms² probably account for most “racial” characteristics, all of which developed since the flood, approximately 5,000 years ago.

1. Natural Selection. [To understand this often misunderstood mechanism, see “**Natural Selection**” on page 6.] This well-established phenomenon does not produce macroevolution, as a century of experimentation has shown; instead, it produces some microevolution. Natural selection filters out certain parental genes in successive generations, producing offspring with slightly different characteristics *but less genetic variability*. For example, fair-skinned people living near the equator are more susceptible to several health risks, such as skin cancer. Consequently, they have slightly less chance of living to reproductive age and passing on genes for light skin color to their children. Likewise, darker-skinned people absorb less sunlight, depriving them of vitamin D₃, which forms in skin exposed to sunlight. In polar latitudes, this could cause rickets. Therefore, over many generations, dark-skinned people tend to live near the equator and light-skinned people tend to live at higher latitudes.

There are exceptions. Eskimos (Inuits) have dark skin, yet live in Arctic latitudes. However, their traditional diet, which includes fish-liver oils containing large amounts of vitamin D₃, prevents rickets.

2. Cultural Preference. This takes the form of likes (as in mate selection) or dislikes (as in prejudices).

Likes. The saying, “beauty is in the eye of the beholder,” illustrates how a person’s culture may influence mate selection along “racial” lines. This has been demonstrated in geese. Blue snow geese live in one region of the Arctic, and white snow geese live in another. In an experiment, eggs from each colony were hatched in an incubator. The goslings were then raised by “foster parents” of the opposite color. The young geese later showed a mating preference for geese having the color of their foster parents. In another experiment, the foster parents were painted pink. Again, there was a mating preference for the color the young geese saw as they were growing up, even though that color was artificial. The old song “I Want a Girl Just Like the Girl That Married Dear Old Dad” makes the point.

Dislikes. Humans also have prejudices—some people more than others. Prejudices based on physical appearances have caused wars, genocide, forced segregation, and voluntary isolation. Adolf Hitler had a fanatical hostility toward Jews and others and a strong preference for the supposedly Aryan characteristics of tall, blond, blue-eyed people.

This led to Hitler’s brutal steps to exterminate the former and increase the latter. An example of voluntary isolation occurs in Africa. Pygmies, typically 4½ feet tall, live separately from the Watusi, who are sometimes 7 feet tall. Yet, both may live within several hundred miles of each other. These and hundreds of other prejudicial actions, operating over several thousand years, segregated many people based on physical appearances.

3. Small, Isolated Populations. A population of people, or any other form of life, has many genetic characteristics. If a few members of a population move to an isolated region, such as an island, the new group will have a different and smaller set of genetic characteristics (or a smaller range of genetic potential) than the entire population. As a result, later generations on that island will have traits that differ from the original population.

Imagine a barrel filled with marbles—half-white and half-black. Let’s say that each marble represents a person, and the marble’s color represents a gene for that person’s skin color. If pairs of marbles, representing a husband and wife, are drawn at random and placed on separate islands, about half the islands will have marbles of just one color—white or black. This would be similar to the dispersion and isolation of peoples after the flood and after Babel.



Figure 250: Faces. A few members of the human race from the following places: top row, left to right: Japan, Tibet, Borneo, Holland; second row: Ireland, China, Rwanda, Korea; third row: New Zealand, Bali, Okinawa, Israel; fourth row: United States of America, Australia, India, Egypt; bottom row: Molucca Islands, Canada, Greece, Guatemala. Visualize all without variations in dress, hair style, age, and skin color. How different are we? People continents apart laugh alike and cry alike. Yes, our personalities, experiences, and talents are individually unique, but our physical differences are small; our similarities are so great they are beyond measure.

If a husband and wife had the same genes for skin color (dark or light), then their descendants would tend to have the same skin color. The color of the marbles could just as well represent other genetic characteristics.

Actually, the genetics of this process are more complicated than this simple illustration. For example, many genes determine skin color, not one. Also, there are thousands of traits, each of which might cluster in an isolated geographic region if small groups broke off from the larger population. So, specific characteristics can easily arise, as they did when the eight survivors of the flood and their descendants eventually obeyed God's command to spread out and repopulate the Earth. From the listing of Noah's descendants given in Genesis 10–11, we can see how early migration patterns began. Shem's immediate descendants stayed generally near Ararat (what is now eastern Turkey) or migrated eastward. Ham's descendants migrated southward, while Japheth's descendants migrated northward. Undoubtedly, many other small groups colonized isolated regions, allowing their unique genetic characteristics to be expressed in later generations.

Understanding these three mechanisms—natural selection, cultural preferences, and isolated populations—we can now ask some interesting questions. What did Adam and Eve look like? Obviously, their genes, modified by degenerative mutations, carried all traits humans have today—and probably other traits that have since disappeared. Many of their genes were not visible (or expressed) because other genes dominated. We usually imagine Adam and Eve as looking like ourselves. However, for genetic reasons, Adam and Eve were not “white” or “black” but something in between. The Hebrew word for Adam suggests redness, because an almost identical Hebrew word means “red” or “to show blood.” Adam's skin coloring may have been similar to that of Native Americans.

For the past 150 years, evolutionists have painted a very different picture. Man supposedly ascended from some apelike ancestor. According to the theory, because some early humans branched off sooner than others, they had different physical, mental, and behavioral characteristics. This is *racism*, a highly prejudicial school of thought that dehumanizes fellow human beings. One cannot say that evolutionists today are racists, although Charles Darwin and many of his followers were. Racism is unpopular today, at least openly, so public acknowledgment of it is rare. However, the theory of evolution provides a rationale to justify racism.³

Genesis provides quite a different historical perspective. We are all descended from Adam and Eve and from Noah and his wife. Consequently, we are all cousins. Think what the world would be like if everyone realized that and acted accordingly!

References and Notes

1. The word “race,” as applied to groups of people, is never used in the King James Version and is seldom used in modern translations. The two or three uses in these modern translations come from Hebrew and Greek words that mean “family” or “offspring,” not a variety or subspecies.
 2. A fourth mechanism may play a role. Experiments with a few plants and animals have shown that a hostile environment can switch on *preexisting* genetic machinery in a parent, so offspring are better protected. [See Item 2 on page 5.] This may partially explain skin color variations in humans.
 3. “*Biological arguments for racism may have been common before 1859* [when Darwin wrote *The Origin of Species*], *but they increased by orders of magnitude following the acceptance of evolutionary theory.*” Stephen Jay Gould, *Ontogeny and Phylogeny* (Cambridge, Massachusetts: Harvard University Press, 1977), p. 127.
- ◆ Roger Lewin, *Bones of Contention* (New York: Simon & Schuster, Inc., 1987), pp. 266–267.

Is There a Large Gap of Time between Genesis 1:1 and 1:2?

The idea that a vast period of time elapsed between the first two verses of Genesis is known as the gap theory. Most variations of this theory interpret Genesis 1:1 as the

first creation, which included the creation of the heavens, the Earth, plants and animals, and even a race of humans preceding Adam! Perhaps billions of years then elapsed,

during which time Satan and his angels fell and corrupted Earth's inhabitants. God then judged and destroyed the Earth and all its inhabitants. Thus, the Earth became "formless and void" (Genesis 1:2) and remained that way for eons. Genesis 1:3, according to the gap theory, describes the beginning of the second creation with the first day of the (re)creation week—the familiar six-day creation. This series of events is also called the "ruin-reconstruction theory," "the pre-Adamic cataclysm theory," or the "restitution interpretation."

The modern gap theory was proposed in 1814 by Thomas Chalmers, a leading Scottish theologian. Some geologists of his day argued that the Earth was much older than Genesis implied. Chalmers, therefore, proposed the gap theory to harmonize Genesis with those demands. No clear record shows anyone before 1814 interpreting Genesis 1:1–2 in this way.¹ This is especially significant, because Hebrew scholars 2,000 years ago certainly understood Hebrew writing better than we do today. The gap theory simply accommodated the growing demand for long periods of time.² Unfortunately, the adherents to the theory are usually unaware of all the scientific evidence supporting a young Earth.

What are the problems with the gap theory? Gap theorists generally believe that the fossil record was formed, not in a global flood, but when God destroyed the Earth in "the gap" between Genesis 1:1 and 1:2. Gappists have not understood how the flood rapidly formed fossils and deposited sedimentary layers with a total average thickness of one mile. For that reason, they believe that Noah's flood was less destructive than the judgment they claim preceded the creation week. No clear biblical passage supports the worldwide destruction they imagine, and they do not appreciate Noah's flood, despite references to it by many biblical writers and Christ Himself (Matthew 24:37–39, Luke 17:26–27). The gap theory resulted primarily from a failure to comprehend the flood. [See pages 111–151.]

Gap theorists also ignore this clear biblical statement that no great time gap preceded the completed creation:

For in six days the Lord made the heavens and the Earth, the sea and all that is in them ... (Exodus 20:11)

The gap theory states that the heavens were created long before the six creation days—perhaps billions of years earlier. Exodus 20:11 says the heavens (and everything else) were made in six days. If the gap theory is correct, the Sun must have shone on Earth to support the life that existed before the "gap." But Genesis 1:14–18 says the Sun was made on the fourth day of the creation week.

Gap theorists miss the importance of Christ's words in Mark 10:6, "But from the beginning of creation, God made them [Adam and Eve] male and female." Christ knew that Adam and Eve were created at the beginning, not after a vast gap of time.

According to most versions of the gap theory, the death and destruction shown by the fossil record, including the death of supposedly pre-Adamic man, *preceded* Adam's creation. But the Bible clearly states that death came *because of* Adam's sin (therefore, after Adam's creation).

If Satan fell before the creation week, as most gap theorists maintain, it is strange that at the end of the creation week, God pronounced that all He had made was "very good" (Genesis 1:31). Also, the fossil record gives evidence of death and violent burial on a global scale. How could such destruction be described as "very good" if it preceded God's pronouncement?

Why then do some believe in the gap theory? As mentioned earlier, they have accepted, perhaps unknowingly, claims that the Earth is billions of years old. Therefore, they try to find where a vast period of time might fit into the Bible. They know that long periods of time cannot be inserted after Adam's creation because the various genealogies are tightly linked.³ Consequently, the only place billions of years can be inserted is before Adam. Because time flowed smoothly and continually during the creation week, a week that for various reasons is composed of normal 24-hour days, the time gap must be inserted before the first creation day. Rather than start the creation week at Genesis 1:1 as most Bible scholars do, gappists start that week at Genesis 1:3. Therefore, they believe that before Genesis 1:3, a vast length of time existed—as they state, "whatever geologists demand."

To justify this, they propose nontraditional translations of several verses. They believe that Genesis 1:2a should be translated "the Earth *became* formless and void," instead of the more widely accepted translation "the Earth *was* formless and void." I know of no record, before 1800, of anyone advocating such a translation. While the Hebrew word "*hayah*" can be translated "became," it is usually translated "was." In the 4,900 times "*hayah*" occurs in the Old Testament, almost 98% are translated as "was." Hebrew grammarians and linguists have almost uniformly rejected the translation "became" or "had become."

Gap theorists rely heavily on Isaiah 45:18, which states:

For thus says the Lord, who created the heavens (He is the God who formed the Earth and made it, He established it and did not create it a waste place, but formed it to be inhabited),

They correctly say that God did not create the Earth a waste place. Genesis 1:2, using the same Hebrew word as in Isaiah 45:18 for "waste place," describes the Earth as "formless and void." Gap theorists unfortunately conclude that after the Earth's first creation, it must have become a waste place that was "formless and void." A more straightforward and internally consistent interpretation is that the Earth was temporarily "formless and void" during the first day of its creation. At the end of the sixth creation day, the Earth was

completed, inhabited, and “very good” (Genesis 1:31)—not “formless and void.” In other words, God “did not create it [to be] a waste place, but formed it to be inhabited.”

Another verse used to support the gap theory is Genesis 1:28, which in the King James Version states “... Be fruitful and multiply, and replenish the Earth, and subdue it ...” Today, the meaning of the English word “replenish” has shifted away from its early meaning, which was “fill.” (“Replenish” came from the French word “remplir,” which means “to fill”; it does not mean “to refill” or “to fill again.”) Almost all modern translations translate this word “fill.”

Most people who accept the gap theory have great confidence in the Bible and oppose evolution. However, they accept many evolutionary interpretations of such

things as dinosaurs, ice ages, and coal-producing peat bogs. They avoid controversy by placing dinosaurs, ice ages, and coal formation in the “gap,” and thus fail to see their connection with the flood. So, gappists generally take a position of noninvolvement in the origins issue other than saying that they accept creation and oppose evolution. This attitude helped the evolutionary viewpoint go largely unopposed in our schools and media for decades.

The gap theory has declined in popularity in recent years.⁴ It was one of many attempts to reinterpret Scripture to conform to a belief that was becoming popular among some scientists in the 1800s—a belief in an old Earth. Unfortunately, the gap theory is inconsistent with the Bible in many ways.

References and Notes

1. *“It cannot be denied, in spite of frequent interpretations of Genesis 1 that departed from the rigidly literal, that the almost universal view of the Christian world until the eighteenth century was that the Earth was only a few thousand years old.”* Davis A. Young, *Christianity and the Age of the Earth* (Grand Rapids: Zondervan Publishing House, 1982), p. 25.
 - ◆ *“... given that virtually everyone in the Western world until well into the eighteenth century still believed in a cosmos that was only a few thousand years old, almost no one was prepared to suggest that the work described in the first two verses of Genesis 1 lasted tens of thousands of years or even more prior to the work of the six days.”* Davis A. Young and Ralph F. Stearley, *The Bible, Rocks and Time* (Downers Grove, Illinois: InterVarsity Press, 2008), p. 120.
2. The best defense of the gap theory is *Without Form and Void* by Arthur C. Custance. His stated motivation for supporting the gap theory, as his widow explained to me in a letter in about 1996, was to satisfy those demanding an old Earth. Custance had written:

Furthermore, if a vast antiquity far beyond the 4000 BC traditional date is demanded [for the date of creation], there are other ways in which a great antiquity for the world prior to the creation of man can be allowed for. For example, the days of Genesis might be viewed as days on which revelation was given to Moses; or they might be taken to mean ages; or we may introduce a hiatus between Genesis 1:1 and 1:2, and so on. Arthur C. Custance, *Two Men Called Adam* (Brockville, Ontario: Doorway Publications, 1983), p. 246.
3. Some believe that names are omitted in the genealogies of Genesis. This would not alter the stated lengths of time between generations. [See [“According to the Bible, When Was Adam Created?”](#) on page 505.]
4. For the most thorough discussion and critique of the gap theory, see Weston W. Fields, *Unformed and Unfilled: The Gap Theory* (Grand Rapids: Baker Book House, 1976).

While Custance wavered on the question of the Earth’s age, he favored a young Earth.

And I do not think that the biblical account can ever be made to accommodate the antiquity that is still being demanded. Personally, I am convinced that the arguments for this vast antiquity will in due course be modified by fresh evidence and the Bible vindicated, as it always has been. Ibid., p. 249.

Is There Life in Outer Space?

There have been at least 16 major announcements that intelligent life had been found in outer space. After further study, all turned out to be false alarms. Many mistakes were humorous and showed a clear bias to “find” what reinforced unscientific beliefs.¹

However verifiable physical evidence, already explained in this book, shows that as a consequence of the flood, life

in the form of bacteria are probably on other bodies in the solar system—not advanced life, or life beyond the solar system, or “little green men.”

During the first weeks of the flood, the fountains of the great deep launched into space not only water, rocks, and dirt, but also some of the vegetation that grew abundantly on the pre-flood Earth. On that vegetation, there would have been a

variety of bacteria that could survive in the cold, oxygen-free environment of space. Those bacteria proliferated, because they carried their food source (vegetation) with them and had little competition from other forms of life, most of which died in the hostile environment of outer space.

As these bacteria consumed their vegetation, methane (CH₄) was produced. On Earth, methane almost always comes from anaerobic bacteria (bacteria that do not require oxygen).² For example, bacteria in the digestive tracks of ruminant animals (such as cattle, buffalo, sheep, goats, and camels) produce at least 20% of the methane in Earth's atmosphere. Bacteria in other animals and humans produce much less methane. On rare occasions, small amounts of methane can be produced by a reaction between the mineral olivine and liquid water, but, of course, *liquid* water rarely exists in outer space. Therefore, bacteria probably produced the methane that has been detected (or believed to be present) on all planets in the solar system, on some comets, asteroids and trans-Neptunian objects, and on most of the larger moons. Living, but dormant, bacteria have even been discovered in meteorites. [See "[Meteorites Return Home](#)" on page 351.]

Titan. One example is Titan, Saturn's largest moon, which has large amounts of methane. Because Titan's average temperature is an extremely cold -179°C, and methane (normally a gas on Earth) liquefies at -161°C, Titan "is etched with canyons that are flooded with liquid" methane.³

[Titan] remains an enigma, explored only by remote sensing from Earth, and by the Voyager and Cassini spacecraft. The most puzzling aspects include the origin of the molecular nitrogen and methane in its atmosphere, and the mechanism(s) by which methane is maintained in the face of rapid destruction by photolysis.⁴

It should not be surprising that some methane remains on Titan despite the "rapid destruction" of methane by the Sun's radiation, because the flood occurred recently. [See "[When Was the Flood, the Exodus, and Creation?](#)" on page 482.] Nor is it surprising to find the most abundant gas in Earth's atmosphere (molecular nitrogen, N₂) on Titan, because the fountains of the great deep would have entrained and also launched some N₂.

Mars. For similar reasons, Mars probably contains bacteria. Three independent groups of scientists have discovered methane (CH₄) in Mars' atmosphere. The quantities are small but significant, averaging about 10 parts per billion by volume. Sunlight slowly destroys methane, so something, must be replenishing that methane.⁵ (Volcanoes on Mars are dormant, and comets and asteroids are not hitting Mars fast enough *today* to replenish its methane, although they would have in the centuries after the flood. Also, methane in Mars' atmosphere should mix uniformly in only a few months, but methane's concentration varies around the planet and appears to be concentrated where water once flowed.⁶



PREDICTION 57: Bacteria will be found on Mars. Their DNA will be similar to Earth's bacteria. Furthermore, isotopes of the carbon in Mars' methane will show the methane's origin is biological.

Earth. Most methane on Earth is trapped in molecule-size, crystalline cages formed by frozen water called *hydrates*. Each cage holds at least one methane molecule. Methane hydrates, first discovered in 1970, lie on the cold ocean floor off the coasts of all continents. [See "[Methane Hydrates](#)" on page 116 and the picture of "flaming ice."] Methane hydrates contain more fossil fuel than is in all Earth's coal and oil deposits combined. Why is so much methane there?

As the hydroplates suddenly crushed and thickened during the compression event at the end of the flood, draining flood waters swept vegetation off the edge of continents. Bacteria, which are extremely small and plentiful,⁷ were on each leaf fragment, blade of grass, and log, as they are today. If bacteria have food, they can survive and multiply exponentially even in the cold, wet sediments on the ocean floors. Preflood vegetation deposited around all continents was that food, so its carbon became the main part of methane, a by-product of decay. At the temperatures and pressures on the ocean floor, most methane becomes methane hydrates.

Those who believe that advanced life exists on distant planets base their belief on the following reasoning:

Life evolved on Earth. Because the universe is so immense and contains so many heavenly bodies, life must have evolved on other planets as well.

This flawed reasoning assumes that life evolved on Earth, but overwhelming evidence shows that life is so complex it could not have evolved—anywhere! [See pages 5–25.] Over the last 150 years, our culture has been so saturated with evolution theory that some uncritically believe life evolved, so they excitedly conclude that life must also have evolved on at least a few of the multitude of other planets.

Yes, there are billions of planets. [See "[Have Planets Been Discovered Outside the Solar System](#)" on page 513.] However, the probability of just one living cell forming by natural processes is so infinitesimal, *even considering the vast number of planets*, that the likelihood of life evolving from dead matter anywhere in the universe is virtually zero!

Despite popular and influential science fiction books and films, such as *Star Wars*, *E.T.*, *Star Trek*, and *Close Encounters of the Third Kind*, there really is no scientific evidence for intelligent extraterrestrial life, even though hundreds of millions of tax dollars have been spent trying to find life in outer space. Conditions outside Earth are more destructive than almost anyone suspected before space exploration began: deadly radiation, extreme gravitational forces, poisonous gases, gigantic explosions, and the absence of the

proper atmospheres and chemical elements. Unfortunately, these physical realities do not excite public imagination as much as science fiction and evolutionary stories.

A few researchers are searching for radio signals from outer space that would imply an intelligent source. Radio telescopes, linked with computers, simultaneously search millions of radio frequencies for a nonrandom, nonnatural, extraterrestrial signal—any short sequence of information. But the long sequence of information in the DNA of every living thing on Earth is a sign of a vast intelligence—a Creator with unfathomable intelligence. Those searching for extraterrestrial life believe life evolved naturally in outer space. If they ever accepted just the DNA evidence for a Creator, the evolutionary basis for their search would disappear. [See “Codes, Programs, and Information” on [page 9](#).]

If life evolved in outer space as easily as some believe, many extraterrestrial “civilizations” should exist, especially on planets around stars that evolutionists claim are older than our Sun. Wouldn’t some civilizations that were technologically superior to ours have tried to reach us when they realized that Earth has abundant life? Any superior civilization within our galaxy would probably have already explored our solar system, at least with robots. As the famous physicist Enrico Fermi once said when asked if he thought life existed beyond Earth, “*Where is everybody?*” Because we have no verifiable evidence of any of this, intelligent extraterrestrial life probably does not exist, certainly within our Milky Way Galaxy.

Almost all stories of unidentified flying objects (UFOs) have since been traced to natural or manmade causes. Even if technically advanced flying objects exist, they may have a terrestrial, not extraterrestrial, origin. The United States, for example, developed and flew the superfast

SR-71 aircraft and its prototype several years before most senior military officers in the United States knew such technology was possible. Evidence that UFOs are from extraterrestrial civilizations, although not disproved, has not been verified and usually relies on the truthfulness, rationality, and accuracy of a few alleged witnesses.

Could God have created life elsewhere? Certainly, but the Bible is largely silent on this subject. However, the Bible does say, “*For in six days the Lord made the heavens and the Earth, the sea, and all that is in them.*” (Exodus 20:11a) So, if life were created in outer space, it would have happened during the six creation days.

Three other Bible verses suggest that conscious, rational life is unique to Earth.

1. Romans 8:22 states, “*the whole creation groans and suffers*” because of Adam’s sin. This would be a strange statement if humanlike beings existed in outer space, because it would mean that those not descended from Adam suffer because of his sin.
2. Romans 5:12 tells us, “*through one man [Adam] sin entered the world.*” The Greek word we translate as “world” is *kosmos*, which generally means the entire universe. Again, if intelligent beings exist beyond Earth, they would be suffering for Adam’s sin.
3. Genesis 1:14 states that the heavenly bodies were made “*for signs, and for seasons, and for days and years.*” It does not say that they were created as habitats for other creatures.

Is there *advanced* life in outer space? Probably not. Many people enjoy speculating on this subject, and some want to believe that life is in outer space, usually life that is superior to ours. Little rational basis exists for this belief—either scientific or biblical.

References and Notes

1. John Wenz, “16 Times We Didn’t Find ET,” *Discover*, Vol. 39, October 2018, pp. 64-65
2. If considerable oxygen and anaerobic bacteria are present, water and carbon dioxide will be produced, instead of methane.
3. Valerio Poggiali, “Methane-Filled Canyons on Titan,” *Nature*, Vol. 536, 18 August 2016, p. 253.
4. H. B. Niemann, et al., “The Abundances of Constituents of Titan’s Atmosphere from the GCMS Instrument on the Huygens Probe,” *Nature*, Vol. 438, 8 December 2005, p. 779.
5. Vittorio Formisano et al., “Detection of Methane in the Atmosphere of Mars,” *Science*, Vol. 306, 3 December 2004, pp. 1758–1761.
- ◆ Sushil K. Atreya, “The Mystery of Methane on Mars and Titan,” *Scientific American*, Vol. 296, May 2007, pp. 42–51.
- ◆ See Endnotes [37–u](#) on [page 329](#).
6. “*A little over 100 metric tons of methane would have to be produced [on Mars] each year to maintain a constant global average of 10 ppbv [parts per billion by volume].*” Atreya, p. 46.
 - ◆ About 45% of organic matter and 75% of methane is carbon by weight. Anaerobic bacteria convert about 76% of the available carbon to methane. Assume that eleven comets (or asteroids), weighing 10^{16} grams each, struck Mars and only one hundred thousandth of each impactor consisted of organic matter. That would allow 100 metric tons of methane to slowly escape into Mars’ atmosphere for each of 5,000 years. (1 metric ton = 10^6 grams.)

$$\frac{11 \times 10^{16} \times 0.45 \times 0.76}{100,000 \times 5,000 \times 10^6 \times 0.75} = 100 \text{ metric tons of methane per year}$$
 Other reasonable combinations of numbers produce similar results, so more carbon should still be trapped in Mars’ soil.
7. Microbial cells, such as bacteria, are extremely small. Our bodies contain 10 times more microbes cells than human cells.

Have Scientific Tools Detected Adam and Eve within Us?

Cells of every plant, animal, and human contain tiny strands of coded information called *DNA*.¹ DNA directs the cell, telling it what to produce, when to produce it, and where it is to go. Therefore, much of your appearance and personality is determined by the DNA you inherited from your parents.

In human cells, the nucleus contains 99.5% of the DNA. Half of it came from the individual's mother and half from the father. Because both halves are shuffled together, it is difficult to identify which parent contributed any tiny segment, so half of this DNA changes with each generation. However, outside the nucleus of each cell are thousands of little energy-producing components called *mitochondria*, each containing a circular strand of DNA. Mitochondrial DNA (mtDNA) comes only from the mother. Where did she get hers? From her mother—and so on. Unless there is a rare mutation, mtDNA does not change from generation to generation.

DNA is written with an alphabet of four letters: A, G, T, and C. One copy of a person's mtDNA is 16,559 letters long. Sometimes a mutation changes one of the mtDNA letters that a mother passes on to her child. These rare and somewhat random changes allow geneticists to identify families. For example, if your grandmother experienced an early mutation in her mtDNA, her children and any daughters' children would carry the same changed mtDNA. It would differ, in general, from that in the rest of the world's population.²

In 1987, a team at the University of California at Berkeley published a ground-breaking study comparing the mtDNA of 147 people from five of the world's geographic locations.³ The study concluded that all 147 had the same female ancestor. She is now called "*Mitochondrial Eve*."

Where did Mitochondrial Eve live? Initial research concluded she probably lived in Africa. Later, after much debate, researchers realized that Asia and Europe were also possible origins for Mitochondrial Eve.⁴

From a biblical perspective, do we know where Eve lived? Because the flood was so destructive, no one knows where the Garden of Eden was.⁵ However, Noah's three daughters-in-law, who lived only a dozen or so generations after Eve, probably began raising their families near Mount Ararat in eastern Turkey—very near the common boundary of Asia, Africa, and Europe. (Each of us can claim one of Noah's daughters-in-law as our ever-so-great grandmother.) So, it is not surprising that Asia, Africa, and Europe are candidate homes for Mitochondrial Eve.

Also, when similar words, sounds, and grammar of the world's most widely spoken languages are traced back in time, they also seem to originate near Ararat.⁶ Another convergence near eastern Turkey is found when one traces agriculture back in time.⁷



Figure 251: Language Divergence. Languages are related, as are genes. One of thousands of examples is the word for “from, of.” It exists in French (*de*), Italian (*di*), Spanish (*de*), Portuguese (*de*), and Romanian (*de*). So, these languages, now spoken generally in southwestern Europe, are twigs on a tree branch called the *Romance languages*. (Romance refers to Rome.) This branch joins a larger branch that includes all languages derived primarily from Latin. They merge with other large branches (such as the Germanic branch that includes English) into a family called the *Indo-European languages*. When these and other languages are traced back in time, they appear to converge near Mount Ararat, a likely landing site of Noah's Ark.⁸ [See pages 45–48.] Linguists admit that they do not understand *the origin* of languages, only how languages spread.⁹

When did Mitochondrial Eve live? To answer this, one must know how frequently mutations occur in mtDNA. Initial estimates were based on the following *faulty* reasoning: “Humans diverged from chimpanzees about 6-million years ago. Because the mtDNA in humans and chimpanzees differ in 1,000 places, one mutation occurs about every 12,000 years.” Another incorrect approach began by assuming Australia was first populated 40,000 years ago. The average number of mitochondrial mutations among Australian aborigines divided by 40,000 years gave another extremely slow mutation rate for mtDNA. These estimated rates, based on evolution, led to the mistaken belief that Mitochondrial Eve lived 100,000–200,000 years ago.¹⁰ This surprised evolutionists who believe that the first human female lived 6-million years ago.

A greater surprise, even disbelief, occurred in 1997, when it was announced that mutations in mtDNA occur 20 times faster than had been estimated. Without assuming humans and chimpanzees had a common ancestor 6-million years ago or that Australia was populated 40,000 years ago, mutation rates can now be determined directly by comparing the mtDNA of many mother-child pairs. Using the new, more accurate rate, *Mitochondrial Eve lived only about 6,500 years ago*.¹¹

Is there a “genetic Adam”? At conception, each man received from his father a segment of DNA which lies on the Y chromosome; this makes him a male. Where did your father receive his segment? From his father. If we all

descended from one man, all males should have the same Y chromosome segment—except for rare mutations.

A 1995 study of a worldwide sample of 38 men showed no changes in this segment of the Y chromosome that is always inherited from fathers. Had humans evolved and all men descended from one male who lived 500,000 years ago, each should carry about 19 mutations. Had he lived 150,000 years ago, 5.5 mutations would be expected.¹² Because no changes were found, our common father probably lived only thousands of years ago. While Adam was father of all, our most recent common male ancestor was Noah.

In 2010, a comprehensive comparison was made between the DNA on the male Y chromosome of humans and chimpanzees. The differences were more than 30 percent!¹³

For completeness, we must consider another possibility. Even if we all descended from the same female, other women may have been living at the same time. Their chains of continuous female descendants may have ended; their mtDNA died out. This happens with family names. If Mary and John XYZ have no sons, their unusual last name dies out. Also, many other men may have lived at the same time as our “genetic

Adam,” but had no continuous chain of male descendants down to today. How likely is it that other men lived a few thousand years ago but left no continuous male descendants, *and* other women lived 6,000 years ago but left no continuous female descendants, *and* we end up today with a world population of 7 billion people? Extremely remote!¹⁴

Yes, new discoveries show that we carry traces of Adam and Eve in our cells. Furthermore, our common “parents” are probably removed from us by only 200–300 generations. All humans have a common and recent bond—a family bond. We are all cousins.

Furthermore, the mitochondrial DNA in all life (animals and plants), carries a unique signature, called the DNA barcode, that uniquely identifies 5.5 million species, including humans. Each species only produces others of the same species, and the gaps between species are huge. [See “**Distinct Types**” on page 7.] Members of each species, including humans, can all trace their ancestry back to a common male and female of the same species, all of whom began giving birth at about the same time.¹⁵

References and Notes

1. Red blood cells in humans (and mammals) are an exception. After a red blood cell matures, it loses its nucleus (and, of course, the DNA in its nucleus).
 2. This simplified explanation is complicated by *heteroplasmy*, a form of inheritance for mtDNA. Heteroplasmy introduces slight statistical uncertainty in normal inheritance patterns.
 3. Rebecca L. Cann et al., “Mitochondrial DNA and Human Evolution,” *Nature*, Vol. 325, 1 January 1987, pp. 31–36.
 4. Marcia Barinaga, “‘African Eve’ Backers Beat a Retreat,” *Science*, Vol. 255, 7 February 1992, pp. 686–687.
 - ◆ Alan R. Templeton et al., “Human Origins and Analysis of Mitochondrial DNA Sequences,” *Science*, Vol. 255, 7 February 1992, pp. 737–739.
 - ◆ “African Eve Gets Lost in the ‘Trees,’” *Science News*, Vol. 141, 22 February 1992, p. 123.
 5. Some believe that the Garden of Eden was near today’s Tigris and Euphrates Rivers, because Genesis 2:14 says rivers having those names flowed out of Eden. However, the flood’s destructiveness probably buried the Garden of Eden and pre-flood rivers under thousands of feet of sediment. (Indeed, today’s Tigris and Euphrates Rivers flow over thick sedimentary layers deposited during the flood. Those layers contain some of the world’s richest oil fields.) Continental movement and changes in continent thicknesses and topography would also have altered Eden’s location and the flow of rivers. [For details, see pages 111–151.]
- It seems more likely that the survivors of the flood gave the two powerful rivers near Mount Ararat (today’s Tigris and Euphrates Rivers) the same names as rivers those survivors knew before the flood. (Settlers in a new land often name geographical features after familiar landmarks in their “old world.” Noah and his descendants probably did not know where they were, so they may have attached pre-flood names to post-flood geography.) This would also explain why the other rivers mentioned in Genesis 2 are not known today and why the pre-flood rivers described in Genesis 2:10–14 had the following characteristics that differ from today’s rivers:
- ◆ The river flowing out of Eden divided into four rivers. Today, rivers rarely divide; they merge.
 - ◆ Two of the Genesis rivers (Pishon and Gihon) flowed *around* a land, something that doesn’t happen today.
- To understand why pre-flood rivers had these strange characteristics and the source of each river’s water, see pages 475–479.
6. “*Our work indicates that the protolanguage originated more than 6,000 years ago in eastern Anatolia* [eastern Turkey] ...” Thomas V. Gamkrelidze and V. V. Ivanov, “The Early History of Indo-European Languages,” *Scientific American*, Vol. 262, March 1990, p. 110.
 - ◆ Remco Bouckaert et al., “Mapping the Origins and Expansion of the Indo-European Language Family,” *Science*, Vol. 337, 24 August 2012, pp. 957–960.
 7. Colin Renfrew, “The Origins of Indo-European Languages,” *Scientific American*, Vol. 261, October 1989, p. 114.
 - ◆ “*The wild ancestors of the seven ‘founder crops’ harvested by the world’s first farmers have all been traced to the region of south-*

eastern Turkey and northern Syria.” Michael Balter, “Search for the Indo-Europeans,” *Science*, Vol. 303, 27 February 2004, p. 1324. [See also Simcha Lev-Yadun et al., “The Cradle of Agriculture,” *Science*, Vol. 288, 2 June 2000, pp. 1602–1603.]

8. Ewen Callaway, “Language Origin Debate Rekindled,” *Nature*, Vol. 518, 19 February 2015, p. 284.

Both theories being debated place the beginning of Indo-European languages very near Mount Ararat, one just north of the Black Sea, and the other just south of the Black Sea.

9. Several generations after the flood, languages multiplied at Babel (Genesis 11:1–9). The name Babel gives us our word “to babble,” meaning “to utter meaningless sound s.” Most scholars place Babel’s location somewhere between today’s Tigris and Euphrates Rivers, near the site of ancient Babylon and Mount Ararat.
10. This widespread (and, I believe, incorrect) belief that Mitochondrial Eve lived 100,000–200,000 years ago should be contrasted with a completely different but highly mathematical analysis. [See Douglas L. T. Rohde et al., “Modelling the Recent Common Ancestry of All Living Humans,” *Nature*, Vol. 431, 30 September 2004, pp. 562–566.]

These authors believe that our most recent common male and female ancestor lived only a few thousand years ago, but the authors recognize that the many assumptions in their model—especially migration rates and realistic mating patterns—could alter that number by a few thousand years.

Therefore, it seems very unlikely that the Mitochondrial Eve could have lived 100,000–200,000 years ago. A similar conclusion can be reached for the genetic Adam.

11. *“Regardless of the cause, evolutionists are most concerned about the effect of a faster mutation rate. For example, researchers have calculated [previously] that ‘Mitochondrial Eve’—the woman whose mtDNA was ancestral to that in all living people—lived 100,000 to 200,000 years ago in Africa. Using the new clock, she would be a mere 6000 years old.”* Ann Gibbons, “Calibrating the Mitochondrial Clock,” *Science*, Vol. 279, 2 January 1998, p. 29.
 - ◆ *“If molecular evolution is really neutral at these sites [occurs at a constant rate at all sites], such a high mutation rate would indicate that Eve lived about 6500 years ago—a figure clearly incompatible with current theories on human origins.”* Laurence Loewe and Siegfried Scherer, “Mitochondrial Eve: The Plot Thickens,” *Trends in Ecology & Evolution*, Vol. 12, 11 November 1997, p. 422.
 - ◆ *“Thus, our observation of the substitution rate, 2.5/site/Myr [million years], is roughly 20-fold higher than would be predicted from phylogenetic analyses [evolution studies]. Using our empirical rate to calibrate the mtDNA molecular*

clock would result in an average age of the mtDNA MRCA [most recent common ancestor] of only ~6,500 y.a. [years ago], clearly incompatible with the known age of modern humans.” Thomas J. Parsons et al., “A High Observed Substitution Rate in the Human Mitochondrial DNA Control Region,” *Nature Genetics*, Vol. 15 April 1997, p. 365.

Evolutionists who understand this new discovery are shocked. They are now trying to explain why measured mutation rates of mtDNA are so fast, while their inferred mutation rates (based on fossil dating and the evolution of man from apelike creatures) are so slow. Perhaps, they say, mutations occur rapidly at only a few points on the mtDNA molecule, but later correct themselves. Therefore, many mutations are counted, but the net change is small. This “hot spot” hypothesis, is basically a “special pleading”—something imagined to solve a problem. Tests have shown the “hot spot” hypothesis to be invalid.

Thus, the “hot spot” hypothesis, in the absence of additional elements, does not seem a sufficient explanation for the high observed substitution rate.

Parsons et al., p. 365.

12. Robert L. Dorit et al., “Absence of Polymorphism at the ZFY Locus on the Human Y Chromosome,” *Science*, Vol. 268, 26 May 1995, pp. 1183–1185.
 - ◆ A similar study found that this same DNA segment differed considerably in three types of apes: a chimpanzee, two orangutans, and three gorillas. For the three gorillas it was identical, as it was for the two orangutans. [See Wes Burrows and Oliver A. Ryder, “Y-Chromosome Variation in Great Apes,” *Nature*, Vol. 385, 9 January 1997, pp. 125–126.]
- Statisticians recognize that when variations exist between groups but not within groups, it implies that the groups are distinct, unrelated populations. In other words, gorillas, orangutans, and chimpanzees probably did not evolve from some common ancestor. Of course, this DNA segment in humans was unrelated to an even greater degree.
13. *“More than 30% of the DNA differs between the two species.”* Constance Holden, “Surprise in the Y,” *Science*, Vol. 327, 22 January 2010, p. 397.
 14. Today, the world’s population is 7 billion people. Even if many women lived 6,000 years ago, *on average, each female must have had many children.* Whenever the average number of children per female exceeds two, the chance of *only one* of these many females having continuous female descendants today becomes highly improbable. A similar unlikely event must also happen for males. Having both improbable events happen concurrently is ridiculously improbable.
 15. Mark Stoeckle and David Thaler, “Why Should Mitochondria Define Species?” *Human Evolution*, Vol. 33, pp. 1–29.

Is Evolution Compatible with the Bible?

Many people, although they may not know the term, are **theistic evolutionists**; that is, they believe *God used evolution to create the universe and everything in it*. For some, this is an acceptable compromise—belief in at least some aspects of evolution and belief in God. The first provides scientific respectability, while the second satisfies an inward conviction that there must be a Creator (Romans 11:20). For these people, evolution is compatible with the Bible.

But is it? Since Darwin's time (mid-late 1800s), many who knew what the Bible says have tried to reinterpret Scripture to make it compatible with the theory of evolution. The fact that there are about twenty theistic evolution theories indicates the general dissatisfaction with each. It also suggests that reconciling evolution with the Bible is not as easy as some claim. You will soon see why.

Better-known efforts to reinterpret the early chapters of Genesis include the day-age theory,¹ the gap theory (pages 529–531), the framework theory,² the revelation theory,³ and progressive creation.⁴ Each theory uncritically accepts some aspects of evolution and then reinterprets Genesis to force it to accommodate those aspects. These reinterpretations contradict obvious meanings in Scripture, interpretations of the text made by ancient and modern Hebrew scholars, clear statements of many Old Testament writers, all New Testament writers, and Jesus Christ Himself.

Hebrew Professor James Barr at the University of Oxford wrote:

... probably, so far as I know, there is no professor of Hebrew or Old Testament at any world-class university who does not believe that the writer(s) of Gen. 1–11 intended to convey to their readers the ideas that (a) creation took place in a series of six days which were the same as the days of 24 hours we now experience (b) the figures contained in the Genesis genealogies provided by simple addition a chronology from the beginning of the world up to later stages in the biblical story (c) Noah's flood was understood to be

*world-wide and extinguished all human and animal life except for those in the ark. Or, to put it negatively, the apologetic arguments which suppose the "days" of creation to be long eras of time, the figures of years not to be chronological, and the flood to be a merely local Mesopotamian flood, are not taken seriously by any such professors, as far as I know. The only thing I would say to qualify this is that most such professors may avoid much involvement in that sort of argument and so may not say much explicitly about it one way or the other.*⁵

Some theistic evolutionists sincerely reject certain tenants of evolution, but may not realize that they have accepted key evolutionary assumptions on which these theories are based. Those assumptions may appear "scientific," unless the evidence is closely examined. The most common of these assumptions is that Noah's flood was only local and the Earth is billions of years old. The two beliefs are related, because not comprehending the flood, explained on pages 109–433, usually leads to a belief in a 4.5 billion-year-old Earth. Understanding the flood will reveal a young Earth and the origin of Earth's radioactivity. [See pages 379–433.]

No single theistic evolutionary theory incorporates all 74 beliefs listed below.⁶ However, each perspective is compatible with one or more of the primary theistic evolution theories. Almost no compelling scientific evidence supports any of these evolutionary positions, and much evidence refutes them. [See "**The Scientific Case for Creation**," pages 5–107.]

Notice how many ideas in the left-hand column below are uncritically accepted by mainstream society—even many theologians. Notice also how these ideas have subtly alienated many from the Bible—which both contradicts theistic evolution and lays the foundation for some of our most basic beliefs and institutions. Undermining this foundation has obviously contributed to many societal problems. [See "**What Are the Social Consequences of Belief in Evolution?**" on page 551.]

Table 36. Theistic Evolution vs. The Biblical Account

Theistic Evolution	The Biblical Account
1. Creation required few, if any, miracles. Science can now explain how everything evolved.	Creation was a miracle. Evolution, if true, would require many miracles. [See pages 5–107.] A miracle is a departure from physical laws.
2. Genesis 1–11 is either allegory, poetry, or myth. It is not literally true.	Genesis 1–11 is accurate history involving real people and major events. Jesus Christ and every New Testament writer cited these foundational events that shaped human culture. [See the 68 references beginning on page 553.]
3. Genesis contains two conflicting creation accounts, Genesis 1:1–2:3 and Genesis 2:4–2:25. Obviously, both cannot be correct—or taken literally.	Genesis contains two descriptions of creation. The first is chronological, while the second is from man's perspective. A close study of the Hebrew words shows no conflict. Christ, who in a single sentence mentioned both descriptions, knew they referred to the same creation event. (Mt 19:4–5) [Endnote 1 on page 479 contains additional information.]

Theistic Evolution	The Biblical Account
4. Natural processes (or “Mother Nature”) can explain the formation of the heavenly bodies, Earth, and life. Matter preceded mind.	The Creator, with purpose and supernatural power, brought forth the heavenly bodies, Earth, and life. Mind preceded matter. (Gen 1–2, Ps 19:1, Ps 33:6)
5. Space, time, and matter are eternal. Time existed before things were created.	God who is eternal, created space, time, and matter. The creation came out of nothing. There was a beginning. ⁷ Time began at the creation. (Gen 1:1, Mt 24:21, Mk 13:19, Jn 1:1, Col 1:16, Heb 11:3)
6. The universe began with a big bang and blinding light. Then the universe expanded trillions of billions of times faster than the speed of light. Ten-billion years later, the Earth slowly formed in the presence of sunlight.	On Day 1, the Earth was formed in darkness. (Gen 1:2) Soon afterward, but before the Sun and stars were made, blinding light appeared. (Gen 1:3) To appreciate how exceptionally bright the light was, see page 442. [See also “If the Sun and Stars Were Made on Day 4, What Was the Light of Day 1?” on pages 460–461.]
7. The big bang was the basic creation event. It occurred during a fraction of a second.	A series of creative acts occurred during the creation week. (Gen 1) God stretched out the heavens. [See “Why Is the Universe Expanding?” on pages 439–454.]
8. Hydrogen, helium, and some lithium formed millions of years before all the other 100 ⁺ chemical elements.	Almost all chemical elements came into existence during the creation week. (Gen 2:2, Ex 20:11)
9. Since the big bang, the average temperature of the universe has continually decreased. Eventually, the Sun will exhaust its fuel and the Earth will lose its heat and freeze solid.	The Earth began in a relatively cool state (see #12 below). Eventually, intense heat will destroy the heavens and the Earth. (II Peter 3:7,10,12)
10. The Sun and most stars formed billions of years before Earth. Stars are still forming.	Earth was created three days before the Sun and stars. Today, stars are dying, not being created. (Gen 1:2, 1:16; Ex 20:11) [See page 35.]
11. During the fourth creation period (not the fourth day), the Sun, Moon, and stars were “made to appear” ⁸ on a previously cloud-covered Earth.	On the fourth creation day, the Sun, Moon, and stars were made. (Gen 1:14–19) If the word “day” in Genesis 1:14 means a long period, what do the words “year” or “night” mean in those verses?
12. The Earth initially had a hot, molten surface. Millions of years later, water oozed out of Earth’s interior.	On the first day, the Earth had a liquid water surface. ⁹ Therefore, the Earth was relatively cool at the beginning. (Gen 1:2)
13. The Earth slowly coalesced from meteoritic impacts that melted the Earth’s surface and vaporized all surface water.	The Earth formed quickly. After the second day, its solid surface—Earth’s crust—was spread out above the liquid subterranean waters. (Ps 24:2, 104:3, 136:6)
14. Land formed before oceans.	A global ocean existed before the surface waters were gathered into one place and dry land first appeared. (Gen 1:2, 1:9)
15. Evolution occurred over billions of years, not in six literal days. The word “day” in the Bible can, in rare cases, mean an indefinite period of time. The six creation “days” may have been six ages, so each creation age had millions of evenings and mornings. Another possibility is that God created in six literal days, but each day was separated by millions of years.	Creation occurred in six literal, consecutive days. (Gen 1, Ex 20:11) The Hebrew word for day, <i>yom</i> , always means literal, consecutive days when modified by a plural number. <i>Yom</i> was defined as a literal day when it was first used. (Gen 1:4,5) Each creation day had only one “evening and morning”
16. In the Bible, a day can be a long time. For example, Psalm 90:4 and II Peter 3:8 say that “a day is like a thousand years.”	To survive, plants need the Sun and animals—especially insects. All were created within three literal days of each other. (Gen 1:11–23) Had it taken much longer, plants could not have survived. ¹⁰ (Gen 1:5, 8, 13, 19, 23, 31)
17. Since the Earth began, natural disasters have occurred: earthquakes, floods, hurricanes, tornadoes, lightning strikes, volcanic eruptions, tsunamis, droughts, blizzards, and impacts by meteorites, asteroids, and comets.	Those verses do not refer specifically to the six creation days. Instead, they say that God is outside of time; He sees the intimate details and the big picture. Besides, no evolutionist believes creation took 6,000 years.
18. The present is the key to the past; that is, presently observable natural processes explain all past events. (This principle, called <i>uniformitarianism</i> , underlies much of geology.)	These calamities were not part of God’s “ <i>very good</i> ” creation. Later, man’s sin destroyed that tranquility. Man’s wickedness became so bad that God chose to destroy almost all men and air breathing land animals in a global flood. (Gen 1:31, 6:5–7) Part II of this book explains why most natural disasters, including radiation damage, are a consequence of the global flood. [See pages 109–433.]
19. There have been no worldwide floods—only brief, local floods. “Noah’s flood,” if it happened, was only a local, or regional, flood. God’s promise, in Genesis 9:11, not to again flood the Earth cannot be taken literally.	The present is not always the key to the past. God sometimes works suddenly, as He did during the creation, the fall, and the flood. (Gen 1–3, 6–8) No natural process on Earth approaches the flood in its power, destructiveness, or extent. (II Peter 3:3–6) [See pages 109–433.]
20. The first sea life was a small blob of complex chemicals. It took a billion years for other sea life to form.	A catastrophic, worldwide flood covered <i>all</i> ¹¹ the Earth’s pre-flood mountains after 150 days. (Gen 7:19–20, 7:24; Ps 104:6–9) This year-long flood (Gen 7:11, 8:14) destroyed almost all humans and air-breathing land animals. (Gen 6:13, 6:17, 7:4, 7:21–23, 8:21, 9:11; Lk 17:27; I Pet 3:20; II Pet 2:5, 3:6)
20. The first sea life was a small blob of complex chemicals. It took a billion years for other sea life to form.	On the fifth day, sea life was created, and the waters swarmed with all the various kinds of sea creatures. (Gen 1:20–22)

Theistic Evolution	The Biblical Account
21. The original atmosphere consisted of methane, ammonia, and other poisonous gases. Over billions of years, the atmosphere evolved into what it is today.	The atmosphere was created quickly and has since supported all living things. (Gen 1:6–8)
22. Rain began as the Earth's atmosphere evolved.	Rain did not occur before the flood. [See pages 475–479.]
23. Plant life helped our atmosphere evolve.	The atmosphere was created before plant life. (Gen 1:6–12)
24. Plants evolved over a long period of time. Flowering plants evolved 220-million years after all other plants.	All major categories of plants, including their seeds and fruit, were created on the third day. (Gen 1:11–12)
25. The Sun evolved several billion years before plant life.	The Sun was made one day after plant life. (Gen 1:12–16)
26. Various forms of plant and animal life evolved during each of four sequential, geological eras: Precambrian, Paleozoic, Mesozoic, and Cenozoic. These eras were of unequal length.	Life was created during only three of the six creation days—3rd day: plant life, 5th day: sea life and birds, and the 6th day: other land animals and man. (Gen 1)
27. Since the Earth began, new forms of life have continued to evolve within each of the major categories: plants, sea creatures, birds, and land animals.	All plants were created first, then all sea creatures and birds, then all land animals. Finally, man was created—Adam first, then Eve. (Gen 1, 2:21–22)
28. There is continuity among all forms of life. All organisms have a common ancestor. Therefore, there were continuous transitions among all plants and among all animals. The millions of species are not fixed and not distinct.	There are permanent discontinuities between the many different “kinds” of life. In fact, the Bible states <i>10 times</i> that each “kind” will reproduce after itself. (Gen 1) The kinds are fixed and distinct. (I Cor 15:39)
29. Sea life preceded land life by hundreds of millions of years.	Sea life was created two days after the first land life. (Gen 1:11–13, 1:20–23)
30. Adam could not have named all the animals in one day, because there were too many. Besides, most animals and plants became extinct before man evolved.	The Bible does not say that Adam named all the animals. On <i>Day 6</i> , he named “all the cattle,” “the birds of the sky,” and “every beast of the field” (domesticated animals). Adam did not name, for example, sea creatures, creeping things (insects), and the beasts of the Earth (wild animals). (Gen 2:20) All animal kinds have lived contemporaneously with man—even dinosaurs. (Gen 1:20–30)
31. Insects evolved millions of years before birds and flowering plants. We don't know the origin of insects.	All birds and plants were created before “ <i>creeping things</i> .” (Gen 1:20–24)
32. Either reptiles or dinosaurs evolved into birds. More than 100-million years later, 60-million years after the dinosaurs became extinct, man evolved.	Birds were created before dinosaurs, reptiles, and other beasts of the Earth. (Gen 1:20–25) Man saw and wrote about dinosaurs and giant marine reptiles. (Job 40:15–41:34)
33. Fish evolved hundreds of millions of years before birds and fruit trees. The first fish and birds came from eggs.	Fruit trees were created before fish. Fish and birds were created on the same day. Fish were created swimming, and birds were created flying. (Gen 1:11, 21–22)
34. It is uncertain which came first, the chicken or the egg.	Eggs were within the first chickens, so both came together. All animals were created fully formed and functional. ¹²
35. The first animals were microscopic sea creatures. Much later, fish evolved, then amphibians, and finally mammals. The last mammals to evolve included whales.	The first animals created included highly developed mammals, such as the great whales. The next day, many other creatures, including so-called “lower forms” were created. (Gen 1:20–21, 1:24)
36. For hundreds of millions of years before man evolved, many animals were carnivores (meat eaters).	Early animals were herbivores (plant eaters). After either the fall or the flood, some became carnivores. (Gen 1:30)
37. Macroevolution continues today, so creation is a long process.	Creation was a distinct event. (Ps 148:5) God finished “ <i>all His work</i> ” in six days. (Gen 2:1–3; Ex 20:11, 31:17; Heb 4:1–11)
38. Everything in nature, from protons to planets to people, evolved by slow, continuous processes.	Everything in nature was created in discrete steps. (Ps 33:6–9) Five times Genesis states that “ <i>God said ... and it was so</i> .” (Gen 1:6–7, 1:9, 1:11, 1:14–15, 1:24) All the Bible's miracles occurred quickly, including the biggest and first miracle—creation.
39. Evolution works, in part, through a process called “survival of the fittest.” Violence, pain, and death were necessary for animals to become more complex. Suffering, cruelty, and death are natural results of the evolutionary process. In this sense, death produced man.	God is all-powerful and does not need to use violence, pain, or death to create. God did not author evil, suffering, disease, or calamity. Several attributes of our Creator are love, peace, and joy. Right after the creation, everything was “ <i>very good</i> .” (Gen 1:31) Suffering and cruelty entered the world when Adam sinned. (Gen 3) In this sense, man produced death. (Gen 2:17, Rom 5:12, I Cor 15:21)
40. Females evolved before males.	Males and females within a “ <i>kind</i> ” were created on the same day. (Gen 1:20–25) The first human male came before the first human female. (Gen 2:22)
41. Man evolved from a lower animal.	Adam was formed from dust. (Gen 2:7)

Theistic Evolution	The Biblical Account
42. Man is a product of nature. Man is controlled and shaped by his environment. In fact, the environment largely determined how man evolved.	God told man to control his environment—to care for the Earth and have dominion over every living thing that moves on the Earth. (Gen 1:26, 1:28–30)
43. Man is an animal that has evolved a little higher than the apes.	Man, who was given dominion over all animals, was created in the image of God. (Gen 1:26–27, 1:30, 5:1) Man was made “a little lower than God.” (Ps 8:5)
44. Man has existed during only the past 1,000th of the Earth’s history—13,000,000,000 years after the universe began and 4,500,000,000 years after the Earth evolved.	Man has existed since the creation week. (Mt 19:4; Mk 10:6, 13:19; Lk 11:50–51a; Jn 8:44; Rom 1:20)
45. There really was no one individual we can call “Adam”; the term refers to “mankind” or a race of primitive men. Adam and Eve may be mythical characters in a saga explaining how evil originated—or characters in a timeless myth representing the sinful choices we all make.	Inspired writers of both Testaments spoke of Adam as an individual, not as a race of people. (Gen 5:3; I Chron 1:1; Lk 3:38; Acts 17:26; Rom 5:12; I Cor 15:21–22, 15:45–47) Eve was also a unique person. (I Cor 11:8–9, I Tim 2:13–14) Regardless of skin color or where we live on this planet, we are all descended from Adam and Eve. (Gen 3:20)
46. Almost all fossils formed before man appeared on Earth.	Man was created before any fossils formed.
47. Man’s genealogy includes many apelike animals. It spans more than a hundred thousand generations. Adam had millions of years’ worth of ancestors.	Man’s genealogy begins with Adam and Eve and involves only a few hundred generations. The Bible gives the line of descent from Adam to Noah and even up to historical times. (Gen 5, I Chron 1, Lk 3:23–38) Christ never mentioned any ancestors of Adam; Adam had none. (Mt 19:4)
48. Although apes, man’s closest relatives, have no difficulty or pain in giving birth, human childbirth is painful and can be dangerous for mother and child. Natural selection should have eliminated women with narrow birth canals. ¹³	Humans are a special creation; they did not descend from apes or any ancestor of apes. Pain in human birth greatly increased as a result of the fall. (Gen 3:16)
49. God breathed a spirit into an apelike creature. It became man.	God breathed the breath of life into a lifeless human body. He became man. (Gen 2:7)
50. The earliest people were meat eaters. The first animals that could be considered human were hunters. Hundreds of thousands of years later, man began farming.	The earliest people were vegetarians. (Gen 1:29) The first man, Adam, was a gardener. (Gen 2:15) Later, Adam became a farmer; his son, Abel, was a herdsman. (Gen 4:2) Less than 10 generations later, man began hunting. (Gen 9:3)
51. Because man evolved from the animals, there is very little difference in the psychological makeup and behavior of animals and man.	Man was created distinct from the animals and in the image of God. (Gen 1:26–27, 5:1) Adam did not find any animal that was physically and emotionally compatible with him. Only another human, Eve, was a satisfactory counterpart. (Gen 2:20)
52. The first man came from a woman. Woman, like man, evolved from animals. The story of Eve being formed by “divine surgery” from Adam’s side is nonsense. Eve had a mother.	The first woman came from a man. (Acts 17:26, I Cor 11:8) Eve was specially created—taken from the side of Adam. (Gen 2:21–23) Eve had no mother.
53. Marriage, a cultural convention, evolved from human experience. Marriage therefore changes as culture evolves.	Marriage is a permanent bond instituted by God. (Gen 2:24)
54. Man slowly developed our basic units of time: a day, a week, a month, and a year.	Genesis 1, not man, explains the origin of our basic units of time.
55. No one established the seven-day week. It was culturally derived. Surprisingly, almost all known cultures throughout history have had a seven-day week.	God established the seven-day week for man’s benefit. (Mk 2:27) It reminds us of His activity and rest during the creation week. (Gen 1, Ex 20:8–11)
56. The Garden of Eden is a myth.	Eden was a literal place. (Is 51:3; Ezek 28:13, 36:35; Joel 2:3)
57. People have rarely lived beyond 100 years, especially in the primitive past.	Before the flood, conditions were such that at least the people listed in chapter 5 of Genesis lived to be about 900 years old. [See pages 510–512.]
58. Lunar months may have been mistakenly called “years” by the early Hebrews. Thus, the patriarchal ages (typically 900 “years”) in Genesis 5 could be much younger in true years.	Two patriarchs were 65 years old when their sons were born. (Gen 5:15, 5:21) If those “years” were lunar months, then they had children when they were 5 years old!
59. Language evolved slowly; it began with grunts and signs of emotion. (Most linguists admit they do not know how languages multiplied. Today, languages are rapidly becoming extinct.)	Adam, who was created with a large vocabulary, conducted intelligent conversations from the beginning. He named many, but not all, land animals on the day he was created. (Gen 2:18–24) Languages multiplied suddenly at Babel. (Gen 11:1–9) [See “Language” and “Speech” beginning on page 8.]
60. Early man was quite primitive and technologically immature.	Within only a few hundred years after the creation, man built musical instruments and refined alloys. (Gen 4:21–22) Early man also had the technology to build Noah’s Ark (Gen 6:14–16) and the Tower of Babel. (Gen 11:3–6)

Theistic Evolution	The Biblical Account
61. The genealogies listed from Adam to Joseph contain many gaps. Each gap may span centuries. The first humans evolved from some apelike animal about 6,000,000 years ago.	The genealogies from Adam to Joseph are tightly linked, because each patriarch's age is given when the next named patriarch was born. [See page 504.] Therefore, more time cannot be inserted between patriarchs. Besides, placing several centuries between each patriarch would push back Adam's creation less than 100,000 years.
62. Cain, Adam and Eve's first son, was banished to a distant land and would not have had a wife, unless he married a subhuman primate or another evolved human.	Adam and Eve had many sons and daughters. (Gen 5:4) Cain probably married a sister or a niece. ¹⁴
63. For a billion years, millions of species have slowly improved and become more complex. This is still happening. New forms of life are always evolving.	God did not need a billion years or a bloody, cruel, inefficient process like evolution (consisting primarily of mistakes) to create. Right after the creation, God saw all that He had made, and it was "very good." (Gen 1:31) After the fall, things deteriorated (Gen 3:16–19, Rom 8:18–22) and diversified. We have never seen a new kind of life evolve. (Ex 20:11)
64. Death entered the world just after the simplest form of life evolved—a billion years before man evolved.	Death entered the world after Adam was created and sinned. (Rom 5:12)
65. Death preceded the activities that some people call sin. ¹⁵	Sin preceded death. (Gen 2:17, 3:1–24; Rom 5:12, 6:23, I Cor 15:21)
66. Adam's fall had only spiritual consequences.	Adam's fall had both spiritual and physical consequences. (Gen 2:17, 3:14–24; Rom 8:18–22; I Cor 15:21–22) [See Table 37 on page 542.]
67. Ever since plants evolved, some have been poisonous. This enhanced their survivability.	Before the fall, every green plant was edible. (Gen 1:29–30)
68. Thorns and thistles evolved along with plants.	Adam's sin caused thorns and thistles. (Gen 3:17–18)
69. Man's wickedness is a result of his animal nature.	Since the fall, man's wickedness is a result of his fallen nature.
70. God gave Adam a spirit, so Adam was the first primate who could be called human. He died physically as did his primate ancestors, but not as a penalty for disobedience. Adam's penalty for disobedience was only spiritual death—separation from God.	The first Adam brought physical and spiritual death into the world for humans. The last Adam (Jesus Christ) brings spiritual life and physical resurrection from the dead. If Adam's body evolved from an animal, this profound theological correspondence is broken, along with the "plan of redemption." ¹⁶ Both "Adams" had miraculously created bodies, but both could die as a penalty for human disobedience. (Rom 5:14–15, I Cor 15:45)
71. Struggle and death preceded man's arrival on Earth. This struggle has continued ever since.	The completed creation, which included man, was "very good." (Gen 1:31) There was no struggle and death. Later, man (by his willful disobedience) fell from this universal paradise, causing struggle and death to enter the world. Someday, this paradise will be restored as a "new heaven and a new Earth." (Is 11:6–9, Rev 22:2–3)
72. Man is continually improving—physically, mentally, socially, morally, and spiritually.	Since early times, man has advanced technologically. (Gen 4:21–22) This was largely inevitable. (Gen 11:6) However, man has regressed physically and spiritually. (Gen 3, 5, 11)
73. Because man culminates billions of years of upward progress, his well-being and continued improvement must be our greatest concern. ¹⁷	Because God created man (and everything else), God should be our greatest concern. Man, who was made in the image of God, was given dominion over all other creatures. (Gen 1:26) Man must exercise great care and concern for the creation, especially for his fellow man. However, humans are special creatures who have sinned and, therefore, need a Savior. (Jn 3:16)
74. People living in biblical times did not have the scientific knowledge to understand how the universe, Earth, and all life evolved. Therefore, Jesus did not try to clarify the allegorical statements and misleading history presented in the scriptures (especially Genesis 1–11). All New Testament and many Old Testament writers were equally misinformed. From our scientific vantage point today, we must seek the real intent behind Christ's words and not take the Bible literally.	Jesus always spoke the truth; in fact, He said He was the truth (Jn 14:6), and scripture is the truth (Jn 17:17). Certainly, Jesus knew the truth, because He was there in the beginning, and all things came into being through Him. (Jn 1:3) To say that Jesus knew the Bible contained false history, but didn't want to tell people the truth, belies who Jesus was. He didn't hide false ideas; He exposed them. He called the Old Testament writers, including Moses, who compiled Genesis 1–11, prophets. (Jn 5:46–47) By definition, prophets, when speaking God's message, always spoke the truth. False prophets were stoned to death. Jesus was not constrained by culture, tradition, or concern of misunderstandings (Mt 5:1–12, Jn 6:53). Nor did He avoid subjects that were hard for listeners to understand, such as: end-times (Mt 24), the new birth (Jn 3:1–12), His crucifixion (Mt 12:40, Mk 8:31), or what follows death (Mt: 25:32–46, Jn 14:2). As explained in Table 38 on page 554, Jesus specifically referred to accounts in each of the first seven chapters of Genesis, something He would not have done if He knew they were not historical events. If we replace Jesus' words with our ideas and claim they were "His real intent," we can seemingly justify almost anything.

Sin and Death

Christians have different understandings of what kind of death began after Adam sinned, because different verses *taken in isolation* can support different conclusions. Also, imagining conditions before the Fall is difficult. Perhaps that is why so many allegorize the story to some extent. However, doing so risks losing important meaning. Here, we will systemically examine the main Bible verses that provide clues. These verses are in the left-hand column of [Table 37](#).

Contrast each interpretation (columns A-D) with the passage in each row. Add additional columns or Bible verses that you feel pertain, then decide what type of death you think began at the Fall. My subjective judgments, coded in green, yellow, and red circles (reminiscent of a traffic light's go, caution, and stop) can provide a starting point for your evaluation. Numbers in some cells correspond to endnotes that begin on [page 544](#).

Table 37. What Kind of Death Began When Adam Sinned?

Scripture References	A Sin brought only spiritual death to man (separation of man from God). Physical death was built into the creation before the fall.	B Sin brought physical and spiritual death only to humans.	C Sin brought physical and spiritual death to humans and physical death to animals.	D Sin brought physical and spiritual death to humans and physical death to animal and plant life.
Genesis 1:30. And to every beast of the earth and to every bird of the sky and to everything that moves on the Earth which has life, I have given every green plant for food;			● 18	⊗ 19
Genesis 1:31a. And God saw all that He had made, and behold, it was very good.	⊗ 20	⊗ 20	● 20	
Genesis 2:17. But from the tree of the knowledge of good and evil you shall not eat, for in that day ... you shall surely die.	⊗ 21			
Genesis 3:4. And the serpent said to the woman, "You surely shall not die."	⊗ 22			
Genesis 3:16–19. [You will now have many physical problems] till you return to the ground [as dust].	⊗ 23			
Genesis 3:22. Then the Lord God said, "Behold, the man has become like one of Us, knowing good and evil; and now, lest he stretch out his hand, and also take from the tree of life, and eat, and live forever."	⊗ 24	● 24	● 24	⊗ 25
Romans 5:12. Therefore, just as through one man sin entered into the world, and death through sin, and so death spread to all men, because all sinned.	⊗ 26	● 27	● 27	● 27
Romans 8:10. ... the body is dead because of sin, yet the spirit is alive because of righteousness.	⊗ 28			
Romans 8:20–22. ... For the creation was subjected to futility ... the whole creation groans and suffers ...	⊗ 29	⊗ 30	● 30	● 30
I Corinthians 15:21–22. For since by man came death, by a man also came the resurrection of the dead. For as in Adam all die, so also in Christ all shall be made alive.	⊗ 31			
I Corinthians 15:45. [Christ was the second Adam.]	⊗ 32			
Revelation 21:1–4. {There will be a new heaven and a new Earth. Things will be restored to the conditions before the Fall.} ... there shall no longer be any death; there shall no longer be any mourning, or crying, or pain;	⊗ 33	⊗ 33	● 33	⊗ 34

Other Thoughts on Sin and Death. It is difficult to imagine a time when animals did not die, that an elephant would never have accidentally stepped on and killed an ant, or that microscopic organisms weren't accidentally ingested by larger animals. Accidental death may have been different from the inevitable death of a slowly malfunctioning body.

We all wonder whether the fangs of a lion either did not exist prior to the Fall or, if they did, were not used to tear flesh. However, Genesis 1:30 states that all animals could eat plant food after the creation. While that may seem strange, during World War II, when meat was scarce, the London zoo fed its lions vegetation and they did just fine.

Having examined the many contradictions between theistic evolution and the biblical view of life and history, one should consider the following question:

*If God is not limited in power and could have created the world, if He has given man a record of what He did, and if the scientific evidence does not contradict it, then what prevents you from believing that it actually happened?*³⁵

If evolution happened, then death was widespread before man evolved. But if death preceded man and was not a result of Adam's sin, then sin is not the cause of death—so we do not need a Savior.

References and Notes

1. The day-age theory claims that *each of the six creation days was a long age*.
2. The framework theory claims that *the six creation days are a literary device—a **framework** in which similar creation events happened over long ages*. Supposedly, the creation days are not chronological, and the parallel nature of some events of Days 1 and 4, Days 2 and 5, and Days 3 and 6 show that Genesis 1 is not literal history.
3. The revelation theory maintains that *in six days, God **revealed** to Adam what He created over vast ages*. For details, see P. J. Wiseman, *Creation Revealed in Six Days* (London: Marshall, Morgan & Scott, Ltd., 1948).
4. Progressive creation maintains that God created, but He did so *over billions of years, in many short, miraculous, **progressive** steps*.
5. Barr's letter, sent to David C. C. Watson, was dated 23 April 1984.
6. This format and some of the ideas were suggested by Richard Niessen's article "Several Significant Discrepancies between Theistic Evolution and the Biblical Account," in *The Creation Research Society Quarterly*, Vol. 16, March 1980, pp. 220–221.
7. If each effect had a cause that also had a cause, an infinite chain of events would stretch back in time—with no beginning. Philosophically, one must accept either (a) this infinite regression or (b) an infinite God. Scientifically, one can conclude that there was a beginning; that is, no infinite regression. [See "**A Beginning**" on page 32 and "**Second Law of Thermodynamics**" on page 32.] Biblically, one needs to read and believe only the first three words of the Bible (the title of this book)—a far simpler task.
8. Those holding this widespread belief never explain to whom the Sun appeared. Humans, according to these theistic evolutionists, arrived several billion years later.
9. Claiming that the word "made" (Hebrew: *asah*) in Genesis 1:16 really means "made to appear" is a deceptive play on words and is not supported by the Hebrew. Every major Bible translation says the Sun, Moon, and stars were **made** on Day 4. Had "made to appear" been intended, as when "*God said, ... let the dry land **appear***" (Gen 1:9), the Hebrew *raah* would presumably have been used.
9. The Hebrew word for "waters" (*mayim*) in Genesis 1:2 is used 574 times in the Bible. It always means *liquid* water, not ice, steam, or a cloud.
10. Some advocates of the day-age theory say that the light of Genesis 1:3 sustained plants until the Sun appeared an age later. While sunlight produces photosynthesis, light, in general, does not. For example, light from an ordinary light bulb will not grow plants shielded from all sunlight. Special light bulbs, designed to grow plants, must closely match the Sun's spectrum across all colors and into the infrared and ultraviolet wavelengths. Some plants, such as tomatoes and strawberries, even have difficulty growing under such bulbs. For most plants, the light must have a day-night cycle. Some plants also need light with seasonal cycles to produce changes from one stage of growth, such as budding to blooming, to another stage. (This means the Earth's axis must be appropriately tilted relative to Earth's orbital plane.) If the distance between the plant and light source varies too much, the changing light intensity will harm the plant. The most obvious way for a light source to satisfy all these requirements is for it to correspond to the Sun's location, brightness, and spectrum—in other words, for the light to come from the Sun. [See Young Hun Song et al., "FKF1 Conveys Timing Information for CONSTANS Stabilization in Photoperiodic Flowering," *Science*, Vol. 336, 25 May 2012, pp. 1045–1049.] To understand better the light of Genesis 1:3, see "**If the Sun and Stars Were Made on Day 4, What Was the Light of Day 1?**" on pages 460–461. Theistic evolutionists do not say what the light of Genesis 1:3 was, what its characteristics

were, or where it originated. Therefore, they do not know if it could have sustained all plant life and kept the Earth at just the right daily and seasonal temperatures for “three ages” (hundreds of millions of years) until the Sun “took over.” Did the light of Genesis 1:3 just “switch off” when the Sun was made during “the fourth age”? Remember, to most theistic evolutionists the “six ages” lasted 4,500,000,000 years.

Even if the absence of sunlight for “an age” were not a problem for the day-age theory, the absence of animals for two “ages” is a fatal problem. Animals produce the carbon dioxide plants require, and insects are important for fertilizing flowering plants. Insects, other animals, and the Sun must have existed within days or weeks of the first plants.

11. The literal Hebrew actually says that “*all* the high mountains under *all* the heavens” were covered with water. This double use of “all” (Hebrew: *kaal*), while redundant in our language, emphasized the universality of the flood in Hebrew.
12. “Genesis 1 repeats 10 times the phrase “[they will reproduce] *after their kind*.” Common sense also affirms it. Obviously, only chickens come out of chicken eggs, and only chickens lay chicken eggs. This raises the classic paradox: Which came first, the chicken or the egg? The answer may surprise you.

Most of us know that baby girls are born with hundreds of eggs. (Recent research shows that mammal ovaries regulate the production of even more precursor egg cells in the mammals’ bone marrow.) So, female vertebrates—animals with backbones, such as birds, mammals, fish, reptiles, and amphibians—are born with many potential eggs. (Some fish may be exceptions. Researchers are working to clarify this.) Therefore, with the first chicken came the first eggs. Neither came first; both arrived together. Paradox solved.

Only evolutionists face this paradox. It disappears when one understands life’s amazing complexity that only an infinitely powerful and intelligent Creator could produce.

13. Joshua Fischman, “Putting a New Spin on the Birth of Human Birth,” *Science*, Vol. 264, 20 May 1994, pp. 1082–1083.
14. Was it improper for brothers and sisters to marry? In many countries today, close intermarriages are discouraged or prohibited by law, because they often produce genetic defects in children. For example, children have a 4.4% greater chance of dying before age ten if their parents are first cousins. This includes late miscarriages, six months or more after conception. [See Kevin Davies, “Cost of Consanguinity,” *Nature*, Vol. 371, 13 October 1994, p. 630.]

Damaged genes, which are usually caused by radiation and other adverse environmental factors, have steadily accumulated in humans since the time of Adam and Eve. Most defective genes are not immediately harmful, because each person usually has a good corresponding gene from the other parent. However, closely related parents have a much greater chance of having inherited the same damaged gene from their common ancestor. If their child then receives this defective gene from both parents, abnormalities usually result.

Because damaged genes accumulate with time, Adam and Eve’s children and grandchildren probably had few genetic

defects. (Genesis 1:31) Therefore, close intermarriages would not have had today’s medical consequences. The biblical prohibition forbidding incest was introduced when Moses was inspired to write Leviticus 18:6–18.

15. Some atheists understand this better than most theists. G. Richard Bozarth, writing in *The American Atheist*, stated:

Christianity has fought, still fights, and will fight science to the desperate end over evolution, because evolution destroys utterly and finally the very reason Jesus’ earthly life was supposedly made necessary. Destroy Adam and Eve and the original sin, and in the rubble you will find the sorry remains of the son of god [sic]. Take away the meaning of his death. If Jesus was not the redeemer who died for our sins, and this is what evolution means, then Christianity is nothing!

 G. Richard Bozarth, “The Meaning of Evolution,” *The American Atheist*, Vol. 20, February 1978, p. 30.
16. For a fuller discussion of this profound subject, see Arthur C. Custance, *Two Men Called Adam* (Brockville, Ontario: Doorway Publications, 1983). At one point (p. 250), Custance summarized the issue as follows:

The bond between ... [Adam and Christ] is entirely predicated on a miraculous origin in both cases: the creation of the first man Adam, which was clearly a supernatural event; and the virgin conception of the Last Adam, which was also clearly a supernatural event.

A body of animal origin acquired by evolutionary processes is an entirely different thing from a body of divine origin acquired by direct creation. As to the former, it is clear that such a body must by nature be subject to death, the ancestral line being through some primate channel where death is natural. As to the latter, such a body becomes subject to death not by nature but only as a penalty.

The whole Plan of Redemption hinges upon this difference because the Last Adam cannot by nature be subject to death and still make a truly vicarious sacrifice of Himself. He would merely be paying a debt to nature before the expected time.
17. This is the basic tenet of secular humanism—a belief system that generally dominates our media and tax-supported schools. Most subscribers to this atheistic philosophy are unaware of its evolutionary roots, its definition, or its implications. The U.S. Supreme Court declared that secular humanism is a religion. (*Tercaso v. Watkins*, 367 U.S. 488, 1961, note 11.)
18. Conditions were quite different before the Fall. Animals ate plant life and did not need to prey upon each other. After the Fall, some animals became food.
19. “*Plants cannot literally die in the biblical sense of the word, because they are not literally alive in the biblical sense. The Bible uses the phrase ‘nephesh chayah’ to refer to living creatures. The term is applied to humans (Genesis 2:7), and animals (Genesis 1:21, 24) but never to plants. Biologists today use a somewhat different definition of life than the Bible does. But biblically, plants are not truly alive and hence they do not literally die. Plants are self-replicating food that*

God made for the living creatures (Genesis 1:29–30)."

Jason Lisle, "Answering Dr. Norm Geisler's Comments on Genesis," <http://www.youroriginsmatter.com>.

20. The creation (all that God made) was not just "good," it was "very good." It is hard to reconcile this statement with the ruthless killing we observe today by carnivores. The only explanation seems to be that animals did not kill or eat other animals before the Fall.
21. Before the Fall, God warned Adam that, *in the future*, if he ate from one tree, he would surely die. Therefore, death (for humans, in this verse) was not present at that time.
22. The serpent tried to convince Eve that humans would not die. Apparently, Eve had no first-hand reason to believe that humans would die—or she did not know or believe God's warning to Adam.
23. Adam's sin obviously had physical consequences for humans. Thorns grew for the first time; pain in childbirth began. Eating plants (the only source of food for man and animals at that time) would now require strenuous physical labor. Eventually, Adam's body would return to dust.
24. "Live forever" implies something that is physical, not just spiritual. Presumably, only man could have eaten from the tree of life and have lived forever. This may not have applied to animals, since there is no mention that animals were removed from the Garden of Eden. Certainly sea creatures and plants could not have eaten from the tree of life.
25. Obviously, plants were not able to eat of the tree of life. Therefore, plants were unable to live forever before the Fall.
26. Death resulted from the action of a man after the creation. It was not imposed upon the creation prior to Adam's sin.
27. "... death spread to all men ..." A possible implication is that death was confined to humans and did not include animals and plants.
28. Sin produced something more than just spiritual death. The original Greek text clearly states what is meant by "body" and "dead." The word for "body" is used for Christ's dead body (Luke 23:55); the word for "dead" is used for Christ's dead body (Romans 8:11). It is also clear that Christ's resurrected body was of "flesh and bones" (Luke 24:39).
29. Speaks of physical (as opposed to spiritual) sufferings.
30. The Fall affected the *whole* creation, not just humans, not just living organisms, and not just the Earth.
31. The type of death Adam produced is directly parallel to the death of Christ on the cross—physical and spiritual. Death did not precede Adam's creation. The parallel is also between Adam's sin which brought *physical* death and Christ's atonement which permits a *physical* resurrection.
32. See Endnote 16 on page 544.
33. Christ revealed through John that there will be a new heaven and a new Earth—a time when there will be no pain, crying, or death (presumably for humans and animals)—a restoration of conditions that existed before the Fall.
34. Plants do not morn, cry, or feel pain.
35. Malcolm Bowden, *The Rise of the Evolution Fraud* (San Diego: Creation-Life Publishers, 1982), p. 167.

What Questions Could I Ask Evolutionists?

Here are categories of questions that you could ask. The page numbers below will show why evolutionists avoid these questions. If you find evolutionists who feel they or others can answer them, then ask one more question: "Why won't evolutionists enter a strictly scientific debate on the creation-evolution issue?" For details on two debate offers, see pages 570–571.

1. Where has macroevolution ever been observed? [See page 5.] What is the mechanism for getting new complexity, such as new vital organs? [See pages 5–7.] If any of the thousands of vital organs evolved, how could the organism have lived before getting the vital organ? (Without a *vital* organ, the organism is dead—by definition.) If a reptile's leg evolved into a bird's wing, as evolutionists claim, wouldn't the leg become a bad leg long before it became a good wing? How could metamorphosis evolve? [See page 19.]
2. Living things are incredibly complex, so how could chance or natural processes produce organs as complex as the eye, ear, or brain of even a tiny bird? [See "Complex Molecules and Organs" on page 7. Also see pages 14–25.]
3. Motors do not work until each radically different component is completely developed, in its precise place, and a compatible energy source is available. So how could a bacterial motor evolve? [See page 23.]
4. If macroevolution happened, where are the billions of transitional fossils that should be there? Billions! Not a handful of questionable transitions. Why don't we see a smooth continuum among all living creatures, or in the fossil record, or both? [See page 12.]
5. Textbooks show an evolutionary tree, but where is its trunk and where are its branches? For example, what are the evolutionary ancestors of the insects? [See page 12.]
6. If it takes intelligence to make an arrowhead, why doesn't it take vastly more intelligence to create a

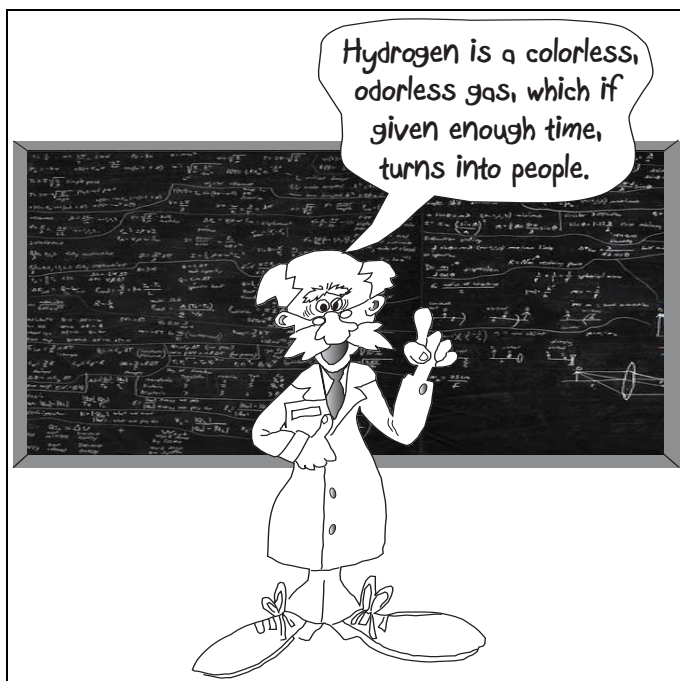

Figure 252: Unbelievable. This quotation by the late cosmologist Edward Robert Harrison and cartoon by Professor George Mulfinger sums up the belief of most evolutionists. They think that a big bang, 13.8-billion years ago, brought the universe into existence and initially produced hydrogen, the simplest chemical element. Hydrogen then evolved into other chemical elements—and eventually people.

human? Do you really believe that hydrogen will turn into people if you wait long enough?

7. How could the first living cell begin? That is a greater miracle than for bacteria to evolve into man. How could that first cell reproduce? [See page 15.] Speaking of reproduction, how could sexual reproduction evolve? [See page 20.] Before life appeared, did the atmosphere have oxygen or did it not have oxygen? Whichever choice you make creates a terrible problem for evolution. Both must come into existence at about the same time—in other words, by creation. [See page 14.]
8. Can you describe any natural process that creates information? What evidence is there that information, such as that in DNA, could ever assemble itself? What about the 4,000 books' worth of coded information that are in a tiny part of each of your 100 trillion cells? If astronomers received an intelligent signal from some distant galaxy, most people would conclude that it came from an intelligent source. Why then doesn't the vast information sequence in the DNA molecule of just a bacterium also imply an intelligent source? [See pages 9 and 17.]
9. Why is the ratio of ^{235}U to ^{238}U constant in uranium ore deposits worldwide? What is the origin of the heaviest known chemical element, Proto-Uranium? [See page 409.]
10. Which came first, DNA or the proteins needed by DNA, which can only be produced by DNA? [See page 18.]
11. How could immune systems evolve? [See page 22.]
12. Since 2,000 genes are indispensable for human life, how did each gene evolve before all 2,000 genes were in place and functioning? Obviously all were created simultaneously. [See page 17.]
13. If the solar system evolved, why do three planets spin backwards? Why do at least 30 moons revolve backwards? [See page 27.]
14. Can you name one reasonable hypothesis for the Moon's origin—any hypothesis that is consistent with all the data? Why isn't the public told the scientific reasons for rejecting all the evolutionary theories for the Moon's origin? What about the almost 200 other moons in the solar system? [See page 29.]
15. Why is Saturn's cold moon, Enceladus, still ejecting hot water into space if it is millions of years old? [See page Figure 189 on page 346.]
16. Where did matter, space, time, energy, or even the laws of physics come from? [See page 31.] What about water? [See page 27.]
17. The gravity of a black hole is so strong that nothing, not even light, can escape it. How then did all matter in the universe escape the singularity of the big bang—an infinitesimal point? [See pages 439–453.]
18. How were the heavy elements from iron to uranium made? Physicists recognize that fusion in stars—even exploding stars—cannot produce these heavy elements. [See Endnote 33 on page 142.] How could stars evolve? [See pages 32–34.]
19. What are dark matter and dark energy? [See page 33.]
20. Why are dormant, but living, bacteria found inside rocks that you say are hundreds of millions of years old and in meteorites that you say are billions of years old? Clean-room techniques and great care were used to rule out contamination. [See page 38.] The DNA in those bacteria also rules out contamination. [See Endnote 104 on page 372.]
21. Do you know that most scientific dating techniques support a young Earth, solar system, and universe? [See pages 36–43.] Are you aware of all the assumptions and contradictory evidence used by those who say the Earth is billions of years old? [See pages 39–43, 454–459, and 379–433.]

22. Why do so many ancient cultures have flood legends? [See page 49.] How do you explain the seashells found atop every major mountain range on Earth? [See page 49.]
23. Have you heard about the mitochondrial Eve and the genetic Adam? Scientists know that mitochondrial Eve was the common female ancestor of every living person, and she appears to have lived only about 6,000–7,000 years ago. [See pages 534–536.]
24. Careful researchers have found the following inside meteorites: living bacteria, salt crystals, limestone, water, sugars, terrestrial-like brines, and earthlike isotopic patterns. Doesn't this suggest that Earth was their source? [See page 351.]
25. What successful predictions have been made by the theory of evolution? [See “**predictions of evolution**” in the index. Haven't they all failed?] Are you aware of the successful predictions made by the hydroplate theory? [See the 58 “**predictions of the hydroplate theory**” on page 468 and in the index.] The bolded entries have been recently confirmed. Pages 308 and 318 explain the predicted discoveries made by the *Deep Impact* and *Stardust* space missions to comets in 2005.]
26. Why are more than 400 large lakes in Antarctica not completely frozen? (One lake, Lake Vostok, is the sixth largest lake in the world and has the volume of Lake Michigan.) How could a lake even begin in Antarctica? Why would it stay unfrozen for so long? [See “**Antarctic Lakes**” on page 498.]
27. Why is a large lake, filled with *liquid* water one-mile under the surface of Mars? Where did the water come from, and why hasn't it frozen? [See page 355.]
28. Can you explain the origin of the following 26 features of the Earth and solar system? (Page numbers below refer to entire chapters devoted to that subject. Use the index of this book to locate other pages.)
- ◆ The Grand Canyon (pages 215–257)
 - ◆ Mid-Oceanic Ridge
 - ◆ Earth's Major Components
 - ◆ Ocean Trenches, Earthquakes, and the Ring of Fire (pages 153–192)
 - ◆ Magnetic Variations on the Ocean Floor
 - ◆ Submarine Canyons
 - ◆ Coal and Oil
 - ◆ Methane Hydrates
 - ◆ Ice Age
 - ◆ Frozen Mammoths (pages 267–299)
 - ◆ Major Mountain Ranges
 - ◆ Overthrusts
 - ◆ Volcanoes and Lava
 - ◆ Geothermal Heat
 - ◆ Strata and Layered Fossils (pages 195–213)
 - ◆ Limestone (pages 260–266)
 - ◆ Ore bodies (page 600)
 - ◆ Metamorphic Rock
 - ◆ Plateaus
 - ◆ Slot canyons (Figure 142 on page 238)
 - ◆ The Moho and Black Smokers
 - ◆ Salt Domes
 - ◆ Jigsaw Fit of the Continents
 - ◆ Changing Axis Tilt
 - ◆ Comets (pages 301–335)
 - ◆ Asteroids, Meteoroids, and TNOs (pages 337–374)
 - ◆ Earth's Radioactivity (pages 379–433)
29. Tablemounts are flat-topped volcanic cones that lie 3,000–6,000 feet below sea level. How were their tops planed off? If sea level was lower by that amount, where did the water go? If the seafloor was higher by that amount, where did the rock below the floor go so the floor could subside? [See page 169.]
30. What produced the Ring of Fire around the Pacific, and why is that ocean so large? [See pages 156–157.]
31. Why are whales fossilized high in the Andes, along side giant sloths? [See “**A Whale of a Tale**” on page 137.]
32. How can a continental size, crustal plate that is 30–60-miles thick dive into the mantle? What would initiate the dive? Why doesn't friction or the blunt end of the plate prevent subduction? [See page 176.]
33. To form the Grand Canyon required the removal of almost 3,000 cubic miles of dirt. *Where did all that dirt go?* If the Colorado River carved the Grand Canyon as almost every book on the subject claims, the largest river delta in the world should be where the Colorado River enters the Gulf of California. Why is the actual delta so tiny? [See pages 215–257.]
34. The Americas have an approximate jigsaw fit with Europe and Africa. If these continents were once joined, what broke them apart, and how did they move to their present locations? [See pages 111–151.]
35. Where is Earth's radioactivity? What produces the parentless polonium halos? How can chondrules be explained? [See pages 379–433.]
36. Why do comets contain layers upon layers of well-rounded rocks typically 10 feet in diameter? [See Figure 184 on page 340.]
37. Explain the forces, energy, and mechanism that moves tectonic plates? Why do they generally move toward the western Pacific? Why do these plates sometimes move backward? Why do some earthquakes occur internal to tectonic plates? What produced most of the faults within the Earth? How did the Earth develop its inner and outer core? [See pages 603–606.] Why is Earth's magnetic field so large—2,000

times larger than the combined magnetic fields of planets Mercury, Venus, and Mars? Why do seismic waves pass through the inner core much faster when traveling parallel to the axis of the magnetic poles? How could Earth's magnetic field reverse? What

causes geomagnetic jerks (GMJs)? Why does the Earth rotate faster—or slower—with each GMJ? Why do GMJs occur about every 6 years? What produces the magma seen in volcanoes and flood basalts? [For the answers to all these questions, see pages 180 and 181.]

How Can Origins Be Taught in High School or College?

Teaching *scientific evidence* for creation has always been legal in public schools.¹ Yet, many teachers wonder how to do this. Schools should be places of inquiry, where students are taught to analyze all sides of an issue. Few academic subjects have greater inherent interest for high school or college students than the origins question. The fact that it is controversial is, therefore, not a liability but an asset.² The origins question, then, is an ideal vehicle for developing analytical skills.³ An excellent way to develop these skills is “The Origins Research Project.”

The Origins Research Project

Introduction. The Origins Research Project may be one of the most interesting and exciting projects students ever experience. It will demonstrate how scientific inquiry works while building upon one of the most basic and natural questions a person ever asks: “How did everything begin?” Each student is (1) to decide which theory of origins best fits the scientific evidence, and (2) to write a paper explaining why. Religious beliefs, while possibly important to the student's overall conclusion, are not to be a part of this paper. There are no right or wrong answers. Instead, the student's work should be evaluated on its breadth of research, critical thinking, sound logic, and detailed comparisons of the data with the various theories.

The following description of the Origins Research Project is written in a generalized form, so it can be used at the high school or college level in either secular or religious schools. Teachers can tailor this project to the time available, the students' needs, and the teacher's objectives.

Purpose. This project will (1) help each student develop analytical skills in science, (2) integrate many seemingly diverse topics and fields of science into a meaningful, maturing, and exciting investigation, and (3) allow academic study in an important area of science without infringing on diverse religious views that are the prerogative of the individual and the home. Because strongly held views will be presented on both sides of this question of origins, the student will develop, probably for the first time, strong, reasoned, and confident disagreement with some scientific authorities and textbook authors. This experience, which even most scientists and engineers do not have until they are well into their first major research

effort, is one of the most maturing that an education can provide. Unfortunately, the typical classroom experience, especially in the sciences, involves learning or absorbing information, not evaluating evidence and deciding which of several scientific explanations is most plausible.

The Project. Each student will write a paper stating which theory of origins he or she thinks is best supported by the scientific evidence and why. The first sentence of the paper will be, “I believe that the scientific evidence best supports _____.” The blank space, for example, might contain one of the following:

- ◆ the theory of evolution
- ◆ the theory of creation
- ◆ a modified theory of evolution
- ◆ a modified theory of creation

(Possible definitions of “evolution” and “creation” are on page 549. Any student who feels the evidence supports a theory other than evolution or creation should define that theory.) Students should understand that their conclusions, based upon an examination of only some scientific evidence, may differ from their religious views (theism, atheism, or their many variants).

The scope of this project is not to resolve such differences but to learn to examine scientific evidence. Limitations and uncertainties in science, especially when dealing with ancient, unrepeatable events having no observers, will become apparent before the project is completed.

The Role of the Teacher. The teacher's role is (1) to help develop students' analytical skills in science, (2) to prevent religious aspects from entering classroom discussions, (3) to prevent censorship of any scientific evidence, (4) to facilitate discussion, and (5) to challenge and stimulate students' thinking. Teachers should frequently ask thought-provoking questions such as:

- ◆ What assumptions are being made?
- ◆ Can those assumptions be tested?
- ◆ Why do other scientists disagree?
- ◆ What are other explanations?
- ◆ What evidence is there for other conclusions?

The teacher's role is not to compel belief in any theory of origins; nor is it to teach the material. The subject matter is so broad that it would be unreasonable to expect teachers to master it quickly enough to teach it.

Furthermore, most teachers probably have presuppositions that could easily bias a student's decision-making process. Students will frequently ask, sometimes subtly, what the teacher believes. A suggested response is:

Don't be concerned with what I believe. What matters in this class is how thoroughly you examine the scientific evidence on both sides of this issue. I am not interested in your specific conclusion; I am interested only in the thoroughness and logic you use to reach your conclusion. You are on your own.

Teacher Options.

1. Decide the length of the written paper. This decision should be based upon the student's academic level, the scientific fields the student should explore, and the teacher's objectives. For a high school physics, biology, or general science course, 1,000 words might be a minimum. For a college student majoring in science education or geology, 40 typewritten pages might not be sufficient.
2. Determine the beginning and ending dates for the Origins Research Project. The project should be long enough to allow the student to reflect on the subject, to do the depth of reading and library research the teacher desires, and to write the paper. It is suggested that the Origins Research Project span 1–4 months and be finished in time to allow one week for grading. This project can be completed using a minimum of three classroom periods.
3. Specify the writing and grading standards. The required quality of the written paper and its adherence to the school's style manual should be established. Schools that have a well-integrated curriculum may want English teachers to grade the papers from a writing standpoint and science teachers to grade the papers from a scientific standpoint. If, among the teachers available for grading, at least one is an evolutionist and one is a creationist, students could have their papers graded by a teacher who holds their basic view of origins (creation or evolution or both).
4. Establish the weight that will be assigned to this graded project. It should be commensurate with the research effort the teacher desires and the student motivation that will be needed, possibly one-third to one-sixth of the course grade. Some students have been allowed to complete the Origins Research Project instead of taking the final exam.

Resource Materials

Teachers should make available books, videos, and DVDs that will balance the broad range of perspectives concerning origins. If outside speakers are brought into the classroom,

students who favor evolution should question the creationist speakers, and students who favor creation should question evolutionist speakers. Short student debates create great interest.

Questions and Answers

Q1: *Can creation be dealt with scientifically?* [See also “[How Can the Study of Creation Be Scientific?](#)” on page 438.]

A1: Scientists employ a common but special type of reasoning when they try to explain past, unrepeatable events that had no observers. They first develop a model—or what scientists call a “working hypothesis.” This simply describes what they think happened. Alternate explanations must also be defined. Then, evidence is shown that will raise or lower the plausibility of the various possible explanations. There are many possible models of origins. However, the two basic models, creation and evolution, can be defined as follows:

The Creation Model of Origins:

- ◆ Everything in the universe, including the stars, the solar system, the Earth, life, and man, came into existence suddenly and recently, with essentially the complexity we see today.
- ◆ Genetic variations are limited.
- ◆ The Earth has experienced a worldwide flood.

The Evolution Model of Origins:

- ◆ Over billions of years, the universe, the solar system, the Earth, and finally life developed from disordered matter through natural processes.
- ◆ Random mutations and natural selection produced all life from single-celled life.
- ◆ All life has a common ancestor.

Neither creation nor evolution can explain scientifically what happened at the ultimate beginning (represented by the region in red in [Figure 253](#)). The evolution model is completely silent about the origin of matter, space, energy, time, and the laws of chemistry and physics. The farthest back in time most evolutionists claim to go is to a hypothetical “big bang.” They admit that they have no scientific understanding of what preceded such an event. Creationists likewise have no *scientific* understanding of what happened during the creation event. Nevertheless, to the right of the red region, both models can be tested against the evidence. For any assumed starting condition, scientists frequently ask if the laws of physics and chemistry would produce what we see today. These are certainly scientific questions that give us insight into our beginnings.

Q2: *How can those high school students who are underachievers or poorly motivated carry out this project?*

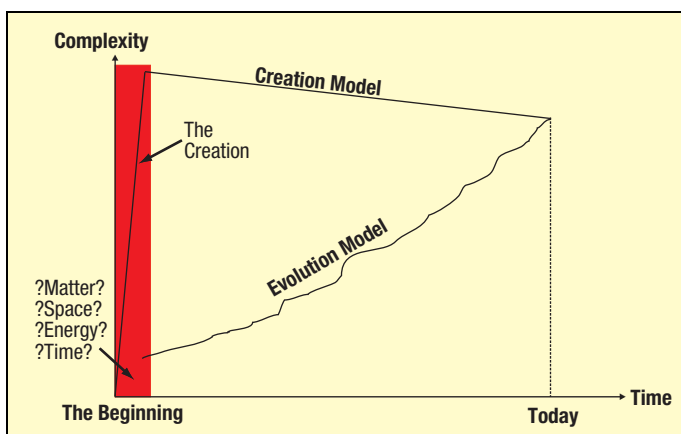

Figure 253: Two Models. Comparison of Creation and Evolution on the Complexity Scale.

A2: Teachers who see students having difficulty may choose to limit them to a narrower topic, such as the fossil record. Students could be asked such questions as:

- ◆ How do evolutionists and creationists explain the fossil record?
- ◆ How are fossils formed?
- ◆ Where are fossils formed today?
- ◆ What details are found in the fossil record?
- ◆ Which explanation best fits these observations?

Answers to these questions could form an outline for a student's paper. If the student requires more guidance, references and page numbers could be included with each question.

Students are often surprised that their conclusions differ from those of some scientists—either creationists or evolutionists. The confidence these students have that their

answers are more credible than those of certain scientists will produce self-confidence and an increased interest in science. Students frequently want to explore other aspects of the origins controversy on their own. Generating this sense of excitement and discovery should be an objective of every science curriculum.

Q3: *What would the minimum project involve at the high school level?*

A3: The following would require only three class periods; they should be spread out over at least three weeks.

Day 1:

- ◆ Pass out the assignment sheets that (1) state the length, format, grading criteria, and due dates for the outline and final 1,000-word paper; (2) define “creation” and “evolution”; and (3) list the resources available in the school library.
- ◆ Describe selected resources.
- ◆ Explain science methodology when dealing with past events that were not observed and cannot be repeated. [See [Figure 253](#).]

Day 2:

- ◆ Students conduct one or two debates.
- ◆ Lead an informal discussion of the issue. Emphasize the importance in science of basing conclusions on evidence.
- ◆ Remind the students when their outlines are due.

Day 3:

- ◆ Comment on the quality of students' outlines.
- ◆ Discuss articles posted on the bulletin board.
- ◆ Remind students when their final papers are due.

References and Notes

1. In 1987, the Supreme Court of the United States held: *Moreover, requiring the teaching of creation science with evolution does not give schoolteachers a flexibility that they did not already possess to supplant the present science curriculum with the presentation of theories, besides evolution, about the origin of life.* “*Edwards, Governor of Louisiana et al. v. Aguillard et al.*,” *Supreme Court of the United States*, No. 85–1513, argued 10 December 1986, decided 19 June 1987, p. 1. Also see the first paragraph of page 8.
 - ◆ On 13 June 2001, the United States Senate passed the following resolution by a vote of 91 to 8.

It is the sense of the Senate that—

(1) *good science education should prepare students to distinguish the data or testable theories of science from philosophical or religious claims that are made in the name of science; and*

(2) *where biological evolution is taught, the curriculum should help students to understand why this subject*

generates so much continuing controversy, and should prepare the students to be informed participants in public discussions regarding the subject. Senator Rick Santorum, *Congressional Record*, Vol. 147, No. 82, 13 June 2001, pp. 1–2. See also Constance Holden, “Senate Gives Nod to Creationists,” *Science*, Vol. 292, 29 June 2001, p. 2429.

- ◆ “*Several benefits will accrue from a more open discussion of biological origins in the science classroom. First, this approach will do a better job of teaching the issue itself, both because it presents more accurate information about the state of scientific thinking and evidence, and because it presents the subject in a more lively and less dogmatic way. Second, this approach gives students greater appreciation for how science is actually practiced. Science necessarily involves the interpretation of data; yet scientists often disagree about how to interpret their data. By presenting this scientific controversy realistically, students will learn how to evaluate competing interpretations in light of evidence—a skill they will need as citizens, whether*

they choose careers in science or other fields. Third, this approach will model for students how to address differences of opinion through reasoned discussion within the context of a pluralistic society.” David DeWolf, as quoted by Senator Rick Santorum, *Congressional Record*, 13 June 2001. p. 2.

- ◆ “I think, too often, we limit the best of our educators by directing them to avoid controversy and to try to remain politically correct. If students cannot learn to debate different viewpoints and to explore a range of theories in the classroom, what hope have we for civil discourse beyond the schoolhouse doors? Scientists today have numerous theories about our world and its beginnings. I, personally, have been greatly impressed by the many scientists who have probed and dissected scientific theory and concluded that some Divine force had to have played a role in the birth of our magnificent universe. These ideas align with my way of thinking. But I understand that they might not align with someone else’s. That is the very point of this amendment—to support an airing of varying opinions, ideas, concepts, and theories. If education is truly a vehicle to broaden horizons and enhance thinking, varying viewpoints should be welcome as part of the school experience.” Senator Robert Byrd, *Congressional Record*, 13 June 2001, p. 6.
2. Richard Alexander, evolutionist and professor of zoology and curator of insects at the University of Michigan, proposed a similar idea.

No teacher should be dismayed at efforts to present creation as an alternative to evolution in biology courses; indeed, at this moment creation is the only alternative to evolution. Not only is this worth mentioning, but a comparison of the two alternatives
- ◆ “We who teach introductory physics have to acknowledge, if we are honest with ourselves, that our teaching methods are primarily those of propaganda. We appeal—without demonstration—to evidence that supports our position. We only introduce arguments or evidence that support the currently accepted theories, and omit or gloss over any evidence to the contrary. We give short shrift to alternative theories, introducing them only in order to promptly demolish them—again by appealing to undemonstrated counter-evidence. We drop the names of famous scientists and Nobel prizewinners to show that we are solidly on the side of the scientific establishment. ... Of course, we do all this with the best of intentions and complete sincerity.” Mano Singham, “Teaching and Propaganda,” *Physics Today*, June 2000, p. 54.
3. Analytical skills in science include observing; classifying; measuring; explaining; predicting; applying mathematics; designing investigations and experiments; collecting and analyzing data; drawing conclusions; identifying assumptions; contrasting alternative explanations; formulating definitions, questions, hypotheses, and models; and retracting prior conclusions when the evidence warrants it.

What Are the Social Consequences of Belief in Evolution?

Opinions about origins have profound social consequences and even affect the way we think. Consider the following italicized perspectives and some responses. Notice that all these perspectives presume evolution occurred, despite the scientific evidence. Yes, some people believe that God used evolution to create and that evolution is compatible with the Bible; however, a careful reading shows, in dozens of ways, that it is not. [See “[Is Evolution Compatible with the Bible?](#)” on pages 537–545.]

1. **Animal-like Behavior.** *If humans descended from animals, why shouldn’t humans behave like animals?*
2. **Meaninglessness.** *If evolution happened, why believe that life has any purpose other than to reproduce and pass on your genes?*¹

Response: Evolution did not happen. Your life has purpose and hope. God does not make mistakes. You are not an accident.

3. **Good vs. Evil.** *If nature is all there is, why believe there is good and evil?*²

Response: Distinguishing good and evil requires broad, even absolute, standards—and Someone competent to set those standards. Humans instinctively know there is good and evil, right and wrong. Someone implanted that understanding in us; the laws of physics can’t.

4. **Survival of the Fittest.** *If we evolved by “survival of the fittest,” then getting rid of the unfit is desirable. To conquer and exploit weaker people, businesses, or countries is just the law of the jungle from which we evolved. Mercy killings, forced sterilization, and selective breeding of humans, while unpopular with some, would be beneficial, in the long run, and very logical—if we evolved.*
5. **Communism.** Friederich Engels, one of the founders of communism, wrote Karl Marx, another founder, and strongly recommended Charles Darwin’s book,

The Origin of Species. In response, Marx wrote Engels that Darwin's book "contains the basis in natural history for our view [communism]." ³ Marx offered to dedicate his book, *Das Capital*, to Darwin, but Darwin declined.

Joseph Stalin, ruthless dictator of the Soviet Union from 1929 to 1953, killed millions of his people. Stalin read Darwin's book as a student at a church-based school and urged others to read it. During that time, he became an atheist.

6. **Personal Responsibility.** *If everything came into existence by chance and natural processes, then we have no responsibility to some supernatural being. Religions would be a crutch for the weak-minded and superstitious. Churches would be monuments to human ignorance.*

Furthermore, if evolution happened, then we and our actions are consequences of billions of years' worth of natural events—over which we had no control. Our responsibility for our situation is relatively small. If bad things happen to us, we are primarily victims.

Response: We were created for a purpose, so we have great responsibility, and our Creator will hold us accountable. More will be expected from those who have been given more.

7. **Relativism.** *There are no absolutes, moral or otherwise (except the fact that there are absolutely no absolutes). Your belief is just as good as mine; your truth is just as good as my truth.*

Response: Obviously, the One who created the universe, life, and humans has the authority and ability to establish timeless moral absolutes—and He has.

8. **Social Darwinism.** *If life evolved, then the human mind evolved. So did products of the human mind and all social institutions: law, government, science, education, religion, language, economics, industry—civilization itself.*

Response: Technology progresses, information accumulates, and civilization often improves, but humans remain humans—with all our frailties and shortcomings.

9. **Secular Humanism.** *If the "molecules-to-monkeys-to-man" idea is correct, then man is the highest form of being. Man should be the object of greatest concern, not some fictitious Creator that man actually created.*

Response: That philosophy is called *secular humanism* (a humane, intellectual-sounding term) that claims God is irrelevant and the Bible is fiction. Secular humanism will decline as people increasingly learn the scientific flaws of evolution.

10. **New Age Movement.** *If people slowly evolved up from bacteria, then aren't we evolving toward God? Aren't we evolving a new consciousness? Aren't we evolving into a glorious New Age?*

Response: These beliefs, built on evolution, continue to spread like a cancer, even in many churches in the world. New age beliefs also will decline as the scientific errors of evolution become known.

11. **Marriage.** *If marriage is a cultural development, begun by ignorant tribes thousands of years ago, then why not change that custom, as we do other out-of-date customs? Animals don't marry; why should people? After all, we're just animals. If people are a product of natural processes, then why not do what comes naturally? What's wrong with sexual activity outside marriage as long as no one is hurt?*

Response: God instituted marriage when He created a man and a woman (Adam and Eve) and said they should become one.

12. **Racism.** *If humans evolved up from some apelike creature, then some people must have advanced higher on the evolutionary ladder than others. Some classes of people should be inherently superior to others.*

Response: But that's racism. That's the twisted logic Hitler used to try to establish his Aryan master race and to justify killing six million Jews in the Holocaust. This does not mean that evolutionists are racists (although Charles Darwin and many of his followers of a century ago were extreme racists). However, evolution has provided the main rationale for racism. Stephen Jay Gould wrote that "Biological arguments for racism ... increased by orders of magnitude following the acceptance of evolutionary theory." [See Endnote 3 on page 529.] People with darker skin have suffered greatly from evolutionary racism. Belief in evolution has also caused others to suffer. They are victims of a holocaust going on all around us—abortion.

13. **Abortion.** *We dispose of unwanted animals, such as cats and dogs. If humans are evolved animals, why not terminate an unwanted pregnancy? Isn't it the mother's right? Shouldn't she have a "choice" in such a personal matter? After all, a fetus has no name or personality. During its first three months, it's just a tiny glob of tissue—no more important than a little pig or rabbit. Why shouldn't a fetus, having less value than an adult, be "terminated" if adults or society would benefit? This will help solve our population problem. We must guide our destiny.*

Response: Abortion is the premeditated killing of an innocent, defenseless, developing (but completely human) baby. Calling an unborn child merely a "fetus" is dehumanizing. Nor should we speak of "terminating

a pregnancy.” That is simply a euphemism for killing a very young human.

Nine years after Darwin published his theory of evolution, Professor Ernst Haeckel announced that animal embryos, including unborn humans, pass through stages that mimic their evolutionary ancestors. Human embryos begin as microscopic spheres, because, Haeckel said, humans evolved from bacteria, which are sometimes microscopic spheres. Later, unborn babies look like fish, because humans evolved from fish. Still later, human embryos look like chimpanzees, because humans evolved from some apelike ancestor. So, human embryos are not yet human. Can you see the errors in this logic? *Similarity does not imply a genetic relationship.*

Haeckel faked his drawings to fit his theory. In the following 140 years, hundreds of textbook writers copied these drawings, popularizing the theory. Haeckel’s theory has since been taught as fact worldwide, even in medical schools. Today, although the theory is completely discredited, it is still taught. [See “**Embryology**” on page 11 and page 63.]

Unborn children *are* human. When you were just one cell inside your mother, all the marvelous, complex information that physically defines you and every organ in your body was there. Although you were tiny and immature, you were completely

human when you were one cell. While you were in your mother’s womb, she was your support system, just as medical support systems are needed by some sick or elderly people. Needing a support system does not remove a person from the human race or justify killing that person.

Although these matters have nothing to do with whether evolution is true or false, they have much to do with the importance of the issue and the adverse consequences of teaching that evolution is a fact. These social problems did not originate with evolution, but *they follow logically from evolution*. No doubt, most evolutionists are as opposed as creationists to many of these social problems, but from an evolutionist perspective these behaviors are easily justified, rationalized, or tolerated. Evolution, while not the cause, can usually defend or justify even immoral behavior—with seeming scientific credibility.⁴

Obviously, the creator of a complex machine can best provide its operating instructions. Likewise, only our Creator has the wisdom and authority to establish timeless moral absolutes. By what logic could anyone oppose these thirteen italicized viewpoints if there were no moral absolutes? Without moral absolutes, “right” and “wrong” will be decided by whoever is in control, and that will change from time to time. A false understanding of origins has subtle and far-reaching consequences.

References and Notes

1. “Perhaps most importantly, if the world and its creatures developed purely by material, physical forces, it could not have been designed and has no purpose or goal. ... this seems to be the message of evolution.” Douglas J. Futuyma, *Science on Trial* (New York: Pantheon Books, 1983), pp. 12–13
- ◆ “The more the universe seems comprehensible, the more it also seems pointless.” Steven Weinberg, *The First Three Minutes* (New York: Bantam Books, Inc., 1977), p. 144.
2. “The universe we observe has precisely the properties we should expect if there is, at bottom, no design, no purpose, no evil and no good, nothing but blind, pitiless indifference.” Richard Dawkins, *River out of Eden* (New York: Basic Books, Inc., 1995), p. 133.
3. Conway Zirkle, *Evolution, Marxian Biology, and the Social Scene* (Philadelphia: University of Pennsylvania Press, 1959), p. 86.
4. Some evolutionists even say that rape is a consequence of evolution. Professors Randy Thornhill and Craig T. Palmer, in their book, *A Natural History of Rape: Biological Basis of Sexual Coercion* (Cambridge, Massachusetts: The MIT Press, 2000), say that rapists, on average, have more children than other men; that is, they have greater “reproductive success.” Therefore, after millions of years, rapist tendencies have spread within the human population. “Good,” according to evolution theory, is whatever enhances “reproductive success”; “good” has nothing to do with morality. The fields of evolutionary psychology and sociobiology, taught in many universities, popularize and legitimize such ideas.

Does the New Testament Support Genesis 1–11?

Over the past century, claims that evolution is a scientific fact have become more entrenched in our schools. As a result, the first eleven chapters of Genesis have slowly become an embarrassment within many Christian churches and seminaries. Few people in these churches and

seminaries have stopped to consider just how foundational these chapters are to the New Testament. The early chapters of Genesis were frequently referred to by every New Testament writer and Jesus Christ Himself. What happens to their credibility if these early chapters are

incorrect? Listed below are 68 direct references in the New Testament that refer back to these foundational chapters of Genesis. [Based in part on Dr. Henry M. Morris' book, *The Remarkable Birth of Planet Earth* (San Diego: Institute for Creation Research, 1972), pp. 101–103.] There are many more indirect references.

All New Testament writers believed that Genesis 1–11 was historically accurate. Note:

a. Every New Testament writer refers to the early

chapters of Genesis (Genesis 1–11).

b. Jesus Christ referred to each of the first seven chapters of Genesis.

c. All New Testament books except Galatians, Philippians, I and II Thessalonians, II Timothy, Titus, Philemon, and II and III John refer to Genesis 1–11.

d. Each of the first eleven chapters of Genesis is directly referred to somewhere in the New Testament.

Table 38. New Testament References to Genesis 1–11 (*The words of Jesus Christ during His earthly ministry.)

Reference	Topic	Genesis Reference
*1. Matthew 19:4	Created male and female	1:27, 5:2
*2. Matthew 19:5–6	Cleave to his wife; become one flesh	2:24
*3. Matthew 23:35	Righteous Abel	4:4
*4. Matthew 24:37–39	Noah and the Flood	6:1–22, 7:1–24, 8:1–22
*5. Mark 10:6	Created male and female	1:27, 5:2
*6. Mark 10:7–9	Cleave to his wife, become one flesh	2:24
*7. Mark 13:19	Since the beginning of the creation which God created	1:1, 2:4
8. Luke 3:34–36	Genealogies: Abraham to Shem	10:22–25, 11:10–26
9. Luke 3:36–38	Genealogies: Noah to Adam to God	5:3–29
*10. Luke 11:51	Blood of Abel	4:8–11
*11. Luke 17:27	The flood came and destroyed them all	7:10–23
12. John 1:1–3	In the beginning God	1:1
*13. John 8:44	Father of lies	3:4–5
14. Acts 14:15	Who made the heaven and the Earth	2:1
15. Acts 17:24	God made all things	1:1–31
16. Romans 1:20	The creation of the world	1:1–31, 2:4
17. Romans 4:17	God can create out of nothing	1:1–31
18. Romans 5:12	Death entered the world by sin	2:16–17, 3:19
19. Romans 5:14–19	Death reigned from Adam	2:17
20. Romans 8:20–22	Creation corrupted	3:17–18
21. I Corinthians 6:16	Two will become one flesh	2:24
22. I Corinthians 11:3	Head of the woman	3:16
23. I Corinthians 11:7	In the image of God	1:27, 5:1
24. I Corinthians 11:8	Woman from man	2:22–23
25. I Corinthians 11:9	Woman for the man	2:18
26. I Corinthians 15:21–22	By a man came death	2:16–17, 3:19
27. I Corinthians 15:38–39	To each ... seeds of its own (kind)	1:11, 1:21, 1:24
28. I Corinthians 15:45	Adam became a living being	2:7
29. I Corinthians 15:47	Man from the earth	3:23
30. II Corinthians 4:6	Light out of darkness	1:3–5
31. II Corinthians 11:3	Serpent deceived Eve	3:1–6, 3:13
32. Ephesians 3:9	Created all things	1:1–31, 2:1–3
33. Ephesians 5:30–31	Cleave to his wife, become one flesh	2:24
34. Colossians 1:16	All things created by Him	1:1–31, 2:1–3
35. Colossians 3:10	Created in His image	1:27
36. I Timothy 2:13–14	Adam created first	2:18–23
37. I Timothy 2:14	Woman deceived	3:1–6, 3:13
38. I Timothy 4:4	Everything created by God is good	1:10–31
39. Hebrews 1:10	In the beginning God made heavens and Earth	1:1
40. Hebrews 2:7–8	All things in subjection under man	1:26–30, 9:2–3
41. Hebrews 4:3	Works were finished	2:1
42. Hebrews 4:4	Rest on the seventh day	2:2–3
43. Hebrews 4:10	Rest from His works	2:2–3
44. Hebrews 11:3	Creation of the universe	1:1
45. Hebrews 11:4	Abel offered a better sacrifice	4:3–5
46. Hebrews 11:5	Enoch taken up	5:21–24
47. Hebrews 11:7	Noah's household saved	7:1
48. Hebrews 12:24	Blood of Abel	4:10

Reference	Topic	Genesis Reference
49. James 3:9	Men in the likeness of God	1:27, 5:1
50. I Peter 3:20	Construction of the Ark, eight saved	6:14–16, 7:13–24, 8:1–19
51. II Peter 2:5	A flood upon the ungodly, eight saved	6:8–12, 7:1–24
52. II Peter 3:4–5	Earth formed out of water and by water	1:6–7
53. II Peter 3:6	The world destroyed by water	7:17–24
54. I John 3:8	Devil sinned from the beginning	3:14
55. I John 3:12	Cain slew his brother	4:8, 4:25
56. Jude 11	The way of Cain	4:8, 4:16, 4:25
57. Jude 14	Enoch, the seventh generation from Adam	5:3–24
58. Revelation 2:7	Tree of life	2:9
59. Revelation 3:14	Beginning of the creation of God	1:1–31, 2:1–4
60. Revelation 4:11	Created all things	1:1–31, 2:1–3
61. Revelation 10:6	Who created heaven . . . and the Earth	1:1, 2:1
62. Revelation 14:7	Who made the heaven and the Earth	1:1, 2:1, 2:4
63. Revelation 20:2	The serpent of old, who is the devil	3:1, 3:14
64. Revelation 21:1	First heaven and first Earth	2:1
65. Revelation 21:4	No more death, sorrow, crying or pain	3:17–19
66. Revelation 22:2	Fruit of the tree of life	3:22
67. Revelation 22:3	No more curse	3:14–19
68. Revelation 22:14	The tree of life	2:9

A remarkable parallel exists between the Ark and Jesus Christ. Both provided the only refuge from a horrible judgment. Both were perfect provisions, designed by God and freely available to sinful people. Conventional “wisdom” has doubted, even mocked, the sufficiency of each. To save others, both took a unique and terrible beating. People scoffed at the thought of water falling from the sky and needing to be saved; today, many scoff at the cross and the need to be saved. The Ark had many rooms; Christ has prepared a place with many rooms (John 14:2–3). The Ark had one door, which God closed; Christ said, “I am the door” (John 10:9); one day, God will close it as well. Genesis 8:4 says the Ark landed on the 17th day of the 7th month (in the *ancient* Hebrew calendar)—today’s 17th day of Nisan. Christ rose from the dead on the 17th day of Nisan—3 days after the Passover, which begins on the 14th day of Nisan. The Ark was made leak-proof by pitch (Hebrew: *kopher*); Christ’s blood is a “watertight” ransom (Hebrew: *kopher*) that

perfectly shields us. (*Kopher* is closely related to the Hebrew word, *kaphar*, which means “to atone” or “to cover.”)

The name “Jesus” provides another parallel to the Ark. “*And she will bear a Son; and you will call His name Jesus, for it is He who will save His people from their sins.*” (Mt 1:21) Clearly, the name Jesus means salvation and eternal safety. As with the Ark, “Outside of Jesus there is no safety, but inside Jesus there is no fear.”¹

An interesting parallel between Genesis and the New Testament involves the flood and water baptism. What was the *original* significance of water baptism? Of course, John baptized as a symbol of repentance for the forgiveness of sins, but where did he get the idea? The practice was a very ancient Jewish ritual called *mikveh*. As you look at the following table, consider whether water baptism, in addition to its Christian meaning and Christ’s command to baptize (Matthew 28:19–20), *should also remind us of the flood*. I Peter 3:20–21 also makes the connection.

Table 39. Comparison of the Flood with Water Baptism

The Flood	Water Baptism
The flood waters came from under the Earth’s crust.	Water for Jewish baptism (<i>mikveh</i>) had to be from an underground spring, in a container built into the ground, or in a building attached to the ground. ²
A sin-corrupted world was covered with water.	A sinful person who has trusted Christ for salvation is covered by water.
The Ark lifted the eight followers of God out of the water.	The believer is lifted out of the water. Jesus Christ is our Ark. [See above.]
After the flood began, it rained continually for 40 days and 40 nights.	After Jesus was baptized, he fasted continually for 40 days and 40 nights.
The Earth experienced a “new birth” as the flood waters retreated. ³	By accepting Christ, a person is born again. Christ tells His followers to baptize, although baptism does not produce salvation.
After the flood, a dove returned to Noah indicating that it was safe to go out into the world that had been destroyed.	After John baptized Jesus Christ, the spirit of God descended to Christ as a dove. Then Christ went into the wilderness.

References and Notes

1. Rabbi Jonathan Cahn, Keynote Address, Presidential Inaugural Prayer Breakfast, Washington, D.C., 21 January 2013.
2. In rabbinic literature, baptismal water (*mikveh*) was called “the womb of the world.”
3. The concept of water immersion in rabbinic literature is called “a new birth.”

How Can I Become Involved in This Issue?

People who learn about the case for creation and the adverse and far-reaching consequences of evolution frequently ask, “What can I do?” Others incorrectly feel that this is merely a scientific issue that must be left to scientists. Actually, each of you, with your unique circumstances, interests, and abilities, can help expose these evolutionary myths. Here are eight possibilities.

1. Understand the Problem. Evolutionary theories and interpretations are usually taught as facts. Teachers, textbooks, and the media frequently convey the attitude that evolution is the only scientific and intellectually respectable view of origins. Students are implicitly presented with a choice, a false dichotomy: “Are you going to hold a narrow-minded religious belief, or are you going to accept a scientific explanation?” Evolution is thus protected from competent criticism, and students are kept ignorant of its many shortcomings. Scientific data are ignored (see pages 5–107), while the accuracy and authority of the Bible are undermined. Students who were taught this way are now teachers, professors, publishers, and textbook writers. The creation movement threatens their positions, prestige, and income, so they tend to ignore the scientific evidence opposing evolution and supporting creation.

2. Words to Avoid.

- ◆ **Creationism.** Popular and frequent use of the word “creationism,” even by creationists, is unfortunate; the preferred term is “creation.” Why? Words have power. To most people, “isms” are usually bad. For example: terrorism, communism, racism, sexism, socialism, antisemitism, humanism, scientism, etc. The term “creationism,” therefore, is prejudicial. Furthermore, “isms” are belief systems or ideologies. Although creation has important belief aspects, creation is not just a belief, as evolutionists maintain, but is supported by much scientific evidence. The term “creationism” de-emphasizes this scientific evidence and carries the negative connotation of most “isms.”
- ◆ **Prove.** Science doesn’t *prove* anything (although it does build knowledge). Proofs occur only in mathematics. Furthermore, mathematical proofs are not absolutely true, since one begins with assumptions called *axioms* and *postulates*. If they change, your “proofs” change. In science, nothing is ever absolute, because not all the evidence and possible explanations have been

considered. Those who use the word “prove” in a scientific context usually are overstating something. Hardly ever will you hear an experienced scientist say that something in science has been proved. Better terms include *indicates*, *suggests*, and *supports*. In science, explanations (hypotheses and theories) are made increasingly plausible or implausible by evidence.

3. Learn More and Teach Others. Tell your friends what you have learned. Encourage them to learn more about the creation-evolution issue. Excellent books and periodicals are available—some at your local libraries and bookstores. Learn more yourself, and explain it to others in formal and informal settings. Conduct tours to nearby museums, and identify the errors in their displays. You will be surprised at how excited and grateful people become after learning this information. A growing number of people work full time giving presentations on creation. If you are an effective speaker, you may wish to consider such work. Demand for speakers greatly exceeds the supply.

Those interested in forming a group to study this book may request the *Study Guide* as a free email attachment (PDF) by writing feedback@creationscience.com.

4. Talk to Educators. Write or talk to teachers, school officials, and school-board members in your community. Ask them such questions as the following: Are you aware of the many fallacies concerning the theory of evolution that we have all been taught? Are you teaching all the scientific evidence? Are you aware that the great majority of the American public wants both evolution and creation taught? Are you aware that more than 85% of the public do not want only evolution taught?¹ Our message to educators should be:

- ◆ Teach the scientific evidence for **and against** evolution. [See pages 566–568 for responses to standard objections to doing this.]
- ◆ Teach students to think critically: to examine evidence, to test alternative hypotheses, to question, to identify hidden assumptions, to think accurately, and to reach their own conclusions.
- ◆ Teachers should become technically up-to-date and learn the evidence concerning origins.
- ◆ Teachers have a responsibility for the accuracy of what they say in their classrooms.

Many educators mistakenly believe that most scientific creationists want to legislate their views into the classroom. ***Assure teachers and professors that few, if any, scientists who are creationists advocate legislation that would force certain views to be taught.*** Even if every legislature required teachers to present both creation and evolution, unproductive hostility and ridicule would result. The scientific evidence for creation is so strong that education and persuasion are much more effective and lasting.

However, at least ten states in the United States have passed laws explicitly allowing teachers to objectively present additional scientific evidence, analysis, and critiques regarding topics already in the approved curriculum. No lawsuits have resulted. Explain to friends and educators that most creationists advocate the following:

- ◆ ***No religious doctrines or writings should be taught—or ridiculed—in science classes in public schools.***
- ◆ ***All the major scientific evidence dealing with origins should be taught at the appropriate grade levels.***
- ◆ ***When a theory of origins is presented, any reasonable opposing evidence should also be presented.***

5. Propose the Origins Research Project. Encourage science teachers and professors, as well as members of boards of education, to add an Origins Research Project to their curriculum. [See “**The Origins Research Project**” on pages 548–551.] Such a project, in which each student decides which theory of origins the scientific evidence best supports, could be one of the most interesting and maturing, projects the students ever experience. This high school or college-level project, can be tailored to fit many school or classroom situations, requires no special teacher training, favors no theory of origins, is not restricted to

just two models (creation and evolution), focuses on only scientific evidence, removes any concern about bringing religion into public schools, and involves only a moderate amount of classroom time and expense.

6. Challenge Evolutionists. Encourage knowledgeable evolutionists to enter either the simple oral/phone debate or the written debate. [See pages 570–571.] If they decline, make a point of asking, “Why won’t evolutionists debate the scientific evidence?” Do not argue with such evolutionists until you are familiar with the evidence. If you are not, refer these evolutionists to those who are.

7. Expose Theistic Evolution. Speak with pastors, priests, ministers, or rabbis. Show them that the scientific evidence is consistent with the biblical account of creation and the worldwide flood of Noah’s day. If they are not already aware of it, explain that evolutionists are reluctant to debate this issue on a scientific basis. Then, point out the many problems with theistic evolution and the subtle means by which the Bible has been falsely discredited because of evolution. [See “**Is Evolution Compatible with the Bible?**” on pages 537–545.] Encourage church leaders to add creation books and audiovisual materials to your church library and invite speakers to address this subject. Consider speaking on the subject yourself.

8. Inform the Media. Write letters to television stations and newspaper and magazine editors. Compliment them whenever they give accurate and balanced coverage of the creation-evolution issue. Provide polite and reasoned criticisms when they assume that evolution is a fact or when they avoid the scientific evidence. Inform the advertisers and media officials of the public’s positions on the issue of origins.¹

References and Notes

1. Many organizations have surveyed public attitudes on the teaching of origins. Results are remarkably consistent, regardless of whether creationist, evolutionist, or another organization conducted the survey. Typically, responses are as follows:
 - 5% I would like only evolution taught.
 - 15% I would like only creation taught.
 - 70% I would like both creation and evolution taught.
 - 10% No opinion, or teach neither.

Some incorrectly claim that almost all scientists believe in evolution. The only survey of scientists of which I am aware involved chemists. Fewer than half (48.3%) said that “it was possible that humans evolved in a continuous chain of development from simple elements in a primordial soup.” A slight majority (51.7%) said that “supernatural intervention played a role.” [Murray Saffran, “Why Scientists Shouldn’t Cast Stones,” *The Scientist*, 5 September 1988, p. 11.]

Why Do Creation Organizations Have Differences?

Differences within the creation science community are no more surprising than those between denominations or churches. Differences have been present ever since the church began. Even Peter, Paul, and James had differences. While disagreeing on some issues, they respected and

appreciated each other’s work. That is generally true for creation science organizations. The *Center for Scientific Creation* (CSC) is grateful for the many creation science ministries and speakers. Although quite distinct, each fills an important niche. This battle for minds is huge. All who help

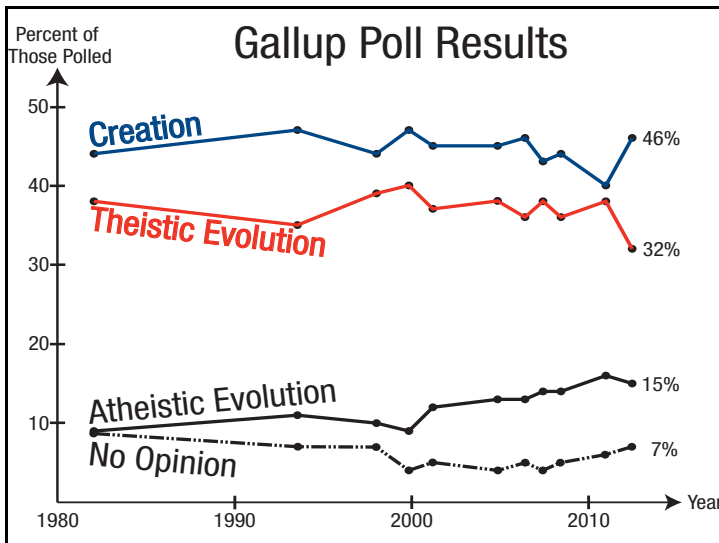

Figure 254: Gallup Polls. Eleven Gallup polls have surveyed beliefs in the United States concerning origins. People were given four choices:

- ◆ Creation: God created man in his present form at one time within the last 10,000 years.
- ◆ Theistic Evolution: Man has developed over millions of years from less-advanced forms of life, but God guided this process, including man's creation.
- ◆ Atheistic Evolution: Man has developed over millions of years from less-advanced forms of life. No God participated in this process.
- ◆ No Opinion

Notice how few people are atheistic evolutionists, yet this position dominates the media and most schools. Surprisingly, despite a century of monopolistic and required teaching of evolution, so many are creationists. Both common sense and scientific evidence reject evolution.

Sampling errors: $\pm 3\%$. Data taken from George Gallup Jr., *The Gallup Poll* (Wilmington, Delaware: Scholarly Resources Inc.).

are needed and appreciated, although we may use different approaches and have different scientific backgrounds.

Creation science organizations vary in size, finances, activities, style, views of Scripture (including which translation is best), target audiences, and methods for acquiring scientific information. Large organizations have wide forums and many opportunities to present their perspectives, but also must maintain larger staffs and facilities, so meeting payrolls is a major consideration. CSC is small, so its activities are limited, but it has the flexibility that comes with being small and independent. (CSC's Board of Directors oversees its activities.)

If fund raising is essential for an organization's survival, major resources are usually devoted to developing and maintaining a donor base, mailings, and financial appeals. If donors become the primary audience, organizations may end up "preaching to the choir," and newsletters may emphasize why their organization is deserving. As a not-for-profit organization, CSC is grateful for donations, although we never solicit them. Instead, our focus is on research, writing, and helping those teaching the subject. The sales of our book, *In the Beginning: Compelling Evidence for Creation and the flood*, support most of CSC's work.

Creation science groups also have different target audiences. Most creation groups primarily address church audiences and emphasize biblical aspects of origins. Some groups focus on specific denominations or local regions. CSC's target audience is universal—Christians and non-Christians, scientists and laymen, and evolutionists and creationists.

Creation organizations acquire scientific information in various ways, but *almost all rely on people they trust or something they have read*. However, I believe primary sources of information must always be sought, directly examined, and tested. Frequently, I conduct my own experiments, computer simulations, calculations, and field trips. My reading load is large and includes the most

authoritative science journals and books, often resulting in communication with authors of relevant papers. When our mutual interest is a scientific matter, I am not concerned with an author's philosophical positions—and rarely does it arise in our cordial discussions or correspondence. Some creationists feel differently and prefer not to interact with an evolutionist, atheist, someone with a different doctrinal position, or fellow creationists who are independent.

Most creationists focus on one or a few scientific disciplines, such as the life sciences. However, people's questions have no academic boundaries, and multiple disciplines often bear on an issue, so I try to study in depth all scientific disciplines relating to origins. I have always had to work in multiple scientific disciplines: in diverse engineering situations at MIT, as a professor preparing thousands of students for practically all technical fields, and as the director of a large research and development laboratory. One of the most frequent and longest standing criticisms of me by the *Institute for Creation Research* (ICR) and *Answers in Genesis* (AiG) is that I am not a degreed geologist. That is true, although I have studied much geology and have worked with great geologists. Had I studied only geology, I might have accepted some evolutionary assumptions. Furthermore, I would not have had the in-depth study in physics, mathematics, mechanics, materials science, and other disciplines that are so important to a scientifically sound understanding of the flood. Thus, Part II of this book, which examines the flood, would not exist.

A newer movement, *Intelligent Design* (ID), vigorously and effectively defends the scientific evidence supporting the creation of life. The ID movement restricts its scientific case primarily to the life sciences, using almost identical evidence and arguments long used by creationists. (See categories of evidence 1–42 on pages 5–25.) That body of evidence is the easiest to understand for laymen and those who are already creationists. However, because the ID movement rejects the global flood and supports the big

bang and an old Earth, and rarely deals with geology, physics,¹ and major topics in astronomy, ID uses only a portion of our available tools. (Understanding the global flood is critical in dismantling evolution. Conversely, those not accepting the flood, as explained in Part II of this book, will probably believe in evolution or a multibillion-year-old Earth—or both.) Even outside the classroom, most ID leaders avoid publicly discussing the Bible or identifying the “intelligent designer” as the Creator,² but when seeking funds, they court the Christian community.³ By avoiding the more complex, controversial, and to some, embarrassing matters mentioned above, the leaders of ID believe they will appeal to some in the academic community—their target audience. While I agree that *biblical* matters should not be brought into public schools, science courses should not ignore relevant *scientific* evidence.

Questions frequently arise about Dr. Hugh Ross and his organization, *Reasons to Believe*. CSC disagrees with many of Ross’ scientific and biblical positions, especially his claims that the big bang (a flawed theory⁴) was the creation event, Noah’s flood was not global but only a local flood, and hominids existed 2–4-million years before Adam. Some have tried to arrange for written or oral debates between Dr. Ross and myself. I accepted; he declined.⁵

Two of the largest creation organizations are ICR and AiG. ICR’s approach is more academic; AiG’s is generally directed to Christian lay people. Both organizations hold the Bible in the highest regard, see creation as a foundational issue, and defend a global flood and a young Earth and universe. CSC agrees and is grateful for ICR’s and AiG’s strong positions in these areas. However, CSC and ICR/AiG have had serious differences.⁶

Misleading Statements

For many years, AiG and a few at ICR have made frequent and inaccurate comments concerning CSC’s book, *In the Beginning: Compelling Evidence for Creation and the Flood*. Several differences include:

- ◆ How much dust and regolith should be on a 4,600,000,000-year-old moon?⁷
- ◆ Is *Archaeopteryx* a bird or a fraud?
- ◆ What froze the mammoths?^{8,9}

ICR’s Canopy Theory. Our biggest difference (largely hidden from the public for 30 years) is, “**What flood explanation best corresponds to science and the Bible?**” I proposed the hydroplate theory (HPT) in 1972, two years after ICR began. For several decades afterward, ICR taught millions of people what is now recognized by almost all creation researchers (including ICR) as the scientifically and biblically flawed canopy theory. It was first proposed by atheist Isaac Newton Vail in 1874, but adopted, without credit, and promoted, by Henry M. Morris, Jr. and John Whitcomb in 1961 in their otherwise

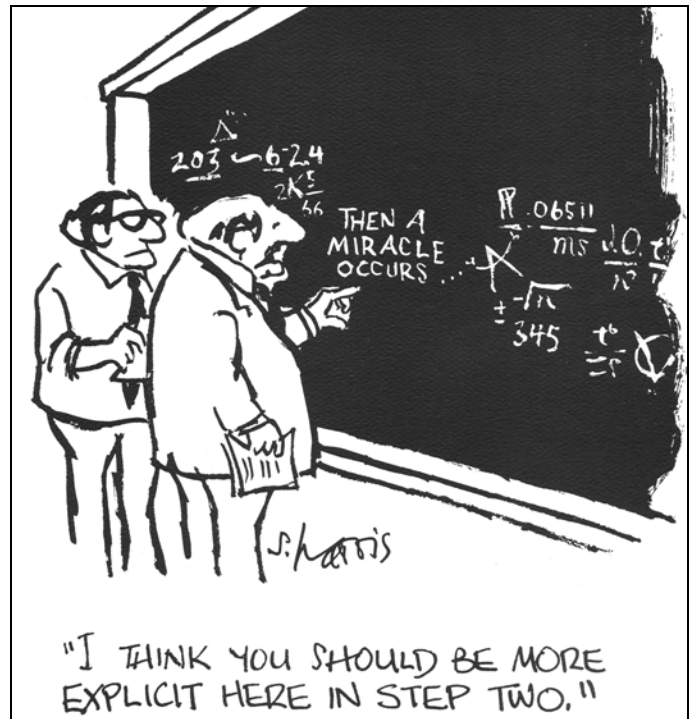

Figure 255: Convenient Miracles. Although the Bible speaks of specific miracles, that does not give us license to invoke other miracles to solve our scientific problems. That would violate the most basic rule of science, which is:

Scientific conclusions must be based on evidence and the laws of physics—not imagined miracles.

Evolutionists love to accuse creationists of violating this rule—a common practice in past centuries that produced hostility by many scientists to the Bible. Some of that hostility still exists. Fortunately only a few creationists invoke miracles today to solve their scientific problems.¹¹

Almost any model or explanation for the flood (or anything else) could be patched together if its author, when confronted with a scientific problem, could simply claim that a miracle must have occurred. Of course, science would be in shambles if invoking self-serving miracles not mentioned in the Bible were allowed. *Evolution requires many miracles.* [See pages 5–107.]

important book, *The Genesis Flood*.¹⁰ [For a discussion of these problems, see “**Did a Water Canopy Surround Earth and Contribute to the Flood?**” on pages 518–526.]

In the 200 full-day seminars I held in the United States and Canada between 1981 and 1999, a frequent question in the hour-long question-and-answer period was my view of the canopy theory. I tried to answer each question briefly and factually (based on science and the Bible), without criticizing anyone. Nevertheless, my answers visibly shocked many in the audience. After only a year, a clearly displeased Henry Morris asked me to set up my own organization and no longer be associated with ICR.

ICR’s Catastrophic Plate Tectonics (CPT). In 1998, ICR quietly acknowledged many fatal problems with the canopy theory and began advocating CPT, a variation of the evolution-based plate tectonic theory, but sped up a trillion

times by assumed miracles not mentioned in the Bible. *Miracles not mentioned in the Bible should not be claimed to solve scientific problems.* That practice by some creationists in past centuries resulted in much of the scientific world's hostility toward creationists. The media and many evolutionists still believe that is how creationists do science.

Both plate tectonics (taught in almost all geology courses worldwide) and CPT are seriously flawed, biblically and scientifically. [See for example, “[Does Recently Declassified Data Falsify Plate Tectonic Theory?](#)” on page 500.] Nevertheless, since quietly abandoning the canopy theory, ICR has advocated their CPT and fueled opposition to the hydroplate theory. Other organizations have followed ICR's lead: Answers in Genesis (AiG), Creation Ministries International (CMI) in Australia, and the Creation Research Society (CRS). These four organizations show little understanding of the science and are unwilling to debate the issue in an open forum: Plagiarism within ICR has also contributed to the tension. [See “[The Plagiarism Controversy](#)” on page 246, and Endnote 1 on page 524.]

Bob Enyart, pastor of Denver Bible Church and a cohost of the radio program, *Real Science Radio*, has had a long and friendly relationship with all creation organizations. He learned of this conflict on his own and studied it thoroughly. He surprised me by bringing it out in the open in 2015 in a popular 3-hour DVD and Blue Ray production, “*The Global Flood and the Hydroplate Theory*,” which can be purchased at rsr.org

A much abbreviated YouTube version of his program is at <https://www.youtube.com/watch?v=aGwaTF9l298>

Perhaps the easiest way to understand this controversy is to listen to a 3-part radio interview between Pastor Enyart and engineer Jane Albright, who also thoroughly studied the controversy, but in a much different way—by direct, transcribed interviews with and questioning of all parties, followed by a series of four articles laying out her findings and recommendations. Both the radio interviews and articles can be found at

<http://kgov.s3.amazonaws.com/bel/2016/20160722-BEL146.mp3>

Her four articles are also posted at

calvarypo.org/noahs-flood-the-bible-the-science-the-controversy/

Albright made every effort to be thorough, fair, accurate, and independent. Her cordial, but detailed and transcribed interviews brought out, exposed, and squashed rumors and false gossip that had been swirling behind the scene for the past 30 years. She will provide others who wish to independently study this controversy with the names, organizational affiliations, contact information, and relevant documents of the 33 people she tried to interview. (About half refused.) Almost none of those interviewed had read the hydroplate theory. Albright gave all the opportunity to

express their disagreements to me directly in a conference call or in a publicly available debate—oral or written. Everyone declined. [See pages 570–571.]

All were also given the opportunity to amend anything in her transcription of their interviews and to correct any error in her four articles. A leader of one of the above organizations complained that Albright was airing a lot of dirty laundry. After explaining past efforts to correct these problems and the harm this gossip and slander had done to the creation movement, she wrote back to him that “Alas, there is a time for ‘taking it to the church.’ I don’t see any examples in Scripture where God asks us to conceal sin.”

AiG and ICR have also distributed standardized letters containing incorrect information about CSC's book. Informal misinformation continues, as do repercussions from past statements.¹² While I welcome criticisms of my research, I do object to uninformed, false statements.¹³ Those who interact with these objectors soon learn that they have not read what they criticize.¹⁴ I have offered to debate all these issues orally or in writing in any fair and open forum. AiG has formally declined, saying that they are not scientifically qualified. A few at ICR have also sent letters declining.

AiG, as a counter to this offer, invited me to submit an article to their *Technical Journal (TJ)* which they proudly describe as a peer-reviewed journal. That simply means that AiG's associates (so-called peers) pass judgment on what is submitted and make recommendations to AiG's editor. Although AiG's history of false comments would make anyone in my position cautious of their offer, other factors make it even less desirable.¹⁵

- a. Concerning the flood, I would need to summarize 380 pages of evidence and explanations in a relatively short article, leaving much out and leaving readers with many honest questions. This effort would produce an incomplete paper in contrast to the full explanation, which reaches far more people, is already in my book, and can be read at no cost at www.creationscience.com. (In fact, at this time, googling on {creation evolution flood} consistently ranks our website as the most popular out of more than 564,000 web pages containing those words.)
- b. The other scientific differences “bulleted” above, while smaller in scope, also relate to the flood in various ways. To address those topics requires first understanding the flood events.
- c. Written efforts by others in favor of the hydroplate theory have been rejected by *TJ*.
- d. Because of personal inclination and to conserve time, I never press my views on others (including other creation groups) or initiate such attempts. I simply make my case available, continue my research, try to improve this book's accuracy and clarity, respond to questions and criticisms from those who have read what I have written, and *gladly enter, as time permits, wide*

forums where ideas can be directly contrasted. (My staff consists of a part-time secretary.) I try to explain to those interested—whether they agree or disagree—not persuade those who are not interested or will not read.

For the past 30 years, some at AiG, ICR, and a few people close to those organizations have criticized the hydroplate theory by saying that it has not been “peer reviewed.” Actually, I would like it to be peer reviewed, provided:

- a. The reviewers claim to be neutral, are named, and have read the latest version of the hydroplate theory.
- b. I am allowed equal space to respond to the reviewer.
- c. Our respective comments are open to the public.

A similar offer is on page 571. So far, no one has accepted.

As for peer review, a glance at the endnotes in this book will show that my work draws from about a thousand peer-reviewed papers in the most respected scientific journals. Those papers usually document what are anomalies for evolutionists, but are explained by *the hydroplate theory*.

What these critics probably mean is that they want the 380-page hydroplate theory reduced to a 3–6 page article that they *might* publish, or label as faulty. However, the hydroplate theory can’t be easily condensed. It involves many disciplines and deals with such diverse topics as the origin of the Grand Canyon, the ice age, earthquakes, ocean basins, the inner and outer cores of Earth, frozen mammoths, comets, asteroids, trans-Neptunian objects, and Earth’s radioactivity. Most of the hydroplate theory’s 25 major subtopics provide evidence for the other subtopics, so an incomplete explanation would leave out much supporting evidence and raise hundreds of reasonable questions. Besides, true preview journals do not accept previously published material, which eliminates almost all of what I would submit.

In September 2003, the *Creation Research Society Quarterly* (CRSQ), which claims to be a peer-review journal, did publish my then unpublished article, “What Triggered the Flood?” See pages 469–475.) I found the CRSQ’s peer-review process shallow at best. By claiming to be a peer-review journal, the CRSQ can impress novices by claiming to be in the same league as hundreds of true peer-review journals.

Nevertheless, AiG/ICR and I are probably best able to critique each other’s views of the flood, so why don’t we begin? The principle is simple: *If one advocates a position before an audience, he should be willing to defend it before that audience.* Such an exchange—cordial and complete—would benefit all, especially creationists.

However, I have sadly come to feel that ICR and AiG do not want their ideas concerning the flood tested by a

thorough public contrast with the hydroplate theory. Both groups depend on donations and may be trying to maintain, among donors and followers, an image of scientific accuracy and leadership.

Teaching indefensible theories—including the canopy theory—has misled many. Decades of harm, unrepaired by ICR and AiG, have resulted. They taught the canopy theory to millions, who, in turn, have advocated it to tens of millions. It is now rooted in many churches worldwide. Who should clean up that misinformation, now that almost all researchers know it is wrong?

Frequently, people write, call, and email, seeking my reaction to criticisms from these four organizations, but I don’t have time to respond to each individual. If I tried, I would become a full-time “firefighter,” never able to complete scientific studies and other projects. However, my offer to debate all scientific disagreements with them stands. If enough pages were allocated and a neutral editor selected, the full exchange could be published in an independent journal, perhaps the *Creation Research Society Quarterly*, or even in technical journals published by AiG or Creation Ministries International (CMI). Others will need to encourage ICR, AiG, CMI, and CRS to participate.

How to Become More Unified

If these problems were “swept under the rug,” hopes for solving them would diminish. (The Bible sets an example by not hiding the mistakes of such figures as Abraham, Jacob, David, Solomon, Peter, and many Hebrew kings.) Two issues contribute to these differences among creationists. First, no unbiased, open forum exists in which inevitable differences (large and small, scientific and nonscientific) can be thoroughly, systematically, and fairly contrasted and made public. If fairly executed, this should be a function of the CRS. The second problem, which we all must guard against, can be described in many ways: organizational pride, empire building, or belief that one’s organization best speaks for the creation community, deserves donations, or should be the clearing house for creation information. Solving the first problem (establishing an independent forum) could minimize the second.

Hopefully, others will address these matters. I suspect the internet will play a big role. Although we can always expect some differences, greater harmony and cooperation are needed—and possible. While our scientific abilities, sizes, styles, finances, activities, and target audiences differ, our target—evolution—does not.

References and Notes

1. Phillip E. Johnson, the main architect of the intelligent design (ID) movement, calls this “the wedge strategy.” [See his excellent book, *The Wedge of Truth: Splitting the Foundations of Naturalism* (Downers Grove, Illinois: InterVarsity Press, 2000).] In 2001, Phillip Johnson made clear to me in a cordial, private conversation that he felt the flood should not be discussed; it was too complicated. I disagreed.
2. “Stick with the most important thing—the mechanism and the building up of information [in living things]. *Get the Bible and the Book of Genesis out of the debate, because you do not want to raise the so-called Bible-science dichotomy.*” Phillip E. Johnson, as quoted in “Berkeley’s Radical,” *The Wayback Machine*, 4 June 2002, p. 5.
3. “We also seek to build up a popular base of [financial] support among our natural constituency, namely, Christians.” Phillip E. Johnson et al., “The Wedge,” July/August 1999 at: www.antievolution.org/features/wedge.pdf
4. See “Big Bang?” on page 32 and “Why Is the Universe Expanding?” on page 439.
5. Ross once admitted to me that he knew he had some biblical problems.
6. One issue is plagiarism. For one example, see page 246. Those who read that two-page sidebar and request all the backup correspondence will see other examples. ICR’s leaders were given the opportunity to point out (and have removed) any errors before it was published. None were given.

Some plagiarized material is featured in AiG’s museum and in their DVD, *Flood Geology*. Others have notified AiG’s leaders of the problems, but are simply told to see AiG’s lawyers.

Why is this a problem? Those who want to know more need to be able to find the primary source to learn how solutions were reached, their limitations, alternate solutions, and who to contact if further research is planned. A lesser concern is that individuals who first read unreferenced material and later read the same material from its true originator, may think the originator plagiarized.
7. In 1993, AiG and ICR announced, much to the delight of evolutionists, that the thickness of the “moon dust” was consistent with the evolutionist age for the moon—4,500,000,000 years.

Calculations show that the amount of meteoritic dust in the surface dust layer [of the moon], and that which trace-element analyses have shown to be in the regolith, is consistent with the current meteoritic dust influx rate operating over the evolutionists’ time scale. Andrew A. Snelling (AiG) and David E. Rush (ICR), “Moon Dust and the Age of the Solar System,” *Technical Journal*, Vol. 7, Part 1, September–November 1993, p. 39.

Of course, AiG and ICR do not believe the moon is 4.5-billion years old, but from 1993–2015 they forcefully told creationists not to use the “moon-dust argument,” because measurements support the evolutionists’ position. I am convinced that a correct analysis shows that the moon is young. ICR and AiG made four major mistakes in their unnecessarily lengthy paper about moon-dust. They are listed on page 585. The data ICR and AiG used and the calculations they made were correct but incomplete.

One reason AiG and ICR told creationists not to use the “moon-dust argument” was because they believed it was based on erroneous experimental techniques of Hans Pettersson. Pettersson’s results, which I have always known were faulty and have never used, was popularized among creationists by ICR. [See Henry M. Morris, *Scientific Creationism*, General Edition (San Diego, California: Creation-Life Publishers, 1974), pp. 151–152.]

On their own initiative, many people have told AiG (and ICR) of their likely errors concerning “moon-dust” and encouraged them to read the brief, but complete, explanation on pages 583–585. AiG’s response is that I must submit an article to their magazine’s editor. Having an honest technical disagreement is one thing; adamantly ignoring the evidence and calculations while telling hundreds of thousands what they should do and believe is quite another.

8. Michael Oard, a frequent writer for ICR and AiG, provides ICR’s and AiG’s position on the frozen mammoths. Oard’s views are analyzed and contrasted with the hydroplate theory on pages 267–299. After sending my critique to Oard in 2006, I offered to respond in writing to any comments or disagreements he would send me, but none were sent.
9. Michael Oard has also proposed that the Grand Canyon formed as the flood waters drained from the earth. On 1 February 2006, he wrote and asked me to show him the evidence that supports my explanation for the Grand Canyon (since published on pages 215–257). I was confident that he would not be able to find some of the remote locations to see the evidence for himself. Nor would I be present to answer the objections Oard had been raising publicly.

So I offered to take him to the actual locations if a mutual friend of ours (senior geologist, Brent Carter) would organize a group of at least seven geologists to accompany us. Each geologist was to read beforehand the hydroplate theory and Oard’s theory. On the field trip, Oard and I would each take three days to show the group our evidence.

Both Oard and our friend agreed, and the group of seven geologists was formed. We met at the Grand Canyon on 17 July 2006. For the first three days, I took the group to many of the formations shown on pages 215–257. The fourth day, when it was Oard’s turn to show us the three-days of evidence he promised, he announced he had none to show us. Unfortunately, our group then adjourned three days early.

Instead of evidence, what Oard has published many times is a story, but nothing that can be physically examined, tested, and compared with alternate explanations. That is not science.

10. Indeed, the canopy theory is an example of using others' material without giving the source. Evolutionist Isaac Newton Vail published that theory between 1874 and 1902 in dozens of papers and a book. Later, in 1961, *The Genesis Flood*, by John C. Whitcomb, Jr. and Henry M. Morris, popularized the canopy theory. The authors made a few changes to Vail's canopy theory and put a biblical interpretation on it, but Vail's name and initial contribution were never acknowledged in any way.

Despite Henry Morris' advocacy of the canopy theory until his death in 2006 and his opposition for most of his life to the idea that the continents moved, he had a remarkable understanding of the Bible and its description of the flood. [See Endnote 10 on page 492.]

11. ICR and AiG sometimes invoke miracles to solve their scientific problems. For example, their explanation for the flood is catastrophic plate tectonics (CPT), developed by John R. Baumgardner with help from coauthors Steve A. Austin, D. Russell Humphreys, Andrew Snelling, Kurt Wise, and Larry Vardiman. Baumgardner acknowledges his miracles:

Finally, it seem (sic) evident that the Flood catastrophe cannot be understood or modeled in terms of time-invariant laws of nature. Intervention by God in the natural order during and after the catastrophe appears to be a logical necessity. Manifestations of the intervention appear to include an enhanced rate of nuclear decay during the event [Required Miracle #1] and a loss of thermal energy afterward [Required Miracle #2]. John R. Baumgardner, "Numerical Simulation of the Large-Scale Tectonic Changes Accompanying the Flood," *Proceedings of the First International Conference on Creationism*, Vol. 2 (Pittsburgh, Pennsylvania: Creation Science Fellowship, Inc., 1986), p. 24.

...the physical laws were somehow altered by God to cause the [flood] catastrophe to unfold within the time frame of the Biblical record. John R. Baumgardner, "The Imperative of Non-Stationary Natural Law [Miracles] in Relation to Noah's Flood," *Creation Research Society Quarterly*, Vol. 27, December 1990, p. 98.

One of Baumgardner's specific difficulties is explaining why his crustal plates suddenly dove into the mantle as the flood began. He explains:

An initial temperature perturbation is required to initiate motions within the spherical shell domain that represents the earth's mantle. For this, a temperature perturbation of -400 K to a depth of a few hundred kilometers is introduced around most of the perimeter of the supercontinent. John R. Baumgardner, "A Constructive Quest for Truth," *Technical Journal*, Vol. 16, No. 1, 2002, p. 80.

Why does Baumgardner "introduce" a sudden temperature drop in the top "few hundred kilometers" of the Earth, along what are now 15,000 miles of *unconnected* ocean trenches? If so much rock (10-million cubic miles) suddenly became 720°F (400 K) colder, the rock's density would increase, so much it might fracture the Earth's crust globally, forming plates (Required Miracle #3). Then, the edges of some plates might be so dense they would sink into the mantle (Required Miracle #4) just as a rock sinks into water. If so, subduction might begin. But just to be sure, Baumgardner assumes the mantle was much less viscous than today (Required Miracle #5).

It is proposed that the mantle's viscosity at [the time of the flood] was lower than at present to permit rapid sinking of the lithosphere into the mantle ... John R. Baumgardner, "3-D Finite Element Simulation of the Global Tectonic Changes Accompanying Noah's Flood," *Proceedings of the Second International Conference on Creationism* (Pittsburgh, Pennsylvania: Creation Science Fellowship, Inc., 1990), p. 35.

He then claims this is how the global flood began, but that is incorrect. The Bible says the flood began on the "day all the fountains of the great deep burst open" (Genesis 7:11). Catastrophic Plate Tectonics would not produce "fountains of the great deep" any more than a very large and hot volcanic eruption on an ocean floor would produce a jet of water shooting up from the ocean's surface. [See the statement by Henry M. Morris in Endnote 10 on page 492.]

Required Miracle #6: Temperatures cannot drop below absolute zero (-460°F), so it is impossible for anything colder than a blazing hot 260°F to drop 720°F! (260 - 720 = -460) This is not, as the title of Baumgardner's paper ironically claims, "a constructive quest for truth."

Baumgardner admits that miraculously freezing and sinking so much rock creates another problem. As cold rock sinks, hot rock deep in the Earth must simultaneously circulate up to the Earth's surface. The heat is so great that it would take millions of years for just half of that heat to radiate from the Earth. Therefore, he needs Required Miracle #7: God must have removed that heat—quickly. Why? Because the global flood happened, and the Earth's surface today is not extremely hot. If the heat wasn't removed quickly, the Earth would have experienced a runaway greenhouse effect and life on Earth would cease forever. [See "Runaway Greenhouse Effect" on page 609.]

Once the flood begins, Baumgardner must invoke Miracle #8 to produce the blanket of sediments that is spread over the continents to an average depth of 2,000 meters (1.2 miles). Those sediments must be deposited rapidly during the flood to trap and bury the plants and animals we see in the fossil record. How does he explain that? He imagines there was a moon-size body orbiting so close to Earth that tides 2,500 meters (1.6 miles) high were produced in a few days. Those tides eroded the needed sediments. This dramatic miracle is repeated six times!

Baumgardner’s “supertides” lasted 150 days. Turbulent, cavitating, high-velocity water averaged 45 miles per hour! Why weren’t all plants, animals, and the Ark pulverized? Where is that moon-size body today? No answers were given. (Miracles 9 and 10 might be needed to answer those questions.) [See John R. Baumgardner, “Explaining the Continental Fossil-Bearing Sediment Record in Terms of the Genesis Flood,” *Proceedings of the Seventh International Conference on Creationism* (Pittsburgh, Pennsylvania: Creation Science Fellowship, Inc., 2013).]

Without retracting the above explanation, but realizing its many problems, Baumgardner proposed another explanation. His subducting plate doesn’t dive smoothly or rapidly. It dives with jerks. Each jerk produces a catastrophic tsunami that erodes and distributes worldwide the mile-thick layer of sediments he needs. [See John R. Baumgardner, “Numerical Modeling of the Large-Scale Erosion, Sediment Transport, and Deposition Processes of the Genesis Flood,” *Answers Research Journal*, Vol. 9, 24 February, 2016, pp. 1–24.]

With just a little thought, it should be clear that Earth’s vast volume of sediments had to be eroded by subsurface erosion, not merely surface erosion. [See item 11 on page 201.]

Catastrophic plate tectonics requires other miracles. The hydroplate theory requires no convenient miracle (a miracle not mentioned in the Bible but claimed to solve a scientific problem). The flood and its many consequences follow from the laws of physics and three starting assumptions, for which there is clear biblical support. [See page 124.]

Another example of invoking a miracle to solve a scientific problem occurred in ICR’s **RATE** Project (**R**adioisotopes and the **A**ge of **T**he **E**arth). After spending 1.5 million donated dollars over 8 years, the long-awaited RATE study claimed that God must have removed an unbelievable amount of heat; otherwise, all oceans would have evaporated. [See “**Understanding Accelerated Decay**” on page 600, and Larry Vardiman et al., *Radioisotopes and the Age of the Earth*, (El Cajon, California: Institute for Creation Research, 2005), pp. 761–763.] “**The Origin of Earth’s Radioactivity**” on pages 378–433 answers these questions without claiming self-serving miracles.

12. For many details by an organization independent of CSC, see <http://www.calvarypo.org/HANDS/flood1.pdf>.
13. Lengthy, private correspondence, asking for this to stop has been unsuccessful. This has hurt the creation-science movement much more than it has damaged CSC.
14. The writer of ICR’s latest standardized letter criticizing the hydroplate theory later admitted that he had not read the theory. Requests for the calculations, which he claimed falsified the hydroplate theory, have been ignored. My corresponding calculations support the theory.
 - ◆ A pastor, seeing AiG’s hostility toward CSC, flew to talk with AiG’s leader, Ken Ham, directly. The pastor wrote the following:

I wanted to appeal to Ken to at least read Walt’s book. I gave him a copy of “In the Beginning.” In our meeting, Ken was hostile and arrogant toward Walt personally and toward the hydroplate theory. Ken didn’t provide any technical arguments and admitted that he had never read Walt’s theory. I left the material with Ken and encouraged him to read it with an open mind.

The following May (2000), Ken was a guest speaker at our pastors’ conference. Following his presentation, I asked him if he had read the materials I gave him the previous September. He said he had not. What was shocking to me was he still refused to read Walt’s book, even though the hydroplate theory is the only flood theory which explains many aspects of the flood and answers the questions of where the water came from and where it went.

I contacted other prominent AiG and ICR detractors of Walt’s theory trying to learn their technical reasons for disagreement. Not one responded with any kind of technical argument, written or oral. What continued to shock me, was that none had read the book. One detractor, Russ Humphreys of ICR, agreed to make a technical response if I would send him a free copy of the book. I sent the book. Six weeks later, he told me that he still had not read the book, did not intend to, and would not make any kind of technical response, since he knew the catastrophic plate tectonic theory was correct and therefore the hydroplate theory had to be wrong.

... The Biblically and scientifically sound hydroplate theory could be a “silver bullet” in the wicked heart of the evolution lie.

- ◆ A faithful financial supporter of AiG, sent a detailed letter to AiG pointing out errors in a recent series of letters AiG published (*Technical Journal*, Vol. 16, No. 3, 2002, pp. 69–73). He wrote:

I believe each man is entitled to disagree with Brown’s model. However, written misrepresentation of that model is another issue altogether. ... I suggest that someone at TJ [The Technical Journal] read and study Brown’s work before allowing this blatant misrepresentation to happen again. Shame on the editors for letting this type of poor work get out. ... You folks are making it mighty difficult for [my wife and me] to come up with reasons to support poorly written work. I suggest you get some of these things ironed out soon. As for Michael Oard and John Baumgardner, I suggest they read/reread Brown’s latest edition or better yet, give him a call.
 - ◆ For years, others have sent similar, unsolicited reports.
15. From its website, AiG has said in blunt terms that I should submit an article and “play by the rules”—meaning “their rules.”

How Harmful Is False Scientific Information?

Surprisingly, in a recent case, the court said it was a crime.

At 3:32 A.M. on 6 April 2009, a magnitude 6.3 earthquake struck the town of L'Aquila, Italy, killing 309 people, injuring 1500 people, temporarily displacing 65,000, and destroying 20,000 buildings. Days before, experts on Italy's Major Risk Commission had reassured the town's citizens that the past 4 months of frightening earth tremors indicated that stresses beneath the town were being harmlessly released—"a good thing," they said. The experts also claimed that future tremors would be no stronger than those already felt. The four scientists, two engineers, and one governmental official who provided the incorrect analysis and false reassurances of seismic risk were *each* put on trial, convicted of manslaughter, fined 1.5 million dollars (1.1 million Euros), and sentenced to 6 years in prison.¹ On appeal 2 years later, five of the six convictions were overturned.

After the initial sentence, most scientists following this case were outraged that scientists were punished for simply giving advice. An editorial in *Nature* stated, "*The verdict is perverse and the sentence is ludicrous.*"² Five-thousand scientists from dozens of countries signed an open letter to the President of Italy, calling the charges "unfounded," because earthquakes cannot be reliably predicted, and scientists will be less likely to give policy makers technical advice if punishment could result. Does this verdict set a dangerous precedence? Is science on trial?



Figure 256: Obama and World Leaders at the Crime Scene, L'Aquila, Italy.

We all make mistakes, but when those holding positions of trust make mistakes, misinform, are not scientifically up-to-date, or don't acknowledge their uncertainties, consequences may follow. The principle is simple: *With authority comes responsibility.* Officials should be as concerned about doing their jobs correctly as about expecting respect from others. This applies to political

leaders, military leaders, and teachers—including those teaching false information on the creation-evolution issue.

Providing false or superficial information on the creation-evolution issue does not *suddenly* kill people, but if you read "**What Are the Social Consequences of Belief in Evolution?**" on pages 551–553, you will see that millions of lives have been lost as a result of evolution and many more have been adversely affected. No law exists against providing such misinformation, but that does not make it or negligence acceptable. In fact, most people would agree that providing misinformation, especially to young minds, is deplorable—even if it is only due to a sloppy examination of the evidence or "following the party line." But most people providing this misinformation truly believe it, so isn't ignorance of the facts an excuse? Not if the misinformers use his or her scientific status as a reason for others to believe the misinformation. So the issue becomes, "Who is propagating poor science, and what can be done about it?"

A common military tactic is "*search and destroy.*" Infantry troops are used to *search* for and locate the opposition. Then, powerful and appropriate weapons, such as gunships, artillery, or bombers are called in. A peaceful variation of this tactic, can be used to combat false ideas about evolution. If you know an outspoken evolutionist who uses his or her position to convince others that evolution is correct and creation and the global flood never happened, you can perform the "search" function. Others will do the rest. Here's how it will work.

If you carefully study the scientific case for creation and the flood, as explained in this book, and present some of this case to the evolutionist, you can call our office at 602-956-6880. We will mail you at no cost the latest draft of the next edition of this book (in a PDF format on a CD-ROM). You may duplicate it as often as you like for friends and the evolutionist. Urge the evolutionist to participate in one of the two debate offers described on pages 570–571. The first offer (a written exchange) deals with creation, and the second (an oral debate) deals with the flood. Notice, *religion is not allowed in either exchange—only science.* We will inform you of all communications we have with the evolutionist.

Media outlets (television, radio, print) that present evolution (or any of its many tenants) as a fact, based on some authority, should urge their "expert" to participate in either debate. Most media outlets strive to avoid misinformation, so they may start to question the competence of their "experts," especially those who decline a strictly scientific debate.

Scientific incompetence, whether by an Italian risk commission or by teachers and professors—even if unintentional—can have serious consequences. Ignoring the incompetence only perpetuates it. Will you search?

References and Notes

1. Stephen S. Hall, "At Fault?" *Nature*, Vol. 477, 15 September 2011, pp. 264-269.
- ◆ Edwin Cartledge, "Aftershocks in the Courtroom," *Science*, Vol. 338, 12 October 2012, pp. 184-188.
2. *"The verdict is perverse and the sentence ludicrous. ... all efforts should be channeled into protest, both at the severity of*

the sentence and at scientists being criminalized for the way their opinions were communicated." "Shock and Law," *Nature*, Vol. 490, 25 October 2012, p. 446.

President Obama's tour through LAquila, Italy, can be seen at <http://www.youtube.com/watch?v=6QwCGPNoRIE>.

How Do You Respond to Common Claims of Evolutionists?

1. "I disagree with your work, Dr. Brown."

Response: My response to criticisms from evolutionists (and a few creationists) is consistent and straight forward. I am happy to address any disagreement, provided the critic (a) has read what I have written that relates to the criticism, (b) will engage in a direct, respectful, and balanced exchange, and (c) will allow it to be made public—both written and oral components. Usually the critic objects to all three criteria. Three formats for our exchange, which should cover most situations, are listed on pages 570–571, and 561.

It is likely that a critic you might hear has already declined such an offer from me; if not, you may make that offer in my name. Furthermore, if you ever hear someone say that he has tried to engage me on the points of his disagreement, ask to see our correspondence, especially his response to (a)–(c) above. You will probably receive nothing, but if you do, please contact me. The goal is to have a direct exchange between the critic and me.

Also, if you hear any first- or second-hand criticism, simply ask "Have you read what Brown has written?" The answer will probably be "No." If the response is "Yes," then please call our office (602-956-6880) with that person also on the line, ask to speak with me, and mention this request. Alternatively, invite the critic (or those who repeat their claims) to accept any of the three formats referenced above.

When mistakes are made, criticism is helpful; it allows me to correct what I have written. In each of my twenty debates before live audiences since 1981, I sent my published case to the opponent a month beforehand, so he or she would be better able to find any weak points. I also wanted them to know my position, not what they thought it was based on what others said. Be cautious of arguments from those who only wish to state their disagreement at a time and in a forum in which I cannot respond.

2. "The evidence against evolution is bad science."

Response: Have you studied the evidence? [See Parts I and II of this book.] Both sides of this issue tend to think the other is defending "bad science," but "good" evidence may exist on both sides. Why not teach all the major scientific

evidence? Evolutionists avoid a thorough, publishable, head-to-head comparison of the evidence for and against evolution. [See pages 570–571.] In fact, evolutionist leaders advise others never to participate in even an oral scientific debate on the evidence for and against evolution. In what other major science controversy has one side refused to allow all the evidence to be presented?

3. "If you are going to teach an alternate view to evolution, why not teach chemistry AND alchemy, heliocentrism AND geocentrism, gynecology AND the stork 'theory,' or astronomy AND astrology?"

Response: If anyone has scientific evidence for these fringe beliefs, I would be happy to lay out the counterevidence. (Remember, evidence must be observable and verifiable.) Millions of people know evidence that opposes evolution. Even polls conducted by evolutionist organizations have shown that about 80% of the American public want such evidence taught in their tax-supported schools.

4. "National science standards call for the exclusive teaching of evolution."

Response: There are no "national science standards." Three private, *nongovernmental*, national organizations (The National Science Teachers Association, The American Association for the Advancement of Science, and The National Research Council) have a long record of promoting evolution. Each has proposed a different science curriculum, all with a common theme—evolution.

Some may think the National Research Council is part of the federal government. No. The National Research Council is a private organization set up to advise elements of the federal government *when invited* on matters of science and technology. None of these self-appointed groups has any charter for establishing national standards in any academic discipline. **There are no "national science standards."**

5. "Almost all scientists accept evolution."

Response: No, they don't. The only study that I am aware of that addressed this question was a survey of chemists. A slight majority rejected evolution. [See Endnote 1 on page 557.] Most professors in the basic sciences favor

evolution, primarily because that is what they were taught and those who openly reject evolution are fired or not hired.

In the applied sciences (engineering, computer science, medicine, etc.) and among scientists in industry, those accepting and rejecting evolution may be nearly balanced. This mix of views comes from two opposing forces: the dominance of evolution in the media and everyone's schooling, and the independence and practical thinking of most in the applied sciences. Consequently, in the applied sciences, evolution is not universally accepted. Engineers, for example, learn to design things and appreciate complexity when they see it. They know that matter and energy, left to themselves, do not produce complexity; in general, the more time that passes, the more things degrade.

Gallup polls have shown that more Americans are creationists (46%) than theistic evolutionists (32%) or atheistic evolutionists (15%). [See page 557.] Of course, scientific conclusions should be based on evidence, not a vote. The founders of modern science (Kepler, Bacon, Pascal, Boyle, Galileo, Hooke, and Newton—who, by the way, were creationists and opposed the evolutionary views of their day) based decisions on evidence. In contrast, the science of a pre-scientific era was based on philosophical deductions or authoritative opinions. By that criterion, most of us would believe in a flat Earth, because at one time most people believed that the Earth was flat.

6. *“People who oppose evolution do so for religious reasons.”*

Response: In some cases. In other cases, some people who want to suppress the evidence against evolution do so for *their* religious reasons. Let's just agree to stick to the scientific evidence on both sides of the origins issue.

In the first half of my life, I was an evolutionist. My basic Christian beliefs have not changed, but after learning some convincing evidence, I had to reject evolution. Yes, the origins issue has religious implications for everyone—even those who claim to hold no religious views. But the issue can be addressed from a purely scientific standpoint, as they are in Parts I and II of this book. I have always advocated excluding religious matters from our public-school science classes. However, all the science should be taught. Censoring the evidence opposing evolution should not be tolerated.

7. *“Speaking of a creator or a global flood is religious, because those ideas are drawn directly from the Bible.”*

Response: Speaking of Noah's flood would be religious, but explaining geological features caused by a global flood would not be. [See pages 109–433.] Speaking of Adam or Eve would be religious, but describing the evidence related to the “mitochondrial Eve” or the “genetic Adam,” from whom all humans recently descended, is not. [See pages 534–536.] Referring to the God of the Bible or Allah of the Qur'an as the Creator would be religious, but speaking of a creator is not. As Supreme Court Justice Scalia wrote:

“to posit a past creator is not to posit the eternal and personal God who is the object of religious veneration.” Scalia also wrote, *“We will not presume that a law's purpose is to advance religion merely because it happens to coincide or harmonize with the tenets of some or all religions.”*¹

For example, scientists (and some evolutionists) who understand the amazing complexity inside a living cell know it could never have evolved; it had to be created. [See [“The Elephant in the Living Room”](#) on page 17.] But science cannot say who the creator was. It might have been several creators or even “little green men” from Mars. But when one understands the evidence, it is clear that this amazing complexity could not have evolved. It is hard to imagine an unbiased person who understands the evidence reaching any other conclusion. Unfortunately, few educators and scientists have heard this evidence. (Unintended ignorance is excusable. Unwillingness to learn is not. Preventing students from learning is reprehensible.)

Because much scientific evidence is being censored from our schools, a small but growing number of individuals, such as myself, are explaining this evidence to others. People, including scientists, are excited about what they are learning. Demand for speakers and information exceeds what we can give. If the schools did their job, this rapidly-growing endeavor would shrink. But today, parental dissatisfaction with public schools in general, and science education in particular, has never been higher—in large part because of the one-sided way origins has been taught.

8. *“The courts have stated that teaching evidence for creation would violate the separation of church and state.”*

Response: Wrong. The U.S. Supreme Court said just the opposite. A few evolutionist organizations, the ACLU, and many media outlets have propagated that myth. The Supreme Court actually said that the scientific evidence for any theory of origins, including creation, has always been legal in the classroom.

*Moreover, requiring the teaching of creation science with evolution does not give schoolteachers a flexibility that they did not already possess to supplant the present science curriculum with the presentation of theories, besides evolution, about the origin of life.*²

The issue is whether the evidence *against* evolution will be taught along with that *for* evolution. Besides, the U.S. Constitution only states that *“Congress shall make no law respecting an establishment of religion, or prohibiting the free exercise thereof.”* Our founding fathers, who acknowledged the Creator in many places, including in the *Declaration of Independence*, did not want a national religion, such as the Church of England. (The phrase *“separation of church and state”* is not in the Constitution. Nor is the word “separation” or the word “church.”)

9. *“Evolution may have some problems, but they will be solved as science advances.”*

Response: Maybe. However, the opposite has been increasingly true for many decades. That is, as more has been learned, evolution appears even weaker. It is a theory in crisis, a theory without a mechanism. Let's not withhold information. Suppressing evidence is not the way to

advance science. Let's just teach the scientific evidence that is known and undisputed. Insisting that only evolution be taught amounts to indoctrination—*telling students what to think instead of teaching them how to think*. That deprives them of the opportunity to evaluate and think critically.

References and Notes

1. "Edwards, Governor of Louisiana et al. v. Aguillard et al.," *Supreme Court of the United States*, No. 85-1513, argued 10 December 1986, decided 19 June 1987, pp. 6, 20.
2. See Endnote 1 on page 550.

How Do Evolutionists Respond to What You Say?

They generally ignore it. A few will criticize the evidence in forums where I cannot respond. When I was traveling and speaking over a 20-year period (1980-1999), every host knew that I would stay an extra day if they set up a debate with an evolutionist or team of evolutionists, one of whom held a doctorate in either the applied or basic sciences. The hosts had to locate the evolutionist(s) and a neutral community leader who would act as the debate moderator. About once a year a qualified evolutionist would agree to an oral, strictly scientific debate. These debates, typically before 1,000 people, were always lively, cordial, and professionally conducted. Unfortunately, little can be covered in a 2½-hour oral debate, but a written debate could be widely distributed and carefully studied.

The best way, I believe, to clarify the creation-evolution controversy is to have a thorough, written, publishable, strictly-scientific debate where both sides present their case, much as I have in *The Scientific Case for Creation* on pages 5–107. Then, each side would respond, point-by-point, to the other side's case. Both sides would have the right to publish the finished exchange. Surprisingly, this has never been done, even though the topic has been so controversial, worldwide, for over 2 centuries. It is especially surprising in a discipline—science—that prides itself on openness and a free exchange of ideas.

I have sought such an exchange since 1980, but have not had a serious, qualified taker. Many leading evolutionists know of the offer. For over 20 years, when I spoke frequently at universities and colleges, I always offered students a \$200 finder's fee if they could find an evolutionist professor who would complete such a debate. I also made that offer (without a dollar incentive) at the end of each of my twenty oral debates. Each time, a large audience saw the evolutionist decline. Probably, you will also see this. I am repeating that offer here, but the finder's reward is now \$10,000. [See "[What Is the Written Debate Offer?](#)" on page 570.]

This is a serious offer. It also is a response you can give anyone who disagrees with anything that is in this book. Basically, you will be saying—to put it bluntly—"Put up or shut up." (Hopefully, you will convey my challenge in nicer terms.) When the critic raises his or her disagreement in the presence of others, this challenge will be especially effective.

Evolutionists give several excuses:

1. "I don't have time."

Response: Many do not have time, and of course, they need not participate. However, others have the time to write books attacking and misrepresenting creationist positions. Many are teaching what I feel are outdated, unscientific, evolutionary ideas and refuse to place themselves in a forum where they must defend what they are teaching. *If you are going to teach something, you should be willing to defend it, especially if taxpayers are paying your salary.*

2. "Creation is a religious idea. It is not science."

Response: Creation certainly has religious implications, but much scientific evidence bears on the subject. Only the scientific aspects would be permitted in this written debate. An editor would remove any religious, or antireligious, comments from the exchange. If my comments were only religious, the editor would strike them from the debate. I would have nothing left to present, so the evolutionist would win by default. (Incidentally, evolution also has religious implications.)

3. "I don't want to give creationists a forum."

Response: Of the thousands of scientific controversies, the creation-evolution controversy may be the one in which scientists most often refuse to exchange and discuss the evidence. That is an unscientific, closed-minded position.

4. ***“I don’t know enough about evolution”*** [Carl Sagan’s answer], or ***“I am qualified in only one aspect of evolution.”***

Response: A team of evolutionists could participate in the debate.

5. ***“Any debate should be in refereed science journals.”***

Response: No journal would allocate the number of pages needed for such a debate. Besides, those journals are controlled by evolutionists, so why would they provide a platform to have their beliefs criticized? Nor do they knowingly publish any of the abundant evidence opposing evolution or supporting creation or a global flood. Publishers of these journals would be severely criticized by their subscribers and

advertisers if they did. (The few evolutionists who participate in oral debates often admit how much they are criticized by other evolutionists for participating in a debate.) In a well-publicized case, one journal, *Scientific American*, withdrew a contract to hire a highly qualified assistant editor when the journal’s executives learned that editor was a creationist.

If anyone wishes to explore the written-debate idea further, see page 570. But if you ask a qualified evolutionist to participate, watch for excuses.

How do evolutionists respond to the scientific case for creation? Most try to ignore it. As you can see from the above excuses, even qualified evolutionists usually avoid a direct exchange dealing with the scientific evidence.

If God Made Everything, Who Made God?

We live in, among other things, a time dimension where one event follows another. Time passes. Everything ages. Throughout our lives, we learn that effects always have causes. We would be confused if they didn’t. Therefore, it is hard to imagine the first cause, and even harder to imagine what, if anything, preceded “The First Cause.”

Just as God created the universe and everything in it, God also created time. There was a beginning of everything, including space and time. Consequently, God is outside of space and time as well as in them. God is unchanging (I Sam 15:29, Mal 3:6, Heb 6:17, James 1:17). He had no beginning and has no ending; He sees the beginning and the end (Rev 1:8, 21:6, 22:13).

Asking who made God before time began reflects a lack of understanding—though most of us at one time have pondered the question. *No one made God; He is infinite and outside of time, and He existed before time began.*

Many years ago, one of my children asked me this question as I tucked him into bed. While I can’t remember my answer, I am sure it was inadequate. Having years to think about his question has helped me reconcile the logic of the preceding two paragraphs with what is hard to imagine.

Seeing things from God’s infinite perspective is probably as difficult for us as it is for a dog or cat to understand

what is on this printed page. If God is infinite and we are His finite creations, our limited understanding and perspective should not surprise us.

How else do we know that time began? The Bible is the most widely read book of all time. Within it, the most read page is probably the first page of Genesis. The first three words on that page

In the beginning ...

are probably the best-known group of three words of all time—the single, most widely proclaimed idea. By reading the fourth word—God—one sees that He was there at the beginning.

Another key insight comes from John 1:1.

In the beginning was the Word, and the Word was with God, and the Word was God.

Again, there was a beginning; we are also told Who was there when time began. Verses 1:2, 3, and 14 clarify these profound events even more.

For *scientifically* compelling reasons, there was a beginning. [See Items 53 and 55 on page 31.] Alternatively, you can save time and effort by reading again the first four words of the Bible—and believing them.

In the beginning, God ...

What Is the Written Debate Offer?

The following is intended to provide the public with a clear, balanced, and fair comparison of the two main explanations for how everything began. The debate topic will be:

Does the Scientific Evidence Favor Creation or Evolution?

Although this highly controversial issue has raged for over 200 years, no comprehensive creation-evolution debate has ever been published. Scientific disagreements can and should be examined openly, rationally, and without acrimony.

A \$10,000 finder's fee, held by an escrow agent, will be given to the first person who finds an evolutionist with an earned doctoral degree in an applied or basic science who

- ◆ signs the italicized agreement at the bottom of this page.
- ◆ submits his or her strictly scientific case for evolution.
- ◆ rebuts my case for creation, and
- ◆ completes the written debate.

These submissions, in the opinion of the independent escrow agent, must (1) be cordial, (2) consistent with the written debate's intent as stated in the first paragraph above, (3) have about as much clarity, organization, and detail as my case for creation and point-by-point rebuttal of the evolutionist's case, and (4) involve only scientific evidence and the logical inferences from that evidence. Religious ideas and beliefs, while possibly correct, will not be allowed.

The "no religion" rule would be violated by:

- ◆ referring to religious writings, such as the Bible or Qur'an,
- ◆ ridiculing a deity or religious belief, or
- ◆ using a religious writing to support a scientific claim.

However, using scientific evidence to reach a conclusion that happens to agree with a religious writing would not be a violation.

My case is laid out in Parts I and II (pages 1–433) and related technical notes (pages 572–609). It is also free online at www.creationscience.com. The finder will send the name, address, and phone number of the evolutionist to:

feedback@creationscience.com

and mail this agreement, signed by the evolutionist (who may also be the finder), along with one paper and one digital copy of his or her scientific case for evolution and rebuttal of my case for creation to:

Center for Scientific Creation (CSC)
5612 N. 20th Place
Phoenix, Arizona 85016

I will immediately send both the finder and evolutionist a paper and PDF (portable digital format) copy of my case. Within the following six months, I will submit my rebuttal to the evolutionist case. Then the side with the least total number of words in his or her opening case and rebuttal may have 30 days to add to that rebuttal, so the total word count equals that of the opponent.

So you can be assured of receiving the \$10,000 finder's fee if you persuade a qualified evolutionist to complete the written debate, the \$10,000 will be placed in an escrow account acceptable to you. You may select any escrow agent who is a regular (bonded) member of the American Escrow Association, or you may select an escrow agent jointly with CSC. Then CSC will send that agent the \$10,000 and his standard fee. At the same time, you will deliver both debater's cases and rebuttals to the escrow agent for evaluation, as described in the italicized paragraph above. If the debate is completed and you are the finder, you may share the \$10,000 with anyone, including the evolutionist.

Finally, during the next 30 days, either debater may remove any of his earlier arguments or evidences that he no longer feels are valid. If one debater retracts an argument, the other debater may remove his corresponding rebuttal to that argument and replace it with a like number of words in his rebuttal. This will complete the debate. Each debater must allow the other debater to publish both cases and rebuttals side-by-side, if unaltered, except for editorial changes.

An evolutionist who wishes to debate but does not have an earned doctor's degree in an applied or basic science should recruit and offer to assist such a person. A lack of recognized qualifications does not mean a person has nothing to contribute. However, without scientific credentials, readers may dismiss that side's case or blame a weak case, not on poor science, but on the debater's lack of scientific qualifications.

This offer ends when someone collects the finder's fee or when our website (www.creationscience.com) provides a verifiable reason why I will no longer be able to participate.



Walt Brown
Creationist

I agree to participate as described above, have an earned doctoral degree in an applied or basic science, and own the copyright for my case that I will submit within 1 month. All figures and photos will be mine, have been purchased by me, or can be used under the fair-use provision. My 100–200 word biographical sketch and a color photograph of myself are attached. All my submissions will be in publishable, computer-readable form. Both Walt Brown and I will each have the right to publish the completed debate in book form. Later, we may agree to do it jointly.

Evolutionist

Date

What Is the Direct (Oral and Written) Refereed Exchange?

The hydroplate theory, explained in Part II of this book, shows how a catastrophic, global flood rapidly produced 25 major features of the Earth and solar system that conventional science has not explained. The theory also explains where all the flood water came from and where it went. Failure to understand the flood led to the mistaken belief that evolution happened over billions of years.

If you know any credible individuals who disagree with the hydroplate theory, but will not enter a *written*, publishable debate as explained on page 570, here is their opportunity to show, before a potentially large audience, that they have a scientific case. This is also your opportunity to see if their criticisms have merit. Critics—with your urging, if necessary—should send an email to

exchange@creationscience.com

(1) requesting a recorded telephone exchange with Dr. Walt Brown, followed with written exchanges as necessary, and (2) stating that they have read the hydroplate theory (Part II of *In the Beginning*, technical notes, and cross references). Please include full name, email and residence address, phone number, present job, academic background, and date of birth. No particular academic credentials are required.

Walt Brown can participate in a 60-minute conference-call exchange once a month. This will be recorded by goconferencecall.com and will be available to anyone immediately afterward. The recording (in MP3 and WAV formats) and its transcription can be distributed, broadcast, or posted at any website by anyone if done in its entirety. Participants may also record the call.

If more than one person wishes to engage Dr. Brown in a given month, the one with the strongest scientific credentials will be selected. Participants will be notified at least one month before each conference call, and a mutually agreeable time for the call will be arranged. CSC will post a transcript and an audio version of each month's oral/phone exchange at www.creationscience.com/podcasts/csc_exchange_podcasts.rss

A neutral moderator, jointly selected by both participants, will be a debate instructor/coach from a randomly selected university or college in the United States. The conference call will begin with the moderator introducing both participants to the listening audience and summarizing the rules—namely, that all the hydroplate theory has been read and no religion (only science) will be discussed. The “no religion” rule would be violated in this dialogue by:

- ◆ referring to religious writings, such as the Bible,
- ◆ ridiculing a deity or religious belief, or
- ◆ using a religious writing to support a scientific claim.

However, using scientific evidence to reach a conclusion that happens to correspond to a religious writing would not be a violation.

After introducing both participants, the moderator will ask the hydroplate critic two questions:

- ◆ Is it correct that you have read the hydroplate theory?
- ◆ What is your first criticism of the theory?

Then, Dr. Brown will respond and the discussion will focus on the critic's topics and related issues. The moderator's role is not to interview participants, but to enforce the rules and ensure that both sides have about the same speaking time and questioning opportunities. If either side engages in religion or unprofessional comments (repeated interruptions, insults, shouting, etc.) the moderator may terminate the discussion or edit out such remarks.

If the moderator concludes that the hydroplate critic did not *carefully read* the theory, as previously claimed, the moderator will suspend the exchange until the critic reads it. Obviously, a critic's credibility falls apart if it becomes clear that he has not read (or does not understand) what he is criticizing. Dr. Brown will not be expected to take his limited speaking time to explain relevant portions that the opponent has not read. However, Brown can raise issues and questions on portions of the theory related to criticisms.

Also, the breadth of the hydroplate theory—purportedly explaining the origin of mountains, volcanoes, coal, oil, the Grand Canyon, earthquakes, ocean basins, the ice age, the Ring of Fire, frozen mammoths, fossil sorting, layered strata, rapid continental drift, Earth's inner and outer core, magnetic field, meteorites, asteroids, Earth's radioactivity, comets, and dozens of other unexplained features—makes a thorough reading even more imperative. *The events that formed each feature often relate to and support those that formed other features—and a global flood.* Dr. Brown will be happy to read before the exchange the critic's written objections to the hydroplate theory. If complex issues are raised, the exchange could be continued a following month with calculations and writings exchanged during the interim.

Part II of this book, pages 109–433 and associated cross references (including technical notes), explain the hydroplate theory. A 170-word summary of the theory is on page 48, and a one-chapter summary begins on page 111.

You may hear of an alleged flaw in the hydroplate theory. Be advised that based on dozens of personal interview by independent people, almost all critics have not read the theory, choose to be anonymous, will not put their science to the test before Dr. Brown (as he will before them), or are scientifically uninformed. *This may explain why no one, as of this writing, has accepted this balanced offer.* If you press the critic to bring the alleged problem directly to Walt Brown and before a neutral moderator and a large listening audience, you will help prevent the spreading of misinformation, see the critic's true confidence, and help us all get much closer to the truth.

Technical Notes

Calculations That Show Comets Began Near Earth

If the most clocklike comets can be shown to have begun near Earth with a very high probability (>99%), one can also directly conclude with a high probability that:

- ◆ The hydroplate theory is basically correct.
- ◆ Beginning in about 3290 ± 100 B.C., a powerful catastrophe launched massive amounts of rocks and water from Earth into space. Some of that material later merged by known forces to become comets.

If these conclusions are shocking to some individuals, here is their challenge: *Find an error in the calculations outlined below, or seriously consider the mathematical conclusions.*

For more details, see “**When Was the Flood, the Exodus, and Creation?**” on pages 482–484.

Step 1: Download from the internet the two papers referenced in Endnote 5 on page 484.¹ They are located at

<http://adsabs.harvard.edu/full/1981MNRAS.197..633Y>

and

<http://adsabs.harvard.edu/full/1994MNRAS.266..305Y>

After reading both papers, set up a workbook in Excel 2007 (or higher) with the following worksheets:

- a. Most Clocklike Comets
- b. True Deviations Squared
- c. Random Deviations Squared

Data and calculations from worksheets a–b will feed into subsequent worksheets.

Set up a table in the “Most Clocklike Comets” worksheet similar to [Table 40](#) and fill in all 49 rows. The yellow cells will require simple calculations. Select any Julian date converter on the internet and become comfortable converting from calendar dates to Julian dates and vice versa.

Table 40. Comet Convergence, Most Clocklike Comets (Step 1)

	A	B	C	D	E	F	G	H
1	Comet Halley				Comet Swift-Tuttle			
2	Perihelion Date (Calendar Date)	Julian Date	Latest Period Based on Julian Date (years)	Change in Period (years)	Perihelion Date (Calendar Dates)	Julian Date	True Period Based on Julian Date (years)	Change in Period (years)
3	-1403 Oct 15.68109	1208900.181090			-702 Apr 3.28685	1464744.786850		
4	-1333 Aug 25.50585	1234416.005850	69.860013		-573 Aug 1.41288	1511981.912880	129.330965	
5	-1265 Sep 5.39589	1259263.895890	68.031268	1.83	-446 Jun 2.14601	1558308.646010	126.838391	2.49
6	-1197 May 11.23252	1283983.732520	67.680670	0.35	-321 Sep 27.65803	1604082.158030	125.323722	1.51
...
47	1910 Apr 20.1785	2418781.677710	74.423873	2.26	1862 Aug 23.42278	2401375.922278	125.186982	2.17
48	1986 Feb 9.4589	2446470.958343	75.810738	-1.39	1992 Dec 12.32394	2448968.823940	130.305046	-5.12
49	Sample Standard Deviation of Period Changes (years):			1.56	Sample Standard Deviation of Period Changes (years):			2.98
1 year = 365.2422 days								

Step 2: Set up a table in the “True Deviations Squared” worksheet similar to [Table 41](#). Designate a row in column B for each of the past 4,000–6,000 years. In column C, calculate the corresponding Julian dates. In columns D and E (for comets Halley and Swift-Tuttle, respectively), calculate the number of days until (or since) that comet’s nearest perihelion. Square that number, and place the sum of those two squared numbers in the corresponding row in

column G. Place the minimum of the numbers in column G in cell G1 and the corresponding Julian date and calendar date in cells G2 and G3. That is the year in which the three bodies (Halley, Swift-Tuttle, and Earth) were closest to each other. However, the degree of closeness may not be statistically significant. That significance will be determined in Step 3. Plot column G vs. column B (time), as shown in [Figure 257](#).

Table 41. Comet Convergence, True Deviations Squared (Step 2)

	A	B	C	D	E	F	G
1				Comet Halley	Comet Swift-Tuttle	Minimum Sum of Squares in Column G:	1,210
2	Oldest Known Perihelion			1208900.181090	1464744.786850	Julian Date:	519968
3	Oldest Period (Julian Days)			25515.82	47237.13	Calendar Date:	3290 B.C.
4		Years Ago	Julian Date	Deviations from Perihelion Squared (Julian Days) ²			Sum of Columns D and E
5		4000	995513	85,717,656	9,870,112		95,587,768
6		4001	995148	92,614,162	7,708,570		100,322,733
7		4002	994783	99,777,472	5,813,833		105,591,305
8		4003	994417	107,207,586	4,185,899		111,393,484
...	
2004		5999	265394	377,999	339,907,280		339,656,279
2005		6000	265029	46,714	352,907,638		352,954,352

Excel spreadsheets have built in functions that can save you a great deal of time. Consider using the functions: SQRT (square root), STDEV (sample standard deviation), MIN (minimum), and RAND (random number). Also macros can repeat complex operations in milliseconds.

Step 3: In the “Random Deviations Squared” worksheet, repeat Step 2, but begin each comet’s backward march from a random point on its oldest known orbit instead of its perihelion. With a macro, repeat this process 1,000,000 times (for the time interval 4,000–6,000 years ago) and see what percent of those random trials produced a clustering at least as tight as you got in Step 2. Your answer should be only about 0.6 of 1%. Alternatively, if we began each comet’s backward projection from a random point on its oldest known orbit, we would have to search 333,333 years, on average, to find one clustering that was at least as tight. $[2,000/(0.006)= 333,333]$

Step 4: Calculate the expected error for each comet individually. Those errors can be determined by three different methods: A, B, and C. All give the same answer. Method A, a simple, intuitive approach, will now be explained using comet Halley as an example.

Method A: Geometric. Visualize a timeline extending back in time from Halley’s oldest known perihelion in 1403.80 B.C. If we tick off exactly 27 69.86-year increments on that timeline, we will be at 3290 B.C.—our best estimate for the time of the flood, but an estimate with some uncertainty on either side of 3290 B.C. How large is that uncertainty?

Method B: Algebraic. For a particular comet:

- t_0 : the Julian date for the oldest known perihelion
- t_i : an estimate of the Julian date for the i^{th} unknown perihelion
- P_0 : the oldest known period

Our best guess for all 27 time increments was the oldest known period (69.86 years), but there is an unknown error, x_1 , in the first unknown orbital period. That first period, now with a known but slightly different length of $69.86 + x_1$, becomes our best guess for all earlier periods, making the total error in our 3290 B.C. date for the flood, based just on the length of the first unknown period, 27 times x_1 . (The random number, x_1 , will be drawn from a normal distribution with a mean of zero and a standard deviation of 1.56 years.) With that first unknown period now known, we can repeat these steps for the next unknown period. That adds an error of 26 times x_2 . Generalizing, the expected error for either comet becomes:

Total Error =

$$N x_1 + (N-1)x_2 + (N-2)x_3 + \dots + 3x_{N-2} + 2x_{N-1} + x_N$$

where N, the number of periods a comet must take in going from its oldest known perihelion back to the best estimate for the time of the flood. For comet Halley, $N=27.000$. For comet Swift-Tuttle, $N=20.000$. Because the Total Error above is the sum of N *independent* random variables, such as Nx_1 and $(N-1)x_2$, the standard deviation of the Total Error is

$$\begin{aligned} & \sigma \sqrt{N^2 + (N-1)^2 + (N-2)^2 + \dots + 3^2 + 2^2 + 1^2} \\ & = \sigma \sqrt{\frac{N(N+1)(2N+1)}{6}} \end{aligned}$$

For comets Halley and Swift-Tuttle, these values are 130 years and 159 years, respectively.

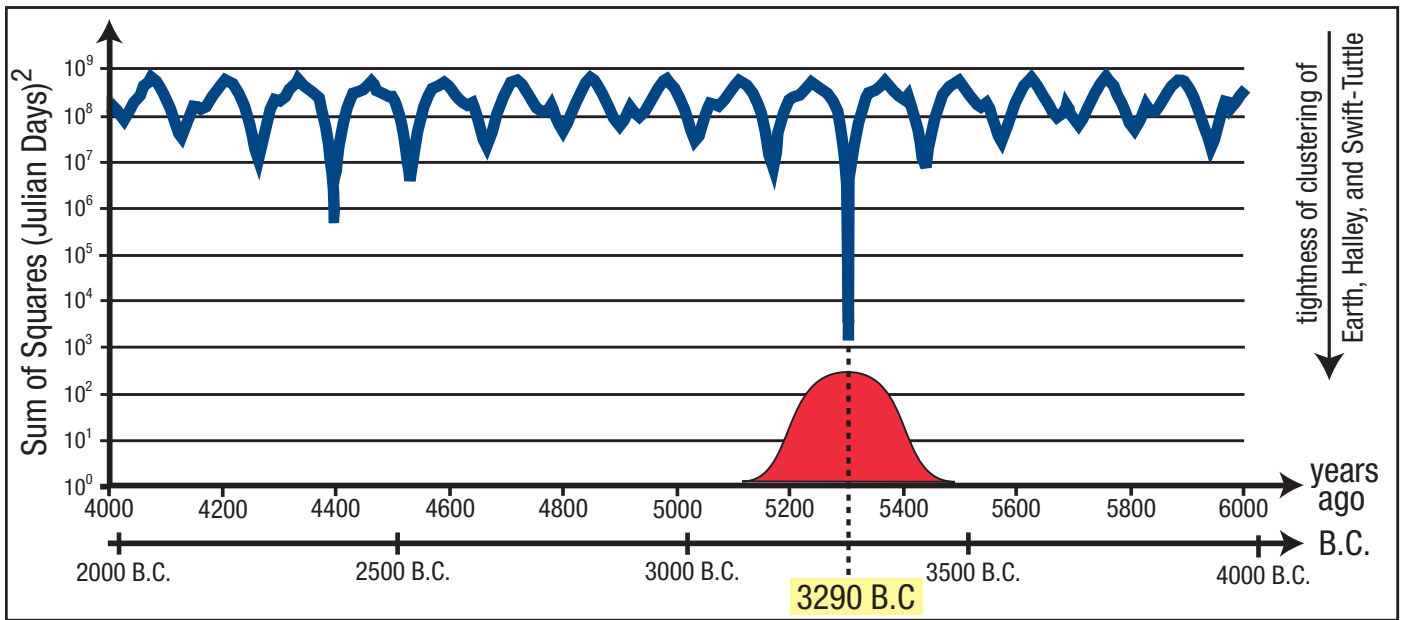

Figure 257: Comet Clustering. The tight clustering of comets Halley and Swift-Tuttle with Earth in 3290 B.C. (as shown above) does not mean that was the year of the flood. It simply means that 3290 B.C. is the most likely year of the flood, based on these calculations. As shown by the red normal distribution, the flood could have occurred within a hundred or so years of that date. The depth of this downward spike in 3290 B.C., however, is quite unusual. Had the backward projection of Halley and Swift-Tuttle started at a random point on their oldest known orbits instead of at their perihelions, it would take, on average, 333,333 years before a similar tightness of clustering of these three bodies (Earth and comets Halley and Swift-Tuttle) would be found. Is it merely a coincidence that we found a one-in-333,333-year event very near the time of the historical global flood—after a backward search of only 1290 years?

Also, basic physics tells us that gravitational perturbations are as likely to increase a comet’s period as to decrease a comet’s period; that is, a gravitational body, such as a planet, is as likely to pass in front of an orbiting comet at a certain distance as to pass behind it at that distance. While we may not know how the unknown periods changed, the *statistical* mean of those changes will be zero; therefore, **the mean of the possible dates for the flood is 3290 B.C.**

P_i : an estimate for the i^{th} unknown period

x_i : the i^{th} random variable from a $[0, \sigma]$ normal distribution of the changes in successive orbital periods of a comet

$$\begin{aligned}
 t_1 &= & t_0 - P_0 + x_1 & & P_1 = t_0 - t_1 & & P_0 - x_1 \\
 t_2 = t_1 - P_1 + x_2 = (t_0 - P_0 + x_1) - (P_0 - x_1) + x_2 &= & t_0 - 2P_0 + 2x_1 + x_2 & & P_2 = t_1 - t_2 = P_1 - x_2 = (P_0 - x_1) - x_2 &= & P_0 - x_1 - x_2 \\
 t_3 = t_2 - P_2 + x_3 = (t_0 - 2P_0 + 2x_1 + x_2) - (P_0 - x_1 - x_2) + x_3 &= & t_0 - 3P_0 + 3x_1 + 2x_2 + x_3 & & P_3 = t_2 - t_3 = P_2 - x_3 = (P_0 - x_1 - x_2) - x_3 &= & P_0 - x_1 - x_2 - x_3 \\
 & & \dots & & & &
 \end{aligned}$$

$$t_N = t_0 - NP_0 + Nx_1 + (N-1)x_2 + (N-2)x_3 + \dots + 3x_{N-2} + 2x_{N-1} + x_N$$

Methods A and B produce identical results and have probability distributions that depends on only σ and N .

Method C: Simulation. Instead of working with the long summations in Method B, a computer can generate each x_i as a random number from a $[0, \sigma]$ normal distribution and substitute them in the equations:

$$\begin{aligned}
 t_1 &= t_0 - P_0 + x_1 & P_1 &= t_0 - t_1 \\
 t_2 &= t_1 - P_1 + x_2 & P_2 &= t_1 - t_2 \\
 t_3 &= t_2 - P_2 + x_3 & P_3 &= t_2 - t_3 \\
 & \dots & & \\
 t_N &= t_{N-1} - P_{N-1} + x_N
 \end{aligned}$$

Each sequence of N random numbers (x_1, x_2, \dots, x_N) will give one simulated date for the flood, which will, in general, differ from 3290 B.C. Thousands of those simulated dates will give us the error estimates for each comet individually (of 130 and 159 years) that were found exactly in Methods A and B. Adding the additional information that both comets formed at about the same time—based on the statistical significance of >99%—allows the combined error estimate for the date of the flood to be reduced to ± 100 years.

Figure 258: Probabilities for Perihelion Passage Dates. We have shown that if comets Halley and Swift-Tuttle had been projected back in time from their oldest known perihelions and *with their oldest known periods*, both comets would pass perihelion in the year 3290 B.C. Halley would have taken exactly 27 orbits and Swift-Tuttle exactly 22 orbits.

We also showed how unusual it is for both comets to be so close to Earth in any single year in the 2,000-year window in which almost all Bible scholars place the flood. Such a tight convergence would only happen 0.6 of 1% of the time. Nevertheless, the hydroplate theory explains why they were so close in the year of the flood.

Of course, each comet's period would have changed slightly with each orbit, so while the year 3290 B.C. might be our best guess if we had to pick only one year for the comet's simultaneous convergence with Earth, other years for the three-body convergence are also possible on either side of 3290 B.C. Projecting Halley back 27 orbits and allowing planetary perturbations similar to those seen with Halley's most recent 45 orbits give us the distribution of possible years shown in Figure A above. Likewise, Figure B above gives the probability distribution of the possible years in which Swift-Tuttle passed perihelion on its 22nd orbit back in time from where we know it was on 702.30 B.C.

Finally, we have one other piece of information. Given that we are 99.4% confident that Halley and Swift-Tuttle were both near Earth in the same year, we will add the constraint to Figures A and B above that Halley made its 27th perihelion pass in the same year Swift-Tuttle made its 21st perihelion pass.

It can be shown, with some calculus and probability theory, that distribution C gives the probabilities—for each of the years on either side of 3290

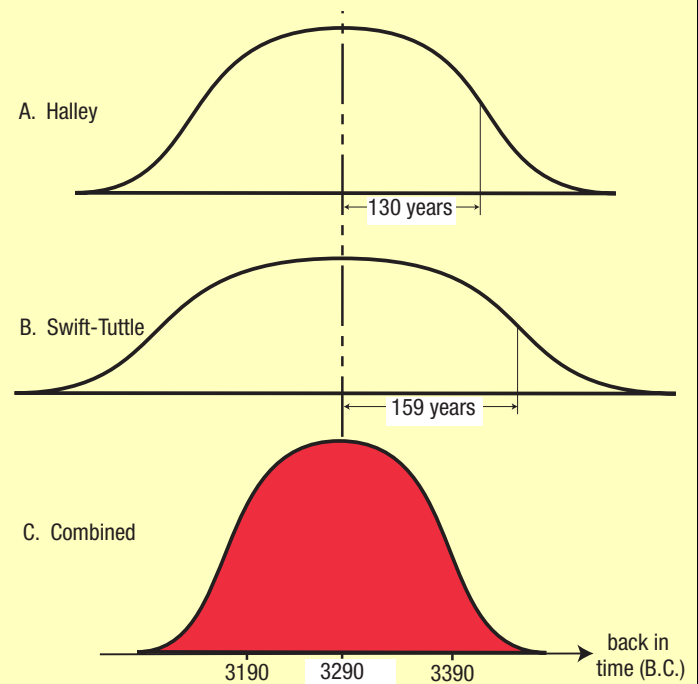

B.C.—that both comets were simultaneously near Earth on a single year. That distribution has a standard deviation (σ_c) of

$$\frac{1}{(130)^2} + \frac{1}{(159)^2} = \frac{1}{\sigma_c^2}; \quad \sigma_c \approx 100 \text{ years}$$

where Halley's and Swift-Tuttle's standard deviation in Figures A and B above were 130 years and 159 years, respectively.

References and Notes

1. For comet Halley, the computation by Kiang and Yeomans was terminated in 1404 B.C., because Halley passed close to Earth (0.04 AU). Earth's gravitational perturbation would have injected a large error that could not be rectified by a human observation even further back in time. With comet Swift-Tuttle, the backward computation by Yeomans et al. was terminated in 702 B.C for a similar reason.

Ending the backward projection was proper, because too much precision would have been lost for all earlier dates. An analogous situation occurs if someone is adding a thousand numbers, one of which has great uncertainty compared to all others. It makes no sense to claim high precision for the sum or to strive for further precision for the 999 good numbers when one number has little accuracy. That low precision number becomes the weak link in the chain.

However, with the statistical method used here, we are not forcing Halley and Swift-Tuttle to pass through (or near) points in space at specific times long ago. We are only looking for the tightest clustering of three bodies (Halley, Swift-Tuttle, and Earth) within a 2,000-year window: 4,000–6,000 B.C. Then we compare that tightness with the tightest clustering of those three bodies in that same 2,000-year window for each of a million **random** orbits of the two comets back to 6,000 B.C. Using the same step-back procedure, each of the million “step backs” begins not at their earliest known perihelion point, but at a random point on its earliest known orbit.

It turns out that less than 1% of the random orbits can produce a tighter clustering. Therefore, even though each comet experienced a large perturbation error, less than 1% of the random orbits could beat our actual orbit—a highly significant result.

How Long Would It Take the Moon to Recede from Earth to Its Present Position?

Evolutionists believe (1) the Earth and Moon are 4.6-billion years old, and (2) with enough time bacteria will change into people. We have all heard some evolutionists say, “Given enough time, anything can happen.” This simplistic attitude overlooks two things. First, most conceivable events will not happen, because they would violate well-established laws of science.¹ Second, if 4.6-billion years have elapsed, many things should have occurred that obviously have not. Instead of time being “the hero of the plot,” as one prominent evolutionist stated,² immense amounts of time cause problems for evolution, as you will now see.

Most dating techniques, including the majority that indicate young ages, make the three basic assumptions given on page 36. The following dating technique has few, if any, major assumptions. It relies basically on only the law of gravity and one undisputed and frequently repeated measurement. We will look at the forces causing the Moon to spiral farther and farther from Earth. Then, we will see that this spiraling action could not have been happening for the length of time evolutionists say the Earth and Moon have been around.

It will be shown that if the Moon began orbiting very near the Earth, it would move to its present position in less than 1.2-billion years. Stated another way, if we could run time backwards, in 1.2-billion years the Moon would be so close to Earth that ocean tides would sweep over all mountains. Astronomers who are aware of this problem call it “the lunar crisis.”³ Notice that this conclusion does not say the Earth-Moon system is 1.2-billion years old; it only says that the Earth-Moon system must be *less than* 1.2-billion years old. If the Moon began orbiting Earth anywhere inside the Moon’s present orbit, its age would be less. Obviously, something is wrong with either the laws of gravity and conservation of angular momentum or evolutionists’ belief that the Earth-Moon system is 4.6-billion years old. Most astute people would place their confidence in these two laws, which have been verified by countless experiments.

What causes tides? If the Moon’s gravity attracted every particle in and on Earth with equal force, there would be no tides. Tides are caused by slight differences in the Moon’s gravitational forces throughout Earth.⁴ As shown in Figure 259, the Moon pulls more on ocean particle A, directly under the Moon, than it does the center of Earth, C, because A is closer to the Moon. Therefore, A, pulled with slightly more force, moves proportionally farther toward the Moon than C, creating a tidal bulge. Likewise, water particle B, on the far side of Earth, is pulled with slightly less force than C. This difference pulls Earth away from B, creating the far tidal bulge.

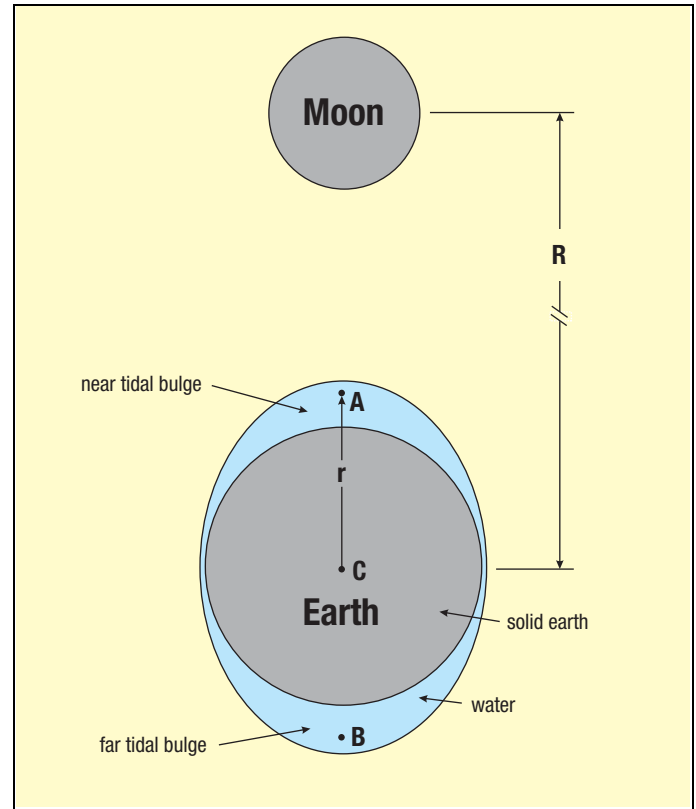

Figure 259: Why the Moon Produces Tides on Earth.

How does the height of ocean tides relate to the Earth-Moon separation distance (R)? According to Newton’s law of gravitation, the Moon’s gravitational force pulls on Earth’s center of mass (C) with a force proportional to $1/R^2$. Water particle A directly under the Moon is one Earth radius (r) closer, so it is pulled by a force proportional to $1/(R-r)^2$. The difference between these forces is proportional to

$$\frac{1}{(R-r)^2} - \frac{1}{R^2} = \frac{R^2 - (R-r)^2}{(R^2)(R-r)^2} = \frac{2rR - r^2}{(R^2)(R-r)^2} \quad (1a)$$

Because r is much less than R , the numerator on the right is almost $2rR$ and its denominator is almost R^4 . Therefore, the force difference producing tides and tide heights is approximately proportional to

$$\frac{2rR}{R^4} = \frac{2r}{R^3} \quad (1b)$$

Because Earth’s radius (r) is constant, we can conclude that the height of the tides is proportional to $1/R^3$. For example, if the Earth-Moon distance suddenly doubled, tides caused by the Moon would be only 1/8 as high.⁵

How do tides affect the Moon’s orbit and the Earth’s spin rate? Surprisingly, the tidal bulges do not line up directly

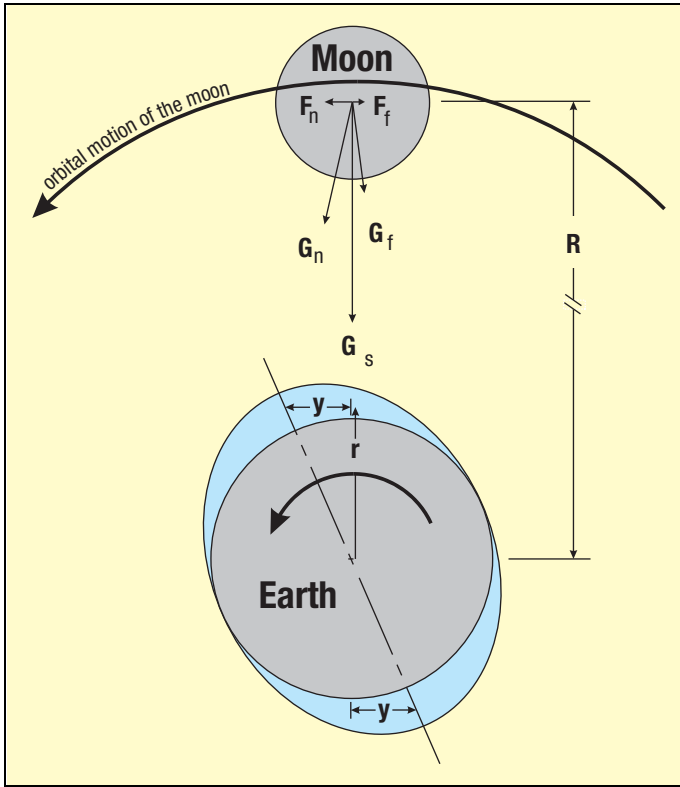

Figure 260: Rotated Tidal Bulges.

under the Moon as shown in Figure 259. This is because the spinning Earth carries the bulges out of alignment as shown in Figure 260. If Earth spun faster in the past, as we will see, the misalignment would have been even greater.

Let's think of Earth as composed of two parts: a spherical portion (gray in Figure 260) and the tidal bulges—both water and solid tides.⁶ G_s is the gravitational force the Moon feels from the spherical portion of Earth. Because G_s is aligned with the centers of Earth and Moon, it does not alter the Moon's orbit. However, the near tidal bulge, because it is offset, pulls the Moon in a direction shown by G_n , with a tangential component, F_n , in the direction of the Moon's orbital motion. F_n accelerates the Moon in the direction it is moving, flinging it into an increasingly larger orbit. The far tidal bulge has an opposite but slightly weaker effect—weaker because it is farther from the Moon. The far bulge produces a gravitational force, G_f , and a retarding force on the Moon, F_f . The net strength of this accelerating force is $(F_n - F_f)$. It can also be thought of as a thrust pushing the Moon tangential to its orbit, moving the Moon farther from Earth. This accelerating force allows us to calculate an *upper limit* on the age of the Moon. Today's recession rate has been precisely measured at 3.82 cm/yr,⁷ but as you will see, it was faster in the past.

Notice, the Moon's net gravitational pull acting on the tidal bulges steadily slows Earth's spin. Simply stated, the Earth spun faster in the past.

How does $(F_n - F_f)$ relate to the Earth-Moon separation distance (R)? Using similar triangles,

$$\frac{F_n}{G_n} = \frac{y}{\sqrt{(R-r)^2 + y^2}} \approx \frac{y}{R-r} \quad \frac{F_f}{G_f} = \frac{y}{\sqrt{(R+r)^2 + y^2}} \approx \frac{y}{R+r}$$

$$G_n = \frac{Gmm_b}{(R-r)^2} \quad G_f = \frac{Gmm_b}{(R+r)^2}$$

where y is the misalignment distance of each tidal bulge, m_b is the mass of each tidal bulge, m is the Moon's mass, and G is the gravitational constant. Solving for $(F_n - F_f)$

$$(F_n - F_f) \approx 6rGmy \left(\frac{m_b}{R^4} \right)$$

Equation 1b showed that the mass of a tidal bulge, m_b , is approximately proportional to $1/R^3$, that is

$$m_b = \frac{C_1}{R^3}$$

where C_1 is the constant of proportionality. Therefore

$$(F_n - F_f) \approx 6rGmy \left(\frac{C_1}{R^7} \right) \quad (2)$$

The velocity of the Moon (or any body in a circular orbit) is

$$V = \sqrt{\frac{G(M+m)}{R}}$$

where M is Earth's mass (or the mass of the central body).

Differentiating both sides with respect to time (t) and solving for $\frac{dR}{dt}$ gives

$$\frac{dR}{dt} = (-2) \left(\frac{dV}{dt} \right) \frac{R^{\frac{3}{2}}}{\sqrt{G(M+m)}}$$

Because the Moon's tangential acceleration, $\frac{dV}{dt}$, is equal to $\frac{(F_n - F_f)}{m}$, which is known from equation (2)

$$\frac{dR}{dt} = (-2) \left(6rGy \frac{C_1}{R^7} \right) \frac{R^{\frac{3}{2}}}{\sqrt{G(M+m)}} \quad (3)$$

The slight displacement of the tidal bulge (y), as mentioned earlier, is proportional to the difference in the Earth's spin rate (ω) and the Moon's angular velocity (ω_l). In other words,

$$y = C_2 (\omega - \omega_l) \quad (4)$$

Substituting (4) into (3) and replacing the product of all constants by C gives

$$\frac{dR}{dt} = \frac{C(\omega - \omega_L)}{R^{\frac{11}{2}}} \quad (5)$$

C is found by using today's values (subscript t)

$$C = \left(\frac{dR}{dt} \right)_t \frac{R_t^{\frac{11}{2}}}{(\omega - \omega_L)_t} \quad (6)$$

Kepler's third law shows how $(\omega - \omega_L)$ varies with R:

$$\omega_L = \sqrt{\frac{G(M+m)}{R^3}} \quad (7)$$

Applying the law of conservation of angular momentum gives

$$P\omega + \frac{Mm}{M+m} R^2 \omega_L = L$$

where the constant L is the angular momentum of the Earth-Moon system, and P is Earth's polar moment of inertia. Combining (7) and (8) gives

$$\omega = \frac{L}{P} - \frac{Mm}{P} \sqrt{\frac{GR}{M+m}} \quad (9)$$

Substituting (6), (7), and (9) into (5) gives us the final equation. Because it has no closed-form solution, it will be solved by numerical iteration. The steps begin by setting the clock to zero and R to its present value of 384,400 km. Then, time is stepped backwards in small increments (dt) until the centers of the Moon and Earth are only 15,000 km apart. Had this happened, ocean tides would have steadily grown to a ridiculous 12.8 km (8 miles) high and left marks on Earth that obviously don't exist.⁸

$$R_{i+1} = R_i - \left[\frac{C}{R_i^{\frac{11}{2}}} (\omega - \omega_L)_i \right] dt \quad \text{from (5)}$$

$$t_{i+1} = t_i + dt$$

$$\omega_{i+1} = \frac{L}{P} - \frac{Mm}{P} \sqrt{\frac{GR_i}{M+m}} = \frac{L}{P} - b R_i^{\frac{1}{2}} \quad \text{from (9)}$$

$$(\omega_L)_{i+1} = \sqrt{G(M+m)} R_i^{-\frac{3}{2}} = a R_i^{-\frac{3}{2}} \quad \text{from (7)}$$

The QuickBasic program that solves this system of equations (shown on page 579) gives *1.2-billion years as the upper limit for the age of the Moon*. (If the Moon began moving away from Earth 1.2-billion years ago, the Earth would have rotated once every 4.9 hours.)

Two complicated effects were neglected that would further reduce this upper limit for the Moon's age.⁹

1. Evolutionists believe that the Earth formed by gravitational accretion of smaller bodies. If so, the impacts would have left a molten Earth. The Earth, throughout its history, would have been less rigid than it is today. Therefore, tidal bulges would have been larger, causing the Moon to spiral away from the Earth even faster than we calculated here.
2. Internal friction from tidal stretching of the solid Earth reduces Earth's spin velocity. This greater spin velocity in the past would have increased the tidal misalignment, so the Moon's recession would have been greater than calculated above.

Incorporating these effects into the above analysis would make the *upper limit* on the Moon's age much less than 1.2-billion years.

One might argue that 1.2-billion years ago the Moon was captured by the Earth or blasted from the Earth by an extraterrestrial collision.¹⁰ These events would have placed the Moon in a very elongated orbit. Today, Earth's Moon and most of the almost 200 other known moons in the solar system are in nearly circular orbits.¹¹ Those many circular, or nearly circular, orbits are difficult for evolutionists to explain with any rigor.¹² Therefore, it is highly unlikely that the Moon (1) was captured, (2) was blasted from Earth by an extraterrestrial collision, or (3) somehow began orbiting Earth 1.2-billion years ago. Its orbit is too circular. (Other problems with evolutionary theories on the Moon's origin are discussed under "**Origin of the Moon**" on page 29.)

Besides mountain-eroding tides, what other implications would a 1.2-billion-year-old Moon have for organic evolution and the age of Earth? Evolutionists claim that certain fossils are 2.8–3.5-billion years old. Had the Moon begun orbiting Earth 1.2-billion years ago, such fossils would have been pulverized by the havoc of gigantic tides. Evidently, the Moon did not originate near Earth. This further reduces the maximum age of the Moon.

All other dating techniques must assume how fast the dating clock has always ticked and how the clock was initially set. For example, radiometric techniques ignore the accelerated decay that produced Earth's radioisotopes, and never consider how each radioactive isotope originated. [See "**The Origin of Earth's Radioactivity**" on pages 379–433.] The analysis on the Moon's recession only assumes that the law of gravity has existed since the Earth and Moon began. Neither assumption can be proven, but there is no doubt which assumptions scientists would favor. If Newton's law of gravitation did not hold in the past, our scientific foundations would crumble. However, if the Moon is less than 1.2-billion years old, a few evolutionary preconceptions must be discarded. But that's progress.

PROGRAM

```

DEFDBL A-Z      `DOUBLE PRECISION
dt = 1          `TIME INCREMENT (yr)
G = 6.64E-08    `THE GRAVITATIONAL CONSTANT (km3 gm-1 yr-2)
LOP = 13486.23  `ANGULAR MOMENTUM OF EARTH-MOON SYSTEM / P (1/yr)
ME = 5.97E+27   `MASS OF THE EARTH (gm)
mm = 7.35E+25   `MASS OF THE MOON (gm)
P = 8.068E+34   `EARTH'S POLAR MOMENT OF INERTIA (gm km2)
R = 384400      `TODAY'S EARTH-MOON SEPARATION DISTANCE (km)
Rdot = 0.0000382 `TODAY'S RATE OF CHANGE OF R (km/yr)
ω = 2301.22     `TODAY'S ANGULAR VELOCITY OF THE EARTH'S SPIN (rad/yr)
ωL = 83.993     `TODAY'S ANGULAR VELOCITY OF THE MOON'S ROTATION (rad/yr)
t = 0          `TIME, THE NUMBER OF YEARS AGO (yr)

```

```

a = SQR(G * (ME + mm))
b = ME * mm * SQR(G / (ME + mm)) / P
C = Rdot * R ^ 5.5 / (ω - ωL) `FROM (6)

```

```
`marching solution begins
```

DO

```

R = R - (C * (ω - ωL) / R^5.5) * dt `FROM (5)
IF R < 15000 THEN LPRINT "The upper limit on the Moon's age is"; t; "years.": END
ω = LOP - b * SQR(R)           `FROM (9)
ωL = a * R ^ -1.5              `FROM (7)
t = t + dt

```

LOOP**OUTPUT**

```
The upper limit on the Moon's age is 1,198,032,532 years.
```

References and Notes

1. If you disagree, hold a rubber ball at arm's length and release it. Of the many possible paths the ball could conceivably take (actually an infinite number), it will follow only one. As another example, compress the ball between two surfaces. Of the many possible ways the ball might deform, it will deform in a way that minimizes its stored energy. These are consequences of physical laws. Most things will not happen, even with an infinite amount of time. Protons will not turn into planets, plants, or people.
2. George Wald, "The Origin of Life," *Scientific American*, Vol. 191, August 1954, p. 48.
3. Two international conferences have tried to address this problem. [See P. Brosche and J. Sündermann, editors, *Tidal Friction and the Earth's Rotation* (New York: Springer-Verlag, 1978) and P. Brosche and J. Sündermann, editors, *Tidal Friction and the Earth's Rotation II* (New York: Springer-Verlag, 1982).] The studies presented were of mixed quality; none considered the effect described in equations 4–9, and all left this recognized problem somewhat "out of focus."
4. We will consider only the Earth-Moon interaction. The Sun's tidal effect is about half that of the Moon.
5. If a force (or a change in force) is small, the displacement it produces is proportional to the force if all states passed through are equilibrium states. For example, a small displacement of an extension spring is proportional to the force causing the displacement. This doesn't hold if the spring breaks or stretches beyond its elastic limit. Tidal forces and displacements at a particular location are quite small.
 - ◆ Once R is fixed, the tide's height at a specific location depends on many other factors, especially the shape of the coastline and seafloor. When high tides arrive at a coastline with a narrow, funnel-shaped bay, tide heights increase. At the Bay of Fundy in eastern Canada, tides rise and fall up to 48 feet twice daily. The average tidal amplitude on the open ocean is about 30 inches. Inland lakes have small tides. For example, Lake Superior has 2-inch tides.

Tides also occur in the atmosphere and solid Earth. Relative to the center of the Earth, the foundation of your home (and everything around it) may rise and fall as much as 12 inches (relative to the center of the Earth), depending on your latitude.

6. Earth's mountain ranges and equatorial bulge can be disregarded in this analysis, because their effects on the Moon's recession cancel over many orbits.
7. Laser beams have been bounced off arrays of corner reflectors left on the Moon by three teams of Apollo astronauts and the Russian Lunakhod 2 vehicle. Knowing today's speed of light and the length of time for the beam to travel to the Moon and back gives the Moon's distance. This has been successfully done more than 8,300 times since August 1986. Adjusting for many other parameters that affect the Moon's orbit gives its recession rate: 3.82 ± 0.07 cm/yr [1.5 inches per year]. [See J. O. Dickey et al., "Lunar Laser Ranging: A Continuing Legacy of the Apollo Program," *Science*, Vol. 265, 22 July 1994, p. 486.] This recession was first recognized in 1754 by observing the Moon's increasing orbital period. [For details see Walter H. Munk and Gordon J. F. MacDonald, *The Rotation of the Earth* (Cambridge, England: Cambridge University Press, 1975), p. 198.]
8. How high would tides be if the Earth-Moon distance (R) were 15,000 km? (Whether the Moon would be pulled apart if it were ever that near Earth will be bypassed. It depends on many factors, including the Moon's tensile strength, its rotation rate, and a subject called *Roche's limit*.)

From equation 1b, the tidal height varies as $1/R^3$. The average height of tides on the open ocean today (with $R = 384,400$ km) is 30 inches or 0.76 meter. [See Endnote 5, above.] Therefore, if R were ever 15,000 km, the tidal height would be

$$0.76 \times 10^{-3} \left(\frac{384,400}{15,000} \right)^3 = 12.8 \text{ km} = 8 \text{ miles}$$

Tides more than a mile high would occur if $R < 30,000$ km = 18,606 miles.

9. Touma and Wisdom conducted a more detailed study of the moon's recession than my study. However, they arrived at a similar answer.

The evolution of the lunar semimajor axis presents the well-known time scale problem; the lunar orbit collapses only a little over a billion years ago. Jihad Touma and Jack Wisdom, "Evolution of the Earth-Moon System," *The Astronomical Journal*, Vol. 108, November 1994, p. 1954.

They then ignored the problem by saying, "*Presumably, the tidal constants have changed as the continents have drifted.*"

Another problem they uncovered, but did not resolve, is that as the Moon approaches the Earth, its orbit becomes highly inclined to Earth's equator. All evolution theories for the Moon have it beginning in the plane of Earth's equator.

We are presented with an unresolved mystery. All theories of lunar formation require that formation take place in the equator plane, yet models of tidal evolution do not place the Moon there. Touma and Wisdom, p. 1955.

Recognizing that the Moon did not evolve eliminates both problems.

10. The other evolutionary theories on the Moon's origin require it to have an age of 4.6-billion years. Because we have seen that the Moon cannot be older than 1.2-billion years, and it may be much younger, these other theories can be rejected.
11. Today, the Moon's orbital eccentricity is 0.0549. A perfect circle has zero eccentricity. An extremely elongated elliptical orbit has an eccentricity of slightly less than 1.000. The ellipse in [Figure 171 on page 305](#) has an eccentricity of about 0.65.
12. Most people, even scientists, do not appreciate the difficulty of placing a satellite in a nearly circular orbit. For an artificial satellite to achieve such an orbit, several "burns" are required at just the right time, in just the right direction, and with just the right thrust. Most planets and many moons have nearly circular orbits. How could this have happened?

Rocket Science

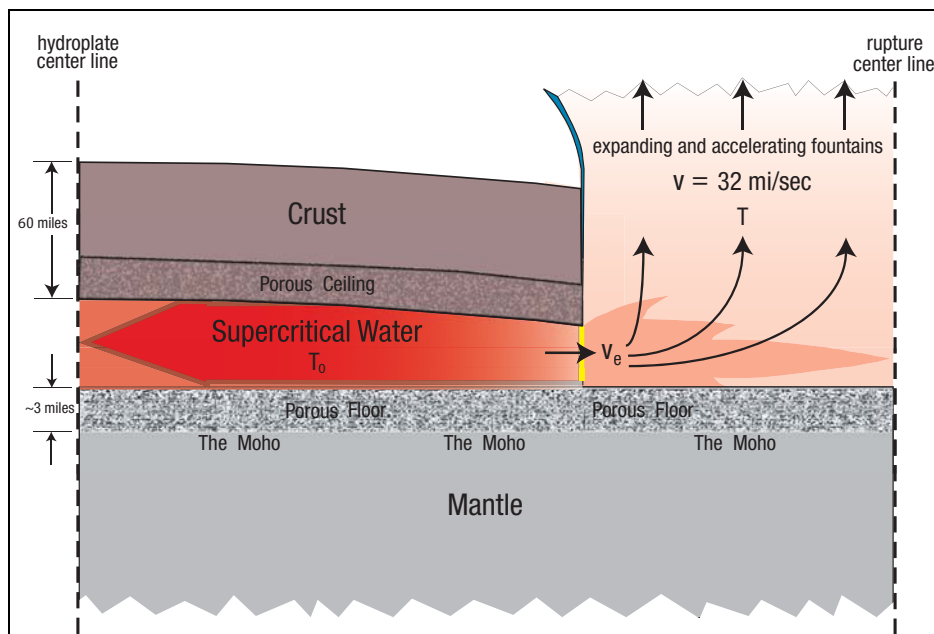

Figure 261: Jetting. Shown (not to scale) is a cross section of the Earth's crust and the jetting supercritical water (SCW) hours to weeks after the rupture. The left and right dashed lines are the vertical center lines of a hydroplate and the rupture, respectively. A mirror image of this figure (not shown) would lie to the left and right of each center line. Because of this symmetry, the dashed lines can be thought of as barriers beyond which matter will not flow. The Moho marks the bottom of the porous, spongelike region, about 3 miles below the chamber floor.

Here, SCW acts like a rocket's propellant, escaping with a velocity v_e to the right of the rocket's nozzle (represented by the vertical, yellow line). The "rocket" (shown in silhouette) cannot move to the left, since an identical jetting rocket (because of symmetry) is pushing to the right with an equal force.

For centuries before the flood, the powerful ability of SCW to dissolve certain minerals opened up a myriad of twisting, spaghetti-thin channels throughout the chamber's floor and ceiling. Once the flood began, weeks of steady heating from nuclear reactions in the fluttering crust continuously pressurized the SCW in those miles of long, thin, interconnected channels. That, in turn, greatly elevated the pressure in the subterranean chamber, thereby accelerating the escaping subterranean water even more, not just while it was under the crust but also as it was accelerating upward in the fountains.

Today, SCW is still coming out of what was the porous floor of the subterranean chamber. [See Figures 55 and 56 on pages 124 and 125.] The hot water in the spongelike pockets, which absorbed much of the nuclear energy, also heated the adjacent rock. Today, that heat accounts for much of the *geothermal heat* and increasing temperatures as one descends into deep caves or drills into the Earth. The Moho, explained in Figures 55 and 68 on pages 124 and 133, lies at the base of that global, porous layer, which was about 3-miles thick.

Jet fuel in a high-performance aircraft contains about 20,000 BTU of chemical energy per pound. Greater aircraft speeds might result if the energy content could be increased or the metals containing the hot gases could be strengthened to withstand even higher combustion temperatures and pressures. In comparison, SCW has *many orders of magnitude* more energy per pound, and its container (Earth's thick crust) was much stronger than an aircraft's combustion chamber. Obviously, the exit velocities, expansion rates, and mass of the fountains of the great deep were vastly greater than any jet expelled by an aircraft.

The next time you see contrails in the sky, recognize that escaping, hot, high-pressure gases (primarily water vapor) from a jet aircraft expand downstream so much that they cool, condense and sometimes freeze. The fountains of the great deep experienced much greater expansion and cooling in an environment a few hundred degrees colder than where jet aircraft fly. Recall that billions upon billions of tons of supercold ice crystals suddenly fell from the fountains and buried and froze many mammoths—and much of Alaska and Siberia, and, no doubt, other places (at least temporarily). [See pages 267–299.]

The temperature, T , in an expanding supersonic flow is determined by the Mach number, M , stagnation temperature, T_0 , and the ratio of specific heats, k , which for a perfect gas is about 1.4.¹

$$\frac{T_0}{T} = 1 + \frac{k - 1}{2} M^2$$

The stagnation temperature for the situation in Figure 261 is the temperature in the subterranean chamber. Iron-nickel meteorites exceeded 1,300°F. [See Figure 185 on page 341]. Because meteorites are broken-up rocks launched from the subterranean chamber, T_0 was about 1,300°F. Launch velocities of *at least* 32 miles per second were required to place near-parabolic comets in retrograde orbits.² [See page 317.] If the sonic velocity in the downstream flow was 0.2 miles per second, then

$$T = \frac{1300 + 460}{1 + \left(\frac{1.4 - 1}{2}\right)\left(\frac{32}{0.2}\right)^2} - 460 = -459^\circ F$$

where absolute zero on the Fahrenheit scale is -460°F . Although M , T_0 , and the effective sonic velocity can only be estimated, after the expansion ***the temperature of the flowing gas was so cold, it was almost absolute zero!***

The fountains, unlike a jet aircraft's exhaust, did not collide with and transfer much of their kinetic energy to the atmosphere. Seconds after the rupture, only the thin boundary layer (shown in blue) made contact with the atmosphere. The thinness of that boundary layer must be compared with the great width of the rupture. As explained in Endnote 93 on page 427, the rupture was initially about 6 miles wide, and then, because of erosion and the crumbling walls adjacent to the rupture, grew to hundreds of miles. Most of the heat transferred into that boundary layer would have ended up at the top of the atmosphere—lifted by both natural convection and entrainment.

The fountains split and spread the atmosphere, allowing most of the water and rocks to escape into the vacuum of outer space. Some water within the boundary layer was slowed enough to fall back to Earth as rain or ice. However, rocks carried much more momentum than water droplets, so their trajectories were less deflected by the boundary layers. Therefore, few rocks (and very few larger rocks) fell back to Earth. *Almost all the energy in the rocks and SCW launched from Earth became kinetic energy, not heat.* Much of that energy was electrical (as explained in Endnote 59 on page 144); its release and the acceleration of the fountains probably continued outside the atmosphere.

Notice that the mechanism for accelerating the fountains to hypersonic velocities is not the same as in a standard supersonic jet aircraft or rocket propulsion system. There, a high pressure combustion chamber is upstream of the entire flow, having to push all the fluid downstream through a converging-diverging nozzle. No matter how high the combustion chamber's pressure, its pressure pulses (which only travel at the velocity of sound) cannot outrun the converging flow which, if properly designed, reach the velocity of sound at the nozzle's throat.

However, in the fountains of the great deep, every fluid bundle, throughout the entire column, expanded continuously because of the properties of supercritical

water and its vast energy content. The column's expansion was extreme, because the surrounding pressure dropped, *in seconds*, from the enormous pressure in the subterranean water to almost zero pressure in the vacuum of space.

A closer analogy than that of a standard propulsion system is a bullet traveling down a gun tube. A propellant burns and generates gas *throughout* the expanding gas behind the bullet, steadily accelerating the bullet until it leaves the gun tube. Some pistols, many rifles, and most artillery pieces steadily accelerate their projectiles to supersonic velocities while in relatively short gun tubes. [See "**Paris Gun**," Figure 215 on page 395.] The fountains were in an approximately 60-mile-long "gun tube," not to mention the hundreds-to-thousands of miles of acceleration before and after reaching that "tube." Back pressure from the escaping SCW (like the recoil of a gun or the thrust of a rocket) retarded the flow of SCW trying to escape from the chamber.

At every location on Earth where the visibility of falling rain permitted, the fountains of the great deep would have been seen in the daytime—days and weeks after the rupture—as dark curtains rising above the horizon at two or more locations. At night, those curtains would have glowed from reflected sunlight and internal lightning. The undulations of the fluttering crust must have been even more terrifying.

Once the momentum of the escaping flow from under the crust dropped below a certain threshold, the sagging edge of the plate (fluttering at about one cycle every 30 minutes, as explained on page 606) slammed into the chamber floor for the last time. The flood water above the crust then began falling back into the 60-mile-deep chasm, shutting off the jetting of the fountains. Within minutes "*the floodgates of the sky were closed*," but "*the rain from the sky was restrained*" (Genesis 8:2). Fluttering and jetting ceased, but the rain diminished gradually. By suddenly stopping the jetting fountains, few large rocks fell back to Earth. However, the smaller, less dense water droplets slowed by the boundary layer drifted and fell back through the atmosphere for days. The huge amounts of water that were still trapped under the crust came out slowly and raised the flood waters until they covered all preflood mountains on the 150th day of the flood. [See also "**The Water Prevailed**" on page 491.]

References and Notes

1. This standard derivation assumes one-dimensional flow, a perfect gas, and negligible entropy increase—all fairly reasonable assumptions. See, for example,
 - ❖ Ronald W. Humble et al., *Space Propulsion Analysis and Design* (New York: The McGraw Hill Companies, Inc., 1995), p. 101.
 - ❖ Ascher H. Shapiro, *The Dynamics and Thermodynamics of Compressible Fluid Flow*, Vol. 1 (New York: The Ronald Press Company, 1953), p. 80.
2. One might question whether launch velocities of 32 miles per second were possible. The Paris gun, shown in Figure 215 on page 395, launched 210-pound rounds at one mile per second after accelerating over a distance of only 92 feet. Imagine what nuclear powered accelerations over a 60-mile distance might have achieved. The fluttering crust also produced cyclic water hammers.

How Much Dust and Meteoritic Debris Should the Moon Have If It Is 4,600,000,000 Years Old?

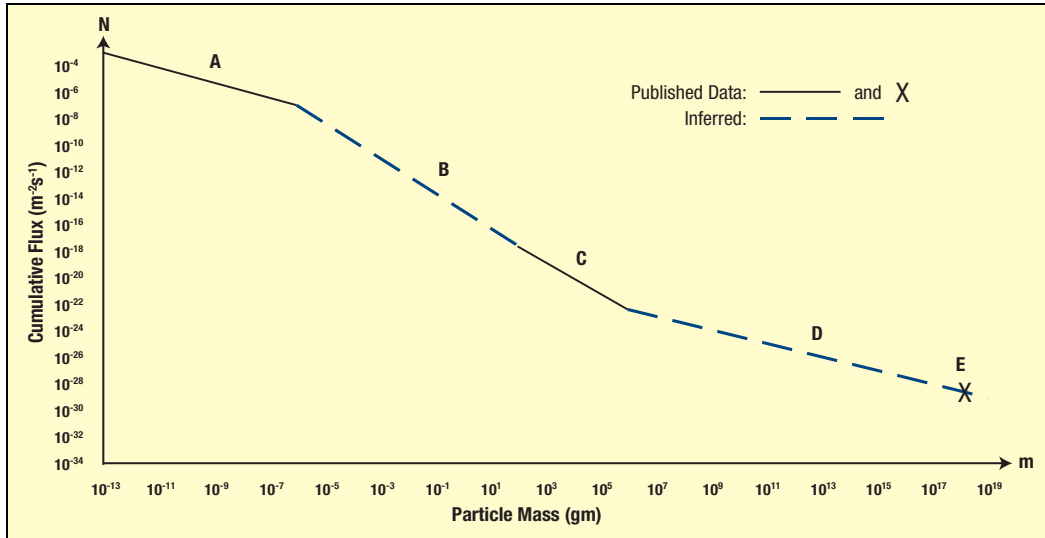

Figure 262: Cumulative Meteoritic Flux vs. Particle Mass.

In 1981, I had a conversation with Dr. Herbert A. Zook of the U.S. National Aeronautics and Space Administration (NASA). He had been intimately involved in estimating the thickness of the dust layer on the Moon before the first Apollo Moon landing. He also helped analyze the lunar material brought back from the Moon. Of the many interesting things he told me and gave me, one is critical in answering the above question.

NASA did not realize until the Moon dust and rocks were analyzed that only one part in 67 (or 1.5%) of the debris on the Moon came from outer space. The rest was pulverized Moon rock. In hindsight, this makes perfect sense. Meteorites striking the Moon travel about 10 times faster than a bullet—averaging 20 km/sec. They are not slowed down by an atmosphere (as on Earth), because the Moon has no atmosphere. Suddenly decelerating a meteorite traveling 20 km/sec to a “dead stop” would compress every atom in it and raise each particle’s temperature to many hundreds of thousands of degrees Celsius. Therefore, each projectile, regardless of size, instantly fragments and vaporizes upon impact, kicking up a cloud of pulverized Moon rocks. Vaporized portions of the meteorite then condense on the pulverized Moon rocks. This was discovered by slicing Moon rocks and finding them coated by meteoritic material—material rich in nickel. Pure Moon rocks have little nickel. In this way, NASA arrived at the factor of 67.¹

The Data

How much meteoritic material is striking the Moon? More specifically, how many particles (N) greater than a certain mass (m) pass through a square meter on the Moon’s surface each second? This is called the cumulative flux.

The data are usually reported on a logarithmic coordinate system as shown in Figure 262, because so many more smaller particles strike the Moon than larger particles.

Particle sizes vary widely. Solar wind blows most particles smaller than 10^{-13} gram out of the solar system. At the other extreme are large crater-forming meteorites. Measurements exist for the influx of meteoritic material in three regions across this broad range. The first will be called Region A; the second will be called Region C; and the last will be called Point E. Regions B and D are interpolated between these known regions and are shown as the blue dashed lines in Figure 262.

Region A is based on impacts registered on a satellite 0.98–1.02 astronomical units from the Sun.² The curve for Region A is

$$\log N_A = -10.08 - 0.55 \log m \quad (10^{-13} < m < 10^{-6} \text{ gm})$$

Seismometers placed on the Moon provided the data for Region C.³ The results, again where N_C is the number of particles per square meter per second that are greater than mass m , were

$$\log N_C = -15.12 - 1.16 \log m \quad (10^2 < m < 10^6 \text{ gm})$$

The equation for Region B is obtained by finding the line that joins the far right point in Region A with the far left point in Region C. That equation is

$$\log N_B = -14.77 - 1.33 \log m \quad (10^{-6} < m < 10^2 \text{ gm})$$

Point E is based on the fact that “there are 125 structures [craters] on the Moon with diameters greater than 100 km.”⁴ The diameter of a large meteorite, impacting at typical velocities, is about 12% of its crater’s diameter. If the density of meteorites is 3 gm/cm³, then the mass of

a meteorite that could form a crater 100 km in diameter would be

$$\frac{4}{3}\pi\left(\frac{0.12 \times 100 \text{ km}}{2}\right)^3 \left(\frac{10^5 \text{ cm}}{\text{km}}\right)^3 \times 3 \frac{\text{gm}}{\text{cm}^3} = 2.71 \times 10^{18} \text{ gm}$$

The Moon's surface area is $3.8 \times 10^{13} \text{ m}^2$. If the largest 125 meteorites struck the Moon during the last 4.6×10^9 years, then the average cumulative flux at Point E is

$$N_E = \frac{125}{4.6 \times 10^9 \times 365.24 \times 24 \times 3600 \text{ sec}} \times \frac{1}{3.8 \times 10^{13} \text{ m}^2}$$

$$= 2.266 \times 10^{-29} \frac{1}{\text{m}^2 \text{ sec}}$$

Point E connects to Region C by the curve

$$\log N_D = -18.91 - 0.53 \log m \quad (10^6 < m < 2.7 \times 10^{18} \text{ gm})$$

The task now is to integrate the total mass of meteoritic material in Regions A, B, C, and D. To do this, we must convert these cumulative flux curves to the thickness of meteoritic material.

Integration

The general form of the cumulative flux curves is

$$\log N = a + b \log m$$

which is equivalent to

$$N = 10^a m^b = \int_m^\infty n \, dm$$

where $n(m)$ is the distribution function of the number of particles of size m .

Differentiating both sides of the right equation above with respect to m gives

$$10^a (b) m^{b-1} = -n$$

Multiplying the number of particles (n) in a narrow mass range (dm) by the mass m and then integrating between m_1 and m_2 gives the total mass within that size range [$m_1 - m_2$] that accumulates per square meter per second.

$$\int_{m_1}^{m_2} n \times m \, dm = 10^a \left(\frac{b}{b+1} \right) (m_1^{b+1} - m_2^{b+1})$$

Within this mass range, the thickness (t) of pulverized meteoritic material that will accumulate on the Moon's surface in 4.6×10^9 years, if the influx has always been at today's rate, is

$$t_{1-2} = 10^a \left(\frac{b}{b+1} \right) (m_1^{b+1} - m_2^{b+1}) k$$

where

$$k = \frac{4.6 \times 10^9 \times 365.24 \times 24 \times 3600 \text{ sec} \left(\frac{\text{m}}{100 \text{ cm}} \right)^3}{2 \frac{\text{gm}}{\text{cm}^3}}$$

and the density of the pulverized lunar crust is 2 gm/cm^3 .

The total thickness of meteoritic material and pulverized Moon rock during 4.6×10^9 years is

$$(t_A + t_B + t_C + t_D) 67$$

where 67 is the ratio of the pulverized Moon rocks to meteoritic material. Table 42 gives the calculated values for the various thicknesses.

Table 42. Computed Thickness of Lunar Dust

Region	a	b	Mass Range (gm)	$67 \times t_{A-D}$ (meters)
A	-10.08	-0.55	10^{-13} to 10^{-6}	0.98
B	-14.77	-1.33	10^{-6} to 10^2	3.17
C	-15.12	-1.16	10^2 to 10^6	0.01
D	-18.91	-0.53	10^6 to 2.71×10^{18}	310.86
Total Thickness =				315.02 m

We will disregard debris contributed by the region to the right of Point E.

Discussion

The lunar surface is composed of a powdery soil, an inch or so thick, below which are 4–10 meters of regolith.⁵ The Moon's regolith consists of a range of particle sizes from fine dust up to blocks several meters wide. Meteoritic impacts overturn and mix this soil-regolith, each time coating the outer surfaces with very thin layers of condensed meteoritic material.

The expected thickness of the soil-regolith, as shown in Table 42, exceeds by about 50 times its actual thickness. (That table assumes that the Moon has been bombarded for 4.6-billion years at only today's rate.) **Most of this calculated thickness comes from Region D**—meteorites larger than 10^6 grams but smaller than meteorites that can form craters 100 km in diameter. Why are the contributions from Regions A, B, and C so much smaller?

We made two incorrect assumptions. First, we assumed that the influx of meteoritic material, for Regions A, B, and C, has always been what it is today. Obviously, the influx decreases over time, because moons and planets sweep meteoritic material up or expel it beyond the Earth-Moon neighborhood. Stated simply, the influx of smaller dust particles in the past was much greater than satellite and moon-based seismometers have detected recently.

Only Point E, which strongly influenced Region D, did not have that assumption. Point E is based on rocks that we know struck the Moon sometime in the past. Removing this assumption *increases the expected thickness in all regions*⁶ and partly explains why Region D contributes so much to our total expected thickness.

Second, Table 42 assumes that the impactors fell steadily from outer space as they do today. However, Figure 175's description on page 311 explains why most large lunar impactors probably originated from Earth and struck the Moon within a few years after the flood began. Heat flow measurements on the Moon are also consistent with a recent cratering event. [See "Hot Moon" on page 42 and the corresponding endnote on page 104.]

What if all lunar impactors were of two types: primary and secondary? The primary impactors were large, extremely *high-velocity* rocks launched from Earth by the fountains of the great deep. Those impacts, perhaps after a few years of orbiting the Sun, formed the Moon's giant, multiringed basins. The resulting debris and other space debris were secondary impactors. Consequently, primary impactors account for Point E, and secondary impactors account for much smaller and slower impactors. Therefore, Region D received less impactor mass than our interpolation assumed.

Conclusion

The relative small amount of debris on the Moon is inconsistent with what we would expect if the solar system

and Moon evolved over 4.6×10^9 years. It appears that two types of impacts have occurred:

- a. a brief and recent interval of very high-velocity impacts by rocks launched from Earth, many of which were large, and
- b. a diminishing number of smaller impacts, distributed today as shown in Regions A–C.

Several individuals have published attempts to answer the question of this technical note. Those efforts have usually (1) neglected the factor of 67, (2) ignored the large impacts shown by Point E, (3) assumed that the influx rate has always been what it is today, and (4) overlooked the relatively recent event that produced meteorites, pummeled the Moon, and provided secondary impactors.

In 2014, rather than measuring the debris falling on the moon, NASA finally processed data that measured the rate at which dust settles on the Moon's surface. Beginning in 1969, small matchbox-sized instruments to measure the rate of influx of Moon dust were sent to the Moon on Apollo 11, 12, 14, and 15. These devices radioed back to Earth every 54 seconds the amount of dust that had collected on them. The conclusion:

*Powdery particles resting on the Moon's surface could form a layer up to 1 millimeter thick every 1,000 years.*⁷

At that rate, after 4.6-billion years (the Moon's age according to evolutionists), the Moon's dust layer would be 2.9-miles thick. This is a conservative estimate, because the influx of dust has undoubtedly been decreasing. Obviously, the Moon has not been collecting dust for 4.6-billion years.

References and Notes

1. This number has also been published.
The content of meteoritic material in mature lunar soils is about 1.5 percent. Stuart Ross Taylor, *Lunar Science: A Post-Apollo View* (New York: Pergamon Press, Inc., 1975), p. 92.
2. David W. Hughes, "Cosmic Dust Influx to the Earth," *Space Research XV*, 1975, pp. 531–539.
- ◆ More recent work has confirmed the cumulative mass flux in the 10^{-9} to 10^{-4} gram size range. [See S. G. Love and D. E. Brownlee, "A Direct Measurement of the Terrestrial Mass Accretion Rate of Cosmic Dust," *Science*, Vol. 262, 22 October 1993, pp. 550–553.]
3. Taylor, p. 92.
4. Ibid., p. 84.
5. Ibid., p. 58.
6. Evolutionists admit that the flux rate has decreased, at least in Region C, by about a factor of 10.
This flux is about one order of magnitude less than the average integrated flux over the past three aeons, calculated on the basis of crater counts on young lunar maria surfaces. Ibid., p. 92.
7. Meghan Rosen, "Moon Dust Gathers Surprisingly Fast," *Science News*, Vol. 185, 11 January, 2014, p. 6.

Did the Preflood Earth Have a 30-Day Lunar Month?

R. Brown, PhD

Then God said, "Let there be lights in the expanse of the heavens to separate the day from the night, and let them be for signs, and for seasons, and for days and years and let them be for lights in the expanse of the heavens to give light on the Earth"; and it was so. And God made the two great lights, the greater light [the Sun] to govern the day, and the lesser light [the Moon] to govern the night; [Genesis 1:14–16a]

And God saw all that He had made, and behold it was very good. [Genesis 1:31]

Today, we have a 29.53-day lunar month.¹ However, many ancient writings indicate that at one time there was a 30-day lunar month. Also, Genesis 7:11, 7:24, and 8:3-4 tell us that exactly 5 months elapsed during the first 150 days of the flood. This suggests that the preflood Earth may have had 30-day lunar months.

Even after the flood, many early calendars still used a 30-day month. Ancient Egyptian astronomers divided the year into three seasons, each with four 30-day months. Later, to achieve the known 365-day year, five days were added at the end of the year.² The Falsi calendar in Asia Minor and India was similar.³ The early Greek and Syrian calendars were similar as well as the calendar established in the 4th century B.C. by Seleucus Nicator, one of Alexander the Great's generals. All of these calendars consisted of 12 months, each with exactly 30 days. Then five days were added to the end of the year to account for the 365-day year, and in some cases a sixth day was added every four years to account for leap year.⁴

Later, Mesopotamia adopted a calendar with 29-day months, which were called "hallow months" along with 30-day months, called "full months."⁵ The Greeks used a similar calendar and also called the 30-day months "full months" and the 29-day months "hallow months."⁶ Perhaps, 30-day months were called "full" and shorter months were "hallow," because they believed at one time all months were 30 days in length.

References in the Vedic and classical Sanskrit texts explain why the length of a year and a month changed. These manuscripts point to a "cosmic upheaval in [the] remote past." They explain that we used to have a 360-day year, but the Earth "underwent a total upheaval," and as a result "the Earth's period of revolution round the Sun in 360 days was changed to 365 days." This also caused the Moon to undergo a "serious perturbation," and "the period of lunation was very probably changed."⁷

Why did so many early cultures prefer a 30-day lunar month, and why do some Vedic and Sanskrit texts refer to a "cosmic upheaval" that altered the length of a year and the lunar month? Perhaps they heard stories passed down from Noah

or one of his descendants. Noah lived for 448 years after the flood, and his son Shem lived for 500 years after the flood. [See Figure 247 on page 504.] The eight people who survived the flood lived a long time. No doubt they told many about the flood and how their lives had changed. They also probably helped establish calendars after the flood. If there was a 30-day month prior to the flood, it is very likely that this was initially the length of a month used after the flood.

As explained on pages 301-377, when the flood began, rocky debris, launched from Earth by the fountains of the great deep later merged to become comets, asteroids, and trans-Neptunian objects (TNOs). Some of that debris would have hit the Moon, primarily on the side nearest the Earth. That would have caused the "serious perturbation" that early Vedic and Sanskrit texts claimed altered "the period of lunation."⁷ There is also physical evidence that debris from the Earth hit the Moon.

The Apollo 17 astronauts discovered that the Moon has an extremely thin atmosphere, about 10^{-14} that of Earth. These gases come from several sources, but the relatively large amount of oxygen was probably launched from Earth during the flood—some from dissociated water vapor that collided with the Moon, and some molecular oxygen dissolved in Earth's surface water, as discovered on comet 67P. [See "Molecular Oxygen" on page 309.] Ice recently discovered on the moon falsifies theories on the Moon's evolution, but is consistent with the hydroplate theory. The Moon is also much warmer than expected. [See "Hot Moon," Endnote 84 on page 104 and Endnote 78 on page 331.] This extra heat is likely due to the recent impacts right after the flood. Finally, the tight clustering of lunar craters and their location on the side of the Moon facing the Earth indicates that the craters were formed by a rapid series of impacts coming from the same direction. Furthermore, these asteroids likely hit the side of the Moon facing Earth at the time. [See Figure 179 and Item 12 on page 319.] All of this physical evidence points to the strong possibility that the Moon was struck from debris recently launched from Earth.

Could these impacts have altered the Moon's orbit, changing it from a 30-day lunar cycle to today's 29.53-day lunar month? Could the Moon have had a perfectly circular (or "very good") orbit, rather than today's slightly elliptical orbit? How much of this debris launched from Earth would have had to impact the Moon to change its orbit to what we see today? These questions are answered in the following calculations that show if only 1.22% of the debris launched from the Earth hit the Moon, the lunar month would have changed from exactly 30 days before the flood to today's 29.53-day lunar month. This percentage was determined by working the entire problem backwards, but it is presented here in chronological order for simplicity. *Surprisingly,*

this would have also changed many of the Moon's other key parameters to what we see today. [See Table 43 on page 592.]

Orbit of the Moon before the Flood

This analysis begins by specifying the initial conditions for the Earth and the Moon before the flood. It is assumed that about 3% of the Earth's mass was expelled by the fountains of the great deep during the flood, and 1.22% of that mass impacted the Moon.⁸ As explained on pages 356–364, the great majority of that expelled mass became TNOs. Therefore, the flood slightly altered the mass of the Earth and Moon. The gravitational parameter, μ , is equal to the gravitational constant, G , times the mass of an object. Subscripts indicate if the parameters are for the Earth (E) or Moon (M) and to designate whether a quantity is before the flood (BF) or after the flood (AF).

$$\mu_{\text{EBF}} = GM_{\text{EBF}} = 410,928.29 \frac{\text{km}^3}{\text{sec}^2} \quad (1)$$

$$\mu_{\text{MBF}} = GM_{\text{MBF}} = 4,752.39 \frac{\text{km}^3}{\text{sec}^2}$$

For small masses, like man-made satellites that orbit the Earth, it is common to ignore the mass of the satellite when calculating orbital parameters, because their mass is so much smaller than the Earth. However, for large bodies, like the Moon, calculations need to account for the mass of the orbiting body. Therefore, the combined gravitational parameter of the Earth and Moon will be used for the analysis here.

$$\mu_{(\text{E+M})\text{BF}} = G(M_{\text{EBF}} + M_{\text{MBF}}) = 415,680.68 \frac{\text{km}^3}{\text{sec}^2} \quad (2)$$

It is also assumed that the Moon's orbit was a perfect circle before the flood, so its eccentricity was zero, and it had a semimajor axis of 395,884 km.

$$e_{\text{MBF}} = 0.00 \quad a_{\text{MBF}} = 395,884 \text{ km} \quad (3)$$

Finally, there were also 360 days in a year before the flood, not today's 365.242 days per year. [See Endnote 35 on page 185.]

Given these initial conditions, the velocity of the Moon's circular orbit and its period before the flood were,

$$V_{\text{MBF}} = \sqrt{\frac{\mu_{(\text{E+M})\text{BF}}}{a_{\text{MBF}}}} = \sqrt{\frac{415,680.68}{395,884}} = 1.0247 \frac{\text{km}}{\text{sec}} \quad (4)$$

$$P_{\text{MBF}} = 2\pi \sqrt{\frac{a_{\text{MBF}}^3}{\mu_{(\text{E+M})\text{BF}}}} = 2\pi \sqrt{\frac{(395,884)^3}{415,680.68}} = 2,427,449 \text{ sec} \quad (5)$$

To convert this period into days, this number must be divided by 86,400, which is the number of seconds in one day. Also, to account for the longer length of a day before the flood, it also needs to be multiplied by the ratio of 360/365.242.

$$P_{\text{MBF}} = 2,427,449 \text{ sec} \left(\frac{1 \text{ day}_{\text{AF}}}{86,400 \text{ sec}} \right) \left(\frac{360 \text{ days}_{\text{BF}}}{365.242 \text{ days}_{\text{AF}}} \right) \quad (6)$$

$$= 27.692 \text{ days}_{\text{BF}}$$

This is called the sidereal period. It is the time required for the Moon to travel 360° around the Earth and arrive at the same point relative to the stars. However, because the Earth moves relative to the Sun, the Moon has to revolve more than 360° around the Earth between successive full Moons (the definition of a synodic period, or lunar month). If there were exactly 12 lunar cycles in a year before the flood, the Earth would have moved 30° each month around the Sun ($\frac{360}{12}$). As a result, the Moon would have had to revolve an extra 30° around the Earth for each lunar cycle. This is illustrated in Figure 263.

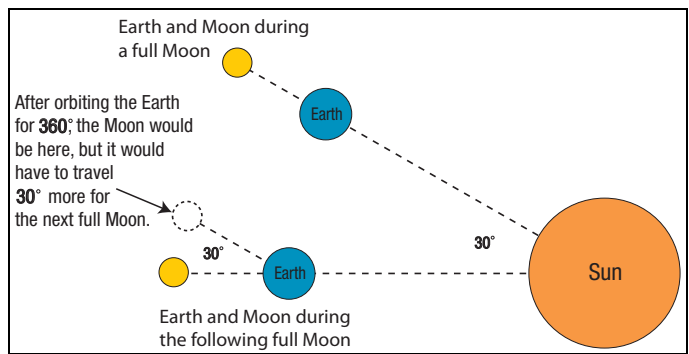

Figure 263: Synodic Period, the Time from Full Moon to Full Moon. Before the flood, a lunar month (or moonth) was 30 days, so the Moon had to revolve around the Earth 30° more than one complete revolution—or 390° total.

Therefore, before the flood, the Moon would have had to revolve 390° around the Earth to make one complete lunar cycle, and the synodic period (SP) would have been

$$SP_{\text{MBF}} = 27.692 \text{ days}_{\text{BF}} \left(\frac{390}{360} \right) = 30.000 \text{ days}_{\text{BF}} \quad (7)$$

which is what people on the Earth would have used to determine the length of a month before the flood.

The Debris As It Was Launched from the Earth

At the time of the flood, about 3% of the Earth's mass was launched into space. Most of that mass would have had enough velocity to escape the Earth's sphere of influence and become comets and asteroids. A very small percentage of this debris (1.22%) hit the Moon. For this analysis it is assumed this mass was launched vertically from the surface of the Earth by the fountains of the great deep, with a velocity of 11.35 km/sec (or 7.05 miles/sec).

In addition to this vertical velocity, the debris would also have had an eastward velocity due to the Earth's rotation. The Earth rotates today 0.4651 km/sec at the equator. Before the flood, it would have been rotating slower,

resulting in 360 days in a year instead of today's 365.242 days. For simplicity, this assumes Earth's radius did not change at the time of the flood.

$$\text{Equatorial Velocity}_{\text{BF}} = 0.4651 \left(\frac{360}{365.242} \right) = 0.4584 \frac{\text{km}}{\text{sec}} \quad (8)$$

This mass would not necessarily have been launched near the equator though. Debris would have been launched from latitudes corresponding to those of today's Mid-Oceanic Ridge. Because the angle between the Moon's orbit and the equatorial plane is 18.28° – 28.58° , the debris that hit the Moon could have come from a narrow range of latitudes: $0^\circ \pm 28.58^\circ$. If the debris came from 28.58° , its eastward velocity would have been

$$\begin{aligned} \text{Velocity at } 28.58^\circ \text{ Latitude} = \\ 0.4584 \cos(28.58^\circ) = 0.4025 \frac{\text{km}}{\text{sec}} \end{aligned} \quad (9)$$

There is no way to know if the debris was launched with a maximum eastward velocity of 0.4584 km/sec, a minimum velocity of 0.4025 km/sec, or some intermediate value. For now, we will assume the maximum velocity of 0.4584 km/sec. Later it will be shown that even if the minimum velocity was used, the final numbers would not change much.

If the debris that impacted the Moon left the Earth from the equator with an eastward velocity of 0.4584 km/sec and a vertical velocity of 11.35 km/sec, it would have had an equatorial orbit. Also, using the Pythagorean Theorem, the magnitude of the debris' velocity would have been 11.35925 km/sec. This is consistent with the estimated average velocity of approximately 11.2 km/sec for asteroids and irregular Moons in Table 44 on page 597.

Using this velocity, along with the gravitational parameter of the Earth before the flood (μ_{EBF}), the specific mechanical energy of the debris was calculated. Here the subscript "D" indicates the debris' orbit. It is assumed the mass that hit the Moon was still affected gravitationally by the other debris from the Earth. This is why the calculations below use the gravitational parameter before the flood, not after the flood.

$$\epsilon_D = \frac{V_D^2}{2} - \frac{\mu_{\text{EBF}}}{R_D} = \frac{(11.35925)^2}{2} - \frac{410,928.29}{6378.137} = 0.08869 \frac{\text{km}^2}{\text{sec}^2} \quad (10)$$

This slightly positive specific mechanical energy indicates the orbit was barely hyperbolic relative to Earth, meaning the debris had just enough energy to escape the Earth's gravitational field (based on the standard definition that potential energy is zero at an infinite distance from Earth). This allowed the semimajor axis of the debris' orbit to be found.

$$a_D = \frac{-\mu_{\text{EBF}}}{2\epsilon_D} = \frac{-410,928.29}{2(0.08869)} = -2,316,655 \text{ km} \quad (11)$$

As expected for a hyperbolic orbit, the semimajor axis is negative.

To calculate the debris' eccentricity, the specific angular momentum had to be found. This is simply the distance the debris is from the center of the Earth times the velocity in the horizontal direction, which in this case is in the eastward direction found in Equation 8.

$$h_D = R \times V_{\text{horizontal}} = 6,378.137(0.4584) = 2,923.7 \frac{\text{km}^2}{\text{sec}} \quad (12)$$

The parameter, p , for the debris' orbit was then found.

$$p_D = \frac{h_D^2}{\mu_{\text{EBF}}} = \frac{(2,923.7)^2}{410,928.29} = 20.805 \text{ km} \quad (13)$$

This parameter of an orbit is also equal to $a(1 - e^2)$, which allows the eccentricity to be found.

$$e_D = \sqrt{1 - \frac{p_D}{a_D}} = \sqrt{1 - \frac{20.804}{-2,316,664}} = 1.000004 \quad (14)$$

As previously mentioned, this is barely a hyperbolic orbit, so the eccentricity should be slightly greater than one.

The Debris When It Arrived at the Moon

It is assumed the debris' orbit can be treated as a two-body problem as it traveled to the Moon, meaning the debris was only affected by the Earth's gravity until it reached the Moon's sphere of influence. Therefore, the specific energy and eccentricity did not change.

Using the value for ϵ_D found in Equation 10, the velocity of the debris was calculated when it arrived at the Moon's distance from the Earth (395,884 km from Equation 3). Notice, Equation 15 is the same as Equation 10; it is just rewritten here to solve for velocity now that energy is known. Also, the subscript "DM" denotes the debris' position, R , and velocity, V , when it arrived at the Moon.

$$V_{\text{DM}} = \sqrt{2 \left(\epsilon_D + \frac{\mu_{\text{EBF}}}{R_{\text{DM}}} \right)} = \quad (15)$$

$$\sqrt{2 \left(0.08869 + \frac{410,928.29}{395,884} \right)} = 1.5011 \frac{\text{km}}{\text{sec}}$$

This is the magnitude of the velocity vector, but its components are needed to determine how the debris affected the Moon's orbit. To find these components, the true anomaly and flight path angle must be calculated first.

True anomaly, ν , is the angle from perigee to the position vector. This is found using the solution to the two-body equation of motion given in Equation 16.

$$R = \frac{p}{1 + e \cos(\nu)} \quad (16)$$

Rewriting this to solve for true anomaly,

$$v_{DM} = \cos^{-1} \left(\frac{\frac{P_D}{R_{DM}} - 1}{e_D} \right) = \cos^{-1} \left(\frac{\frac{20.804}{395.884} - 1}{1.000004} \right) = 179.388^\circ \quad (17)$$

It is now easy to estimate the time it would have taken for the debris to travel to the Moon. The debris was in a slightly hyperbolic orbit ($e = 1.000004$), and it arrived at the Moon's sphere of influence with $v = 179.388^\circ$. The travel time can be accurately estimated as the time required to travel to apogee ($v = 180^\circ$) in an elliptical orbit (e slightly less than 1.0). This can be found by calculating half of the period for an elliptical orbit with a semimajor axis that was half the distance between the Earth and Moon before the flood, or 197,942 km. Using these values, it would have taken five days for the debris to reach the Moon's sphere of influence, and very shortly after that it would have impacted the Moon.

$$\begin{aligned} \text{Time} &= \pi \sqrt{\frac{\left(\frac{a_{MBF}}{2}\right)^3}{\mu_{(E+M)BF}}} = \pi \sqrt{\frac{(197,942)^3}{415,680.68}} \\ &= 429,118 \text{ sec} = 5.0 \text{ days} \end{aligned} \quad (18)$$

The flight path angle, γ , when the debris arrived at the Moon's sphere of influence is found next. This is the angle of the velocity vector above the local horizon as shown in Figure 264. The horizontal component of the velocity vector is $R\dot{v}$, and the vertical, or radial, component of the velocity vector is \dot{R} .

\dot{R} can be found by taking the derivative of the solution to the two-body equation of motion, given in Equation 16. Only true anomaly, v , changes. The parameter, p , and eccentricity, e , would not change. Therefore,

$$\dot{R} = \frac{p\dot{v} e \sin(v)}{[1 + e \cos(v)]^2} \quad (19)$$

Referencing Figure 264, the flight path angle can be calculated using Equations 16 and 19.

$$\begin{aligned} \gamma &= \tan^{-1} \left(\frac{\dot{R}}{R\dot{v}} \right) = \tan^{-1} \left(\frac{\frac{p\dot{v} e \sin(v)}{[1 + e \cos(v)]^2}}{\frac{p}{1 + e \cos(v)} \dot{v}} \right) \\ &= \tan^{-1} \left(\frac{e \sin(v)}{1 + e \cos(v)} \right) \end{aligned} \quad (20)$$

This equation allows the flight path angle to be calculated for the debris when it arrived at the Moon. As found in Equation 14, the eccentricity of the debris' orbit was barely greater than 1.0, and from Equation 17, the true

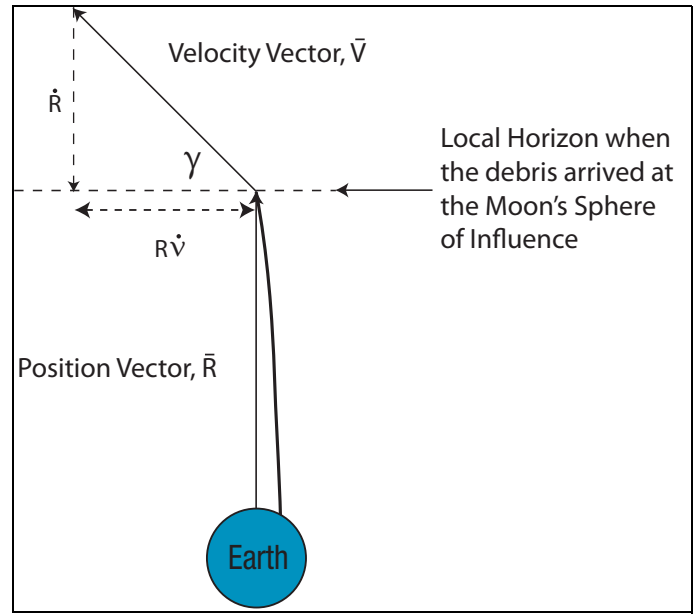

Figure 264: Flight Path Angle, γ , of the Debris When It arrived at the Moon. This figure is drawn looking down at the North Pole.

anomaly of the debris when it reached the Moon's distance from the Earth was 179.388° . Therefore,

$$\begin{aligned} \gamma_{DM} &= \tan^{-1} \left[\frac{e_D \sin(v_{DM})}{1 + e_D \cos(v_{DM})} \right] = \\ \tan^{-1} \left(\frac{1.000004 \sin(179.388^\circ)}{1 + 1.000004 \cos(179.388^\circ)} \right) &= 89.718^\circ \end{aligned} \quad (21)$$

Using this value and the magnitude of the velocity vector, found in Equation 15, the two components of the debris' velocity are found when it was 395,884 km from the Earth (the distance between the Earth and Moon before the flood). Because these calculations assumed the debris was in an equatorial orbit, the horizontal direction was eastward, and there would have been no component of the velocity vector in the northern or southern direction.

$$\begin{aligned} V_D \text{ in Radial Direction} &= V \sin(\gamma) = \\ 1.5011 \sin(89.718^\circ) &= 1.5011 \frac{\text{km}}{\text{sec}} \end{aligned} \quad (22)$$

$$\begin{aligned} V_D \text{ in Easterly Direction} &= V \cos(\gamma) = \\ 1.5011 \cos(89.718^\circ) &= 0.007386 \frac{\text{km}}{\text{sec}} \end{aligned}$$

Changes in the Moon's Orbit

The Moon was also orbiting the Earth at this same distance (395,884 km) with a velocity of 1.0247 km/sec, found in Equation 4. The Moon was assumed to be in a circular orbit, so there was no radial velocity. However, the Moon did not just move eastward. Because the Moon is inclined relative to the Earth's equator between 18.28° and 28.58° ,

its orbit is tipped on average 23.43° relative to the equator (or out of the page if the Moon were shown in Figure 264).¹ Therefore, the Moon would have been moving eastward with a velocity of 0.9402 km/sec on average.

$$V_{\text{MBF Eastward}} = 1.0247 \cos(23.43^\circ) = 0.9402 \frac{\text{km}}{\text{sec}} \quad (23)$$

Due to its inclination, the Moon would also have had an average velocity component in the northern or southern direction equal to $1.0247 \sin(23.43^\circ) = 0.4074$ km/sec as it crossed the equator.

Comparing Equations 22 and 23, notice the Moon would have been moving much faster eastwardly than the debris ($0.9402 > 0.007386$). This means the Moon would have run into the debris, similar to what would happen if a few boulders were softly tossed in front of a fast moving car. These extremely large rocks reduced the Moon's energy, which would have dropped the Moon into a lower orbit and decreased its period. It is relatively easy to calculate exactly how the Moon's velocity would have been changed by the debris. Once the debris entered the Moon's Sphere of Influence (SOI), it is fair to assume that only the Moon affected the debris' orbit. Also, because gravity is a conservative force, it is not necessary to determine the exact orbit of the debris inside the Moon's SOI. All that is needed is to compare the total momentum of the debris and Moon immediately before the debris entered the Moon's SOI and set this equal to the momentum of the Moon after impact.

Instead of using momentum as the product of mass and velocity (mV), these calculations use μV , which is more convenient and slightly more accurate. (Remember μ is the gravitational constant, G , times the mass of a body.) The following calculations also use the assumptions listed previously that 3% of the Earth's mass was lost at the time of the flood, and 1.22% of this mass impacted the Moon. Therefore,

$$\mu_D = 1.22\%(3\%)(410,928.29) = 150.4 \frac{\text{km}^3}{\text{sec}^2} \quad (24)$$

Also, using μ from Equation 1, the gravitational parameter of the slightly heavier Moon after impact would be

$$\mu_{\text{MAF}} = 4,752.4 + 150.4 = 4902.8 \frac{\text{km}^3}{\text{sec}^2} \quad (25)$$

Using these values for μ , the velocity of the Moon after the flood was found in Equation 26 to be 0.04605 km/sec in the radial direction.

$$\begin{aligned} \mu_{\text{MBF}} V_{\text{M Radially}} + \mu_D V_{\text{D Radially}} &= (\mu_{\text{MAF}}) V_{\text{MAF Radially}} \\ 4,752.4(0) + 150.4(1.5011) &= (4902.8) V_{\text{MAF Radially}} \end{aligned} \quad (26)$$

$$V_{\text{MAF Radially}} = 0.04605 \frac{\text{km}}{\text{sec}}$$

In the eastern direction the Moon would have been moving 0.91158 km/sec after impact.

$$\begin{aligned} \mu_{\text{MBF}} V_{\text{M Eastward}} + \mu_D V_{\text{D Eastward}} &= \mu_{\text{MAF}} V_{\text{MAF Eastward}} \\ 4,752.4(0.9402) + 150.4(0.007386) &= (4902.8) V_{\text{MAF Eastward}} \end{aligned} \quad (27)$$

$$V_{\text{MAF Eastward}} = 0.91158 \text{ km/sec}$$

The Moon would also have been moving in the northern (or southern) direction 0.39503 km/sec after impact.

$$\begin{aligned} \mu_{\text{MBF}} V_{\text{M Northward}} + \mu_D V_{\text{D Northward}} &= \mu_{\text{MAF}} V_{\text{MAF Northward}} \\ 4,752.4(0.4075) + 150.4(0) &= 4902.8 V_{\text{MAF Northward}} \end{aligned} \quad (28)$$

$$V_{\text{MAF Northward}} = 0.39503 \frac{\text{km}}{\text{sec}}$$

Using the Pythagorean Theorem, the magnitude of the Moon's velocity after impact was calculated from these three components to be 0.99454 km/sec.

To summarize, three things changed for the Earth and Moon at the time of the flood that affected the Moon's orbit:

1. The Earth lost 3% of its mass, so

$$\mu_{\text{EAF}} = 97\%(410,928.29) = 398,600.4 \frac{\text{km}^3}{\text{sec}^2} \quad (29)$$

2. The Moon's mass changed very slightly when 1.22% of the mass ejected from the Earth hit the Moon. As calculated in Equation 25, $\mu_{\text{MAF}} = 4902.8$ km/sec.

3. The Moon's velocity changed as found in Equations 26 through 28.

As mentioned previously, when calculating the orbit for large objects like the Moon, the gravitational parameters of the two bodies need to be combined. Therefore,

$$\mu_{(\text{E+M})\text{AF}} = \mu_{\text{EAF}} + \mu_{\text{MAF}} = 398,600.4 + 4902.8 = 403,503.2 \frac{\text{km}^3}{\text{sec}^2} \quad (30)$$

The steps to calculate the semimajor axis and eccentricity of the Moon after the flood follow the exact same process outlined in Equations 10 through 14. First, knowing the new velocity of the Moon, and assuming its position did not change immediately ($R = 395,884$ km from Equation 3), the Moon's specific mechanical energy after the flood would be

$$\epsilon_{\text{MAF}} = \frac{V_{\text{MAF}}^2}{2} - \frac{\mu_{(\text{E+M})\text{AF}}}{R_{\text{MAF}}} = \frac{(0.99454)^2}{2} - \frac{403,503.2}{395,884} = -0.52469 \frac{\text{km}^2}{\text{sec}^2} \quad (31)$$

This allows the semimajor axis of the Moon after the flood to be found.

$$a_{\text{MAF}} = \frac{-\mu_{(\text{E+M})\text{AF}}}{2\epsilon_{\text{MAF}}} = \frac{-403,503.2}{2(-0.52439)} = 384,514 \text{ km} \quad (32)$$

The specific angular momentum of the Moon after the flood is simply the distance the Moon was from the center of the Earth times the velocity in the horizontal direction. In this case, the horizontal velocity of the Moon had an eastwardly and northerly (or southerly) component found

in Equations 27 and 28. Using the Pythagorean Theorem, the total horizontal velocity was found.

$$h_{MAF} = R_{MAF} \times V_{horizontal} = \quad (33)$$

$$395,884 \sqrt{0.91156^2 + 0.39503^2} = 393,300 \frac{\text{km}^2}{\text{sec}}$$

The parameter, p , for the Moon's orbit after the flood was then found.

$$P_{MAF} = \frac{h_{MAF}^2}{\mu_{(E+M)AF}} = \frac{(393,300)^2}{403,503.2} = 383,354 \text{ km} \quad (34)$$

Because $p = a(1 - e^2)$, the eccentricity of the Moon's orbit after the flood was

$$e_{MAF} = \sqrt{1 - \frac{P_{MAF}}{a_{MAF}}} = \sqrt{1 - \frac{383,354}{384,514}} = 0.05492 \quad (35)$$

From these values the Moon's radius of perigee, R_p , and radius of apogee, R_A , after the flood were calculated.

$$R_{P\ MAF} = a_{MAF}(1 - e_{MAF}) = 384,514(1 - 0.05492) = 363,396 \text{ km} \quad (36)$$

$$R_{A\ MAF} = a_{MAF}(1 + e_{MAF}) = 384,514(1 + 0.05492) = 405,632 \text{ km}$$

Also, the Moon's sidereal period can be found.

$$P_{MAF} = 2\pi \sqrt{\frac{a_{MAF}^3}{\mu_{(E+M)AF}}} = 2\pi \sqrt{\frac{(384,514)^3}{403,503.2}} = 2,358,438 \text{ sec} = 27.297 \text{ days}_{AF} \quad (37)$$

As explained previously, this is the time for the Moon to travel 360° around the Earth. However, the Moon must travel slightly farther between successive full Moons. Prior to the flood, the Moon had to move an extra 30° for each lunar cycle. [See Figure 263.] Because the length of a lunar month today is 29.53 days, and the length of a year is 365.242 days, the Moon must now move an extra 29.106° ($\frac{29.53}{365.242} \times 360^\circ$) today. Therefore, the Moon's synodic period after the flood should be

$$SP_{MAF} = 27.297 \text{ days}_{AF} \left(\frac{360 + 29.106}{360} \right) = 29.504 \text{ days}_{AF} \quad (38)$$

It is actually 29.53 days, which means these calculations are off by only 0.026 days or 37 minutes, with a percent error of only 0.09%. Six other parameters describing the Moon's orbit around the Earth are even closer to the actual values. All seven of these numbers are summarized in Table 43.

Validity of Assumptions

Now that the calculations are complete, before making any conclusions, it is appropriate to look at the validity of the assumptions made, and see how sensitive the final answers were to the four most significant assumptions. Those assumptions were:

1. The debris that hit the Moon was launched from the Earth's equator.
2. The debris left the Earth with a vertical velocity of 11.35 km/sec.

3. The Earth lost 3% of its mass during the flood.
4. 1.22% of the mass ejected from the Earth hit the Moon.

First, let's look at Equation 8, where we assumed the debris that impacted the Moon came from the equator and had an eastward velocity of 0.4584 km/sec. The debris could have come as far north (or south) as 28.58° latitude and still hit the moon. If the calculations above were repeated assuming the debris was launched from the maximum latitude of 28.58° as shown in Equation 9, the debris would have the slowest possible eastward velocity of 0.4026 km/sec when it left Earth. In this case the debris would have also been in an inclined orbit, and the final numbers would be almost exactly the same even if no other numbers were changed. For example, the synodic period of the Moon after the flood would be 29.501 days, instead of 29.504 days (found in Equation 38). So this assumption had no real impact on the final results.

It was also assumed the debris that impacted the Moon was launched from the Earth with a vertical velocity of 11.35 km/sec. To measure the sensitivity to this assumption, the calculations outlined here were duplicated with many other vertical launch velocities. Without changing any other numbers, as long as the velocity was between 11.26 km/sec (the minimum velocity sufficient to reach the Moon) and 11.88 km/sec, the Moon's orbit always became more eccentric, and the lunar month was also shorter than before the flood. Both changes are consistent with what we see today. Also, velocities in this range from 11.26 to 11.88 km/sec are consistent with the values estimated in Table 44 on page 597. So, this assumption was reasonable, and the final results were not affected significantly by slight changes in the estimated velocity.

It was also assumed that the Earth lost about 3% of its mass at the time of the flood. This is the average of two different studies that estimated the mass of all TNOs. One study estimated that the mass of all TNOs is 2% of Earth's mass, and the other study, using a different technique, arrived at 4%. [See Endnote 148 on page 375 and pages 356–364.]

As stated earlier, it is also assumed that 1.22% of this mass impacted the Moon. This is slightly more than the 0.7% that we would expect to hit the Moon if the debris was evenly distributed in all directions from Earth.⁹ However, there is no reason to believe the debris was evenly distributed; it probably was more concentrated near the pre-flood equator.

Conclusions

Many ancient writings suggest there was once a 30-day lunar month, and there are physical characteristics on the Moon that indicate the asteroids or comets that hit the Moon came from the Earth. If the Moon had a circular orbit and a 30-day synodic period before the flood and only 1.22% of the mass ejected from the Earth during the flood hit the Moon, it would have altered the Moon's orbit to what we see today. In fact, the calculated parameters of the Earth and

Table 43. Comparison of Calculated Parameters and Actual Parameters for the Moon Today

Parameter	Equation	Calculated Value	Actual Value	Error	Percent Error
Earth's Gravitational Parameter (km ³ /sec ²)	29	398600.4	398600.4	0.0	0.00%
Moon's Gravitational Parameter (km ³ /sec ²)	25	4902.8	4902.8	0.0	0.00%
Moon's Semimajor Axis (km)	32	384,514	384,400	114	0.03%
Moon's Radius of Perigee (km)	36	363,396	363,300	96	0.04%
Moon's Radius of Apogee (km)	36	405,632	405,500	132	0.03%
Moon's Eccentricity	35	0.05492	0.05490	0.00002	0.04%
Moon's Synodic Period (days)	38	29.504	29.53	-0.0260	-0.09%

Moon after the flood are all very close to the known values today. Table 43 compares seven of these calculated parameters with the actual values. Notice, the calculated values are only off by a fraction of a percent. On average, the absolute values of percent errors listed in Table 43 are only 0.031%!

At the end of the creation week, “God saw all that He had made, and behold, it was very good.” [Genesis 1:31] Although we are unable to truly appreciate how “very good” the original creation was, we now can better imagine how “very good” the preflood system was for measuring time.

The Lunar Cataclysm—Late Heavy Bombardment (LHB)

The Apollo astronauts brought lunar rocks back to Earth showing that the Moon had been heavily bombarded long after the Moon had formed—an event called “*The Late Heavy Bombardment*.” Planetary and Earth scientists then jumped to the conclusion that asteroids did the bombarding. Problems with this theory are now being discussed:¹⁰

- a. If a swarm of asteroids pummeled the Moon, Earth, with its larger size and gravity, would have experienced even more hits—enough to “vaporize most of Earth’s water,”¹¹ making our atmosphere a scalding-hot, runaway greenhouse. How then could life have survived on Earth—or arisen?
- b. Where were all these asteroids hiding before the

LHB? If they came from the asteroid belt, home of 90% of all asteroids, how could they have left the asteroid belt? How could they have converged on the Moon—all at about the same time?

- c. Why doesn’t Earth have more craters? Did plate tectonics recycle Earth’s crust over billions of years?

Multi-billion-dollar plans to return to the Moon to try to answer these questions are no longer necessary. As explained on pages 586–592, when the flood began, the Moon was bombarded by a flurry of rocks launched from Earth by the powerful fountains of the great deep. A year later, thick flood-deposited sediments blanketed Earth’s impact craters.

References and Notes

1. “Moon Fact Sheet,” NASA. <http://nssdc.gsfc.nasa.gov/planetary/factsheet/moonfact.html>.
2. R. A. Parker, “Ancient Egyptian Astronomy,” *Philosophical Transactions of the Royal Society of London. Series A, Mathematical and Physical Sciences*, Vol. 276, No. 1257, 2 May 1974, p. 51.
- ◆ Early Egyptians assumed a 360-day year, until they realized that the Nile was flooding later and later each year according to that calendar. Because Egypt’s earliest settlers probably would not have adopted a 360-day year while in Egypt, they presumably brought that outdated understanding with them. [See J. Norman Lockyer, *The Dawn of Astronomy* (Cambridge, Massachusetts: The M.I.T. Press, 1964), pp. 243–248.]
3. Frank Parise, *The Book of Calendars* (Gorgias Press LLC).
4. *Ibid.*, p. 44.
5. Wayne Horowitz, “The 360 and 364 Day Year in Ancient Mesopotamia,” *Journal of the Ancient Near Eastern Society*, Vol. 24, 1996, p. 36.
6. T. Freeth et al., “Decoding the Ancient Greek Astronomical Calculator Known as the Antikythera Mechanism,” *Nature*, Vol. 444, 30 November 2006, pp. 587–591.
7. Dileep Kumar Kanjilal, “The Origin of the Concept of the Intercalary Month (Malamâsa) in India,” *Annals of the Bhandarkar Oriental Research Institute*, Vol. 77, No. 1/4 (1996) p. 259.
8. For the purposes of this study, these percentages could be varied slightly and the two assumptions could be replaced by one assumption; namely, that 0.036% ($0.03 \times 1.22\% = 0.036\%$) of the preflood Earth’s mass hit the Moon.
9. The cross section of the Moon’s sphere of influence (SOI), whose radius is 66,100 km, is $4\pi(66,100)^2$. This is 0.7% of $4\pi(395,844)^2$ —the surface area of a sphere with a radius from the Earth to the Moon.
10. “Cataclysm’s End: A Popular Theory about the Early Solar System Comes under Fire,” *Nature*, Vol. 553, 25 January 2018, pp. 393–395.
11. *Ibid.* p. 393.

Does Subduction Really Occur?

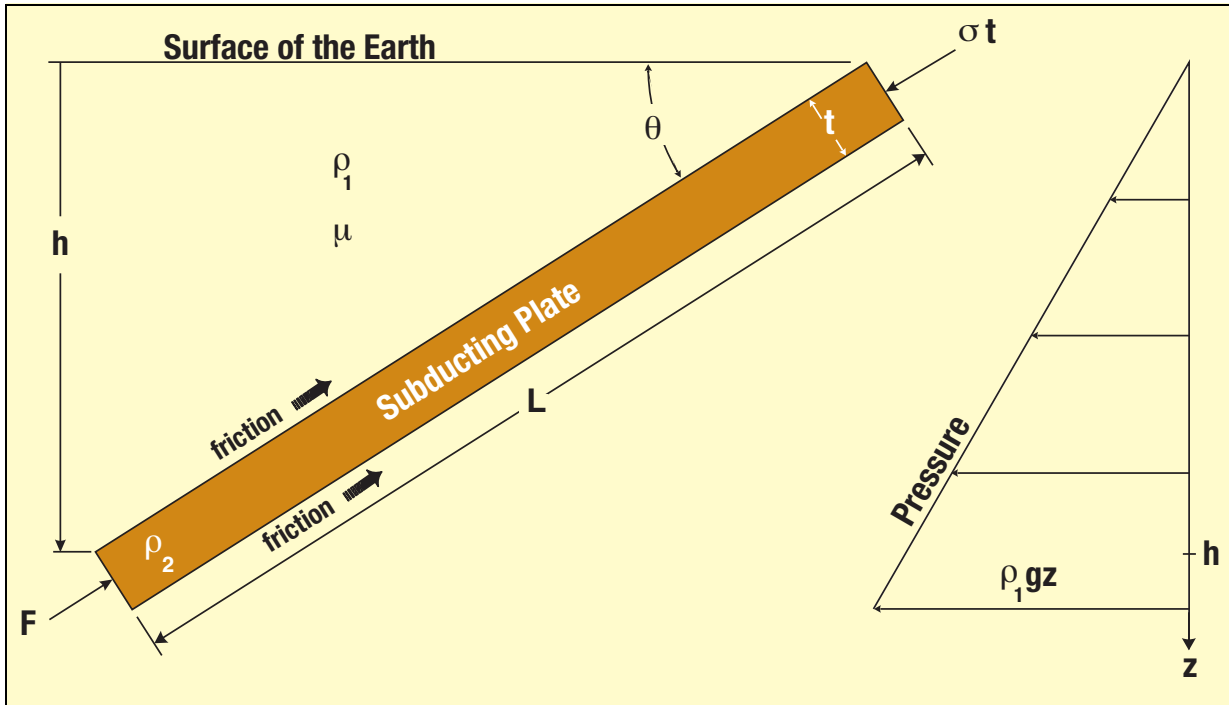

Figure 265: A Plate Trying to Subduct.

A plate, which may or may not be subducting, has a length L , thickness t , density ρ_2 , and a unit depth. It is inclined at an angle θ below the horizontal and is pushed by a compressive stress σ through rock whose density is ρ_1 . Solid-to-solid friction, with a coefficient of μ , acts to a depth h on both the top and bottom of the plate. The lithostatic pressure at a depth z is the mean density ρ_1 times z times the acceleration due to gravity g . A drag force F opposes movement at the leading—and very blunt—edge of the plate.

To make subduction as likely as possible, we must assume that:

- ◆ The thrusting force, σt , is perfectly aligned with the subduction angle θ .
- ◆ The thrusting force is the maximum possible, but does not exceed the crushing strength of the subducting plate.
- ◆ The plate is denser than the mantle surrounding it. (*Without this assumption, the plate would not sink. Actually, the mantle, through which the plate must push, is much denser than the plate.*)

For the plate to subduct, the sum of the forces down and to the left must exceed the sum of the forces up and to the right. That is:

$$\begin{aligned} \{\text{Net Thrust}\} + \{\text{Body Forces}\} &> \{\text{Friction on Top and Bottom Surfaces}\} \\ (\sigma t - F) + g(\rho_2 - \rho_1)Lt \sin\theta &> \left(\rho_1 g \frac{h}{2} L\mu\right) + \left(\rho_1 g \frac{h}{2} + \rho_2 g t \cos\theta\right)L\mu \end{aligned}$$

In dimensionless form, this simplifies to

$$\frac{\left(\frac{\sigma - F}{t}\right)}{\rho_1 g L \sin\theta} + \left(\frac{\rho_2 - 1}{\rho_1}\right) > \left(\frac{L}{t} + \frac{\rho_2}{\rho_1} \cot\theta\right)\mu$$

The coefficient of static friction for rock against rock is about 0.6 and is largely independent of mineralogical composition and temperature up to about 350°C. Typical values for the above inequality are shown below.

$$\begin{aligned} \sigma &= 2 \times 10^9 \frac{\text{dynes}}{\text{cm}^2} & g &= 980 \frac{\text{cm}}{\text{sec}^2} \\ \rho_1 &= 3.2 \frac{\text{gm}}{\text{cm}^3} & \rho_2 &= 3.5 \frac{\text{gm}}{\text{cm}^3} \\ L &= 160 \text{ km} & t &= 80 \text{ km} \\ \theta &= 30^\circ & \mu &= 0.6 \end{aligned}$$

To make subduction much more likely, let's assume that $F = 0$. Substituting these values in the above inequality gives the *false* statement that

$$0.04 + 0.09 > (2.000 + 1.894) 0.6$$

Because *the inequality cannot be satisfied, a pushing force will not cause subduction*. Remember, we made the very generous assumption that $F=0$. In other words, the blunt end of a plate 30–60-miles thick, and hundreds of miles wide, experiences no resistance as it is pushed through the Earth's rock crust. (Even if the coefficient of friction were only 0.031, one-nineteenth of the above value and $F=0$, subduction could still not occur!)

Some believe that a pulling force causes subduction. They say, for example: “at a given depth, the subducting plate is colder, and therefore denser, than the mantle. The plate sinks through the mantle, like a dense rock falling through mud. As it falls, it pulls the rest of the plate.”

This proposal overlooks the weak tensile strength of rock. If the pushing force, described above, cannot cause subduction, a much weaker pulling force certainly will not. ***Therefore, subduction will not occur.***

How Much Water Was in the Preflood Subterranean Chamber?

Today, the water from the preflood subterranean chamber is in three places: (1) in Earth's biosphere, primarily our oceans, (2) in outer space, and (3) still trapped deep under the Earth's surface.

Salt (NaCl). Before the flood, the subterranean water contained most of Earth's salt. Russia and Germany have drilled the deepest holes on Earth, 7.6 miles and 5.7 miles, respectively; each contained deep salt water. The German hole contained twice the ocean's salt concentration. [See page 118.] Surface water cannot seep deeper than 5 miles, so that water must have migrated up from the subterranean chamber—through the sponge-like pockets formed when supercritical water dissolved certain minerals in the chamber's ceiling. Therefore, about half the water in our oceans came from the subterranean chamber. Of course, this is based on a number of assumptions, such as the preflood surface water contained little salt, and the concentration of salt in the German drill hole represents the salt concentration that was in the chamber.

Deuterium (Heavy Hydrogen). As explained in the chapter on “The origin of Earth's radioactivity” (pages 379–433), the subterranean chamber was also the source of the deuterium in our oceans and in comets. Comets contain about twice the concentration of deuterium as our oceans; so again, it looks as if half the water in the oceans came from the subterranean chamber. [See “Heavy Hydrogen” on page 310.] Also, without a huge source of free neutrons, we can assume there was little deuterium in the preflood seas.

This does not mean that the subterranean chamber held only half of the $1.43 \times 10^9 \text{ km}^3$ of water that is in our oceans, because an unknown amount of subterranean water was expelled into space, and no one knows how much water is still below the Earth's surface—trapped between the former chamber's ceiling and floor and in the sponge-like pockets in the chamber's ceiling and floor. Even today, some of that water is entering the oceans as black smokers—jetting up from the sponge-like pockets in the former chamber floor. [See Figure 56 on page 125.]

Therefore, a *lower bound* of 0.9 miles could be placed on the average thickness of the subterranean chamber if we took half of today's ocean volume and spread it over the chamber's horizontal area, which was roughly the surface area of today's Earth ($5.1 \times 10^8 \text{ km}^2$).

$$\frac{0.5 \times 1.43 \times 10^9 \text{ km}^3}{5.1 \times 10^8 \text{ km}^2} \times \frac{\text{mile}}{1.609 \text{ km}} = 0.9 \text{ miles}$$

However, for simplicity, we will say that it was *at least* 1 mile thick. It could have been much thicker when one considers (1) how much preflood subterranean salt water could still be trapped far below the Earth's surface, and (2) how much subterranean water was launched into space. A quick glance at the total mass in Table 44 on page 597 shows that much of that mass could have been water from the subterranean chamber. Many minor factors and complexities need not concern us, because they are dwarfed by both of the above uncertainties.

Tidal Pumping: Two Types

The water layer under Earth's pre-flood crust largely *decoupled* it from the mantle. That gave the crust (a spherical shell), much greater flexibility than if it had been anchored and bonded over the entire mantle's surface as it is today. Therefore, almost no shearing stresses acted on the base of the crust, allowing it to flex more easily from a sphere to an ellipsoid (and back again) during each tidal cycle. Also, as the Moon's gravity lifted the crust at 12 o'clock, the crust was depressed (pinched in) at 9 o'clock and 3 o'clock. So the confined subterranean water was always squeezed (pumped) *by increasing pressure* from low to high tide, thereby providing additional lift to the crust at 12 o'clock. Today, Earth's crust is tightly anchored to the mantle, so only small ocean tides are produced.

The pillars were also compressed and stretched twice a day by a second form of tidal pumping. The Moon's gravity lifted some of the weight of the crust off the pillars at 12 o'clock and partially lifted the inner Earth off the compressed pillar at 6 o'clock. This, in turn, compressed the pillars at 9 o'clock and 3 o'clock. Today, even without a decoupling layer of subterranean water, the Global Positioning System can measure *solid tides*¹ on Earth up to 40 centimeters (1.31 feet).² At mid-latitudes, solid tides have amplitudes of about a foot,³ but with a decoupling layer of water, the crust's pre-flood deflections would have been much greater than 40 centimeters, so the repeatedly compressed and hammered pillars would have produced enormous amounts of heat.⁴

Some energy expended in compressing pillars was recovered elastically during the expansion half-cycle. However, a fraction of that energy was dissipated as heat and would have maintained the subterranean water's supercritical temperature that was established as the foundation of the Earth's crust was established during the creation week. [See [Figure 240 on page 476](#).]

Mention has frequently been made in this book about how the supercritical water steadily dissolved certain minerals in the granite crust, such as quartz crystals which constituted about 27% of the granite by volume. At some point the increasing loss of heat by the water rising by natural convection through the porous lower crust and evaporating Earth's ground water equaled the heat generated by tidal pumping. At that point, steady state was reached and temperatures and pressures did not change. [See "[Tidal Pumping](#)" on page [471](#).]

Two moons in the solar system, Saturn's Enceladus and Jupiter's Europa, are unusual, because they emit so much heat—far more heat than can be explained by radioactive decay.⁵ Enceladus' heat produces a jet of water plasma that the orbiting Cassini spacecraft passed through and measured several times. [See [Figure 189 on page 346](#).] A layer of water under the crusts of both moons explains

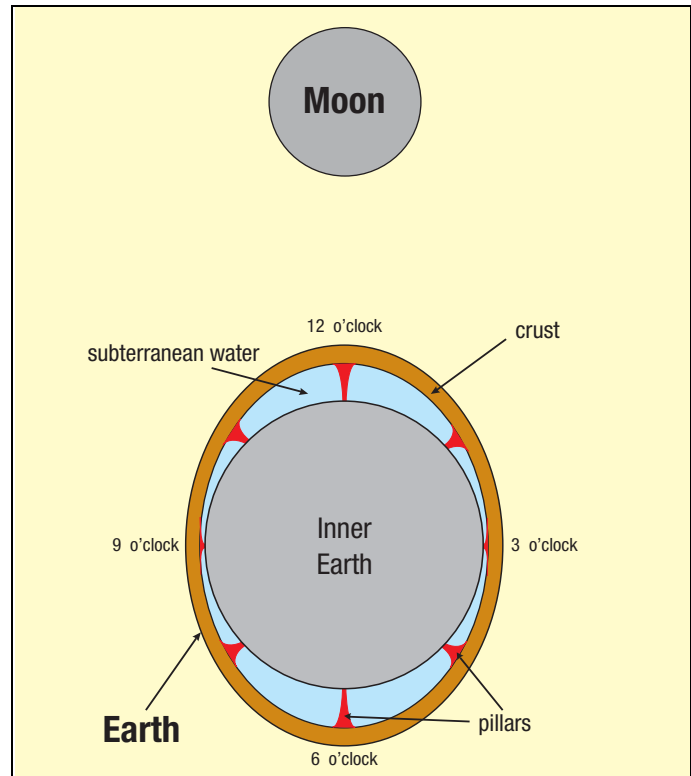

Figure 266: Tidal Pinch. (Not to scale.) When considering tidal pumping, think of the Earth rotating under the Moon almost once a day, rather than the Moon orbiting the Earth about every 30 days. Before the flood, the Moon's gravity not only lifted the largely decoupled (and, therefore, relatively flexible) crust at 12 o'clock and 6 o'clock, it pinched the crust inward at 9 o'clock and 3 o'clock. Both actions pumped the confined subterranean water toward high tide. Twice a day for centuries, tidal pumping also generated immense amounts of heat as the massive crust compressed the pillars near 9 o'clock and 3 o'clock and stretched those near 12 o'clock and 6 o'clock. These pillars were portions of the sagging crust that touched the chamber floor, not tall cylindrical pillars as used today in buildings. [See pages 469–475.]

On page 523, the Hebrew word *raqia*, which means a hammered-out or pressed-out solid, was identified as the Earth's crust. Pillars were the thousands of contacts where the sagging crust pressed against the chamber floor and generated gigantic amounts of heat by cyclic compression twice a day. That heat engine drove the watering system for the pre-flood Earth, as explained in "[Tidal Pumping](#)" on page 471. Therefore, *raqia*—a pressed out solid—seems an apt, descriptive word for the crust.

the great heat produced.^{6,7} Other evidence also supports the presence of those layers of liquid water.⁸ [See page 346.]

Heat on Enceladus and Europa is generated by the flexing of their floating ice crusts. Because Earth's pre-flood crust was composed of granite, not floating ice, pillars were present. [For details on why, how, and when pillars formed, see pages 469–475.] Therefore, the second form of tidal pumping acted continuously on pillars before the flood and produced much more heat than that produced elsewhere in the deflecting crust.

By understanding how tidal pumping produced supercritical water (SCW), perplexing questions can now be answered, including:

- ◆ the source of the SCW that has been discovered still jetting up in black smokers on the ocean floor,
- ◆ the origin and nature of the Moho,
- ◆ the origin of vast salt, limestone, and dolomite deposits,
- ◆ the source of the cementing agents that hold sedimentary rocks together, and
- ◆ the origin of most ore bodies.

For a few details, see pages 121–127.

Without knowing that SCW was present before the flood or how SCW was produced, these rarely addressed topics would continue to seldom be discussed, and the gigantic energy released by all the fountains of the great deep would not be understood.

References and Notes

1. If the Earth had no water and was a perfectly spherical rock, the gravity of the Moon, and to a lesser extent the Sun, would deform the sphere slightly. That deformation is called the “solid tide.” For example, twice a day, the solid tide lifts and lowers the foundation of your home slightly, *relative to the center of the Earth*.
2. “... the solid Earth tide can account for displacements up to ~0.4 m [1.31 feet]” C. Watson et al., “The Impact of Solid Earth Tide Models on GPS Coordinate and Tropospheric Time Series,” *Geophysical Research Letters*, Vol. 33, 22 April 2006, p. L08306-1.
3. “Tidal effects could reach up to 30 cm [0.98 feet] in Denmark and Greenland ...” Guochang Xu and Per Knudsen, “Earth Tide Effects on Kinematic/Static GPS Positioning in Denmark and Greenland,” *Physics and Chemistry of the Earth (Part A: Solid Earth and Geodesy)*, Vol. 25, 2000, p. 409.
4. An additional amount of heat would have been generated in each pillar’s expansion half-cycle. For simplicity, and to be conservative, this heat will be neglected.

Alternatively, the heat generated during a complete compression-expansion cycle would equal the mechanical hysteresis losses, sometimes called *the tidal dissipation*. If the pillars were purely elastic (or could be considered as a perfect spring), the hysteresis losses would be zero. Because granite is partially elastic, the hysteresis losses must be experimentally determined for the particular (but unfortunately unknown) geometry of the granite pillars. For rocks at tidal frequencies, tidal dissipations of 50% are often used.

Once the flood began, that energy would have been converted to kinetic energy, because the SCW would have expanded enormously (and cooled) as it flowed in the direction of decreasing pressures, toward the base of the fountains and then up into the fountains. (As explained in “Three Common Questions” on page 126, a remarkable characteristic of supercritical fluids is that a small decrease in pressure produces a gigantic increase in volume—and cooling.
5. “The question arises as to the present state of the H₂O mantle [on Europa]—is it primarily [liquid] water or ice? Calculations of the transport of heat by subsolidus convection in ice indicate that it would be completely frozen if normal solar system abundances of radioactive elements were the only heat sources present.” P. Cassen et al., “Is There Liquid Water on Europa?” *Geophysical Research Letters*, Vol. 6, September 1979, p. 731.

◆ “... radiogenic heating alone cannot explain the huge heat power observed at the south pole [of Enceladus].” G. Tobie et al., “Solid Tidal Friction above a Liquid Water Reservoir as the Origin of the South Pole Hotspot on Enceladus,” *Icarus*, Vol. 196, August 2008, p. 642.
6. “The heating rate in the ice crust is greater than in a completely solid body because the unsupported crust is subject to greater deformation.” P. Cassen et al., p. 731.

◆ “...only interior models with a liquid water layer at depth can explain the observed magnitude of dissipation rate and its particular location at the south pole.” G. Tobie et al., p. 642.

◆ “... when a globally decoupling liquid layer is included, the total dissipation power is strongly enhanced and it reproduces the observed [heat flow].” *Ibid.*, p. 644.

◆ “... models with no internal liquid layer cannot generate a hotspot at the south pole.” *Ibid.*, pp. 644-645.

◆ “The only known way Enceladus could generate heat is for Saturn to raise tides in solid parts of the moon the way Earth’s moon raises tides in the oceans.” Richard A. Kerr, “Enceladus Now Looks Wet, So It May Be Alive!” *Science*, Vol. 332, 10 June 2011, p. 1259.
7. Jupiter’s moon, Io, has many volcanoes, some ejecting material 500 kilometers into space—farther than from any other volcanoes in the solar system. Tidal pumping also generates Io’s heat, but the ejected material is sulfur dioxide, not water.
8. For example, see Steven W. Squyres et al., “Liquid Water and Active Resurfacing on Europa,” *Nature*, Vol. 301, 20 January 1983, pp. 225–226.

Energy in the Subterranean Water

Extremely large explosions are often the result of a chain reaction—a rapid sequence of stages, each triggering the next stage and releasing greater magnitudes of energy. For example, a gun is fired by first applying energy to pull a trigger. That, in turn, releases the greater energy stored in a compressed spring that accelerates a firing pin into a percussion cap. Its explosion ignites the propellant that rapidly burns and generates gases that accelerate a bullet down a gun barrel.

A second but tragic example would be a large aircraft crashing into a tall building and releasing 5×10^{16} ergs of kinetic energy. The impact ignites the plane's fuel. Within an hour, 5×10^{18} ergs of chemical energy are released. That heat weakens the building's structure, causing it to collapse, releasing 10^{19} ergs of potential energy (about 25% of a small atomic bomb).

Likewise, the explosion of a hydrogen bomb is the end result of a rapid series of smaller explosions. First, a relatively tiny chemical explosion compresses nuclear fuel into a supercritical mass. This produces an atomic explosion, a fission reaction. That heat initiates a thermonuclear, or fusion, reaction—a thousand times the energy of an atomic bomb.

An astounding, literally Earth-shaking amount of energy accumulated in stages in the subterranean water before the flood. All that energy was finally released when the powerful fountains of the great deep launched water and rocks into space. Most of the rocks and water later merged and became comets, asteroids, and TNOs.¹ The four sequential energy sources were:

- ◆ tidal energy from Earth's spin and the gravitational attraction of the Sun and Moon
- ◆ chemical energy from combustion in the supercritical water (SCW)
- ◆ potential energy residing in the dense preflood crust that lay above water
- ◆ nuclear energy as explained in the chapter “**The Origin of Earth's Radioactivity**” on pages 379–433.

These four energy sources will be briefly described. But first, we will estimate the total energy that had to be in the subterranean water to launch all the matter that escaped Earth's gravity. (Note: Earth's escape velocity is 11.2 km/sec.)

Energy Required

The launched material—comets, asteroids (including the irregular moons² captured by the giant planets), and TNOs—totaled about 3% of Earth's mass. Table 44 estimates the magnitude of this energy. Some factors were derived in the comet and asteroid chapters (pages 301–374).

Table 44. Four Energy Requirements

	Total Mass M (gm)	Average Launch Velocity v (km/sec)	Kinetic Energy $E = \frac{1}{2} M v^2$ (ergs)
Comets	5.8×10^{21}	32.0	3.0×10^{34}
Asteroids (excluding TNOs)	2.6×10^{24}	11.2	1.6×10^{36}
Irregular Moons	1.3×10^{23}	11.2	8.2×10^{34}
TNOs	1.8×10^{26}	11.2	1.1×10^{38}
TOTAL:	1.83×10^{26}		1.1×10^{38}

Perhaps twice this energy was needed because a small amount of other mass (such as meteoroids and water) was launched besides that listed in Table 44 and some heat was held in the chamber's ceiling and floor. Let's assume that the total energy required was 2.2×10^{38} ergs.³ Since this energy was released over many weeks, it is more accurately described as coming from an “engine”—an “*Earth-size nuclear engine*” (as you will see)—not an explosion.

Notice in Table 44 that much more energy is needed to launch into space the rocks and water that later became TNOs than that needed to form comets, the irregular moons, and asteroids in the inner solar system. Unfortunately, great uncertainty exists on the total mass of all TNOs. [See Endnote 149 on page 375.]

Energy Available

What provided the needed 2.2×10^{38} ergs of energy? Notice that the energy released by each of the first three sources described below is huge but small compared to 2.2×10^{38} ergs. Nevertheless, each would trigger the next source. Finally, the size of the fourth source (nuclear energy) appears to have been sufficient. As explained in Endnote 89 on page 426 (and repeated below), just the production of deuterium (heavy hydrogen) in Earth's oceans released 7.72×10^{37} ergs of energy (*one-third of the needed energy*)! *Many other isotopes were produced which would have released additional energy.*

Before proceeding further, carefully consider:

- ◆ the dozens of evidences on pages 301–377 showing that the rocks and water launched into space became meteorites, comets, asteroids, and TNOs—and how flawed the standard explanations for those objects are.
- ◆ the many evidences in “**The Origin of Earth's Radioactivity**” chapter (pages 379–433) showing that *the fluttering crust generated, via the piezoelectric effect, extreme voltages that exceeded electrical breakdown voltages within rock. The resulting electrical*

surges (much like bolts of lightning passing through rock) rapidly produced Earth's radioactivity and what would be, at today's rates, billions of years' worth of daughter products. As that chapter explains and calculations and experiments show, this is much more realistic than, and far superior to, the standard, vague explanation for the origin of Earth's radioactivity—an explanation without experimental support.⁴

What were the four sources of energy?

Tidal Pumping. Twice a day, tides in the subterranean chamber compressed and stretched the pillars. As pillars were heated by tidal pumping, the water's supercritical temperature, that was quickly established during the creation week, was maintained—with heat left over to evaporate ground water that condensed each morning as heavy dew and watered the entire Earth.⁵

[To understand the heating during creation week, see [Figure 240 on page 476](#).] Quartz, which occupies about 27% of granite by volume, readily dissolves in hot water. Consequently, as temperatures rose during the creation week, the lower crust increasingly *became as porous as a sponge*. Hot, salty—and *electrically conducting—supercritical water (SCW) filled these interconnected pockets that once held quartz crystals*.

That SCW later absorbed staggering amounts of nuclear energy that were generated in the lower crust during the early weeks of the flood, thus powering all the fountains of the great deep. [See [page 126](#) and [pages 595–596](#).]

Burning.⁶ There may also have been fire in the subterranean water. SCW at high pressures and temperatures will release oxygen and, *if a fuel is present*, spontaneously burn (oxidize), releasing CO₂ (carbon dioxide), CH₄ (methane), and heat.⁷ We cannot say what fuels were present, although the great dissolving ability of SCW and the large volume of spongelike rock in contact with SCW raise many possibilities.⁸ Any heat added to the SCW by burning would have hastened the final rupture.

The products of combustion in the SCW may have produced *Earth's ores, such as iron ore*. Those ores would have been swept up to the Earth's surface with the escaping flood water.

Potential Energy. The preflood granite crust had an average thickness, t , and a density, ρ_g . It lay above a trapped water layer of density, ρ_w , and volume, V . This gave the crust a potential energy, E_p , of

$$E_p = t V g (\rho_g - \rho_w)$$

where g is the acceleration due to gravity. During the flood, that huge energy was released as the

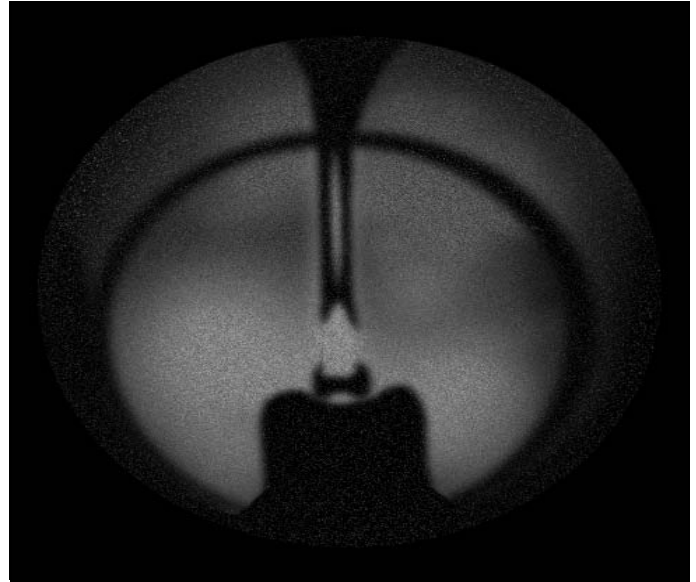

Figure 267: Burning in Supercritical Water. You are looking through a thick, sapphire window at combustion in supercritical water (SCW) at 450°C (842°F) and 1,000 bars (14,500 psi). The tube at 6 o'clock is injecting oxygen into the SCW at 3 mm³/sec. Oxygen unites with methane (CH₄) that is dissolved in the SCW and releases heat which, in turn, releases more oxygen in the water (H₂O → H + OH → 2H + O). The resulting spontaneous combustion produces CO₂ and excess heat as long as fuel (in this case, carbon) is available.⁹

At slightly higher temperatures, Russian scientists duplicated the above *without injecting oxygen* and have shown how SCW, in the presence of fuel, readily explodes from the chamber.¹⁰ Sudden jumps of 670°C (1,238°F) in temperature and 210 bars (3,000 psi) in pressure were measured.

After the Earth's crust ruptured, a similar, but vastly larger, energy release occurred for weeks in the subterranean chamber as the fluttering crust settled to the chamber floor. Most of the energy came not from chemical energy (as described above) but from nuclear energy—atomic nuclei that quickly decayed and released their binding energy. Those who ignore the flood will falsely conclude that all Earth's products of radioactive decay must have accumulated at the very slow rate they do today, so the Earth must be billions of years old.

hydroplates sank and the subterranean waters violently escaped upward. If

$$\begin{aligned} t &= 9.6 \times 10^6 \text{ cm} & V &= 7.15 \times 10^{23} \text{ cm}^3 \\ \rho_g &= 2.8 \text{ grams/cm}^3 & g &= 980 \text{ cm/sec}^2 \\ \rho_w &= 1.14 \text{ grams/cm}^3, \text{ then} \end{aligned}$$

$$E_p = 9.6 \times 10^6 \times 7.15 \times 10^{23} \times 980 (2.8 - 1.14) = 1.1 \times 10^{34} \text{ ergs}$$

At the high pressures in the subterranean chamber, water's density is 1.14 grams/cm³.

Nuclear Energy. Thermal energy from tidal pumping and burning (if fuel was present) increased the pressure in the subterranean chamber and weakened the pillars and crust. Once the crust ruptured, the potential energy was released, the subterranean water erupted, and dramatic *electrical* events occurred

that are described in “**The Origin of Earth’s Radioactivity.**” As explained in that chapter and demonstrated by experiment, new, superheavy radioisotopes rapidly formed and quickly fissioned and decayed. In the process, gigantic amounts of heat were released in the SCW.

How much of that nuclear energy was absorbed by the subterranean water? Our oceans have 1.43×10^{24} grams of water. For every 18 grams of water (1 mole) there are 6.022×10^{23} (Avogadro’s number) water molecules—each with 2 hydrogen atoms. One out of every 6,400 hydrogen atoms in our oceans is heavy hydrogen. Each fast neutron produced by the various nuclear reactions delivered at least 1 MeV of energy as it was thermalized (slowed down) by water. (1 MeV = 1.602×10^{-6} ergs) A hydrogen atom (^1H) that absorbed a fast neutron released 2.225 MeV of binding energy and became heavy hydrogen (^2H), also called *deuterium*. The comet chapter (pages 301–335) explains why Earth’s heavy hydrogen was concentrated in the subterranean chamber as the flood began. Therefore, the amount of nuclear energy that was added to the subterranean water over several weeks—just due to the production of deuterium—was:

$$\frac{1.43 \times 10^{24}}{18} \times \frac{6.022 \times 10^{23}}{6,400} \times 2 \times (1 + 2.225) \times 1.602 \times 10^{-6} \\ = 7.72 \times 10^{37} \text{ ergs}$$

Other products of nuclear decay would have added additional energy to the subterranean water, and much water was expelled from Earth, so the above is a conservative estimate of the nuclear energy that was added to the subterranean water in weeks.

Those who try to estimate the total energy that has been released by radioactive decay on Earth often make two errors. Some assume that most geothermal energy flowing up to the Earth’s surface is from nuclear decay over billions of years. As the radioactivity chapter explains, relatively little geothermal heat is from slow nuclear decay. Most geothermal heat is due to electrical surges and accelerated nuclear decay at the beginning of the flood and tectonics at the end of the flood. [The tectonic events are explained on pages 153–192.] A second error is assuming the total heat released by accelerated decay equaled the annual radioactive heat generated in the Earth’s crust today multiplied by hundreds of millions of years.

Of course, many uncertainties exist that make exact calculations impossible. For example, What were the initial and final temperatures in the subterranean chamber and what was its volume? What were the sizes, shapes, and numbers of the pillars? How much combustion occurred in the SCW? How much energy was supplied to the escaping subterranean water by all nuclear reactions,

including fissions, captures, and gamma, alpha, and beta decay? Further research should narrow these uncertainties. Nevertheless, the energy released was clearly sufficient.

Supporting Evidence

While it is shocking at first to consider—and try to grasp—the vast amount of energy in the subterranean chamber, one should also reflect on the answers it provides.

1. **Comets, Asteroids, and TNOs.** Pages 301–374 cite dozens of evidences showing that the material that merged in the years after the flood to become comets, asteroids, and TNOs was launched from Earth. The energy in the chamber was sufficient for that task.
2. **Hot Origin for Cold Comets.** Tiny rocks and dust recovered from comet Wild 2 (pronounced “Vilt 2”) in 2004 were found to have been forged in white-hot heat. This contradicts the standard story, taught since 1950, that comets formed in the coldest portion of the solar system.¹¹ (In 2005, the Deep Impact space mission made similar discoveries in comet Tempel 1.) These rocks should not have been crystalline, and yet they were crystalline and earthlike, as I predicted they would be in the 7th edition (2001, page 201). The subterranean chamber provided not only the white-hot heat and launch energy, but also the crystalline material for comets, asteroids, and meteoroids. [See “**Deep Impact Mission**” and “**Stardust Mission**” on page 308 and Item 7 on page 308.]
3. **Heavy Hydrogen.** A hydrogen nucleus contains one proton. Most hydrogen nuclei have no neutrons, but some of these nuclei (one out of every 6,400) have absorbed a neutron. They are called deuterium; hydrogen that has absorbed two neutrons is tritium.

Comets generally contain 20–100 times the concentration of heavy hydrogen as interstellar space and the solar system—and twice the concentration as Earth’s surface waters. Therefore, comets did not provide Earth with its water. [See “**Heavy Hydrogen**” on page 310.]

Only nuclear reactions produce heavy hydrogen.¹² Therefore, Earth’s water (as opposed to water or hydrogen in the rest of the universe) must have been exposed to extreme nuclear reactions. Furthermore, for comets to have so much heavy hydrogen, the water that ended up in comets must have been exposed to a high flux of neutrons. How did that happen?

Actually, all the water in comets and about half the water in our oceans came from the subterranean chamber—a chamber that absorbed a high flux of neutrons from nuclear reactions as the flood began.

Therefore, our oceans contain considerable heavy hydrogen, and comets have twice that concentration.

4. **Irregular Moons.** Most astronomers recognize that irregular moons are captured asteroids. But, how were so many captured? (Invoking long periods of time will not work, because those moons are being rapidly destroyed or stripped from their planets.) The same energy that launched water and rocks that later merged to become comets and asteroids also scattered an “ocean” of water vapor into the solar system. That gas provided the aerobraking that allowed planets, asteroids and TNOs, and a few comets to capture moons. Today, too little water vapor is in interplanetary space, to make aerobraking possible. This baffles astronomers, but is explained by the hydroplate theory.
5. **Ore Deposits.** Geologists have difficulty explaining the origin of Earth’s ore deposits. “Ore deposits of sufficient richness to be economically extracted require very unusual and powerful geologic processes which are rarely explained,”¹³ other than vague references to “hydrothermal solutions.” Yes, extremely hot water containing valuable dissolved metals (gold, silver, copper, aluminum, mercury, platinum, zinc, and a dozen others) has escaped up onto Earth’s surface where, as the water cooled, the dissolved metals precipitated into small pockets called *ore bodies*. But how did this happen—and when? Why don’t we see all these metals being deposited today? Evolutionists can only say that ore bodies must have formed slowly millions of years ago. Because it is difficult to imagine Earth’s conditions millions of years ago, or what has transpired since then, that vague explanation ends the inquiry.

The hydroplate theory has already answered these questions. Supercritical water (SCW) was generated by tidal pumping in the subterranean water chamber. From there, it dissolved various minerals in the ceiling of the subterranean chamber, which allowed the mineral-rich water to migrate up through the spongelike lower crust. Of course, most of that hot water escaped during the flood, but hot, mineral-rich water contained in those spongelike pockets also escaped along major faults after the flood. For example, dissolved minerals spilled out of a major fault in Jerome, Arizona, where billions of dollars worth of gold, silver, copper, and zinc ore were mined from 1876–1953.¹⁴ Jerome lies at the southern edge of the Colorado Plateau. Undoubtedly, the geologic disturbances caused by the uplift of the Colorado Plateau produce that fault. Because the flood was recent, we can still see this SCW escaping up from the ocean floor as black smokers. [See [Figure 56 on page 125](#).]

6. **Gold Deposits.** Why are gold veins at the Earth’s surface? If extremely hot water (932°F or 500°C) circulated under and through the lower crust, gold in high concentrations would go into solution. If the solution then came up to the Earth’s surface fast enough, most gold would precipitate. About 250 cubic miles of water must have burst forth to account for the gold found in just one gold mining region in Canada.¹⁵ With less-extreme pressure-temperature conditions, even more water must come up faster to account for the Earth’s gold deposits. These are hardly the slow, uniformitarian processes that evolutionists visualize. When the hydroplates crashed, vast amounts of hot water still under the crust burst up through faults and deposited concentrated minerals, including gold.

About 40% of all gold mined in the world is from the Witwatersrand Basin in South Africa. This gold, deposited in compressional fractures (gold veins) within the basin, precipitated from water whose temperature exceeded 300°C.¹⁶

7. **The Quartz Problem.** Geologists acknowledge their inability to explain where enough silica could come from to cement most of the Earth’s sediments into rocks. This is called “the quartz problem.” [See page 260.] SCW dissolved much of the quartz in the rocks bordering the subterranean chamber. That dissolved silica, cooling at the Earth’s surface soon after the flood, cemented rocks—and petrified wood.
8. **Salt Deposits.** Thick salt deposits on the floor of the Atlantic Ocean were not formed by evaporation but by hot brines deep in the Earth. Among the many reasons for this conclusion are the absence of organic remains in those deposits and the presence of ore minerals that are not found in evaporating basins today.¹⁷ Again, hot, erupting, mineral-rich subterranean water explains what we see.
9. **Geothermal Heat.** As one descends deeper into the Earth, temperatures increase. Many scientists and laymen believe that Earth’s geothermal heat is left over from the formation of the Earth by meteoritic bombardment. A few simple calculations show that if Earth formed that way, too much heat would have been released; the entire Earth would have melted several times over. [See Endnote 45a on page 87 and “[Melting the Inner Earth](#)” beginning on page 603.] Others believe that billions of years of radioactive decay produced the temperature patterns we see inside the Earth. The flaws in this thinking are explained in “[The Origin of Earth’s Radioactivity](#)” on pages 379–433.
10. **Understanding Accelerated Decay.** For more than 20 years, I, along with a few other creationists, have cited evidence that rates of radioactive decay were

much faster sometime in the past. In 2005, some creationists, citing several additional evidences, correctly reached the same conclusion. However, they did not know what produced Earth's radioactivity, what caused accelerated decay or when either happened (during the creation,¹⁸ the fall, or the flood). They realized that the decay, whenever it happened, would have produced a vast amount of heat—enough, they thought, to melt much of the Earth and evaporate all the oceans. Because this did not happen, they believe that a miracle occurred or some strange, new physics removed the heat. (Miracles should not be invoked to solve a scientific problem. See Figure 255 on page 559.)

In fact, normal physics was involved. These researchers never addressed the larger question: *What was the origin of Earth's radioactivity?* They were also unaware of all the preflood subterranean water and why it became electrically conductive SCW and increasingly permeated the lower crust. ***That SCW absorbed most***

of the nuclear energy and converted it primarily to kinetic energy, without a huge rise in temperature. Furthermore, the extremely powerful fountains of the great deep expelled most of that energy into outer space. Some of these researchers completely missed the cataclysmic nature of the flood's beginning—saying that when, “*on the same day all the fountains of the great deep burst open*” (Genesis 7:11), the fountains were simply like geysers. These individuals also did not realize that the hydroplate theory explains the accelerated decay and energy removal, and places that decay at the beginning of the flood.¹⁹

Final Thoughts

The origin and consequences of so much energy in the subterranean water are startling new ideas. Grasping and interrelating the many evidences that show this will require a period of thoughtful reevaluation and reflection by each reader. Put aside intuition, and follow the evidence.

References and Notes

1. Large rocks ejected from Earth had correspondingly large spheres of influence that expanded as other matter—aided by water vapor and aerobraking—gently merged around those “rock seeds.” This allowed the capture of even more matter, eventually forming “fluffy” comets, very low density asteroids, and TNOs. [Spheres of influence are explained on page 303.]
2. Irregular moons have high eccentricity and inclination and very low mass. Most astronomers recognize that irregular moons are captured asteroids, but admit that captures are too improbable. So, how did they occur?
Pages 337–374 explain how, for years after the flood, the radiometer effect and aerobraking (from the abundant water vapor in the solar system) produced those captures. At least 43 moons in the solar system are irregular; one of the largest is Saturn's Enceladus, whose “strange behavior” is explained on page 346. Mars' two tiny moons, Phobos and Deimos, are probably captured asteroids.
3. A 1-megaton hydrogen bomb releases 4.184×10^{22} ergs of energy. Therefore, it would take the explosion of 5,000 trillion hydrogen bombs to release 2.2×10^{38} ergs of energy!
However, most of the energy in the subterranean water was generated continually over many weeks (not one big explosion) and was focused up through the rupture and expelled into space. Comets, asteroids, TNOs, irregular moons, and meteoroids have great kinetic and potential energy.
4. See “[Why Do We Have Radioactivity on Earth?](#)” on page 122, and Endnote 33 on page 142.
5. Earth's polar moment of inertia is 8.068×10^{44} gm cm². Of course, we do not know how much Earth's spin slowed during this period of tidal pumping. However, if the Earth rotation slowed by 3 minutes (from a 23 hours and 57 minutes per day to today's 24 hours per day), the energy lost from Earth's rotational kinetic energy and gained as heat in the subterranean water would have been

$$\frac{1}{2} \times 8.068 \times 10^{44} \left[\frac{2\pi}{24 \times 3600} \right]^2 \left[\left(\frac{24}{23.95} \right)^2 - 1 \right] = 9 \times 10^{33} \text{ ergs}$$
6. “Burning,” in this context, is defined as the rapid chemical reaction of oxygen with a fuel, releasing heat and light.
7. A. A. Vostrikov et al., “The Effect of Thermal Explosion in a Supercritical Water,” *Technical Physics Letters*, Vol. 27, 2001, pp. 847–849.
8. Burning hydrogen (H) to produce water (H₂O) did not result in a net increase in energy, because the energy gained (57.8 kcal/mole) equaled the energy spent in dissociating the oxygen in the first place.
9. E. U. Franck, “Experimental Studies of Compressed Fluids,” *High Pressure Chemistry and Biochemistry*, editors R. van Eldik and J. Jonas (Dordrecht, Holland: D. Reidel Publishing Company, 1987), pp. 93–116.
 - ◆ E. U. Franck, “Fluids at High Pressures and Temperatures,” *Pure & Applied Chemistry*, Vol. 59, No. 1, 1987, pp. 25–34.
10. “*It was established that water participates in the conversion process on a chemical level: in particular, oxygen from water molecules is involved in the formation of carbon oxides. Even in the absence of added molecular oxygen, the process of naphthalene [C₁₀H₈] and bitumen in a certain temperature interval exhibited an exothermic character. Upon adding O₂ into SCW, the oxidation reaction may proceed in a burning regime with self-heating [spontaneous combustion] of the mixture. Under certain conditions, the self-heating process may lead to the thermal explosion effect accompanied by ejection of*

- the substance from the reactor, which is explained by the high rate of hydrocarbon burning in SCW.*” A. A. Vostrikov et al., “The Effect of Thermal Explosion in a Supercritical Water,” *Technical Physics Letters*, Vol. 27, No. 10, 2001, p. 847.
11. “Scientists analyzing the first samples returned from a comet announced startling news this week. They are finding not the unprocessed [noncrystalline] ‘stardust’ thought to have glommed together in the frigid fringes of the early solar system, but bits of [crystalline] rock forged in white-hot heat.” Richard A. Kerr, “Minerals Point to a Hot Origin for Icy Comets,” *Science*, Vol. 311, 17 March 2006, p. 1536.
 12. “Because stars consume large amounts of [deuterium] and no process creates it in significant amounts, the amount of deuterium in the universe declines steadily.” Ron Cowen, “Too Much Deuterium?: A Chemical Mystery in the Milky Way,” *Science News*, Vol. 170, 9 September 2006, p. 172.
 13. Arthur N. Strahler, *Physical Geology* (New York: Harper & Row, Publishers, 1981), p. 551.
 - ◆ Before the flood, some men learned how to forge implements of bronze (about 88% copper and 12% tin) and iron. This noteworthy achievement (Genesis 4:22) involved more than just isolating copper, tin, and iron from rocks; it also involved combining them in solid solutions to achieve superior chemical, mechanical, and physical properties. Today, we have very large, already concentrated ore deposits of many other metals besides copper, tin, and iron.
 14. Lon Abbott and Terri Cook, *Geology Underfoot in Southern Arizona*, (Missoula, Montana, Mountain Press Publishing Company, 2007), pp.233–247.
 15. Robert Kerrich, “Nature’s Gold Factory,” *Science*, Vol. 284, 25 June 1999, pp. 2101–2102.
 16. A. C. Barnicoat et al., “Hydrothermal Gold Mineralization in the Witwatersrand Basin,” *Nature*, Vol. 386, 24 April 1997, pp. 820–824.
 - ◆ Robert R. Loucks and John A. Mavrogenes, “Gold Solubility in Supercritical Hydrothermal Brines Measured in Synthetic Fluid Inclusions,” *Science*, Vol. 284, 25 June 1999, pp. 2159–2163.
 17. “Salt deposits in deep oceanic areas are considered to be deposits from hot brine originating at great depths in the earth during tectonic movements.” V. I. Sozansky, “Origin of Salt Deposits in Deep-Water Basins of Atlantic Ocean,” *The American Association of Petroleum Geologists Bulletin*, Vol. 57, March 1973, p. 589.
 - ◆ “Salt is not an evaporitic formation or a derivative from volcanic rock; it is a product of degasification of the earth’s interior. The salt precipitated from juvenile hot water which emerged along deep faults into a basin as a result of change in thermodynamic conditions. ... the water-salt composition of the ocean and atmosphere is the product of degassing of the earth’s interior.” V. B. Porfir’ev, “Geology and Genesis of Salt Formations,” *The American Association of Petroleum Geologists Bulletin*, Vol. 58, December 1974, p. 2544.
 18. From a biblical perspective, harmful radioactive decay did not exist at the end of creation, because all God made was “very good” (Genesis 1:31).
 19. Larry Vardiman, Steven A. Austin, John R. Baumgardner, Steven W. Boyd, Eugene F. Chaffin, Donald B. DeYoung, D. Russell Humphreys, and Andrew A. Snelling, “Summary of Evidence for a Young Earth from the RATE Project,” *Radioisotopes and the Age of the Earth*, editors Larry Vardiman, Andrew A. Snelling, and Eugene F. Chaffin (El Cajon, California: Institute for Creation Research, 2005), pp. 735–772. [This was a highly publicized, \$1,500,000, 8-year research project. Because these researchers mistakenly say there is a heat problem, some people believe that the Earth required millions of years to cool.]
 - ◆ Two coauthors of the above study apparently were unaware that the hydroplate theory explains this heat removal.
 - ❖ “I also pointed out that heat is not merely a problem for accelerated decay, but also for all Creation or Flood models I know of.” D. Russell Humphreys, “Young Helium Diffusion Age of Zircons Supports Accelerated Nuclear Decay,” *Ibid.*, p. 68.
 - ❖ “All creationist models of young earth history have serious problems with heat disposal.” Andrew A. Snelling, “Radiohalos in Granites,” *Ibid.*, p. 184.

Melting the Inner Earth

Today, the Earth's density at any depth, z , is well known. Some values are given in column G of Table 46.¹ Based on those values, the mass, acceleration due to gravity, polar moment of inertia, and gravitational potential energy are calculated in columns H–K for successive spherical shells. The potential energy of a shell of mass m and radius r is

$$GM_i m \int_r^\infty \frac{dr}{r^2} = -\frac{GM_i m}{r} = -m g r$$

where G is the gravitational constant, g is the acceleration due to gravity at r , and M_i is the mass *inside* the shell.

Preflood values of density (column B) can be estimated at all depths by the formula

$$\text{density} = a + bz + cz^2 + dz^3$$

where $a = 2.840$, $b = 1.6362 \times 10^{-3}$, $c = 5.4000 \times 10^{-8}$, and $d = -1.1587 \times 10^{-11}$. These coefficients were selected to satisfy the following constraints: the flood did not appreciably change the mass of the Earth,² the preflood density at the Earth's surface and center was what it is today (2.840 and 12.460 gm/cm³, respectively), pressure and, therefore, density increased smoothly with depth, and the polar moment of inertia allowed the Earth to rotate 360 times per year. (Endnote 35 on page 185 presents some of the evidence for a 360-day year before the flood.) Other functional relationships for preflood density vs. depth that satisfied these same constraints would not greatly alter the following conclusions.

As explained on pages 153–192, during the flood, mass shifts within the Earth generated internal friction, heating, and melting. Melting, especially near the center of the Earth where pressures (and thus frictional heating) were greatest, was followed by gravitational settling of the denser minerals and chemical elements. Rock that melted below the crossover depth contracted. [See “**Magma Production and Movement**” on page 156.] This produced further mass shifts (faulting), frictional heating, melting, and gravitational settling. Most of the potential energy lost by the Earth—the difference in the sums (highlighted in yellow) of columns F and K—was converted to heat by gravitational settling.³

$$(2.489 \times 10^{39} - 2.460 \times 10^{39}) = 29.0 \times 10^{36} \text{ ergs}$$

Slippage began at the center of the Earth, as shown in “**Forming the Core**” on page 160. The potential energy lost by frictional melting eventually generated about 5 times more heat energy in the Earth's growing core through gravitational settling.⁴ This created a diminishing⁵ runaway situation: more slippage and melting produced more heating by gravitational settling, which then produced additional (but lesser amount of) slippage, melting etc. Within months, most of the inner Earth melted. *That melting, gravitational settling, and*

*compression of magma in the outer core is shown by the sharp density discontinuity highlighted in red in Table 46 (column G) and by Earth's extremely strong magnetic field. [See “**The Origin of Earth's Powerful Magnetic Field**” on page 180 for an explanation.]*

All this heat, released within months⁶ inside Earth, could provide almost 3-billion years' worth of the present heat flux at the Earth's surface (1.0×10^{28} ergs/year).

How does the heat released by gravitational settling (almost 29.0×10^{36} ergs) compare with the heat needed to form Earth's present-day core? It partly depends on the initial temperatures of the denser particles inside the Earth before they fell toward the Earth's center to become the inner and outer core. However, before gravitational settling could begin, those temperatures would have been raised to near the local melting temperatures. Particles that melted after they fell added to the liquid outer core; denser particles that did not melt or that solidified under the great pressure near the Earth's center formed the solid inner core.

Anderson gives the following estimates for the thermal properties of the inner and outer core. (The masses for inner and outer core are derived from Table 46.)

Table 45. Some Properties of the Earth's Core⁷

Property	Inner Core	Outer Core
Mass (gm)	0.132×10^{27}	1.831×10^{27}
Mean Melting Temperature (K)	6,575	3,800
Specific Heat (erg/gm/K)	5×10^6	5×10^6
Heat of Fusion (erg/gm)		4×10^9

To form today's inner core requires approximately

$$[5 \times 10^6 \times (6,575 - 3,800)] \times 0.132 \times 10^{27} = 1.832 \times 10^{36} \text{ ergs}$$

To form today's outer core requires approximately

$$(4 \times 10^9) \times (1.831 \times 10^{27}) = 7.324 \times 10^{36} \text{ ergs}$$

Therefore, the heat released by gravitational settling (almost 29.0×10^{36} ergs) exceeded that needed to form the Earth's inner and outer core (9.156×10^{36} ergs). Temperatures quickly rose near the center of the Earth. Notice that the heat released by gravitational settling, *if evenly distributed throughout the Earth*, might melt the entire Earth, whose mass is 5.976×10^{27} grams.

$$29.0 \times 10^{36} \text{ ergs} > (\sim 4 \times 10^9) \times (5.976 \times 10^{27}) \text{ ergs}$$

Table 46 allows two other important conclusions. Evolutionists claim that the Earth formed by meteoritic bombardment, sometimes called *gravitational accretion*.

Table 46. Energy Released by Gravitational Settling

		BEFORE FLOOD					AFTER FLOOD				
	A	B	C	D	E	F	G	H	I	J	K
	depth z (km)	density (gm/cm ³)	mass (gm)	gravity (cm/sec ²)	inertia (gm cm ²)	potential energy (ergs)	density (gm/cm ³)	mass (gm)	gravity (cm/sec ²)	inertia (gm cm ²)	potential energy (ergs)
Crust	0	2.840		982.2			2.840		982.2		
	15	2.865	2.18E+25	983.2	5.88E+42	-1.36E+37	2.840	2.17E+25	983.2	5.85E+42	-1.36E+37
	60	2.938	6.58E+25	986.2	1.76E+43	-4.10E+37	3.332	7.54E+25	984.7	2.02E+43	-4.70E+37
	100	3.004	5.91E+25	988.8	1.56E+43	-3.67E+37	3.348	6.64E+25	986.1	1.75E+43	-4.12E+37
	200	3.169	1.50E+26	994.9	3.87E+43	-9.26E+37	3.387	1.64E+26	989.6	4.23E+43	-1.01E+38
	300	3.335	1.53E+26	1,000.2	3.83E+43	-9.35E+37	3.424	1.60E+26	993.4	4.01E+43	-9.73E+37
	350	3.419	7.76E+25	1,002.6	1.89E+43	-4.70E+37	3.441	7.88E+25	995.5	1.92E+43	-4.74E+37
	400	3.502	7.82E+25	1,004.8	1.87E+43	-4.70E+37	3.775	8.44E+25	996.4	2.02E+43	-5.04E+37
	413	3.524	2.04E+25	1,005.4	4.84E+42	-1.22E+37	3.795	2.20E+25	996.6	5.22E+42	-1.31E+37
	500	3.670	1.38E+26	1,008.8	3.21E+43	-8.19E+37	3.925	1.48E+26	997.5	3.44E+43	-8.71E+37
	600	3.839	1.60E+26	1,012.0	3.61E+43	-9.40E+37	4.075	1.70E+26	998.6	3.85E+43	-9.90E+37
Mantle	650	3.923	8.05E+25	1,013.4	1.77E+43	-4.68E+37	4.150	8.53E+25	998.7	1.88E+43	-4.90E+37
	800	4.178	2.43E+26	1,016.4	5.17E+43	-1.39E+38	4.380	2.58E+26	997.8	5.48E+43	-1.45E+38
	984	4.491	3.01E+26	1,017.9	6.02E+43	-1.68E+38	4.529	3.09E+26	996.0	6.19E+43	-1.69E+38
	1,000	4.519	2.62E+25	1,017.9	5.06E+42	-1.43E+37	4.538	2.64E+25	995.8	5.09E+42	-1.41E+37
	1,200	4.861	3.28E+26	1,016.4	6.07E+43	-1.76E+38	4.655	3.21E+26	994.3	5.95E+43	-1.68E+38
	1,400	5.205	3.25E+26	1,012.1	5.58E+43	-1.67E+38	4.768	3.05E+26	993.7	5.22E+43	-1.54E+38
	1,600	5.549	3.21E+26	1,004.7	5.08E+43	-1.58E+38	4.877	2.88E+26	994.5	4.55E+43	-1.39E+38
	1,800	5.893	3.14E+26	994.4	4.57E+43	-1.46E+38	4.983	2.70E+26	997.1	3.94E+43	-1.26E+38
	2,000	6.236	3.05E+26	981.1	4.06E+43	-1.35E+38	5.087	2.53E+26	1,002.1	3.37E+43	-1.13E+38
	2,200	6.578	2.94E+26	964.8	3.58E+43	-1.22E+38	5.188	2.36E+26	1,010.2	2.87E+43	-1.01E+38
	2,400	6.918	2.81E+26	945.5	3.11E+43	-1.09E+38	5.288	2.18E+26	1,022.3	2.41E+43	-9.03E+37
	2,600	7.256	2.67E+26	923.3	2.67E+43	-9.66E+37	5.387	2.01E+26	1,039.3	2.01E+43	-8.02E+37
	2,800	7.590	2.51E+26	898.1	2.26E+43	-8.41E+37	5.487	1.84E+26	1,062.6	1.66E+43	-7.11E+37
	2,878	7.720	9.36E+25	887.5	7.79E+42	-2.95E+37	5.527	6.73E+25	1,073.8	5.60E+42	-2.54E+37
	3,000	7.922	1.41E+26	869.9	1.11E+43	-4.26E+37	10.121	1.81E+26	1,046.7	1.42E+43	-6.59E+37
	3,200	8.249	2.17E+26	838.9	1.55E+43	-6.08E+37	10.421	2.76E+26	999.6	1.97E+43	-9.25E+37
	3,400	8.572	1.99E+26	804.9	1.26E+43	-5.03E+37	10.697	2.50E+26	949.5	1.58E+43	-7.49E+37
	3,600	8.890	1.81E+26	768.1	9.96E+42	-4.09E+37	10.948	2.24E+26	896.7	1.23E+43	-5.94E+37
	3,800	9.202	1.62E+26	728.5	7.74E+42	-3.24E+37	11.176	1.98E+26	841.4	9.46E+42	-4.61E+37
Outer Core	4,000	9.507	1.44E+26	686.2	5.86E+42	-2.51E+37	11.383	1.73E+26	783.9	7.07E+42	-3.48E+37
	4,200	9.806	1.25E+26	641.2	4.32E+42	-1.89E+37	11.570	1.49E+26	724.4	5.13E+42	-2.55E+37
	4,400	10.098	1.07E+26	593.6	3.08E+42	-1.37E+37	11.737	1.26E+26	663.0	3.61E+42	-1.81E+37
	4,600	10.382	9.02E+25	543.5	2.11E+42	-9.59E+36	11.887	1.04E+26	600.0	2.44E+42	-1.23E+37
	4,800	10.657	7.39E+25	491.0	1.38E+42	-6.39E+36	12.017	8.40E+25	535.6	1.57E+42	-7.97E+36
	4,982	10.899	5.41E+25	441.1	7.94E+41	-3.73E+36	12.121	6.05E+25	475.9	8.90E+41	-4.53E+36
	5,000	10.923	4.70E+24	436.1	5.97E+40	-2.85E+35	12.130	5.22E+24	469.9	6.63E+40	-3.41E+35
	5,121	11.079	2.87E+25	401.9	3.30E+41	-1.58E+36	12.197	3.18E+25	429.6	3.65E+41	-1.87E+36
	5,200	11.179	1.62E+25	379.2	1.58E+41	-7.66E+35	12.229	1.78E+25	403.1	1.74E+41	-8.96E+35
	5,400	11.426	3.27E+25	320.3	2.54E+41	-1.22E+36	12.301	3.55E+25	335.4	2.75E+41	-1.40E+36
Inner Core	5,600	11.662	2.21E+25	260.0	1.14E+41	-5.59E+35	12.360	2.36E+25	267.1	1.22E+41	-6.20E+35
	5,800	11.886	1.34E+25	199.5	4.18E+40	-2.07E+35	12.405	1.41E+25	198.2	4.39E+40	-2.20E+35
	6,000	12.099	6.79E+24	143.7	1.08E+40	-5.49E+34	12.437	7.03E+24	129.0	1.12E+40	-5.42E+34
	6,200	12.299	2.35E+24	139.6	1.41E+39	-9.03E+33	12.455	2.40E+24	59.5	1.44E+39	-6.13E+33
	6,371	12.460	2.59E+23	0.0	3.03E+37	-1.55E+32	12.460	2.61E+23	0.0	3.05E+37	-6.64E+31
	SUM		5.976E+27		8.14E+44	-2.460E+39		5.976E+27		8.03E+44	-2.489E+39

If so, the 2.489×10^{39} ergs of potential energy lost by these meteoroids (sum of column K) would become heat after impact with the growing Earth. This is 86 times greater than the heat released by gravitational settling.

$$\frac{2.489 \times 10^{39}}{29.0 \times 10^{36}} = 86$$

It is also 104 times the heat needed to melt the entire Earth.

$$\frac{2.489 \times 10^{39}}{4 \times 10^9 \times (5.976 \times 10^{27})} = 104$$

Even if the bombardment were spread over millions of years, the entire Earth should have melted, as experts have noted.⁸ Had this happened, we would not find heavy, nonreactive chemical elements, such as gold, at the Earth's surface, nor would granite exist. [See "Molten Earth?" on page 87 and Endnote 23 on page 183.]

Conclusion

By assuming a uniform density distribution throughout the preflood Earth (altered only by the compression that increases with depth), the hydroplate theory and

gravitational settling answer the many questions raised in "Volcanoes and Lava" on page 118 and "Geothermal Heat" on page 118. This also explains why the inner core spins faster than the rest of the Earth (page 159), and why George Dodwell found that the tilt of the Earth's spin axis has steadily changed during the last 4,000 years. [See page 122 and Endnote 84 on page 148.] Finally, the hydroplate theory and gravitational settling explain the following unusual characteristics of today's Earth:

- ◆ the huge density discontinuity at the core-mantle boundary (highlighted in red on page 604),
- ◆ Earth's liquid outer core and solid inner core,
- ◆ "oceans" of flood basalts found worldwide, especially in and surrounding the Pacific and Indian Oceans,
- ◆ oceanic trenches and the Ring of Fire (explained on (pages 153–192),
- ◆ the 40,000 volcanoes (all taller than 1 kilometer) on the floor of the Pacific Ocean,
- ◆ the great variability of the temperature gradient under the Earth's surface (discussed on page 118), and
- ◆ Earth's powerful magnetic field—2,000 times greater than the combined magnetic fields of all the rocky planets. [See "The Origin of Earth's Powerful Magnetic Field" on page 180.]

References and Notes

1. See, for example, Frank D. Stacey, *Physics of the Earth* (New York: John Wiley & Sons, Inc., 1969), pp. 281–282.
2. The mass expelled from Earth during the flood was probably less than 2.8×10^{24} grams, less than 1/2,000 the mass of the Earth. [See Table 44 on page 597.] Therefore, that lost mass can be neglected. Even if it could not be neglected, it would have only a secondary effect, because the loss of that mass would not alter Earth's spin rate.
For example, the ice skater shown in Figure 84 on page 154 will spin faster as she pulls her arms in toward her spin axis. However, if her arms ever flew off her spinning body, her spin rate would immediately stop increasing.
3. Only a very small fraction of the preflood Earth's potential energy was expended in increasing the Earth's rotational kinetic energy. The Earth's angular velocity today is

$$\omega = 7.29211 \times 10^{-5} \frac{\text{radians}}{\text{sec}}$$

This faster spin rate increased the Earth's rotational kinetic energy despite Earth's lower polar moment of inertia. However, this increase was relatively trivial and can be neglected.

$$\frac{1}{2} \left[8.03 \times 10^{44} \omega^2 - 8.14 \times 10^{44} \left(\frac{360}{365.25} \omega \right)^2 \right] = 3.25 \times 10^{34} \text{ ergs}$$

4. This factor of 5 can be estimated by calculating the ratio of the energy released by gravitational settling just within the

outer core ($\Delta\rho g V h$) to the energy expended in melting ($L V \rho_{av}$), where

- $\Delta\rho$ = the average density *difference* between particles that sink to the particles that float,
- g = the average acceleration of gravity in the core,
- V = the volume of melted rock in the outer core,
- h = the average "fall distance" (about half the radius of the outer core),
- L = the heat of fusion in the outer core, and
- ρ_{av} = average density of the melted particles.

$$\text{If } \begin{array}{ll} g \approx 500 \text{ cm/sec}^2 & h \approx 1,750 \times 10^5 \text{ cm} \\ L \approx 4 \times 10^9 \text{ ergs/gm} & \frac{\Delta\rho}{\rho_{av}} \approx 0.23 \end{array}$$

then this dimensionless ratio is about 5.

$$\frac{g h}{L} \times \frac{\Delta\rho}{\rho_{av}} \approx \frac{500 \times 1,750 \times 10^5}{4 \times 10^9} \times 0.23 \approx 5 \gg 1$$

Any ratio that is much greater than 1.0 will produce runaway heating near the center of the Earth. (Other minor effects are being omitted.) Clearly, this factor is large because h (the "fall distance") is so large. With about 5 times more heat in the core than it takes to melt the outer core, **heat within the outer core should be conducting today into and melting the base of the mantle and the top of the inner core.**

- As shown in “**Forming the Core**” on page 160, the runaway melting diminishes, because the solid mantle’s radial movement diminishes as the core’s radius increases. At the exact center of the Earth, that movement—and the resulting friction, melting, and shrinkage of magma—was a maximum.
- To understand why most of this heat was released within months, see “**Why Did the Flood Water Drain So Slowly**” on page 503.

- Don L. Anderson, *Theory of the Earth* (Boston: Blackwell Scientific Publications, 1989), p. 68.
- “*The kinetic energy ($\sim 5 \times 10^{38}$ ergs) released in the largest impacts (1.5×10^{27} g at 9 km/sec) would be several times greater than that required to melt the entire Earth.*” George W. Wetherill, “Occurrence of Giant Impacts during the Growth of the Terrestrial Planets,” *Science*, Vol. 228, 17 May 1985, p. 879.

Frequency of the Fluttering Crust

Method 1. We can approximate the fluttering frequency of the crust by modeling a narrow section of the crust as a frictionless granite piston of mass M and density ρ_g compressing water of density ρ_w . The piston, with an area A and thickness t , is free to vibrate up and down, much like a massive ship bobbing up and down on the sea.

The piston’s mass is

$$M = A t \rho_g$$

A downward displacement of the crust by distance $+x$ will produce an unbalanced restoring force (F), in the negative direction, of

$$F = -(\rho_w g x) A$$

where g is the acceleration due to gravity. Therefore, using Newton’s second law, the equation of vertical motion is

$$A t \rho_g \frac{d^2 x}{dt^2} = -(\rho_w g x) A \quad \text{or}$$

$$\frac{d^2 x}{dt^2} + \left(\frac{\rho_w}{\rho_g} \right) g \frac{x}{t} = 0$$

The solution to this differential equation can be written as

$$x = a \sin \omega (t - t_0)$$

where “ a ” is the amplitude, t is the time at any instant, t_0 is the time when the crust is at its equilibrium position and moving downward, and the natural frequency ω is

$$\omega = \frac{1}{2\pi} \sqrt{\frac{g}{t} \left(\frac{\rho_w}{\rho_g} \right)}$$

Therefore, the period (P) is

$$P = \frac{1}{\omega} = 2\pi \sqrt{\frac{t}{g} \left(\frac{\rho_g}{\rho_w} \right)}$$

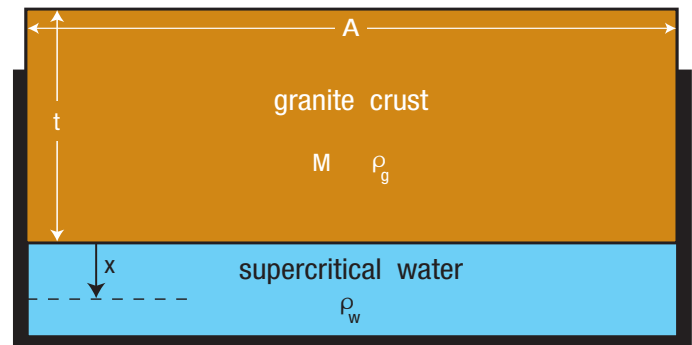

Figure 268: Vibrating Crust. While the fluttering crust would look like a flag held horizontally in a strong wind, its chaotic movement can be simplified by looking at the narrow section shown above. Its movement would primarily be up and down, driven by the oscillating pressure below.

From the steam table for supercritical water (SCW) mentioned in Endnote 14 on page 210, the density (ρ_w) of SCW at 25,550 bars and 3,000°F is about $0.9 \frac{gm}{cm^3}$. If

$$g = 980 \frac{cm}{sec^2}, \quad \rho_g = 2.8 \frac{gm}{cm^3}, \quad \text{and} \quad t = 9.6 \times 10^6 \text{ cm}$$

the vibrational period is *7.5 minutes per cycle*. Other factors, such as water hammers, the partially removed pillars, and the stiffness of the crust could greatly alter this period.

Method 2. Analyses exist for the vibration of flat plates. [See for example Carl Roger Freberg and Emory N. Kemler, “Vibration of Thin Flat Plates,” *Elements of Mechanical Vibration*, 2nd edition (New York: John Wiley & Sons, Inc., 1949, pp. 147–148.)] While these models have the advantage of incorporating a plate’s thickness and stiffness (modulus of elasticity), one must know the distance between supports, which for hydroplates requires knowing the number and spacing of the preflood pillars. While any estimate would be hard to justify, I will assume there were 18,000 evenly spaced pillars before the flood—the estimate previously used in Endnote 2 on page 474. With this spacing, these models give vibrational periods slightly greater than *43 minutes per cycle*. Although uncertainties exist with both methods, the vibrational periods will be considered to be about 30 minutes.

Rapid Attraction

Two electrical charges (Q_1 and Q_2 statcoulombs, one positive and the other negative) are attracted toward each other by a force of F dynes when they are separated by a distance of x centimeters in a medium with permittivity k .

$$F = k \frac{Q_1 Q_2}{x^2}$$

For a vacuum, $k = 1$. One statcoulomb is the charge of 2.08×10^9 electrons.

Stokes' law gives the terminal velocity of a sphere of mass m and radius r which is acted upon by a force F in a fluid whose viscosity is μ . That velocity is

$$v = \frac{dx}{dt} = \frac{2 \rho \left(\frac{F}{m} \right) r^2}{9 \mu}$$

The sphere's density, ρ , is

$$\frac{m}{\frac{4}{3} \pi r^3}$$

These equations simplify to

$$x^2 \frac{dx}{dt} = \frac{k Q_1 Q_2}{6 \pi \mu r}$$

Integrating this from an initial separation distance of x_0 until the charged particles collide ($x = 0$) at time t gives:

$$\int_{x_0}^0 x^2 dx = \frac{k Q_1 Q_2}{6 \pi \mu r} \int_0^t dt$$

$$-\frac{x_0^3}{3} = \frac{k Q_1 Q_2}{6 \pi \mu r} t$$

What does this mean? Consider trillions of radon-222 (^{222}Rn) atoms flowing for weeks between sheets of mica that are growing, because the mineral-rich water's temperature and pressure are dropping. If ^{222}Rn (half-life = 3.8 days) ejects an alpha particle (charge = +2), the radon instantly becomes ^{218}Po with a charge of $Q_1 = -2$ and a radius $r = 5 \times 10^{-8}$ centimeters. That polonium ion will recoil with enough energy to remove hundreds of hydroxide ions (OH^-)—each with a negative charge—from near the impact point in the mica. [For an explanation of dehydroxylation, see Endnote 130 on page 430.] While the water might absorb some recoil energy, or the polonium

might be deflected off a mica sheet, some recoiling ^{218}Po will crash into and become embedded in the mica, removing hundreds of hydroxide ions. This will give the impact point a large positive charge—both from the impact and the greater heating minutes later when the embedded ^{218}Po decays by emitting an alpha particle.

Let's conservatively say that the first impact in the mica produces a charge of $Q_2 = +100$. For water,

$$k = 0.0123 \frac{\text{dynes cm}^2}{(\text{statcoulombs})^2} \text{ and } \mu = 0.003 \frac{\text{dynes sec}}{\text{cm}^2}$$

Other flowing ^{222}Rn atoms that decay near that +100 point charge will be pulled into it within one ^{218}Po half-life (3.1 minutes) if

$$x_0 \leq \left[\frac{-k Q_1 Q_2 t}{2 \pi \mu r} \right]^{\frac{1}{3}} = \left[\frac{-0.0123 (-2) (+100) (3.1 \times 60)}{2 \pi (0.003) 5 \times 10^{-8} (2.08 \times 10^9)^2} \right]^{\frac{1}{3}}$$

$$= 0.0048 \text{ cm}$$

This is more than twice the radius of a ^{218}Po halo. As more radon decays near the impact point and as more ^{218}Po , ^{214}Po , and ^{210}Po are pulled into the impact point and then decay, the heating and recoil pressure remove more hydroxide ions, increasing the electrical charge Q_2 . That, in turn, increases the distance, x_0 and the rate at which polonium is pulled in. A runaway situation quickly develops.

The formula for biotite is $\text{K}(\text{Mg,Fe})_3(\text{Al,Fe})\text{Si}_3\text{O}_{10}(\text{OH,F})_2$. Approximately 17/400 of its mass is OH^- (highlighted in bold above). A typical inclusion at the center of a polonium halo has a radius of about 0.00005 cm. Therefore, that tiny volume of biotite, whose density is 3.1 gm/cm^3 , initially had about

$$\frac{17}{400} \times \frac{4}{3} \pi (5 \times 10^{-5})^3 \times 3.1 (6.022 \times 10^{23}) = 4.15 \times 10^{10}$$

OH^- ions.

If dehydroxylation removed only 1/20th of these ions, about a billion polonium ions could be attracted and concentrated, enough to form a sharp halo.



PREDICTION 57: A sensitive mass spectrometer will show about a 5% deficiency in hydrogen within the inclusions at the center of isolated polonium halos.

Highly Compressed Solids

A granite cliff on Earth could never be higher than 5 miles. Granite typically has a crushing strength of 2.11×10^8 newtons/meter² and weighs 26,400 newtons/meter³. Dividing the first number by the second gives 8,000 meters (or 5 miles)—the maximum height before the granite at the base of the cliff is crushed by the load above. (If the entire cliff were under water, buoyancy would allow the cliff to be about 60% higher.)

Let's examine a more general case and then apply it to several specific examples including the one above. If a tiny cube of any solid is compressed on all six sides by equal pressures (stresses) that exceed the solid's crushing stress, would the cube be crushed into tiny pieces? No. The confinement pressure is so large and uniform that no tiny fragment of the cube could slip relative to an adjacent fragment. With no shearing stresses in the cube, it would only shrink uniformly, according to Hook's law: by an amount proportional to the stress. (The subjects of Poisson's ratio and Mohr's circle can be skipped with no loss of generality.) Therefore, a fragile glass goblet, or any solid, would not break or be penetrated by water if it were gently placed at the deepest point on an ocean floor, where compressive stresses are gigantic but uniform. Indeed, many of us have seen pictures of delicate, unbroken china in the deep ocean wreckage of the *Titanic*.

Why is a solid not crushed if the compressive stresses exceed the crushing strength and are equal in all directions? The crushing strength of a solid is defined as the *axial* compression required to fracture a test cylinder of that material. Because there is no external compression on the sides of the test cylinder, internal shearing stresses must develop to try to counter that axial compression. Those shearing stresses, comparable to the axial stresses in magnitude, cause mineral grains to slip at grain boundaries, the weakest part of solids.

If each side of a tiny, confined cube is compressed by large, *unequal* stresses, internal shearing stresses will develop and deform the original cube. Within the cube are countless grain boundaries between adjacent crystals. If the stresses on the sides of the cube are large and sufficiently different, internal shearing stresses at grain boundaries will break the weakest atomic bonds, produce slippage (dislocations) at grain boundaries, and make the internal stresses nearly hydrostatic. This is putty-like—or plastic—deformation by compression.

The side of a tiny granite cube that was part of a cliff face (or the inside wall of a deep drill hole) would have no compressive stress acting on it. Therefore, internal shearing stresses would try to compensate. If at least 5 miles of granite were loaded above the cube, those shearing

Figure 269: Hydrostatic Compression. Hydrostatic compression occurs when a tiny cube of material (solid or liquid) is compressed equally and uniformly on all six sides, and no stresses lie in the faces of the six sides. Because liquids can sustain no shear stresses, this is automatically true for pressurized liquids. Thus the name "hydro-static" compression. Nevertheless, the term is also used for solids, especially rocks deep in the Earth.

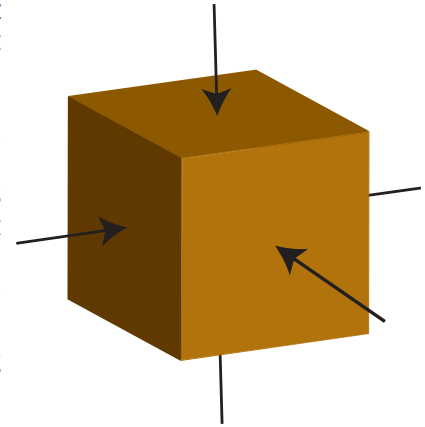

The imaginary cube usually lies within a larger mass of the same material. Under hydrostatic conditions, no shear stresses exist within the cube. However, with rocks, the compressive forces on the sides of the cube are often unequal, so shear stresses will develop within the cube to try to balance the differences. Those stresses deform the cube to some degree.

For deep rocks, compressive deformations are primarily puttylike, not elastic (or springlike). The greater the compressive deformations, the more the rock deforms and shear stresses disappear—as in a liquid. When drilling into the Earth, hydrostatic rocks are encountered at depths of about 5 miles. As drills approach those depths, dense liquids must be added to the drill hole to keep it from collapsing.

stresses would fracture the granite cube, and the pieces would spill out of the cliff face, or into the drill hole.

Other variables affect the compressive strength of solids and the point where plastic deformation by compression begins. The higher the temperature, the weaker the compressive strength. Also, the mere process of deforming a solid generates internal friction that heats and weakens the solid. Defects within crystals are sources of weakness and may produce an early onset of puttylike deformations. Even so, as a general rule, granite 5 miles or more below the Earth's surface will tend to deform until the compressive loads are almost hydrostatic—equal in all directions and without shear stresses. Any liquid below that solid seal (such as the preflood subterranean ocean) will be trapped, unless forces rupture the seal. High-pressure fluids are often sealed in their containers by gaskets or sealants made of highly-compressed, but malleable, solids.

Most advocates of plate tectonics think of the mantle as a highly viscous liquid. (Textbooks and young minds are filled with this error as well as the belief that the mantle circulates like a liquid.) No, the mantle is almost entirely a solid—a highly compressed solid. [See Figure 96 and "Reasonable Driving Mechanisms" on page 173.]

Consequences of Evolving Earth by Meteoritic Bombardment

Evolutionists teach that the Earth grew by meteoritic bombardment. If so, consider what would have happened. Earth's mass and radius would have steadily increased and become today's mass (M) and radius (R). While the Earth was growing, these values were variables, m_e and r .

If a small meteorite of mass, m , falls onto the growing Earth from a distance D , it will deliver

$$\int_r^D \frac{G m_e m}{x^2} dx = G m_e m \left(\frac{1}{r} - \frac{1}{D} \right) \quad (1)$$

units of heat energy to the Earth, where G is the gravitational constant. Because

$$\frac{1}{r} \gg \frac{1}{D}$$

Equation (1) can be simplified to

$$\frac{G m_e m}{r}$$

For each incremental increase in the growing Earth's mass, the Earth's radius will increase by dr .

$$m = 4 \pi r^2 \rho dr$$

where the average density of the Earth is

$$\rho = \frac{M}{\frac{4}{3} \pi R^3}$$

Summing up the total energy, E , delivered to Earth as it grows from a radius 0 to radius R gives

$$\begin{aligned} E &= \int_0^R \frac{G m_e m}{r} dr = \int_0^R \frac{G \left(\frac{4}{3} \pi r^3 \rho \right) (4 \pi r^2 \rho dr)}{r} \\ &= G \frac{16}{3} \pi^2 \rho^2 \int_0^R r^4 dr = G \frac{16}{15} \pi^2 \rho^2 R^5 \\ &= \frac{3}{5} \frac{G M^2}{R} \end{aligned}$$

This energy amounts to 3.75×10^{14} ergs/gram.¹ To appreciate just how large this heat energy is, recognize that TNT (a powerful explosive) contains only 1.6×10^{10} ergs/gram. Simply stated, the heat delivered to Earth by meteoritic bombardment would be 23,000 times greater than the energy of an explosion of an Earth composed of only TNT.

Planetesimal masses impacting an evolving Earth would range up to 1.5×10^{27} grams. Large planetesimal impacts alone would melt the Earth several times over.

The kinetic energy ($\sim 5 \times 10^{38}$ ergs) released in the largest impacts (1.5×10^{27} g at 9 km/sec) would be several times greater than that required to melt the entire Earth.”²

Runaway Greenhouse Effect. Long before the Earth became molten, another problem would occur. The Sun delivers each second an average of 1.39×10^6 ergs of energy to every square centimeter that is perpendicular to the Sun's rays at the top of Earth's atmosphere. This number is called the *solar constant*. If the energy delivered to Earth by the Sun or by impacts (or both) were 40% greater, the Earth would experience a runaway greenhouse.³ That is, more water would evaporate from Earth's surface, so too much heat trying to escape into outer space would be blocked by water vapor in the atmosphere. That, in turn, would evaporate more water and accelerate the process. Temperatures would rise permanently; life on Earth would be impossible. This is occurring today on Venus where temperatures are hot enough to melt lead.

One writer recognized the problem.

The gravitational energy released during the creation of Earth in 10^8 years corresponds to almost the equivalent of 1 solar constant. If all or most of this energy was reradiated and if the Earth and Venus were made in this time or less, as generally believed, then a runaway greenhouse effect would seem inevitable for both planets.”⁴

The physics is so clear that one must ask why students have been taught for 200 years that Earth formed by meteoritic bombardment (a very slow process), so Earth must be billions of years old. Could it be that challenging this ruling paradigm for Earth's origin would bring condemnation from others, including ones teachers? Would textbooks that show how the Earth did not evolve be boycotted?

References and Notes

1. One can also think of this as the energy required to disburse permanently a fragmented planet of mass M and radius R . [See Endnote 116 on page 335 and related paragraphs.]
2. George W. Wetherill, "Occurrence of Giant Impacts during the Growth of the Terrestrial Planets," *Science*, Vol. 228, 17 May 1985, p. 879.
3. "... the critical heat flow for the onset of a runaway is around 1.4 solar constants (where 1 represents the present solar input at Earth)." David J. Stevenson, "Greenhouses and Magma Oceans," *Nature*, Vol. 335, 13 October 1988, pp. 587-588.
4. Ibid.

Illustration Credits

- Figure 1: *Walt Brown, page x
 Figure 2: *Aristo Graphics, page 2
 Figure 3: *design by Bradley W. Anderson using Corel Professional Photos by Jeanne White, page 4
 Figure 4: *Bradley W. Anderson, page 6
 Figure 5: Natural History Museum, London, page 7
 Figure 6: *NASA, page 8
 Figure 7: *courtesy of Sternberg Museum of Natural History, Fort Hays State University, Hays, Kansas, page 10
 Figure 9: *Natural History Museum, Washington, D.C.; photo by Bradley W. Anderson, page 10
 Figure 10: *Bradley W. Anderson, page 10
 Figure 8: *Natural History Museum, Washington, D.C., photo by Bradley W. Anderson, page 10
 Figure 11: *used with permission of the Creation Research Society, P.O. Box 8263, St. Joseph, MO 64508-8263, page 11
 Figure 12: Natural History Museum, London, page 12
 Figure 14: *G. Elliot Smith, *Illustrated London News*, 24 June 1922, p. 944, page 13
 Figure 13: D. L. Cramer, page 13
 Figure 15: Leonid Mirny, page 18
 Figure 16: copyright William Zittrich, page 19
 Figure 17: *Corel Professional Photos, page 20
 Figure 18: copyright Boehringer Ingelheim International GmbH, photo by Lennart Nilsson, *The Incredible Machine*, National Geographic Society, page 21
 Figure 20: *drawing of microphotograph by Bradley W. Anderson, page 22
 Figure 21: Image excerpted from the video "A Question of Origins," Eternal Productions, www.eternal-productions.org. Used with permission, page 22
 Figure 19: *Arctic Tern from Corel/migration route by Bradley W. Anderson/cockpit photo by Walt Brown, page 22
 Figure 22: *Life Art Collections, TechPool Studios, page 24
 Figure 23: *NASA, page 26
 Figure 24: *NASA, page 27
 Figure 25: *composition by Bradley W. Anderson using NASA photos, page 30
 Figure 26: *NASA, page 31
 Figure 27: *PhotoDisk, Vol. 34, Spacescapes, page 35
 Figure 28: *U.S. Naval Observatory, page 36
 Figure 29: courtesy of Staatliches Museum für Naturkunde, Stuttgart, Germany, page 37
 Figure 30: *Walt Brown, page 37
 Figure 31: *used with permission, Creation Research Society, P.O. Box 8263, St. Joseph, MO 64508; composition by Bradley W. Anderson, page 38
 Figure 32: *NASA, page 40
 Figure 33: *composition by Bradley W. Anderson using NASA photos, page 41
 Figure 34: *L. A. Frank, The University of Iowa, page 42
 Figure 35: *PhotoDisk, Vol. 34, Spacescapes, page 43
 Figure 36: *composition by Bradley W. Anderson using pictures copyright by Aris Multimedia Entertainment, Inc., page 44
 Figure 37: *Walt Brown, page 45
 Figure 38: *John J. McIntosh, page 46
 Figure 39: Charles R. Hazard, *Insight on the News*, page 47
 Figure 40: *Ethel R. Nelson. For details see her book, *The Discovery of Genesis*, p. xii, page 48
 Figure 41: *Ark sketch by Walt Brown/photo by U.S. Air Force Academy, page 49
 Figure 42: *Steve Daniels, page 108
 Figure 43: copyright-LANDISCOR INC., page 110
 Figure 44: World Ocean Floor, Bruce C. Heezen and Marie Tharp, 1977, copyright by Marie Tharp 1977, by permission of Marie Tharp, page 112
 Figure 45: *U.S. Navy SEASAT satellite photo, page 113
 Figure 46: *Walt Brown, page 114
 Figure 47: *Bradley W. Anderson, page 115
 Figure 48: *David O. Stevens, page 115
 Figure 49: *John Pinkston and Laura Stern, USGS, page 116
 Figure 50: courtesy Geological Survey of Canada (photo no. GSC180345), page 117
 Figure 51: *Walt Brown, page 119
 Figure 52: illustration by Allen Beechel, page 120
 Figure 53: *Bradley W. Anderson, page 120
 Figure 54: *Bradley W. Anderson, page 121
 Figure 55: *Bradley W. Anderson, page 124
 Figure 56: *NOAA Photo Library, page 125
 Figure 57: *David O. Stevens, page 125
 Figure 58: *Steve Daniels, page 125
 Figure 60: *David O. Stevens, page 128
 Figure 59: Japanese Space Agency (JAXA), page 128
 Figure 62: *Walt Brown, page 129
 Figure 61: *Bradley W. Anderson, page 129
 Figure 63: *Bradley W. Anderson, page 130
 Figure 64: *David O. Stevens, page 131
 Figure 65: *Steve Daniels, page 131
 Figure 66: *Steve Daniels/Bradley W. Anderson, page 132
 Figure 67: *computer animation by Bradley W. Anderson, page 133
 Figure 68: *Bradley W. Anderson, page 133
 Figure 69: *Walt Brown, page 134
 Figure 70: *Walt Brown, page 135
 Figure 71: *David O. Stevens, page 136
 Figure 72: Chile's Paleontological Museum of Caldera, page 137
 Figure 73: *Walt Brown, page 138
 Figure 74: copyright WorldSat International Inc., 1999; www.worldsat.ca; all rights reserved, page 139
 Figure 75: *Walt Brown, page 145
 Figure 76: *Walt Brown, page 145
 Figure 77: *Walt Brown, page 145
 Figure 78: *Bradley W. Anderson, page 146
 Figure 79: *Bradley W. Anderson, page 147
 Figure 80: Walt Brown, page 147
 Figure 81: *Walt Brown, page 148
 Figure 82: *Walt Brown, page 149
 Figure 83: Digital Wisdom, Inc.; inset map by USGS; labels by Walt Brown, page 152
 Figure 84: *photo of Ashley Wilcox by Walt Brown, page 154
 Figure 85: *Walt Brown, page 155
 Figure 86: *drawn by Walt Brown after Satoru Urakawa, page 156
 Figure 87: *Calvin Hamilton, with permission, page 157
 Figure 88: *Walt Brown, page 158
 Figure 89: *Walt Brown, page 160
 Figure 90: *drawn by Walt Brown after Cliff Frohlich, page 161
 Figure 91: *NASA, page 161
 Figure 92: *Walt Brown, page 166
 Figure 93: *Walt Brown, page 170
 Figure 94: *NASA, Jet Propulsion Laboratory, page 171
 Figure 95: *Walt Brown, based on data from "Episodic Tremor and Slip on the Cascadia Subduction Zone," *Science*, 20 June 2003, Vol. 300, p. 1943, page 172
 Figure 96: *Jim McDowell, page 173
 Figure 97: *Jim McDowell, page 173
 Figure 98: *Walt Brown, page 174
 Figure 99: Robert van der Hilst, page 175
 Figure 100: Almy stock photo, page 179
 Figure 101: George W. Housner, page 194
 Figure 102: George W. Housner, page 194
 Figure 103: *Walt Brown and Bradley W. Anderson, page 198
 Figure 104: *Walt Brown, page 199
 Figure 105: *Walt Brown, page 200
 Figure 106: *Bradley W. Anderson, page 202
 Figure 107: *Jim, Sean, and Ryan McDowell, page 203
 Figure 108: *Bradley W. Anderson, page 204
 Figure 109: *Walt Brown, page 205
 Figure 110: *Bradley W. Anderson, page 206
 Figure 111: *Walt Brown, page 206
 Figure 112: *Bradley W. Anderson, page 206
 Figure 114: *Corel Professional Photos, page 207
 Figure 113: *Walt Brown, page 207
 Figure 115: *Walt Brown, page 208
 Figure 116: *Walt Brown, page 208
 Figure 117: *Walt Brown, page 208
 Figure 118: *Walt Brown, page 209
 Figure 119: *Lupus Animation, LLC, page 214
 Figure 120: copyright 2008 TerraMetrics, Inc.; copyright DigitalGlobe; Google Earth; captions and outline by Walt Brown, page 217
 Figure 121: *Walt Brown, page 218
 Figure 122: *Heinrich Balduin Mollhausen, page 219
 Figure 123: R Scott Cherba, website: <http://cherba.com/wcs/features/030420/index.html>, page 220
 Figure 124: *computer-generated map by Bradley W. Anderson, page 222
 Figure 125: *computer-generated illustration by Bradley W. Anderson, page 222
 Figure 126: *U.S. Geological Survey, page 223
 Figure 127: *Walt Brown, page 223
 Figure 128: *Walt Brown, page 223

- Figure 129: Photo by (c) Vadim Aristov—www.aristov.com, page 224
- Figure 130: *Walt Brown, page 225
- Figure 131: *Walt Brown, page 226
- Figure 132: *Walt Brown, page 227
- Figure 133: *Walt Brown, page 229
- Figure 134: *copyright Creatas, 2006, page 230
- Figure 135: *Corel Professional Photos, page 231
- Figure 136: *Lupus Animation, LLC, page 231
- Figure 137: *Walt Brown, page 232
- Figure 138: *courtesy of Imperial Sand Dunes Recreation Area, page 232
- Figure 139: *Walt Brown, page 234
- Figure 140: *Anastasia M. Griffin, page 235
- Figure 141: *Walt Brown, page 235
- Figure 142: *courtesy of Dr. Larry Sobel, page 238
- Figure 143: *The Wave, Coyote Buttes, Arizona*; Symon Byrne, page 239
- Figure 144: *Marine Geoscience Data System, page 241
- Figure 145: *Walt Brown, page 242
- Figure 146: copyright 2008 TerraMetrics, Inc.; copyright DigitalGlobe; Google Earth; captions and outline by Walt Brown, page 246
- Figure 147: Ken Bevis, professor of geology, Hanover college website: intheplaygroundofgiants.comtml, page 247
- Figure 148: *Walt Brown, page 251
- Figure 149: *Walt Brown, page 251
- Figure 150: *Walt Brown, page 253
- Figure 151: *(above) Corel Professional Photos; (below) copyright Churchill & Klehr, page 259
- Figure 152: *National Science Foundation, NOAA, and University of Washington, page 261
- Figure 153: *Corel Professional Photos, page 263
- Figure 154: *Walt Brown, page 264
- Figure 155: *courtesy Zoological Museum of St. Petersburg, page 266
- Figure 156: Natural History Museum, London, page 266
- Figure 157: *map drawn by Bradley W. Anderson, page 268
- Figure 158: *courtesy of Richard B. Firestone et al., page 270
- Figure 160: *N. A. Transehe, "The Siberian Sea Road," *The Geographical Review*, Vol. 15, 1925, p. 375, page 271
- Figure 159: *N. A. Transehe, "The Siberian Sea Road," *The Geographical Review*, Vol. 15, 1925, p. 375, page 271
- Figure 161: *Steve Daniels, page 272
- Figure 162: courtesy of Adrei Sher, page 276
- Figure 163: *B. Willis et al., *Research in China*, Vol. 1 (Washington, D.C.: Carnegie Institution, 1907), page 277
- Figure 164: *Steve Daniels, page 278
- Figure 165: *Steve Daniels, page 279
- Figure 166: *Comet Linear: NASA; All others: PhotoDisk, Vol. 34 Spacescapes, page 300
- Figure 167: *PhotoDisk, Vol. 34, Spacescapes, page 301
- Figure 168: *NASA, page 302
- Figure 169: *NASA, page 303
- Figure 170: *NASA, page 304
- Figure 172: *Walt Brown, page 305
- Figure 171: *Walt Brown, page 305
- Figure 173: *Jim McDowell, page 306
- Figure 174: *Walt Brown, page 307
- Figure 175: *Apollo 16, NASA, page 311
- Figure 176: *Walt Brown, page 316
- Figure 177: *Walt Brown, page 318
- Figure 178: *Artist: Lieve Verschuier, 1680, page 319
- Figure 179: *NASA, page 320
- Figure 180: *NASA/JPL, page 336
- Figure 181: *drawn by Walt Brown after Erik Aspfaug, page 338
- Figure 182: *Walt Brown, page 339
- Figure 183: *Walt Brown, page 339
- Figure 184: ESA, Rosetta Mission to comet 67P, page 340
- Figure 186: *Walt Brown, page 341
- Figure 185: *Walt Brown, page 341
- Figure 187: Marvin Killgore, Southwest Meteorite Laboratory, page 343
- Figure 188: *NASA, page 345
- Figure 189: *NASA. The Cassini Program, page 346
- Figure 190: *ISAS/JAXA, page 348
- Figure 191: *NASA, page 348
- Figure 192: *NASA, David C. Jewitt, page 349
- Figure 193: *Walt Brown, page 349
- Figure 194: *NASA, page 351
- Figure 195: *NASA/JPL/MSSS, page 355
- Figure 196: NASA, New Horizons, page 358
- Figure 197: NASA, New Horizons, page 360
- Figure 198: *drawn by Walt Brown after Trujillo and Sheppard, page 361
- Figure 199: *Walt Brown, page 361
- Figure 200: NASA, New Horizons, page 362
- Figure 201: *U.S. Naval Observatory, page 378
- Figure 202: *Randy Montoya, Sandia National Laboratory, page 378
- Figure 204: *Joshua B. Spencer and Walt Brown, page 381
- Figure 205: *Stanislav Adamenko, page 384
- Figure 206: *Stanislav Adamenko, page 384
- Figure 207: *Walt Brown, page 388
- Figure 208: *drawing by Walt Brown, based on Figure 16 in referenced paper by Paul A. Ramdohr, page 390
- Figure 209: *Walt Brown, page 391
- Figure 210: *Walt Brown, page 391
- Figure 211: *Walt Brown, page 392
- Figure 212: *Walt Brown, page 392
- Figure 213: drawing by Peggy Brown, page 393
- Figure 214: *Walt Brown, page 394
- Figure 215: *Henry W. Miller, *The Paris Gun*, page 395
- Figure 216: *Jim McDowell, page 395
- Figure 217: U.S. Bureau of Ocean Energy Management, page 397
- Figure 218: *NASA, page 404
- Figure 219: photograph by R. Pelisson, Sahara meteorite from Hammada al Hamra Plateau, Libya, page 410
- Figure 220: *redrawn from Briere and Scanlon, Figure 4, U.S. Geological Survey, page 412
- Figure 221: *Jim McDowell, page 413
- Figure 222: *Walt Brown, page 425
- Figure 223: *Bradley W. Anderson, page 434
- Figure 224: *Jim McDowell and Walt Brown, page 437
- Figure 225: *Walt Brown, page 438
- Figure 226: *Walt Brown, page 443
- Figure 228: courtesy of Indiana University, page 445
- Figure 227: NASA, page 445
- Figure 229: NASA, page 446
- Figure 230: *(A) (B) (D) (E) (F) National Optical Astronomy Observatories, W. Schoening/N. Sharp, (C) T. Boroson; composition by Bradley W. Anderson, page 455
- Figure 231: *PhotoDisk, Vol. 34 Spacescapes, page 456
- Figure 232: *National Institute of Standards and Technology, Boulder, CO, page 457
- Figure 233: *NASA, page 462
- Figure 234: *Gerhard Heilmann, *The Origin of Birds*, p. 168, page 464
- Figure 235: *courtesy of N. Chandra Wickramasinghe from *Archaeopteryx: The Primordial Bird*; design by Bradley W. Anderson, page 464
- Figure 236: *courtesy of N. Chandra Wickramasinghe from *Archaeopteryx: The Primordial Bird*, page 465
- Figure 237: *courtesy of N. Chandra Wickramasinghe from *Archaeopteryx: The Primordial Bird*, page 465
- Figure 238: composition by Bradley W. Anderson using T-Rex from the Natural History Museum, London, and bird from Corel Professional Photos, page 466
- Figure 239: *Walt Brown, page 469
- Figure 240: *Walt Brown, page 476
- Figure 241: Walt Brown, page 477
- Figure 242: *Steve Daniels, page 486
- Figure 243: *Walt Brown, page 487
- Figure 244: *Walt Brown, page 491
- Figure 245: Michihimo Yano, page 494
- Figure 246: Adventures Unlimited Press, page 497
- Figure 247: *Walt Brown and Bradley W. Anderson; inset by Donald Wesley Patton, page 504
- Figure 248: *Walt Brown, page 507
- Figure 249: *Bradley W. Anderson and Walt Brown, page 510
- Figure 250: *design by Peggy Brown and Bradley W. Anderson using Corel Professional Photos and photo by Bradley W. Anderson, page 529
- Figure 251: Tom Moore, page 534
- Figure 252: *based on an earlier drawing by George Mulfinger, page 546
- Figure 253: *Bradley W. Anderson, page 550
- Figure 254: *Walt Brown, page 558
- Figure 255: ScienceCartoonsPlus.com, page 559
- Figure 256: The White House, page 565
- Figure 257: *Walt Brown, page 574
- Figure 258: *Walt Brown, page 575
- Figure 259: *Walt Brown, page 576
- Figure 260: *Walt Brown, page 577
- Figure 261: *Walt Brown, page 581
- Figure 262: *Bradley W. Anderson, page 583
- Figure 263: *R. B. Brown, page 587
- Figure 264: *R. B. Brown, page 589
- Figure 265: *Walt Brown, page 593
- Figure 266: *Walt Brown, page 595
- Figure 267: *drawn by Diego Rodriguez based on photo by E. U. Franck, page 598
- Figure 268: *Walt Brown, page 606
- Figure 269: *Walt Brown, page 608

Index

Numerics

19-Mile Fault 251–252
360-day year 592
 revised by flooding of the Nile 185
360-day year of the Persians, Incas, Egyptians, Chinese, Chaldeans, Assyrians, Babylonians, Hebrews, Greeks, Hindus, Romans, Aztecs, Mayas, and Peruvians 185
90°E Lake 150

A

A Whale of a Tale 137
A. S. W. 294–295
A'Hearn, M. F. 326, 329
Aardsma, Gerald E. 458, 483
Abas-Abas, may have located the Ark 46
Abbott, Leon 602
Abel (son of Adam) 554
Abel, David L. 54, 61, 74–75
Abell, George (1927–1983) 97
Abelson, Philip H. 75
Abert squirrels 255
abortion 552
Abraham 483, 485, 505, 525, 554
absolute zero 32, 296, 351, 457, 472, 520
accelerated radioactive decay 102, 404, 406, 408–409, 411, 418, 564, 599–601
accelerator mass spectrometry (AMS) 383, 508
accretion 31, 87, 89, 335, 578, 585, 603
accuracy vs. precision 454, 457, 459
Ackerman, Paul D. 104
acquired characteristics 5, 51
active asteroids 347
Adam 505, 525, 529–531, 533–535, 554–555, 567
Adamenko, Stanislav 384, 408, 420–421
Adams, J. Brad 183
Adams, J. Q. 102
aerobraking 304, 336–337, 346, 348, 369
Africa 37–38, 72–73, 108, 120, 155, 285, 288, 292–293, 494, 497, 527, 534–536
Agafonov, A. V. 417
Agassiz, Louis (1807–1873) 77
age of universe 454–459, 461–463
Agee, Carl B. 182
Ager, Derek V. 98–99
Agarter, S. 509
aging 510, 512
Agrawal, Anurag A. 51
Aitichon, Jean 60
Aitichison, Stewart 255
Akridge, G. Russell 493
Alaska 118, 195, 267, 272, 274–275, 279–280, 283, 285, 288–290, 293, 295, 297
Albee, Arden L. 373–374
albinism 54
Albrecht, Andreas 459
Alcorn, Randy 523, 526
Aldrich, L. T. 421
Alemseged, Zeresenay 73
Aleutian Trench 152, 191
Alexander, H. S. 253
Alexander, Richard D. 551
Alfonsi, Laura 192
Alfvén, Hannes (1908–1995) 328, 332
Algodones Sand Dunes 232
Alice Springs, Australia 207

Allen, John Eliot 252
Aller, Lawrence H. 97
Allmon, Warren D. 299
Alpha Centauri 440
alpha particles 384–385, 387–389, 399, 406–407, 419
Alpher, Ralph A. 429
Alt, David 213
Altamimi, Z. 186
altruism 8, 58–59
Altwegg, Kathrin 309, 330
aluminum ore deposits 600
Alvarez, J. M. 366
Alvin, the deep-sea submersible 169
Alzheimer's disease 511
Amadeus Basin 207
Amazon Canyon 116
amber, fossilization in 12–13, 38, 70, 100
amino acids 14–15, 18, 54, 74, 77, 79–80, 294, 301, 307–309, 311, 317, 321, 330, 510–511
 building blocks for proteins 15
 in meteorites 351
 left-handed 18–19, 75
 measure of genetic distance 77
 right-handed 18
 too complex to evolve 15, 22, 75, 81
amud (Hebrew for pillars) 471
Ampere's Law 418
amphibians 12, 15, 37, 67, 81, 99, 539
anaerobic bacteria 532
Anasazi Indians 43, 209
ancient historians (claimed Ark's existence) 45, 106
Anders, E. 335
Anderson, Bradley W. vi
Anderson, Charles A. 256
Anderson, Don L. 189, 606
Anderson, George E. 210
Andert, T. P. 370
Andes Mountains 133, 170
andesite line 162, 168
Andrews, Brenda J. 82
Andrews-Hanna, Jeffrey C. 331
Aneshansley, Daniel J. 84
angiosperms (flowering plants) 67, 71
angle of repose 366
angular momentum 27, 34–35, 86, 89, 94–96, 148–149, 182, 294, 323, 335, 440, 578–579
animal behavior in humans 551
Anisimova, O. V. 428
anomalies 115, 131, 141, 147–148, 315
Answers in Genesis (AiG) 558, 560–562, 564
Antarctic subsurface lakes 498
Antarctica 116, 125, 141, 150, 281–282, 289, 298, 355, 497–499, 517–518
Anthony, Harold E. 293
anthracite coal 116
antibiotics 7, 53
antibody production 11
antimatter 33–34, 93, 439, 446, 448, 453
Antonacci, Mark 432
Antonucci, Robert 451
ape-men 13, 63, 71
 australopithecine 14, 72–73, 99
 Cro-Magnon man 14
 Heidelberg man 14
 Java man 14, 71–72
 Lucy 14, 72–73
 Narmada man 72
 Neanderthal man 14
 Nebraska man 13–14

Peking man 14
Pittdown man 14
Ramapithecus 14, 73
apes 8, 12, 14, 25, 59, 66, 68, 72–73
aphelions 304–305, 317–318
Apollo spacecraft 26, 326, 331, 580, 583
Appalachian Mountains 133, 158, 208
appendix (human organ) 11, 62
appendix, protection from infection 11
Appennines Mountains of Italy 107
aquifers 129, 200, 225, 238
Arago, Dominique Francois Jean (1786–1853) 315
Ararat Anomaly 47
Archaeopteryx
 not related to modern birds 68, 464, 466, 559
Archaeoraptor, a fraud 467
Archimedes' principle 230
arcs and cusps 152, 165, 173–174, 180
Arctic Circle 136, 267, 270–271, 276, 281, 518
Arctic latitudes 527
Arctic Tern 22
Are some meteorites from Mars? 353
argon 353, 383, 401, 403–404, 409, 421
 excess in comets 307, 328
argon-argon dating 243, 256
Aristotle (384–322 B.C.) 315, 417
Arizona 13, 43, 70, 140, 200, 211, 215–216, 222, 227, 229–231, 234, 236, 244, 250, 252, 255–257, 264, 266, 301, 493–494
Ark of Noah 49–50, 485, 488, 494, 555
 See also Noah's Ark
Ark of the Covenant 107
Armstrong, Carol 70
Armstrong, Harold L. 526
Armstrong, Neil 104
Arnett, Bill 371
Arnold, Carrie 183
Arnold, Chester A. 66
Arp, Halton M. 91–92, 106
Arpachshad (grandson of Noah) 505
Arrhenius, Gustaf 328, 332
arthritis 14
arubbah (Hebrew for floodgates) 492
Aryan people 527
asexual reproduction 21
Ash, Caroline 459
Ash, Richard 431
Ash, Sidney 255
asha (Hebrew for made) 543
Ashworth, Allan C. 150
Asia 115, 136, 138, 150, 187, 190, 270, 274, 279, 281, 285, 292–293, 295, 517, 534
Asimov, Isaac (1920–1992) 56, 104
Asphaug, Erik 87, 327, 365–366
Assyrians, 360-day year 185
asteroids 30, 48, 88, 111, 332–333, 336, 339, 342, 348, 353, 469, 547, 597
 belt 88, 312, 323, 337, 342, 347, 349, 363, 365, 370
 claimed source of space dust 42, 342
 exploded-planet theory 337, 345
 extinctions caused by 123
 failed-planet theory 337, 345
 impacts with Earth 517, 521
 iridium, claimed source of 123
 moons of asteroids 336, 345, 350
 named
 3753 349
 617 Patroclus 350
 Ceres 338, 344, 365, 367–368
 Chariklo 357
 Cybele 344, 367

Hermes 368
Itokawa 348, 373
Menoetius 350
Themis 344, 367
Vesta 367
total mass of all asteroids 320
asthenosphere 174
astronomical unit (AU) 302
Atlantic Ocean 114, 158, 169, 182
atmosphere 507, 518
 insufficient carbon in 14, 262
 of early Earth 14–15, 31, 75, 539
 of Earth 39–40, 42, 125, 260, 278, 280, 282–283, 296, 506–507, 519–522, 539
 of Sun 30
 of Venus 31, 519
 part of biosphere 3
 planetary 102, 519, 533
 pre-flood 539
atomic clocks, time 455–457, 459
atomic mass units (AMU) 379, 399
Atreya, Sushil K. 377, 533
Audouze, J. 95
Auldane, Jeremy 70
Aumann, H. H. 105
Austin, Steven A. 75, 211, 248, 563, 602
Australia 7, 107, 115, 122, 142, 152, 187, 207, 458, 517, 529, 534
australopithecine 14, 72–73, 99
Australopithecus afarensis 14, 73
Austronesian languages 517
Auton, Adam 78
Avogadro's number 426, 512
Axel Heiberg Island 138, 141
Axelrod, Daniel I. 68
axial rift 146–147
axis change 111, 122, 138, 148–149, 547
axis of rotation 149–150
Ayala, Francisco J. 53–54, 65
Ayers Rock, Australia 207–208
Azar, Larry 98
Aztecs, 360-day year 185

B

Babbitt, Bruce 215, 250
Babel, languages multiplied at 515, 536
Babich, Leonid 417, 508
Babylon 536
Babylonians, 360-day year 185
Bacillus 38
background radiation 32, 38, 92, 451, 460
backward orbits 27
backward-spinning planets 27
Bacon, Francis (1561–1626) 121, 567
bacteria 6–7, 12, 18–19, 21–23, 25, 38, 53, 74, 80–81, 84, 100–101, 116, 122, 136, 284, 286, 307, 310, 318, 351, 372, 499, 552–553, 576
 anaerobic 532
 bioluminescence in 25
 cyanobacteria (blue-green algae) 74
 in space 309–310, 312, 320, 330
bacterial motors 22–23, 25, 84
bacterial resistances 7, 53
Bada, Jeffrey L. 372
badal (Hebrew for separate) 522
Baeza, A. Arellano 429
Baffin Island 415, 433
Bahamas Bank 263–264
Bahn, Paul 293–294
Bailey, M. E. 333
Bailey, Vanessa 515

- Baker, Joanne** 370
Bakker, Robert T. 467
Balick, Bruce 96
Ballentine, Chris J. 421
Balsiger, David W. 106
Balter, Michael 72, 467, 536
Bandfield, Joshua L. 372
Bangladesh 495
baptism 555
baqa (Hebrew for burst open) 492, 519, 523
baqia (Hebrew for breaches) 523
barbed canyons 217, 219, 222–225, 228, 237, 240
Barber, D. J. 372
Barbi, Mauricio 101
Barinaga, Marcia 535
Barkana, Rennan 451
Barker, William A. 382, 398, 408, 419
Barnard's Star 513
Barnes, Deborah M. 57
Barnes, Joshua 452
Barnes, Lawrence G. 150
Barnett, Adrian 80
Barnicoat, A. C. 87, 602
Barr, James 537
Barracough, S. H. E. 393
barriers, buffers, and chemical pathways 15, 77
Barrow, John 459
Bartek, Jiri 82
Barth, Amy 70
Barto-Kyriakidis, A. 141
Baryshnikov, G. F. 293
basalt
flood 118, 134, 165–166
on ocean floor 114, 162, 166, 168, 170, 190
photo of 119
Basri, Gibor 514–515
Bass, Arnold 63
Bassler, Bonnie L. 84
Bate, Roger 377
Bates, Robert L. 211, 252, 298
batholiths 390, 401, 414, 424
bats 23, 83
Batten, Roger L. 67, 103
Batygin, Konstantin 363, 377
Baugh, Albert C. 60
Baugh, Carlton 94
Baum, Edward M. 419, 428, 433
Baumgardner, John R. 420, 449, 509, 563–564, 602
Bay of Fundy, Canada 579
Beardsley, Timothy M. 105
beasts of the earth 479
field 479, 539
Beck, Charles B. 67
Beck, William S. 63
Beckenbach, Andrew T. 100
Becker, George F. 74
Becquerel, Henri (1852–1908) 421
Beers, Timothy C. 93, 433
bees 13, 21
beetles 23, 84
Behe, Michael J. 53, 55, 76–77, 82, 84
Behemoth 493, 495
Behling, Ed (Ark hunter) 107
Bell, Robin E. 150, 499
Bellissent-Funel, M. C. 144
Benard cells 191, 360
Benioff zones 155, 159, 161–162, 166, 170, 178, 183–184
Benkendorf mammoth 272, 287
Bennett, Charles H. 61
Bennett, Willard H. 393, 420, 426
bent rocks, folded mountains 117
Benton, Thomas H. 99
benzene ring, discovery of 438
Berezovka mammoth 266, 273–275, 277, 282, 285–287, 295–296
Berg, Howard C. 84
Berger, Eve 330
Bergman, Jerry 53, 62, 69
Bering Strait 274, 279, 289–290, 517
Berk, J. Edward 62
Berkley, John L. 371
Berlitz, Charles (1914–2003) 106, 138, 151
Berman, Bob 331
Bermuda Rise 167
Bernstein, Max P. 325
Bertsch, George F. 428
beryllium 32, 383, 401, 420
beta decay 382, 384, 387–388, 419, 421
Bethe, Hans 429
Bethell, Tom 77
Beus, Stanley S. 250–251
Bhattacharjee, Yudhijit 429, 463
Bible References
Genesis 1 521, 525, 538–540, 543–544
Genesis 1:1 522, 526, 529–531, 538, 554–555, 569
Genesis 1:2 470, 488, 529–531, 538, 543
Genesis 1:3 442, 530, 538, 543, 554
Genesis 1:4 460
Genesis 1:4–5 538
Genesis 1:6 555
Genesis 1:6–7 470, 488, 521, 539
Genesis 1:6–8 518, 521–522, 539
Genesis 1:7 522, 555
Genesis 1:8 471, 522–523, 538
Genesis 1:9 470, 476, 488, 522, 538–539, 543
Genesis 1:10 470, 554
Genesis 1:11 539, 554
Genesis 1:11–12 479, 539
Genesis 1:11–13 539
Genesis 1:11–23 538, 541
Genesis 1:12–16 539
Genesis 1:13 538
Genesis 1:14 519–520, 522, 525, 533
Genesis 1:14–15 522, 539
Genesis 1:14–16 489, 586
Genesis 1:14–17 526
Genesis 1:14–18 530
Genesis 1:14–19 538
Genesis 1:14–20 521
Genesis 1:16 439, 442, 538, 543
Genesis 1:17 522
Genesis 1:19 538
Genesis 1:20–21 539
Genesis 1:20–22 538
Genesis 1:20–23 539
Genesis 1:20–24 539
Genesis 1:20–25 539
Genesis 1:20–30 539
Genesis 1:21 544, 554
Genesis 1:21–22 539
Genesis 1:22 501
Genesis 1:23 538
Genesis 1:24 539, 544, 554
Genesis 1:24–25 479
Genesis 1:26 540–541
Genesis 1:26–30 540, 554
Genesis 1:27 479, 554
Genesis 1:28 474, 501, 531
Genesis 1:28–30 540
Genesis 1:29–30 540–541, 545
Genesis 1:30 539–540, 542
Genesis 1:31 381, 454, 469, 472, 476, 488, 530, 538–539, 541–542, 544, 586, 592, 602
Genesis 1–2 538
Genesis 1–3 538
Genesis 1–11 436–437, 537, 541, 553
Genesis 2 535
Genesis 2:1 554–555
Genesis 2:1–3 539
Genesis 2:2 538
Genesis 2:2–3 554
Genesis 2:4 554–555
Genesis 2:4–25 537–538
Genesis 2:5–6 475, 477–479, 488
Genesis 2:6 472, 523
Genesis 2:7 539–540, 544, 554
Genesis 2:9 555
Genesis 2:10–14 475, 478, 535
Genesis 2:14 535
Genesis 2:15 540
Genesis 2:16 554
Genesis 2:17 539, 541–542, 554
Genesis 2:18 554
Genesis 2:18–24 540
Genesis 2:19–20 479
Genesis 2:20 539–540
Genesis 2:21–23 540
Genesis 2:22 539, 554
Genesis 2:23 554
Genesis 2:24 540, 554
Genesis 3 474, 539, 541
Genesis 3:1 555
Genesis 3:1–24 541
Genesis 3:4 542, 554
Genesis 3:5 554
Genesis 3:8–9 522
Genesis 3:13 554
Genesis 3:14 555
Genesis 3:14–24 541
Genesis 3:15 555
Genesis 3:16 540, 554–555
Genesis 3:16–19 538, 541–542
Genesis 3:17 554–555
Genesis 3:17–18 541
Genesis 3:18 479, 554–555
Genesis 3:19 554–555
Genesis 3:20 540
Genesis 3:22 542, 555
Genesis 3:23 554
Genesis 4 2 540
Genesis 4:3–5 554
Genesis 4:4 554
Genesis 4:8 554–555
Genesis 4:10 554
Genesis 4:16 555
Genesis 4:21–22 540–541, 602
Genesis 4:25 555
Genesis 5 505, 540–541
Genesis 5:1 540, 554–555
Genesis 5:2 554
Genesis 5:3 540, 554–555
Genesis 5:4 541
Genesis 5:5–7 538
Genesis 5:15 540
Genesis 5:21–24 554
Genesis 5:32 505, 512
Genesis 6 1 501, 554
Genesis 6:5 469, 474, 501
Genesis 6:5–12 488
Genesis 6:7 501
Genesis 6:8 555
Genesis 6:11 473–474, 501
Genesis 6:13 490, 538
Genesis 6:14–16 540, 555
Genesis 6:17 490, 538
Genesis 6–8 538
Genesis 7 1 474, 485
Genesis 7:1–24 554–555
Genesis 7:4 485, 488
Genesis 7:4–23 538
Genesis 7:10 485, 554
Genesis 7:11 472, 485, 488, 490, 492, 518–519, 538, 554, 601
Genesis 7:11–12 489, 519
Genesis 7:12 485, 488–489, 525
Genesis 7:13 485
Genesis 7:13–24 555
Genesis 7:17 485, 555
Genesis 7:19 485
Genesis 7:19–20 538
Genesis 7:19–24 488, 524–525
Genesis 7:20 472–473, 487
Genesis 7:21–23 538
Genesis 7:24 485, 487, 489–490, 538
Genesis 8 1 487
Genesis 8:1–4 488
Genesis 8:1–19 555
Genesis 8:1–22 554
Genesis 8:2 489, 492, 519, 525, 582
Genesis 8:3 502
Genesis 8:3–5 503
Genesis 8:4 490
Genesis 8:5 485
Genesis 8:7 485
Genesis 8:8–9 485
Genesis 8:10–11 485
Genesis 8:12 485
Genesis 8:13–14 485
Genesis 8:14 538
Genesis 8:15–19 485, 488
Genesis 8:17 501
Genesis 9 1 501, 516
Genesis 9:2–3 554
Genesis 9:3 540
Genesis 9:7 501
Genesis 9:11 490, 538
Genesis 9:11–25 538
Genesis 9:12–17 475
Genesis 9:15 492
Genesis 9:24 505
Genesis 10 499
Genesis 10:8–10 517
Genesis 10:21 505
Genesis 10:25 515–516, 554
Genesis 10–11 529
Genesis 11 541
Genesis 11:1–9 515, 536, 540
Genesis 11:3–6 540
Genesis 11:4–9 516
Genesis 11:6–19 541
Genesis 11:10 554
Genesis 11:26 505
Genesis 11:32 505
Genesis 12 4 505
Genesis 15:10 522
Genesis 17 2 485
Genesis 26 4 522
Genesis 27:28 522
Genesis 28:12 522
Genesis 35:11 501
Genesis 49:25 522
Exodus 9:18 489
Exodus 9:24 489–490
Exodus 12:40 483
Exodus 12:37 484
Exodus 20:4 493
Exodus 20:8–11 540
Exodus 20:11 439, 530, 533, 538–539, 541
Exodus 31:17 539
Leviticus 18:6–18 544
Numbers 16:31 485, 492, 519
Numbers 16:38 523
Numbers 16:39 523
Deuteronomy 26:15 522
Joshua 10:13 490, 501
I Samuel 15:29 569
II Samuel 1:18 490, 501
II Samuel 21:10 479
I Chronicles 1 540
I Chronicles 1:19 515–516
Job 9 8 439
Job 38 4 476
Job 38:4–6 471
Job 38:8–11 471, 489
Job 38:16 489
Job 38:25 516

- Job 40:15** 292
Job 40:15–18 493
Job 40:15–41:34 539
Psalm 8: 5 540
Psalm 8: 7 479
Psalm 18: 7–15 490
Psalm 18:14 490
Psalm 18:15 472, 489
Psalm 19: 1 3, 446, 449, 538
Psalm 24: 2 470, 473, 489, 538
Psalm 33: 6 538
Psalm 33: 6–9 539
Psalm 33: 7 489
Psalm 74:14 495
Psalm 75: 3 471
Psalm 78:15 485
Psalm 90: 4 538
Psalm 104: 1–4 492
Psalm 104: 2 439, 443
Psalm 104: 3 470, 473, 476, 489, 538
Psalm 104: 5 471, 476, 479
Psalm 104: 6–9 3, 489, 538
Psalm 104:26 495
Psalm 136: 5–9 521
Psalm 136: 6 473, 489, 538
Psalm 139:14 3
Psalm 148: 5 539
Proverbs 3:19–20 489, 492, 519
Proverbs 8:22–29 479, 489
Isaiah 11: 6–9 541
Isaiah 24:18–20 479, 490
Isaiah 27: 1 495
Isaiah 34:15 485, 492, 519
Isaiah 40:21 479
Isaiah 40:22 439
Isaiah 42: 5 439, 522
Isaiah 44:24 439
Isaiah 45:12 439
Isaiah 45:18 530
Isaiah 48:13 439
Isaiah 51: 3 540
Isaiah 51:13 439, 479
Isaiah 59: 5 485, 492, 519
Jeremiah 10:12 439
Jeremiah 31:37 479
Jeremiah 51:15 439
Ezekiel 13:11–13 485, 519
Ezekiel 28:13 540
Ezekiel 36:35–13 540
Joel 2: 3 540
Micah 1: 4 492, 519
Micah 6: 2 479
Zechariah 12: 1 439
Zechariah 14: 4 492, 519
Malachi 3: 6 569
Matthew 1:21 555
Matthew 5: 1–12 541
Matthew 12:40 541
Matthew 15:8–9 484
Matthew 19: 4 540, 554
Matthew 19: 4–5 537
Matthew 19: 5–6 554
Matthew 23:35 554
Matthew 24 541
Matthew 24:21 538
Matthew 24:37–39 530, 554
Matthew 25:32–46 541
Matthew 28:19–20 555
Mark 2:27 540
Mark 8: 3 541
Mark 10: 6 530, 540, 554
Mark 10: 7 554
Mark 13: 8 490
Mark 13:19 538, 554
Mark 24: 7 490
Luke 3:23–38 540
Luke 3:34–36 554
Luke 3:36–37 505
Luke 3:36–38 554
Luke 3:38 540
Luke 11:50–51 540
Luke 11:51 490, 554
Luke 17:26–27 530
Luke 17:27 538, 554
Luke 23:55 545
Luke 24:39 545
John 1: 1 538, 569
John 1: 1–3 554
John 1: 3 437, 541
John 3: 1–12 541
John 3:16 541
John 5:46–47 437, 541
John 6:53 541
John 8:44 540, 554
John 10: 9 555
John 14: 2 541
John 14: 2–3 555
John 14: 6 541
John 17:17 541
Acts 7: 4 483, 505
Acts 7: 6 484
Acts 14:15 437, 554
Acts 17:24 554
Acts 17:24–28 437
Acts 17:26 540
Romans 1:20 474, 537, 540, 554
Romans 4:17 554
Romans 5:12 533, 539–542, 554
Romans 5:14–15 541
Romans 5:14–19 554
Romans 6:23 541
Romans 8:10 542
Romans 8:11 545
Romans 8:18–22 541
Romans 8:20–22 542, 554
Romans 8:22 533
I Corinthians 5:16 554
I Corinthians 11: 3 554
I Corinthians 11: 7 554
I Corinthians 11: 8 540, 554
I Corinthians 11: 8–9 540
I Corinthians 11: 9 554
I Corinthians 15:21 539, 541
I Corinthians 15:21–22 540–542, 554
I Corinthians 15:38–39 554
I Corinthians 15:39 539
I Corinthians 15:45 541–542, 554
I Corinthians 15:45–47 540
I Corinthians 15:47 554
II Corinthians 4: 6 554
II Corinthians 11: 3 554
Ephesians 3: 9 554
Ephesians 5:30–31 554
Colossians 1:16 437, 538, 554
Colossians 3:10 554
I Timothy 2:13–14 540, 554
I Timothy 2:14 554
I Timothy 4: 4 554
Hebrews 1:10 554
Hebrews 2: 7–8 554
Hebrews 4: 1–11 539
Hebrews 4: 3 554
Hebrews 4: 4 554
Hebrews 4:10 554
Hebrews 6:17 569
Hebrews 11: 3 538, 554
Hebrews 11: 4 554
Hebrews 11: 5 505, 554
Hebrews 11: 7 554
Hebrews 12:24 554
James 1:17 569
James 3: 9 555
I Peter 3:20 538, 555
I Peter 3:20–21 555
II Peter 2: 5 538, 555
II Peter 3: 3–6 470, 538
II Peter 3: 4–5 555
II Peter 3: 5 470, 476, 489
II Peter 3: 5–6 521
II Peter 3: 6 538, 555
II Peter 3: 7 538
II Peter 3: 8 538
II Peter 3:10 538
II Peter 3:12 538
I John 3: 8 555
I John 3:12 555
Jude 11 555
Jude 14 555
Revelation 1: 8 569
Revelation 2: 7 555
Revelation 3:14 555
Revelation 4:11 555
Revelation 10: 6 555
Revelation 14: 7 555
Revelation 20: 2 555
Revelation 21: 1 555
Revelation 21: 1–4 542
Revelation 21: 4 555
Revelation 21: 6 569
Revelation 22: 2 555
Revelation 22: 2–3 541
Revelation 22: 3 555
Revelation 22:13 569
Revelation 22:14 555
biblical chronology 482
Bickerton, Derek 60
Bidahochi Formation 256
Bieler, A. 330
big bang 9, 32–34, 61–62, 83, 90–93, 95, 97, 393, 398–401, 411–412, 415–416, 428–429, 449, 451, 455, 459–462, 538, 549
big roll 136, 138, 148–149, 278, 281, 494
Billingsley, George H. 254, 257
binary stars 34, 95, 440, 458, 513–515
binding energy 379–382, 388, 400, 427
Binzel, R. P. 368
biochemistry 58, 77
biodiversity 7
biogenesis 5, 51
biogenetic law 63
bioluminescence 25
birds 6, 12, 23, 67, 270, 272, 286, 291, 464–467, 485, 539
Archaeopteryx 464
Arctic Tern 22
finches 7
flight 10, 25
how to fossilize 465
hummingbird 23, 466
migration 22
modern 467
origin of 67, 464–467, 539
Birdsell, J. B. 74
Birney, Ewan 80
Bishop, Edwin V. 105
Bishop, J. R. 426
Black Canyon of the Gunnison 133–135
black holes 34–36, 94, 96, 439–441, 443–444, 451–452, 461–462
Black Sea 140, 151
black smokers 111, 121, 124–125, 130, 148, 547
black-body radiation 447, 460–461
Blackburn, Quinn A. 141
Blackwelder, Eliot (1880–1969) 221, 237, 244, 251–252
Bland, Philip 365
Blatt, Harvey 142, 266
blind test 415, 432, 508
Block, Douglas A. i. 208
Block, Myron J. 191
blood 15, 21
Bloxham, Jeremy 192
Blyth, Edward (1810–1873) 52, 85, 211
Bobrovnikoff, N. T. 104, 332
Bock, Walter J. 63
Bode, Johann (1747–1826) 332
Bode's law 312, 332
Bohlin, Raymond G. 52
Bolin, Bert 266
Bollinger, R. Randal 62
bombardier beetle 23, 84
Book Cliffs 225, 236, 253, 256
Booker, John R. 191
Boone, Charles 82
boron 32, 383, 401, 420
Borucki, Monica K. 100
Borucki, William 514
Bosch, Fritz 382–383, 398, 408, 419
Bose, A. 69, 71
Bosporus (strait) 140, 151
Boswell, Evelyn 101
Bottke, W. F. 364
Bouchon, Michel 143
Bouckaert, Remco 535
Bougainville Trench 152
Bouger, Pierre 148
Boule, Marcellin 72
bounded variation 6, 52
Bouse Formation 250
Bousselot, Karen 525
Bouw, Gerardus D. 106
Bouwens, Rychar 452
Bowden, Malcolm 63, 71–74, 545
Bowditch, Nathaniel 327
Bower, Bruce 73, 77, 213, 517
Bowie, Walter Russell 474, 512
Boyarhuk, Kirill 188
Boyce, Jeremy W. 331
Boyd, Steven W. 602
Boyle, Robert (1627–1691) 567
Bozarth, G. Richard 544
Brace, C. L. 72
brachiopods 12
Bradley, David 61, 81
Braga-Ribas, F. 376
Brahe, Tycho (1546–1601) 315
Brahic, Catherine 143, 428
Braille 8
brain 7, 9, 23–25, 55–57, 60, 72, 84–85, 99
branching ratios 409
Brand, Leonard R. 211
Brandt, John C. 95
Branley, Franklyn M. 368
Brauer, Oscar L. 82
breached dam
“Lake California” 140
Black Sea, Bosporus, Dardanelles 140
Grand Canyon 140–257
Kashmir 139
Mediterranean “Lake” and Strait of Gibraltar 140
breakdown, electrical 378, 390–391, 425
breaking continents apart 515
Brecher, Kenneth 459
Breed, Carol S. 252
breeding experiments 4, 6, 52
bremstrahlung radiation 390, 398, 400, 404, 411, 425–426, 430
Bretz, J Harlen (1882–1981) 221, 248
Brewer, Gregory J. 77
Brewer, Peter G. 103
Brewster, David 102
Breyne, John 292
Briere, Peter R. 431
Bright Angel Fault 227, 252
Bright, Richard C. 106
Brinkmann, R. T. 75
bristlecone pine, age of 509
British Columbia 117
British Museum (Natural History) 71, 464, 466
Britt, D. T. 364
brittlestar 56
Broderick, Avery E. 452

- Brooks Daniel** 53
Brooks, J. 74
Brosche, P. 579
brown dwarfs 35
Brown, Julian 459
Brown, Mike 86, 361, 363, 375, 377
Brown, Peggy vi
Brown, R. B. 77, 359, 377, 586
Brown, Robert H. 432, 458, 509
Browne, J. B. 102
Brownlee, Donald E. 431, 585
Brownlee, Robert R. 97
Brownlee, Shannon 82
Brush, Stephen G. 85
Bruun, Anton F. 182
Bryan, Victoria 325
Bryce National Park 227, 250
Bryce, James (searching for Ark) 45
Bryson, James F. J. 367
Buchanan, John 102
Buck, W. Roger 184, 189
buckling of a plate on an elastic foundation 130, 228
Budge, E. A. Wallis 474
Buffett, Bruce 193
Bullard, Edward 120–121
Burbidge, E. Margaret 91, 414, 420, 429, 432
Burbidge, Geoffrey R. 91, 97, 106, 414
Burdick, Clifford (1894–1992) 69, 204, 212
Burke, Ann C. 67
burnout (a boiling phenomenon) 394
Burns, Joseph A. 376
Burrows, Wes 536
Busch, Lloyd Earnest 420
butterflies 19–20, 22, 81
buttes 228–232, 236, 247
Byrd, Robert 551
Byrne, Shane 374
- C**
- Caesar, Julius** 484
Cahn, Jonathan 556
Cain's wife 541
Cainan 505
Calaveras skull 74
calcium carbonate 56, 119–234, 259–266
Calder, Nigel 326
California's Imperial Sand Dunes 232, 242, 250
Callahan, Michael 372
Callaway, Ewen 100, 536
Calvert, Frank 102
Cambrian 12, 67–71, 98–99, 203, 207
Cambrian explosion 12, 68–69, 71, 203
Cameron, A. G. W. 431
Campbell, Philip 87, 188, 191, 368, 450, 497
Campins, Humberto 329, 367
Camps, P. 141
Canada 69, 117, 600
canals on Mars 353
Cann, Rebecca L. 100, 535
Cano, Raul J. 100
canopy theory 109, 294, 518–526, 563
 arguments for 518
 key Hebrew words for 521
 scientific arguments against 519
Cantwell, J. C. 295
Canup, Robin M. 86, 89
Canyon de Chelly 229
canyons 489
 Amazon Canyon 116
 barbed 217, 219, 222–225, 228, 237, 240
 Black Canyon of the Gunnison 133–135
 Bryce Canyon 206
 Canyon de Chelly 229
 Congo Canyon 116
 continental canyons 116, 488
 formation of 138
 Ganges Canyon 116
 Grand Canyon 3, 12–13, 38, 48, 69–71, 110–111, 114, 116, 124, 133, 202–257, 264, 547
 Hidden Canyon 256
 Hobble Canyon 256
 Hudson Canyon 116
 Indus Canyon 116
 Marble Canyon 216–217, 219, 223–226, 228, 237, 239–240, 250–251, 253, 255
 Mid-Ocean Canyon 141
 North Canyon 225
 Oak Creek Canyon 227
 Pierce Canyon 250
 Pigeon Canyon 256
 Rider Canyon 251–252
 side canyons in the Grand Canyon 217, 219
 slot 217, 219, 237–238, 240, 242, 250
 submarine canyons 48, 111, 116, 136, 169, 182, 196, 241, 256, 488, 516, 547
 V-shaped canyons 116
Capaccioni, F. 325
Caplan-Auerbach, Jacqueline 190
capture, requirements for 327
captures in space 303–304, 326, 336
carbon 14, 74–75
 carbon-12 506–508
 carbon-14 380, 432, 506–508, 510
 distribution on earth 262
 in atmosphere 14
 in limestone 119, 260
 in the most distant stars 462
 sedimentary distribution of 75
carbon dioxide 31, 89, 260, 262, 265, 348, 497, 506, 519
Caribbean 260
Carilli, Chris 453
Carlsbad Caverns 263
Carnot engines 361, 377
Carpenter, Frank M. 70
Carr, Bernard 93
Carrans, Ian James 211
Carrigan, Charles R. 141, 193
Carrington, Damian 186
Carslaw, H. S. 421
Carswell, R. F. 463
Carter, Brent 562
Carter, J. 333
Cartlidge, Edwin 566
Cartmill, Matt 73
Cascade Mountains 136, 225
Cassé, M. 420, 432
Cassen, P. 596
Cassini spacecraft 346, 370, 376, 595
Cassuto, Umberto 522, 525
Castelvecchi, Davide 419, 451
Castenedolo skeleton 14, 73
Castor, Stephen B. 250
catastrophic plate tectonic theory 109, 563–564
Catley-Carlson, Margaret 211
Catling, David C. 373
Cave, A. J. E. 73
caverns 218–219, 222, 237, 251
caves, formation of 260
Caylor, George V. 78
cellulose in space 309–310, 312, 330
cementing agents 208, 254
 limestone 260, 265
 silica 126, 207, 231, 238, 265
 censorship 567
centaurs 357, 363–364
Central America 120, 213
Central Intelligence Agency (CIA) 47
centrifugal force 131, 520–521
Ceres 337–338, 344–345, 365, 367–368
Cesari, Francesca 328
cesium-133 456
Chabot, Nancy L. 326
Chadwick, Arthur V. 203, 212
Chaffin, Eugene F. 602
Chakoumakos, Bryan C. 424
Chaldeans, 360-day year 185
chalk 263, 266
Chalmers, Thomas (1780–1847) 530
Chamberlain, Joseph W. 102
Chamberlin, Thomas Chrowder (1843–1928) 178, 180, 192, 487, 513
Chandrasekharan, H. 426
Chang, Emmy T. Y. 141
Chang, Kenneth 421
Channeled Scablands 221
Chao, B. Fong 187
Chapman, Robert D. 328
Charig, Alan 466
Charles B. Hunt proposal for the Grand Canyon 222
Chatterjee, S. 186
Chatterton, Brian 56
Chekunov, A. V. 178, 191
Chemehuevi Formation 256
chemical elements
 heavy elements in earliest stars 25, 34, 462
 required for life 14–15, 74, 533, 538
chemical elements (production of) required for life 109
chemical evolution theory 393–401
chemistry 15, 51, 73–74, 81, 83, 465, 549
 of comets 311
 of limestone 260
Chen, Jun-yuan 69
Cherfas, Jeremy 73, 100, 293
chert, formation of 151
Chicurel, Marina 52
Chicxulub, Mexico 123, 143
Chien, Paul 69
childbirth 540
chimpanzee DNA 17, 77, 534
chimpanzees 8, 13–14, 16, 59, 68, 71, 77, 536, 553
China 67, 69, 107, 138, 142, 275, 277, 292, 297, 466, 495, 529
Chinese
 360-day year 185
 pictographs 48, 107
 report of sky sinking toward the north 138
Chinle, Arizona 229
Cho, Adrian 94, 451–452
Chocolate Cliffs 225
Chocolate Mountains 233
Choi, D. R. 187
Choi, Harry Y. 212
Chomsky, Noam 60
chondrules 351, 368, 409–410, 430–431, 474
chordates 69
Chown, Marcus 92
Christensen, Ulrich 189
Christian, John T. 210
Christopher Columbus 497
chronology of flood year 485, 489
chuppah (Hebrew for canopy) 522
Chyba, Christopher 90
Cimatti, A. 453
Ciochon, Russell L. 71
circular reasoning 36, 98
Cirlin, E. H. 431
civilization 533
Clairaut, Alexis-Claude (1713–1765) 315
Clark, Andrew G. 512
Clark, Austin H. 58
Clark, Benton 333
Clark, Marlyn E. 57
Clauser, Christoph 430
Clement, Bradford 190
Clery, Daniel 80, 89, 330, 375, 514
cliffs of Normandy and Dover 299
climatic changes 123
Cline, David B. 94, 453
Clinton, William Jefferson 353
clotting, blood 15
Cloud, Preston Eccelle Jr. (1912–1991) 64, 68, 70
Clube, Victor 335
cluster decay 506
cluster radioactivity 419, 508
Clutton-Brock, Tim 59
CMB (cosmic microwave background) radiation 32, 92, 400, 416, 451, 455, 460, 509
coal
 anthracite, high grade 116
 balls 13
 beds 13, 103, 202
 cytothems 199
 formation of 48, 111, 116, 130, 138, 260, 531, 547
 formations 48, 74, 103, 111, 116, 260, 283–284, 508, 547
 fossils in 38
 human artifacts in 39, 102
 in Antarctica 136
 under Hopi Lake 235
Coates, J. 69, 71
Coble, L. S. 67
Cocke, W. John 459
cockpit, instruments 22
Cockrum, E. Lendell 62
Coconino Sandstone 200, 202, 208, 211
cocoon 19
Cocos Plate 256
codes and programs in DNA 9
codons 60–61
Coe, R. S. 141
Coelacanth fish 37, 98–99
Coffin, Harold G. 64
Coffin, M. F. 187
Colbert, Edwin H. 70
Colby, William, directed CIA 47
cold repacking 398
cold-blooded 25
Cole, Donald i
Cole, G. H. A. 105
Coleman, Loren 326
Coles, Peter 90, 92
Colinvaux, Paul A. 295–296
Collard, Mark 71–72
colliding galaxies 443
Collins, Lorence G. 389, 424
collisions, required if
 planets evolved 29, 84
 proteins evolved 15
Colorado 140, 201
Colorado Creek mammoths 269, 284, 293, 298
Colorado Plateau 119–120, 216, 220–222, 224–226, 234, 236, 238–240, 242–245, 252, 256
Colorado River 110, 203, 214–216, 218, 222, 224–225, 233, 241–242, 248
Columbia Plateau 136, 225
comets 34, 42, 88, 103–105, 111, 123–124,

- 138, 300, 328, 337–338, 348, 374, 469, 482, 525, 547, 597
348
coma 302
composition 28, 306, 314
chemistry 311
crystalline dust (olivine) in 308, 310, 314, 329
heavy hydrogen 34, 310–313, 315, 317, 321, 330, 400, 411, 416
methane, ethane 307, 317, 325
organic matter 301, 310, 312, 315, 317, 325–326, 330
water 301, 314
density of 319
extinctions by 123
fear of 302, 319
formation mechanism 303–304, 310
gravity's effect on 302–306
Jupiter's family 304–305, 310–312, 315, 317, 327
mass of 319
meteors associated with 315
named comets
Great Comet of 1680 319
Hale-Bopp 86, 300, 325, 328–329
Halley 300, 302, 325, 327, 330, 334, 482–484
Hartley 2 308
Herschel-Rigollet 316, 334
Hyakutake 325, 329
Ikeya-Seki 300
Ikeya-Zhang 316
ISON 317, 319
Kohoutek 300
Kreutz Sungrazers 319
LINEAR 300
Shoemaker-Levy 9 304
Swift-Tuttle 483–484
Tempel 1 86, 308, 318, 326
West 300
Wild 2 308
not created 324, 469
nucleus 302–304, 307, 310, 314–315
Oort cloud theory 307, 327, 334–335
orbit
direction (prograde, retrograde) 304–306, 310, 312, 315, 317, 321–322, 324, 327
inclination 305, 310
types 315
elliptical 304–305, 307, 312, 327
intermediate-period 305
long-period 305, 328
near-parabolic 306–307, 312, 314
short-period 305, 312, 327
hyperbolic 305, 307, 312, 328
parabolic 305
small 42, 104, 310–312, 315, 318
strange pairs 317, 334
tail 28, 302
tidal effects on comets 303, 322
two separate populations 310, 317
young 42, 104
Comins, Neil F. 429
common ancestor 11, 62
common designer 10, 62, 466
communication among bacteria 23, 84
communism 551
complex organism 6, 25, 83
complex organs 7, 55, 58
complexity 4–7, 15, 52, 55–56, 61, 69, 76, 549, 567
Complexity of life rules out macroevolution. 14
compression event 131, 133, 135–138, 149–150, 185, 202–203, 206–207, 210, 224, 243, 406–408, 414, 418, 473, 488, 492
compression of rock 117
Compsognathus 464, 466–467
concrete tank, floating 194
condensation nuclei 477
Congo Canyon 116
Congo, reports of living dinosaurs 494
Congress of the United States 567
consequence of the flood 469
conservation of
angular momentum 27, 148–149, 154, 178, 440, 442, 576, 578
energy 32, 306
Constantinople 497
Constitution of the United States 567
contact binaries 357–358
contact binary 358
continental
erosion 40, 103
shelves 48, 111–112, 114–115, 138, 547
slopes 48, 111–112, 114–115, 136, 138, 517, 547
Continental Divide 209
continental-drift phase 130–133, 136, 138, 158
convection cells 162, 173
convection of heat 280
convergent evolution 10
Cook, Jason C. 375
Cook, Melvin A. (1911–1989) 99, 102–103, 383, 420, 507, 509
Cook, Terri 602
Cook, William J. 95
Cooper, Bill 499
Cooper, George 371, 431
Coppedge, James F. 81, 83
copper ore bodies 600
Coptic language 516
coral reefs 97, 169
deposits 516
fossils in Cambrian 12
growth rates 37, 97, 190, 262
Corbin, B. J. 106
Corcoran, Thomas H. 333
Cordiner, M. A. 325
core of the Earth 118, 146, 149, 155, 159, 161, 167, 183–185, 189, 603–605
Corliss, William R. 94, 102, 189, 332, 423, 453
Corner, E. J. H. 66, 69
Cornuke, Robert 107
Corti, organ of 62
Cosgrove, Mark P. 60
cosmic microwave background radiation 92
cosmic microwave background radiation (CMB) 400, 416, 451, 455, 460–461, 509
cosmogenic dating 243, 256
Coulomb force 382–383, 414
counterslab, fossil 464–465
Cousins, Frank W. 73–74
Couzin-Frankel, Jennifer 512
Covault, Craig 371
Cowan, George A. 422, 430
Cowan, John 463
Cowen, Ron 35, 87–88, 91–94, 96, 104–105, 329–330, 333, 335, 367, 370–372, 375–377, 450, 453, 458, 461, 514–515, 602
Cowie, Lennox L. 95
coyote 50, 527
Crab Nebula 43
cracks
trough-shaped 147
V-shaped 147
cracks in Earth's crust 118, 125, 129, 134–135, 143, 146–147, 161, 185
Craig, H. 426
crater ages, as a test of comet theories 312
crater creep 40, 103
craters, impact 123, 143, 301–302, 310–312, 315, 318, 320, 322–323, 331, 341, 353, 356, 365, 373, 583
craters, young 40
creation 9, 14–15, 20, 22, 30, 32, 34, 90, 546, 567
creation definition 549
creation in the classroom 548
Creation Ministries International 561
creation, date of 482, 484
creationism, a word to avoid 556
creep, of solid materials 40, 134
Crelin, Edmund S. 60
Cremo, Michael A. 99
Crick, Francis (1916–2004) 75
criteria for evaluating theories 123
critical point (critical temperature, critical pressure) 105, 124–127, 130, 145, 261, 472, 598, 602
critical thinking skills 315, 548
Crockett, Christopher 93, 376–377, 451–452
Cro-Magnon man 14
Cromie, William J. 193
Crookes, William 339
Cross, Richard L. 84
cross-bedded sandstone 195, 207–208
crossover density and depth 156–157, 161
Crouse, Bill 106
Crow, James F. 54
Cruikshank, Dale P. 329
crustaceans 25, 81
Cruz, Maria 331
cubanite (a mineral) 308, 311
Cummings, Violet M. 106
Cuozzo, Jack 73
Curie point 147
Custance, Arthur C. (1910–1985) 59, 531, 544
Cutler, Alan 107
cut-off problem 448
Cuvier, Georges (1769 – 1832) 299
Cuzzi, Jeffrey N. 88
cyanobacteria 74
Cybele 344, 367
cyclothems 199, 202
Cyr, Donald L. 524
cytochrome c 15, 77
-
- D**
- D'Argenio, Bruno** 372
da Vinci, Leonardo (1452–1519) 107
Dactyl, moon of asteroid Ida 336
Dale, Christopher W. 185
Dall, W. H. 293, 295
Dallegge, Todd A. 256
Dalrymple, G. Brent 420
Dalton, Rex 74, 143
Daly, Reginald A. 372
Dana, James Dwight (1813–1895) 242
Danes, Z. F. 103
Danish Galathea Expedition 182
Dansgaard, W. 142
Dardanelles (strait) 140, 151
dark matter, dark energy 43, 94, 106, 142, 448
Darwin, Charles Robert (1809–1882) 5, 7, 23, 25, 52–53, 57–58, 62, 64–65, 67–68, 81, 84–85, 136, 178, 199, 296, 464, 473, 529, 537, 552
Darwin, Francis (1848–1925) 57
dating techniques
assumptions 36, 43
evolutionary 39
index fossils 37, 39
radiometric 415, 417, 432, 461
Ar-Ar 383
K-Ar 383, 404, 409, 415, 420
radiocarbon 409–509, 517
Rb-Sr 415
U-Th-Pb 409, 415
tree-ring 507
young ages 39
Davey, Kent i
David, Gary A. 251
Davidheiser, Bolton 63, 68
Davidson, Charles F. 75
Davies, Keith 105
Davies, Kevin 544
Davis, Ed (1905–1998) 46, 107
Davis, William Morris (1850–1934) 243, 256
Dawkins, Richard 58–59, 68, 76, 78, 553
Dawson, Charles 71
Dawson, George M. 297
day-age theory 537
de Bray, M. E. J. Gheury 454, 458
de Chardin, Pierre Teilhard (1881–1955) 71
De La Rocha, Christina L. 151
de la Tour, Cagniard (1777–1859) 127, 144
de Queiroz, Alan 107
de Viron, O. 193
Dean, Josh 430
Deane, R. P. 452
debate, written 109, 568, 570
deBeer, Gavin Rylands (1889–1945) 62–63, 464
Decarli, R. 452
decay 90, 419
bacterial 284
of DNA 100
organic 11, 122, 269, 276, 278, 282, 286–287, 294–295
radioactive 36, 39, 41–42, 378–379, 381–383, 385, 387–390, 392, 398, 402–409, 411–412, 414–415, 418–421, 424, 427, 430
Deccan Plateau 118, 135
Declaration of Independence 567
deep drilling 118
Deep Impact Mission 308, 318, 320–321, 326, 329–330, 348, 374
deep-sea drilling 187, 190
dehydroxylation 407, 430, 607
Deimos 347, 601
Dekker, Cees 79
DelHousaye, Darryl ii
Delitzsch, F. 461, 490, 492–493
Deloule, E. 372
Delsemme, A. H. 88, 327, 430
DeMarcus, Wendell C. 105
DEMETER spacecraft 188
Deming, Drake 450, 515
Demouchy, Sylvie 184
Den Hartog, J. P. 146
DeNevi, Don 296
Dennell, Robin 102
density discontinuities inside earth 183
Denton, Michael 52, 57–58, 62, 67, 76–77
DeSalle, Rob 100
Desch, Steven J. 385
Desert View 216
Desert Whales 137
deshe (Hebrew for plant kingdom) 479
design 7, 21, 25, 64, 76, 105, 527
Dessler, Alexander 85
deuterium 87, 310, 351, 372, 391, 400–401, 411, 416, 426, 599, 602

See also heavy hydrogen

Devine, Bob 82
 devolution 63
 Dewar, Douglas 81
 DeWolf, David 551
 DeYoung, Donald B. 602
Diadectes 67
 Diamond, Jared M. 517
 diamonds 119, 135, 142, 254
 diamonds in meteorites 345, 351
 Dicke, R. H. 94, 446
 Dickerson, Richard E. 81
 Dickey, J. O. 331, 580
 Dickey, Parke A. 102
 Dickens, J. M. 186, 190
 Dickinson, Mark 459
 Did it rain before the flood? 475
 Dietz, Robert Sinclair (1914–1995) 142, 147, 191, 341
 Diez, Anja 375
 Digby, Basset 293–296, 298–299
 digestion 11
 DiGregorio, Barry 143
 Dillehay, Tom D. 517
 Dillow, Joseph C. 294, 518, 524–525
 Dima, a baby mammoth 266, 273
 Dimroth, Erich 75
 dingo 50, 527
 dinosaur 13, 37–38, 50, 67, 70, 100–101, 123, 136, 143, 281, 464, 466–467, 493–495, 506, 518–519, 531, 539
 Behemoth 493, 495
 coelurosaurian 466
Compsognathus 464, 466–467
 DNA 38–39
 extinction 123, 494, 539
 fossilized footprints 13
 fossils 123
 growth rates 494
 Leviathan 494–495
 near poles 136
 ornithomimids 467
 plesiosaur 506
 soft tissue 39
 tyrannosaurids 467
 dinosaur eggs and goosebumps (on comet 67P) 338, 340, 365
 Diplomonads 63
 directed panspermia 75
 discontinuities 12, 52, 68
 disease 510
 dissolved metals 40
 Dixon, Dougal 467
 Dixon, Robert Vickers 144
 DNA 3, 15, 17–18, 56, 61, 81, 100, 533–534
 chimpanzee 17, 77, 534
 chloroplast 100
 decay 38, 100
 deterioration 510
 dinosaur 38–39
 formation of 81
 human 3, 56
 insect 100
 junk 18, 80
 length of 3
 mammoth 270, 288, 293
 mummies 38
 old 36, 38, 100
 plants 38, 100
 preservation 38
 production 20, 81
 protein formation 81
 DNA barcode 535
 Dobzhansky, Theodosius (1900–1975) 54–55
 Dodd, R. J. 321, 335
 Dodwell, George F. (1879–1963) 122, 136, 142, 605
 dog family (*Canidae*) 4, 6, 50, 527

Dohnanyi, J. S. 366
 Dolan, Thomas 420
 dolomite 264, 266, 596
 Dolphin, Lambert 458
 dolphins 23, 25
 Dombard, Andrew J. 377
 Donahue, Thomas M. 315, 334
 Donati, Giovanni Battista (1826–1873) 315
 Dones, Luke 87
 Donovan, Eric 255
 Doppler effect 32
 Doran, Peter T. 499
 Dörrfel, Georg Samuel (1643–1688) 315
 Dorit, Robert L. 536
 Dose, Klaus 76, 80
 Dott, Robert H. Jr. 67, 103
 double-blind test 432
 Douglass, John 222, 252
 dove 485
 Doyle, Arthur Conan (1859–1930) 71
 Doyle, Laurance R. 450, 514
 Dragert, Herb 183
 dragon legends 494–495
 Drake, Michael J. 86
 Drake, Nadia 106, 514
 Dressler, Alan 94
 drifting vs. shifting 153
Drosophila (fruit fly) 55
 Druyan, Ann 325–328
 dry ice 348
 Dubois, Eugene (1858–1940) 14, 71–72
 Dubrovo, N. A. 275, 292, 295, 298
 Duncan, Martin J. 327
 Dundas, Colin M. 333
 Dunlop, James 95, 463
 DuPuy, Dudley A. Jr. 294
 Durbin, B. 454
 dust
 airborne 282, 289
 excellent insulator 289
 interstellar 26–27, 29–30, 34, 36, 42–43, 105–106, 309
 meteoritic 41, 104
 moon 41, 104, 559, 562
 rounded by erosion 289
 storms 279–280, 289–290
 volcanic 280
 dust, Adam formed from 539
 Dutton, Clarence Edward (1841–1912) 216
 dwarf galaxies 445
 dwarfism 54
 Dynamic Explorer satellite 42
 Dzierwonski, Adam 193

E

$E=mc^2$ 459
 Earle, Paul S. 187
 Earth 457–458, 461–462, 470, 475, 485, 488–489, 492–494, 518–522, 524–526, 529, 532–533
 age of 37, 39, 41–43, 103–104, 530
 atmosphere 42, 75, 280
 axis 111, 122, 138, 148–149, 547
 divided (by water) in Peleg's day 515
 early 18, 22, 75, 80, 118
 Earth sciences 44, 48, 114
 evolution of 25
 evolution of life on 8, 12, 74
 features on 3, 111
 ice on 275
 magnetic field 26, 115, 147, 149, 178, 180, 192, 342, 547, 603, 605
 molten 28, 41
 moon, recession from 41, 576–580
 oceans 42
 orbiting satellites 42
 origin of life on 15, 79, 83
 planet 3, 26–27, 32–33, 40, 45, 48, 57, 64, 74, 80, 85–89, 94, 102–103, 105–106, 111, 116, 118–119, 123–125, 130, 133, 138, 140–141, 146, 280, 282–283, 529, 538
 spin rate 31, 41, 159, 576
 surface 14–15, 31, 38–39, 41, 48–49, 64, 74, 102, 111, 114, 118–120, 124, 129, 133–134, 142, 272, 277, 280, 290, 296
 temperature gradient 118
 Earth sciences 291, 336
 earthquake
 L'Aquila, Italy (2009) 565
 Sumatran (2004) 154
 earthquake mechanisms
 crack growth 185–186
 phase transformation 161
 plate tectonics 154
 earthquake precursors 154, 187–188
 earthquakes 50, 154, 162–164, 172, 180, 183, 186–187, 194, 254, 296, 391, 399, 411, 488, 547
 aftershocks 182
 Alaskan Good Friday (1964) 195
 along fracture zones 147
 along Mid-Oceanic Ridge 143
 cause of liquefaction 195, 207
 cause of tsunamis 210
 causes of earthquakes 185
 Charleston, South Carolina (1886) 166, 171, 182
 compression waves 154
 consequences of 154
 deep 161, 185
 due to water 154
 electrical activity 391, 401, 414, 418, 423, 428
 events surrounding 138, 185, 195
 far from plate boundaries 154
 first motion 154
 fracture zone occurrence 147
 Haiti (2010) 163
 intraplate 182
 Japan (2011) 163
 Kansu, China (1920) 277
 Lisbon, Portugal (1755) 182
 New Madrid, Missouri (1811, 1812) 166, 171, 182, 387
 Newfoundland (1929) 196
 Niigata, Japan (1964) 194
 plate tectonics 154
 precursors 185
 prediction 154
 San Francisco (1906) 155
 San Francisco (1989) 195
 shallow 161, 185–186
 tension failures 165, 172
 tension waves 154
 too wide to be caused by subduction 165, 172
 waves 121, 154
 East Kaibab Monocline 218, 254
 Easter Island 517
 Eber (great grandson of Noah) 515
 Eberhart, Jonathan 95, 105, 331
 Echo Cliffs 216, 222–224, 228, 240, 253
 Ecuador 136
 ed (Hebrew for *mist*) 475
 Eddington radiation limit 442
 Eden, Charles H. 293
 Eden, Garden of 478, 535
 Eden, Murray 54, 79
 Eden, rivers flowing out of 535
 Edey, Maitland 68, 99
 Edgett, Kenneth 373

Edwards v. Aguillard 550, 568
 Egyptian mythology 524
 Egyptian, 360-day year 185, 592
 Ehrenberg, Rachel 70, 499
 Ehrlich, Paul R. 63
 Einstein, Albert (1879–1955) 23, 85, 339, 380, 446, 457, 459
 Einstein's
 $E=mc^2$ 459
 second postulate 457
 theory of special relativity 457
 Eiseley, Loren C. 52
 Eisner, Thomas 84
 El Niño 140, 151, 155, 157, 169, 183, 298
 Elan Bank 187
 Eldredge, Niles 66, 98
 electrical
 charges 378, 391–392, 407, 419
 conductors 458
 electrical breakdown 378, 390–391, 425
 electron capture 382, 392, 400
 elements, chemical 462, 533, 538
 elephant in the living room 17
 elephants 13, 271–272
 Elhatisari, Serdar 429
 Eliot blackwelder
 proposal for the Grand Canyon 221
 Ellesmere Island 136, 138, 141
 Elliott, Bev 495
 Elliott, Tim 331
 elliptical halos 389, 401, 408, 424
 elliptical orbits 304–305, 307, 312, 327
 Ellis, Richard S. 450
 Ellsworth, William L. 182
 Elsässer, H. 366
 Eltringham, S. Keith 292, 299
 embryology 11, 62–63, 553
 embryos 11, 62–64
 Emerson, Ralph Waldo (1830–1911) 437
 Emery, G. T. 419
 Emery, J. P. 367
 Emery, Joshua P. 367
 emission spectrum 457
 Emmons, Samuel Franklin (1841–1911) 221, 237, 243
 Enceladus 346, 369–370, 595–596, 601
 Endress, Magnus 372
 energy
 binding 379, 382, 388, 400, 427
 in the subterranean water 447, 597
 kinetic 306, 380, 400, 407, 430, 520, 525
 potential 306
 Engel, M. H. 372
 Engels, Friedrich (1820–1895) 551
 England, Philip 190
 Eniwetok Atoll 157, 169, 184, 516
 Enoch 554–555
 Enoch (great grandfather of Noah) 505
 entropy 61, 90
 Enyart, Bob 526
 epicycles 33, 140–141
 Epstein, Samuel 298
 equinox 138
 erets (Hebrew for *earth*) 515
 erg, definition of 426
 Erickson, Gregory M. 495
 Erman, Adolph 295
 Ernst, W. G. 424
 Escalante Petrified Forest 232, 265
 escape velocity 303, 321, 326, 335, 343
Escherichia coli 23
 Esdras-2 495, 525
 eseb (Hebrew for *plant*) 479
 Eskimos (Inuits) 527
 Esposito, Larry W. 89
 ethane, in comets 307, 317, 321

- Etheredge, Jason** 84
Ethiopian language 516
eukaryotes 12, 66, 81
Euphrates, a pre flood river 475, 478, 535–536
Europa, moon of Jupiter 595–596
Europe 37, 120, 123, 142, 155, 263, 270, 274, 292, 298, 303, 497, 499, 517, 534
Evans, Rob L. 193
evaporation 121, 138, 140
Eve 529, 534, 554, 567
event horizon, of black holes 441, 444, 452
Everest (see Mount Everest)
Everhart, Edgar 327, 335
evidence (scientific), defined 438, 493
evolution 5
 as a faith 77
 biological 1, 3, 5–8, 10–15, 21, 23, 25, 37, 39, 52–60, 62–77, 79, 81–85, 98, 103, 296, 531–532, 553, 556–557
 chemical 14–15, 18
 definition of 549
 macroevolution 5, 9, 11, 25, 53, 61, 527, 539
 microevolution 5, 7, 53, 527
 of comets 328
 of complex biochemical systems 5, 55
 of heavier chemical elements 462
 of higher species 52, 62
 of human intelligence 56
 of language 60
 of life 14, 55
 of man 13, 84
 of organic complexity 5, 25, 51–52, 65, 69, 77, 296
 of planets 29, 87, 321, 335, 513
 of sexual reproduction 82
 of solar system 27, 29–30, 85, 89, 328
 of stars 34, 36, 43, 462
 of the eye 7, 25, 56–58
 of the mind 84–85
 of vertebrates 83
 social consequences of belief in 551
 theistic 57, 537–545, 557
 theory 21, 23, 53, 55, 62, 77, 82, 529
evolutionary
 ancestors 8, 11–12
 tree 8, 12, 23, 25, 65
Ewing, Maurice 210
excess fluid pressure 39, 102
Exodus, date of 482
expanding universe, big bang, inflation 32–33, 91, 439
expanse (raqia in Hebrew) 470, 518, 521–522, 526
Explanations for the Grand Canyon
 Charles B. Hunt 222
 Eliot blackwelder 221
 Grove Karl Gilbert 221
 Ivo Lucchitta 222
 John Wesley Powell 221
 Norman Meek and John Douglass 222
 Samuel Franklin Emmons 221
 Walt Brown 222
exploded-planet theory 337, 345
exponential decay 510
extinctions 8
 Mesozoic 143
 of coelacanth fish 37
 of dinosaurs 123, 143, 494
 of interplanetary dust 105
 of mammoths by man 279, 281, 288
 of marine bivalves 143
 reduced by genetic variations 527
extraterrestrial life 8, 513, 531
eye 7, 19, 25, 55–58, 269, 273, 279, 527
- failed-planet theory** 337, 345
faint-young-sun paradox 31, 90
Fairbanks Creek mammoth 269, 284
Falk, Dan 450, 514–515
Falkowski, P. 266
Faraday's Law 418
Farallon Plate 244, 256
Farb, Peter 70, 81
Farinella, Paolo 371
Farmer, Alison 451
Farrand, William R. 294
fast binary stars 34, 95
fast neutron 426
fast seismic waves under continents 165, 170
Faulds, James E. 250
faults in the Grand Canyon 216, 218–219, 221, 225–226, 237, 240, 243, 252
19-Mile 223, 251–252
Bright Angel 227, 252
Grand Wash 252
Havasu 251–252
Hurricane 252
Muav 252
Pausaugunt 252
Sevier 252
Toroweap 252
faults, geologic 111, 114, 154–155, 158, 166, 170, 178, 182–183, 185–186, 191, 222, 225–227, 236, 240, 242–245, 251–254, 256
feather imprints 465
feathered dinosaurs 464, 466
Fechtig, H. 366
Feduccia, Alan 67, 467
Feldman, W. C. 326, 481
Felix, Charles 141
Fellows, Larry D. 252
Fenton, Cassandra R. 256
Feral children 8
Ferguson, C. W. 509
Ferguson, Mark 101
Fermi, Enrico (1901–1954) 428, 533
Fernández, Julio A. 322–323, 332, 335
Ferroir, Tristan 368
Ferry, Georgina 512
Festou, M. C. 328
Field, Katherine G. 66, 77
Fields, Brian D. 431
Fields, Weston W. 531
fig trees and fig gall wasps 21
Filacchione, G. 330
Finch, Caleb E. 512
finches, Darwin's 136
Finkbeiner, Ann 514
Finkelstein, David 418
Finkelstein, S. L. 463
Finlay, Bland J. 52
fins-to-limbs jump 98
Fiorillo, Anthony R. 150
fireflies, bioluminescence in 25
Firestone, Richard B. 293
firmitment 522, 524
first cell 15, 76
first law of thermodynamics 32
Fischman, Joshua 100, 544
fish 12, 69, 278, 539
 bioluminescence in 25
 created on same day as birds 539
 DNA found in 200-million-year-old 38
 electrical capabilities 8
 frozen in underground river 278–279, 283
 in Cambrian 67
 living fossil (the coelacanth) 99
 navigation system 23
 no evolutionary ancestors 69
 saltwater and freshwater 502
 surviving the flood 502
fish to amphibian
 fossil gap 12, 99
 genetic gap 15
Fish, Steven A. 100
Fisher, D. A. 298
Fisher, Donald 98
Fisher, Robert L. 182, 191
fission 379–381, 386, 391–392, 404, 406, 408, 418–419, 421–422, 424, 426, 430
fit of the continents 48, 111, 133, 489, 516, 547
Fix, William R. 52, 62, 64, 74, 83
Flam, Faye 106
flank rifts 146, 148
flatness problem 94, 446
Fleck, John 326
Fleischer, David 106
flies 13, 71
Flint, Richard Foster 233, 296, 498
floating point operations (FLOPS) 57
flood 48, 478
 40 days and nights? 485
 biblical 3, 107, 295, 489, 518, 524, 530–531, 538, 554–555, 557
 canopy theory 518–526
 continental-drift phase 131
 date of 172, 185, 256, 284, 315, 318, 508–509, 527
 deposits 211
 disallowed as an explanation 291
 features caused by 48, 109, 130, 136, 260, 489, 506, 509, 518, 520, 524
 flood phase 129–131, 133, 138, 278
 forming fossils 12, 37
 global 195, 197, 200, 378–379, 389–393, 399, 402, 404–406, 408–409, 411–412, 414, 416–418, 599
 hail storm during early stage of 282–283
 legends 107
 liquefaction during 195, 197–198, 200, 202, 211
 local 107, 198, 207, 279, 287, 538
 log of flood year 485
 migration routes after 516
 postflood lifespans 518
 postflood racial characteristics 527
 pre flood seasons 519
 rain before 539
 recovery phase 136
 rupture phase 125, 521
 simplistic or poor explanations for 109, 291
 source of water 109, 518, 524
 subterranean water 489
 survivors 529
 worldwide 3, 48, 111, 123, 291–292, 507, 518, 520, 525, 538, 549
flood basalts 118, 134, 162, 165–166, 189
Flood Legends 49
flood phase 128, 130–131, 133, 138, 278
floodgates of the sky 492
flood-year chronology 485, 489
FLOPS (floating point operations) 57
Florida 495
Florindo, Fabio 192
flow surface boiling 394
flowering plants 13, 71
flutter 145, 197, 378–379, 390–391, 399–400, 402, 411
flying animals: birds, insects, reptiles (pterosaurs), mammals (bats) 10, 25
folded mountains 117
Folger, Tim 87, 90, 93, 193, 514
food chain 494, 506, 519
- footprints, fossilized** 38, 200, 211
Ford, E. B. 73
Ford, John 56
Forey, Peter 98
forming the core 160
Formisano, Vittorio 533
Forster, Piers 497
Forté, Alessandro M. 182
Fortey, Richard 56
fossilized
 cocoons 13
 footprints 38, 200, 211
 nests 13
fossils 99, 195, 464–467, 489, 518, 524, 530, 550
 animals in trenches 153, 165, 170
 ape-men 14, 71–73
 apes 68
Archaeopteryx 464
Cambrian explosion 68–70
 China 67, 69
 collections of 64
 compressed 11
 continental erosion 40
 dating 14, 37–38, 98, 415
 dinosaurs 101, 123, 494
 DNA 100
 earliest 15, 74
 evolutionist interpretation 207
 fish 67
 flying animals 13
 footprints 201
 formation of 122, 129, 138, 283–284, 298, 540
 gaps 12, 25, 64–66, 68, 296
 graveyards 48, 122
 index 37, 39, 97–98, 284
 insects 70
 intermediates 6, 64–67, 77, 467
 See also fossil transitional
 jellyfish 11
 man 14, 73–74
 marine 283–284
 missing trunk 12
 out-of-place 13, 70
 out-of-sequence 13, 70, 136
 plants 69
 polystrate 11
 Precambrian 203
 rapid burial 11–12, 201
 record 12, 64–68, 83, 122, 296
 sea life on mountains 122
 sequence 38
 sorted 138, 195, 198, 202–203
 superposition 199
 termites 100
 trace 201
 transitional 64–68, 464
 See also fossil intermediates
 tree trunks 116
 vertical sequence 13
 with frozen mammoths 284, 287, 293
 wood 271
Foulger, Gillian R. 189
foundations of the Earth 470–471, 476, 479, 489–490
fountains of the great deep 3, 50, 109, 125, 132, 138, 182, 278, 282, 301, 337–339, 342, 346–348, 351, 364, 391, 393, 395, 411, 414, 417, 472–473, 485, 488–489, 492, 518–521, 581, 585, 596–597, 601
Fournier, Robert O. 255
Fowler, William A. 414
Fox, Douglas 479, 499
Fox, Maggie 333
Fox, P. J. 141
fractals 92
fracture zones 113–115, 131–132, 146–

- 148
framework hypothesis 537, 543
Francis, Jane E. 141
Francis, Paul J. 452
Franck, E. U. 144, 601
Frank, Adam 96, 514–515
Frank, Louis A. 104, 315, 330
Franklin expedition 53
Fraser, Wesley C. 86, 375
Frazer, James George 107
Freber, Carl Roger 606
Freedman, David H. 84
Freedman, Stephen L. 95
Freeland, Stephen J. 61
Frenk, Carlos 97
frequency-modulated radar 23
freshwater fish 502
Freske, Stanley 430
Freund, Friedemann T. 418
Fricke, Hans 98–99
friction
 heat generation 133–134, 140, 155, 159, 161, 186
 in fluids 577
 in solids
 earthquakes 185
 inside earth 578
 prevents
 breaking continents 516
 forming mountains 117, 204
 overthrusts 118
 subduction 114, 165, 174, 593
 static 204
Friedlander, Gerald 474
Friedmann equation 447
Friedmann, Alexander (1888–1925) 447
Friedrich, Jürgen 141
Frings, Hubert and Marie 63
Frohlich, Cliff 185
frozen mammoths 48, 111, 118, 267–299, 547
 Bering barrier theory 279, 288–289
 crevasse theory 278, 285–286
 extinctions-by-man theory 288–290
 hydroplate theory 277, 281–284
 lake drowning theory 278, 284–285
 meteorite theory 280, 290–291
 mild ice age theory 279, 289–290
 mud burial theory 278, 286–287
 river transport theory 279, 287–288
 shifting crust theory 280, 290
 Why did it get so cold so quickly? 280
frozen rhinoceroses 118
fruit flies 7, 55
Fu, Wenqing 512
Fuentes, Cesar I. 375
Fujii, Naoyuki 430
Fujii, Noriko 80
Fuller, Myron L. 423
fully-developed organs 7, 57
fungi, bioluminescence in 25
furcula of Archaeopteryx 464–465
fusion (nuclear) 42, 122, 142, 378, 380, 391, 399, 405, 408, 421, 429
Futuyama, Douglas J. 553
- G**
- Gaïnd, Nisha** 329
Gaitskell, Richard 94
Galapagos Islands 7, 136
galaxies 32, 34, 36, 43, 91–92, 94–95, 97, 106, 440, 451, 454–455, 457–462
 clusters 32, 43, 92, 95, 106, 446, 451, 456, 460
 colliding 443
 distribution of 92
 dwarf 445
 elliptical 94
 formation of 97
 Milky Way 25, 36, 43, 106, 458, 533
 spiral 36, 43
 starburst 445
 strings of 444
 unstable 43, 106
Galileo Galilei (1564–1642) vi, 311, 567
Galileo spacecraft 336
Gallup, George Jr. 558
Gamkrelidze, Thomas V. 535
gamma rays 384
Gamow, George (1904–1968) 91, 398, 428–429
Gamwell, Thomas P. 104
Ganges Canyon 116
gap theory 529–531, 537
Garcia-Castellanos, D. 151
Garden of Eden 535
Garnett, Donald R. 453
Garrick-Bethell, Ian 481
Garstang, Walter 63
Gauthier-Lafaye, F. 422
Gavin, Anne-Claude 60
Gee, Henry 67, 71
Geiger, Beth 433
Geikie, Archibald 102
Geisler, Norm 545
Geissler, Rex 106
Geller, Margaret J. 92, 97, 451, 461
Gelling, Cristy 192
gene 527, 529
genealogy chart of patriarchs 504
genes 6–8, 11, 54, 57, 59, 62, 81, 83, 544
Genesis
 in Chinese 48
 New Testament support of 548–555
genetic bottleneck 510
genetic code 9, 60, 62, 81
genetics 6, 19, 51–55, 60, 66, 78
 Adam 534–535, 567
 characteristics 527, 529
 diseases 518
 distances 15, 77–78
 information 17, 22, 78–79
 material 7, 9, 15, 18
 Mitochondrial Eve 534–536
 potential 527
 variability 527
Gentet, Robert E. 74, 102
Gentry, Robert V. 97, 102, 248, 257, 388–389, 421, 423–424, 430
geocentric theory 141
geologic
 column 38, 98–99, 103–104
 record 64–65
geomagnetic jerks 180
George, T. Neville 68
geothermal
 gradient 142
 heat 48, 111, 118–119, 138, 547
Geraci, Giuseppe 372
Germanic languages 534
Germany 99, 135, 465
Germany's Deep Drilling Program 385
Gesenius, Wilhelm 493
geshem (Hebrew for violent rain) 485, 488–489, 492, 519–520, 525
Ghez, Andrea M. 96, 452
Ghosh, A. K. 69, 71
gibbon 14
Gibbons, Ann 67, 467, 536
Gibbs, Philip 366
Gibbs, W. Wayt 80
Gibcus, Johan H. 79
Gibney, Elizabeth 93, 145, 365, 453
Gibraltar 140, 151
Giem, Paul 420, 509
Gihon, a pre-flood river 478
Gilbert, Grove Karl (1843–1918) 237
proposal for the Grand Canyon 221
gill slits, interpreted by Haeckel 11
Gillespie, C. M. Jr. 105
Gilmore, Gerard 93
Giotto spacecraft 303, 325
giraffes, origin of long necks 5
Gish, Duane T. (1921–2013) 71, 75, 83, 297
Gitt, Werner 61
glaciers
 Antarctic 282
 compared to rock ice 275
 formation of 116, 140
 frozen mammoths 286
 frozen mammoths in 286
 global warming 496–497
 Ice Age 48, 111, 547
 in Siberia 286
Gladwin, Harold S. 509
Glaessner, Martin F. 64, 70
Glanz, James 91–92, 463
Glavin, Daniel P. 372
Glen Canyon Dam 215
Glikman, Eilat 450
global “X-rays” 165, 170
global flood, date of 482
Global Positioning System (GPS) 161, 171–172, 595
global warming 495–497
globular clusters 36, 96, 462
Glock, W. S. 509
Gloeckler, G. 326
glycine 301, 307, 311, 317, 321
Goesmann, Fred 330
gold 28, 87, 184, 600, 605
Gold, Thomas (1920–2004) 104
Goldberger, Robert F. 76
Goldblatt, Dan 256
Golden Gate Bridge 140
Goldschmidt, Richard B. (1878–1958) 55, 66
Goldsmith, Donald 185
Golenberg, Edward M. 100
good vs. evil 551
Goosenecks (meandering river) 232, 250
Gordon, Richard G. 190
gorillas 68, 72, 536
Gorman, James 101
gosling 527
Gosnell, Mariana 499
Goulay, Marcel 83
Gould, A. 515
Gould, Meredith 82
Gould, Stephen Jay (1941–2002) 53, 56, 58, 64–66, 68–69, 529, 552
GPS (Global Positioning System) 161, 171–172, 595
GRACE satellite system 154
Gradie, Jonathan 372
gradualism 299
Graham, David 432
grammar 8, 60
Grand Banks, turbidity currents 196
Grand Canyon 3, 12–13, 38, 69–71, 110–111, 114, 116, 124, 133, 138, 202–203, 264, 547
 compared to ocean trenches 114, 153
 compared to submarine canyons 116
 cross-section 202
 inner gorge 133, 135, 218–219, 227, 237, 240, 242–245
 origin of 48, 138–257
Grand Canyon Caverns 218, 240, 251
Grand Canyon Village 257
Grand Lake 140, 214–215, 222–234, 236, 238, 240, 248–249, 253, 256–257
 elevation 140
 location 140, 222–226, 228–232, 234, 236, 238, 240
 map 222–226, 228–232, 234, 236, 238, 240
 petrified forests in 265
Grand Staircase 223, 225–226, 236, 253
Grand Wash Cliffs 244
Grand Wash Fault 252
granite
 continents 28, 119
 crushed 118, 131, 135
 hydroplates 131, 133
 never molten 28
 photo of 119
 under ocean floor 162, 168
Grant, Andrew 93, 142, 514–515
Grassé, Pierre-Paul 55–56
gravitational accretion 31, 183, 603
gravitational attraction
 forming galaxies 36, 92, 97, 451, 460
 forming planets 29
 inside a hollow sphere 303
 of binary stars 34
 of planets 42
gravitational force 520–521
gravitational settling inside earth 155, 159, 183, 603
gravity
 anomalies
 beneath mountains 134
 beneath trenches 154, 164, 180
 Colorado Plateau, balanced 119
 deformation of rock ice 275
 effect on
 asteroids 338, 341
 comets 302–306
 earthquakes 154, 182
 hydroplates 114
 subduction 593
 of black holes 34
 of Venus 31
 singularity 34
 gravity waves 442
Gray, Ginny 77
Gray, R. D. 517
Grayloise, Presse 64
Greally, John M. 80
Great Denudation 216, 236
great denudation 216
Great Salt Lake 121, 138
Great Unconformity 100, 202, 218, 220, 237, 241–246
Great Walls, in outer space 92, 97, 452, 460
great-circle path 114, 125, 143
Greek
 360-day year 185
 language 516
 mythology 524
Greek words
 genos (family) 529
 hudor (liquid water) 521
 katakluzo (flooded) 470
 kosmos (world, order) 533
 stereoma (firm) 522
Green River Formation 201
Green, David E. 76
Greenberg, E. Peter 84
Greenberg, Richard 335
Greene, George 46
Greene, Jenny E. 450
Greenfield, Mark B. 417
Greenfieldboyce, Nell 89
greenhouse effect 30, 520, 563, 609
Greenland 495
Greenwood, J. P. 331
Gregorian calendar 484

Gregory, Stephen A. 92
Greve, S. 182
Grey Cliffs 225
Grieve, Richard A. F. 335
Grimaldi, David 70
Groot, Hans de Groot 498
Gross, Richard S. 187
Grossman, Lisa 374
Grott, Matthias 431
Gubbins, David 141, 193
Gulbis, Amanda A. S. 376
Gulf of California (Sea of Cortez) 110, 215, 222, 233, 241–242, 256
Gulf of Mexico 121, 396–397
Gunn, James E. 452
Gunnison River 135
Gura, Trisha 77
Guste, William J. Jr. 58
Guth, Alan H. 449–450
Guthrie, R. Dale 269, 272, 292–294, 299
Guyana 13
guyots 169

H

Haar, Lester 210, 487
Häberlein, Ernst 464
Häberlein, Karl 464
Hadju Ahmed map 497
Haeckel, Ernst Heinrich (1834–1919) 11, 63–64, 553
Hagadorn, James W. 64, 212
Hagberg, Stephen C. 502
Hagen-Poiseuille flow 212
Hagopian, George 46, 49, 106
Hahn, H. P. 419
Hainaut, O. R. 335
Halbrook, David 107
Haldane, J. B. S. (1892–1964) 84
half-life 382–383, 388–389, 403, 407–408, 417–418, 421, 506–507
Hall, Donald N. B. 89
Hall, Shannon 188, 192
Hall, Stephen S. 566
Halley, Edmond (1656–1742) 41, 315, 334
Halliday, Alex N. 368
Ham (son of Noah) 529
Ham, Ken 564
Hamann, F. 463
Hamilton, Warren B. 189, 191
Hammer, William R. 150
Hammond, Allen L. 71, 428
Han, Shin-Chan 182
Hance, John (early Grand Canyon resident) (1840–1919) 215
Hand, Eric 96, 325, 329, 365, 377
handedness, left and right 18, 80
Hannay, J. B. 145
Hanor, Jeffrey S. 266, 426
Hapgood, Charles H. (1904–1982) 273, 294, 296, 298–299, 497, 499
Harbaugh, John W. 431
Harder, Ben 86
Hardy, A. C. 73
Harington, C. Richard 150
Harlan, Tom 509
Harms, A. A. 386, 404, 422
Harrison, Edward Robert 91, 546
Hartley 2 308, 348
Hartley, Karen 452
Hartmann, William K. 88
Harwit, Martin 95–96, 335, 431, 440
Haseltine, Eric 142
Hasiotis, Stephen T. 71
Hasofer, Michael 458
Hattori, M. 95

Hatzes, Artie P. 515
Hau, Lene Vestergaard 459
Haukioja, Erkki 51
Hauri, Erik 89
Hauser, Marc D. 60
Havasut Fault 252
Havasupai legend for Grand Canyon 256
Hawaiian Islands 167, 189, 517
Hawking, Stephen W. 90
Hayabusa spacecraft 348
hayah (Hebrew for was) 530
Hayden, Erika Check 81
Haymes, Robert C. 88
Head, James N. 374
headward erosion 216, 222, 233, 244, 256
heat conduction 118, 280
heat during the flood 87, 125–126, 180, 280, 394–395, 421, 423, 426–427, 430, 563, 581, 595, 597, 602–603
heavens stretched out 439, 449
heavy elements (production of) 25, 34, 93, 95, 109, 321, 462, 538
heavy hydrogen 28, 34, 87, 95, 310–313, 315, 317, 321, 330, 351, 405, 411
Hebrew
360-day year 185
language 485, 516, 523, 529
Hebrew words
ammud (pillars) 471
arubbah (floodgates) 492
asah (made) 543
badal (separate) 522
baqa (burst open) 492, 519, 523
baqia (breaches) 523
chuppah (canopy) 522
deshe (plant kingdom) 479
ed (mist) 475
erets (earth, land) 515
eseb (plant) 479
geshem (violent rain) 485, 488–489, 492, 519–520, 525
hayah (was) 530
kaal (all) 544
kopher (pitch, ransom) 555
matar (normal rain) 519
mayim (liquid water) 476, 521
mikveh (gathering) 555
natah (stretched) 439
peleg (divide by water) 516
raah (appear) 543
raqa (spread out) 522–523
raqia (expanse) 471, 521–522, 526
shamayim (heaven) 471, 522
shaphrur (canopy) 522
siach (shrub) 479
sukkah (canopy) 522
tavek (within) 522
tebah (Ark, box, chest) 107
tehom (surging subterranean water) 492
yom (a literal day) 538
Hecht, Jeff 184, 453
Hecht, Max K. 98
Hedman, M. M. 369
Heezen, Bruce C. 210
Heide, Fritz 103
Heidelberg man 14
Heirtzler, J. R. 190
Heisler, Julia 328
Heitzig, Skip ii
helium 29, 32, 34, 39, 88, 92–93, 102, 105, 321, 379–380, 385, 399–401, 405–406, 421, 428–429, 462, 538
helium-2 nebulae 446
Helleman, Alexander 94
Helmick, Larry S. 97
Helou, George 453

hemoglobin 54
hemophilia 54
Henderson, G. H. 388, 407, 423–424
Henry's Law 266
Henze, Katrin 66
Herd, Christopher D.K. 374–375
Hereford, Richard 251
Hermes 368
Herschel, William (1732–1822) 96
Hertzprung-Russell diagram 34
Herz, Otto F. 273–275, 283, 285–286, 294–296, 299
Hess, Harry Hammond (1906–1969) 169, 190
Hester, J. Jeff 431
heteroplasmy 535
Hevelius, Johannes 332
Hickerson, William J. 150
hidden assumptions 36, 454, 556
Hidden Canyon 256
Hill, Harold 56
Hill, William Charles Osman 68
Hills, Jack G. 332
Himalayan Mountains 413
Himmelfarb, Gertrude 58
Hinchliffe, Richard 67–68
Hindu, 360-day year 185
Hinton, Martin A. C. 71
Hirabayashi, Masatoshi 371
His, Wilhelm 64
Hishita, S. 422
histones 20
Hitching, Francis 52, 55, 63, 65, 72, 74, 81
Hitler, Adolf (1889–1945) 527, 552
Hobble Canyon 256
Hodge, Paul W. 97
Hogan, Jenny 94, 453
Hogarth, James 145
Holden, Constance 98, 536
Holm, Richard W. 63
Holman, Matthew J. 375
Holme, R. 193
Holmes, Francis S. 70
Holroyd, Edmond W. 236, 248, 256
Homo erectus 14
Homo ergaster 71
Homo habilis 14, 71–72
homologous structures 62
honeybee 13, 21
Honthaas, Christian 187
hoofprints, fossilized 13, 495
Hooke, Robert (1635–1703) 315, 334, 567
Hooker, Dolph Earl 297
Hoover, Richard B. 372
Hopi Lake 222, 224, 226–228, 230–236, 238–240, 245, 248, 255–256
elevation of 140
location of 140, 222, 228
petrified forests in 265
Hopi migration to Americas 169, 517
Hopkins, Michelle 421
Hoppe, Kathryn 100
horizon problem 443, 447, 455
horizon, between layered strata 199
Hornaday, William T. 294
Hornbacher, Dwight 213
Horner, Jack R. 101
Horner, Jonathan 357, 376
horse, claimed evolution of 13, 65
hot Jupiters 441, 448, 450, 515
hot moon 42, 104
hot planets 42, 105
hotspot hypothesis
genetics 536
geology 167, 189–190
Housley, R. M. 431
Housner, George 210

Hovland, Martin 143–144, 428
How to Evaluate Theories 122
Howard, Alan D. 252
Howe, George F. 62, 71
Howarth, Henry H. 292–296, 299
Hoyle, Fred (1915–2001) 57, 68, 79, 82–83, 86, 95, 106, 298–299, 326, 329–330, 333, 372, 414, 431, 464, 466–467
Hsieh, Henry H. 367, 370
Hsu, Hsiang-Wen 369
Hsu, Kenneth J. 142
Hualapai legend for Grand Canyon 256
Hualapai Limestone 215, 219, 222, 238, 244–245, 250, 257
Hubbert, M. King 212
Hubble Deep Field North 456
Hubble Space Telescope 88, 95, 323, 349, 371, 432, 456, 461, 513
Hubble, Edwin Powell (1889–1953) 32, 400
Hubble's law 95, 439, 447, 449, 453
Huber, Julie A. 141
Huc, M. 297
Huchra, John P. 92, 97
Hudson Canyon 116
Huggins, William (1824–1910) 315, 325
Hughes, David W. 89, 585
Hughes, Jennifer F. 78
Hughes, Malcolm 509
Hughes, T. McKenny 146
Huguet, Ludovic 185
Huh, Chih-An 419
Hull, D. E. 75
human
artifacts in deep rock 39, 74, 102
brain 56–57, 60, 84–85
jaw 14, 72
longevity 504–505, 516, 518
racess 527–529
skeleton 508
tools 13
humanlike footprints, fossilized 13, 38, 99, 493
Utah, Kentucky, Missouri, Pennsylvania, Laetoli 38
Humble, Ronald W. 582
hummingbird 23, 466
Humphreys, D. Russell 102, 248, 421, 526, 563–564, 602
Hunt, C. Warren 424
Hunt, Charles B. (1906–1997) 222, 237, 245, 252, 256–257
Hunt, Will 188
Huntoon, Peter W. 254
Hurlbut, Terry 484
Hurricane Fault 252
Hurst, Laurence D. 61
Hurtley, Stella 374, 432
Hutcheon, Ian D. 372
Hutchinson, Axex 453
Hutton, James (1726–1797) 52
Huxley, Julian (1887–1975) 54, 73
Huxley, Thomas Henry (1825–1895) 464
Huyghe, Patrick 104, 330
Hwang, Chainway 141
hydraulic lift 226
hydrogen 15, 29, 32, 48, 74, 93, 105–106, 111, 298, 462, 538
hydrogen and helium 29, 32, 34, 88, 92–93, 105, 321, 330, 538
hydroplate 111, 113–115, 118, 122, 132, 134, 136, 140–141, 147, 222, 391, 399, 411, 418, 479, 488–490, 492, 519, 522
acceleration of 131–132
compression of 131, 133

crushing and thickening of 131, 133, 136, 139, 148–149, 170, 297, 473, 488, 492
frictional heating at base of 134, 140
maximum speed of 487
hydroplate theory 109–151, 561
 497
assumption 124
consistent with Bible 488–493
events of 125
explanation for
 asteroids, meteoroids 128, 337–374
 coal, oil 130
 comets 122, 300
 Earth's magnetic field 180
 Earth's radioactivity 360, 364, 379, 390, 400–401, 407, 414, 416–417
 fossils 128
 fracture zones 147
 frozen mammoths 128, 267–299
 geothermal heat 134, 603
 global warming 495–496
 Grand Canyon 138, 215–257
 Ice Age 140
 inner and outer core 155, 603
 jigsaw fit of continents 48, 111, 133, 489, 516, 547
 limestone 130, 259–266
 magnetic anomalies 131
 metamorphic rock 135
 methane hydrates 136
 Mid-Oceanic Ridge 130
 ocean trenches 135, 152–192
 plateaus 136
 seamounts, tablemounts 134
 strata, layered fossils 128, 194–213
 submarine canyons 136
phases
 continental-drift 130
 flood 128
 recovery 136
 rupture 125
 spring analogy 132
hydrosphere 472, 475
hydrostatic compression 608
Hylonomus (early reptile) 67
 Hyman, Libbie Henrietta 63
 Hyndman, Donald W. 213
 Hyndman, R. D. 474
 Hynek, J. A. 104, 335
hyperbolic orbits 305, 307, 312, 328
Hyperion (a moon of Saturn) 377
hypothesis 30, 59, 76–77, 98, 120, 178, 373, 458, 536, 549

I

IAU (International Astronomical Union) 28

Ibba, Michael 60
ice 518, 520–522, 525
 on Moon, Mercury 310
 rock ice 274–276, 279, 281–284, 286–291, 298
Ice Age 48, 111, 116, 124, 138, 140, 488, 496, 517, 531, 547
Bering barrier theory 279, 288
comet impact theory 525
faint-young-sun paradox 31
gap theory 531
hydroplate theory 116, 140, 282–283
 mammoths 271, 276, 279–281, 283, 288–291, 293, 297
meteorite theory 280, 291
shifting crust theory 280
ichthyosaur 25
Ides, E. Ysbrants (1660–1705) 269, 292, 297
Idso, Sherwood B. 497
Il Enoch 525

Ilijas, Anna 453
immune system 22, 82–83
Imperial Sand Dunes 233
Incas, 360-day year 185
incest 544
inclined orbits 27
index fossils 37, 39, 97
India 107, 118, 139, 529
Indian Ocean 37, 114, 149, 159, 162, 168, 182, 187
Indo-European languages 534–535
Indonesia 517
Indus Canyon 116
Inflation, during big bang 450
information 9, 17–18, 22, 59, 61–63, 65, 67, 77, 79, 81
Ingersoll, Andrew P. 105
Ingersoll, Leonard R. 104, 422
inheritance, human characteristics 529
inner core of Earth 155, 184
inner gorge of the Grand Canyon 133, 135, 218–219, 227, 237, 240, 242–245
insects 7, 12–13, 19, 23, 38, 55, 70, 81, 272, 538–539, 544
 flight 10, 25
 metamorphosis 25
Institute for Creation Research (ICR) 297, 458, 520, 525, 554, 558, 560, 562, 564
intelligence, thoughts, brain 9, 15, 23, 56, 61, 76, 79, 85
Intelligent Design 558
interconnected chambers 111, 124
interconnected continents 124
interconnected subterranean chambers 48, 312, 489
intergalactic medium 441
intermarriage 544
intermediate-period comets 306
International Astronomical Union (IAU) 28
interstellar
 bacteria 309
 cellulose 309
 dust 26–27, 30, 34, 42, 105–106, 309
 gas 34, 95
 intestine 11
Inuit 527
invertebrates 12, 63, 65–67
Io 321, 596
ionization of water 144
ionosphere 163
Iorio, Lorenzo 334, 375
Ipe, N. E. 425
iridium 123, 143
Irion, Robert 93, 96–97, 451, 453, 514
iron in most distant stars 462
iron meteorites 40, 320, 341, 366, 368, 474
irregular moons 369, 597, 601
Irving, Jessica C. E. 185
Is Africa splitting into two continents? 179
Is Pluto a Planet? 28
Isbell, Douglas 329
isms, negative connotations 556
ISON (International Scientific Observation Network) 319
isostatic balance 119
isostatic equilibrium 154
isotopes 233, 345, 351, 367–368, 380–383, 386, 388–390, 392–393, 400, 402, 406–409, 412, 414–415, 417–421, 423, 426–428, 430, 506, 508, 510–511
 hydrogen 310
 oxygen 353
Itoh, Shoichi 431

Itokawa 348, 373
Ivanhoe, Francis 73
Ivanov, V. V. 535
Ivo Lucchitta
 proposal for the Grand Canyon 222
Izu Trench 152

J

Jablonski, David 143
Jack Point 253
jackal 50, 527
Jackson, Julia A. 211, 252, 298
Jackson, Matthew G. 433
Jackson, Stephen P. 82
Jacob 483
Jacobsen, Steven D. 184
Jaeger, J. C. 421
Jahren, A. Hope 150
James, Jamie 495
Janeway, Charles A. Jr. 82
Japan 161, 494
Japan Trench 152, 161
Japheth (son of Noah) 516, 529
Jasher, The Book of 490, 501
Jastrow, Robert (1925–2008) 56, 449–450, 454
Java man 14, 71–72
Java Trench 152
Jayawardhana, Ray 104
Jeans, James H. (1877–1946) 84, 90, 513
Jefferson, Thomas (1743–1826) 107, 301
Jeffreys, Harold (1891–1989) 85
jellyfish 11–12
Jenkins, Gregory S. 89–90
Jenkins, Jere H. 419
Jensen, Karen 211
Jerlström, Pierre G. 495
Jerome, Arizona, mining in 600
Jerusalem 466
Jewitt, David C. 349, 370–371, 375–376
Jhelum River, Kashmir 139
jigging (a simple form of liquefaction) 201
jigsaw fit of continents 48, 111, 121, 133, 489, 516, 547
Jochmans, J. R. 102
Johannsen, W. L. 52
Johanson, Donald C. 68, 72, 99
John Wesley Powell
 proposal for the Grand Canyon 221
Johnson, Phillip E. 85, 562
Johnstown Flood 221
Jonas, J. 601
Jones, G. A. 419, 508
Jones, Nicola 498
Jordan, David Starr 64
Joseph (Egypt's second in command) 505
Josephus, Flavius (A.D. 37–100) 45, 334, 483
Juan de Fuca Plate 256
Judson, Sheldon 187
Julian calendar 484
Jull, A. J. T. 372
Jungers, William L. 73
junk DNA 18, 80
Jupiter 26–27, 29, 88, 105, 304, 327, 336–337, 365
 heat from 42
 moons of 346
 rings of 30, 88
Jupiter's family 304–305, 310–312, 315, 317, 327
Jupiter's Io, volcanoes on 321

K

kaal (Hebrew for all) 544
Kahle, Charles F. 147
Kaibab
 limestone 216, 220, 223, 225, 227–228, 236, 240, 242, 245, 251
 Plateau 215–217, 220–222, 226, 228, 237, 240, 242–245, 248, 253
 squirrel 255
Kaiser, David I. 450
Kane, Gordon 91, 93
Kang, C. H. 107
Kanipe, Jeff 452, 463
Kant, Immanuel 513
Kaplan, A. E. 426, 430
Kaplan, Martin M. 54, 79
Kargel, Jeffrey S. 370
Kasahara, Junzo 183
Kashmir 139
Kasting, James F. 90
katakluzo (Greek for flooded) 470
Kaufmann, William J. 429
Kaufmann, William, III 106
Kay, Marshall 70
Kazakhstan 142
Kedung-Brubus, Indonesia 72
Keil, C. F. 461, 490, 492–493
Keinan, Alon 512
Keith, Arthur 73
Kekulé, Friedrich August (1829–1896) 438
Keller, Gerta 143
Kelley, Jack 515
Kelley, S. P. 184
Kelso, A. J. 68
Kemler, Emory N. 606
Kemp, Thomas S. 67, 98
Kenneally, Christine 59
Kennedy, D. James i
Kennedy, George C. 103, 119, 142, 226
Kennedy, Kenneth A. R. 72
Kennicutt, Robert C. Jr. 95, 462
Kenyon, Dean H. 58, 76, 80
Kenyon, Scott J. 376
Kepler, Johann (1571–1630) 567
Kepler's third law 578
Kepler-11 514
Kermadec Trench 152
kerogen 122, 325, 352
Kerr, Richard A. 59, 85, 87–88, 90, 105, 142, 182, 191, 326, 368–369, 372–374, 419, 430, 596
Kerrich, Robert 87, 602
Kerridge, John F. 87, 335
Keuck, Gerhard 64
Khain, V. Ye 191
Kieckhefer, R. M. 187
killifish 151
Kimberley, Michael M. 75
kin selection theory 59
kinetic energy 306, 353, 520, 525
King James translation of the Bible
 470, 522–523, 529, 531
King, A. R. 95
King, Elbert A. 430
King, Ivan R. 462
Kingman, Arizona 222
Kirk-Davidoff, Daniel B. 141
Kirkwood, Thomas 511–512
Kirschvink, Joseph L. 374
Kitcher, Philip 82
Kitts, David B. 66, 98
Kivelson, Margaret Galland 369
Kleeman, Elise 295
Klein, Michael 471
Klemperer, Simon L. 148
Klotz, John W. 54

Knudsen, Per 596
Kodachrome Basin, Utah 206, 213
Koerner, R. M. 298
Koestler, Arthur 54
Kofahl, Robert E. 84
Kola Peninsula, Russia 118
Konacki, Maciej 515
kopher (Hebrew for pitch, ransom) 555
Koppel, Tom 84
Koppers, Anthony A. P. 189
Koran 567
Kormendy, John 452
Koronovsky, N. V. 428
Koschinsky, Andrea 143
kosmos (Greek for world, order) 533
Kozlovsky, Yevgeny A. 142
Krakatau (a powerful 1883 volcanic eruption) 146
Krasnopolsky, Vladimir A. 329
Kratter, Kaitlin M. 450
Krause, Hans 293, 299
Kreutz Sungrazers 319
Krieger, Kim 417
Kring, D. A. 86, 328
Krot, Alexander N. 371
Kruglinski, Susan 184
Kruzhilin, Y. 70, 495
krypton 353
Kuban, Glen J. 495
Kubiak, Henryk 299
Kuhn, Thomas Samuel (1922–1996) 141, 325, 335
Kuhn, William R. 90
Kuiper Belt 315, 323, 356, 358, 364
Kuiper, Gerard P. (1905–1973) 323, 335
Kulesha, Preston 306
Kuppers, Michael 365, 372
Kuril Trench 152
Kwok, Sun 89

L

Labbé, Ivo 458
Labini, Francesco Sylos 92
Lachenbruch, Arthur H. 429
Lada, Charles J. 96
Ladd, Harry S. 184
Lagerkvist, C. I. 328
Lagrange points 349–350
Lagrange, Joseph Louis (1736–1813) 315, 332
LaHaye, Tim 106
Lain, Edward C. 74, 102
Laitman, Jeffrey T. 60
Lake Bonneville 138, 236
Lake Cahuilla 233
Lake California 140
Lake Kashmir 139
Lake Michigan 214, 221, 225, 235, 498, 547
Lake Missoula 221, 236
Lake Titicaca 151
Lake Vida 498
Lake Vostok 498–499, 547
Lamarckism 5, 51
Lamb, Harold 293
Lammerts, Walter E. 70, 99
Lamy, P. 89
Lancaster-Brown, Peter 333
land bridge 136, 279, 295
Landes, Kenneth K. 183, 186
Landsman, Zoe 367
Landy, Stephen D. 91
language 8–9, 59–60, 534, 540
 geographic origin of 534
 multiplication of at Babel 515
 origin of 540

specific languages

Austronesian languages 517
Chinese, ancient 48
Coptic 516
Ethiopian 516
Germanic languages 534
Greek 9, 516
Hebrew 485, 516, 523, 529
Indo-European languages 534
Latin 9
Romance languages 534
Vedic Sanskrit 9
Laplace, Pierre-Simon Marquis de (1749–1827) 315, 327, 513
Larsen, John 146
Larson, Daniel R. 79
larva (metamorphosis) 19–20, 81
late heavy bombardment of Moon 592
Lattimer, James 142
Lauretta, Dante 330
lava 48, 74, 103, 111, 118, 134–135, 547
lava lamp 144
law of biogenesis 5, 51
Lawrence, Jesse F. 184
Lawson, Stefanie L. 432
lead in extremely distant stars 462
lead, helium diffusion 39, 102
Leakey, Louis (2903–1972) 14
Leakey, Mary 14
Leakey, Richard E. F. 73
Ledercq, S. 69
Leduc, Guy G. 141
Lee, Alfred (searching for Ark) 46
Lee, H. D. P. 333
Lees Ferry 251
Leet, L. Don 187
legends 49, 107, 124, 151, 169, 256, 494
Lemonick, Michael D. 91, 376, 452
lensing, during liquefaction 198–201, 211
Lerner, Eric J. 91, 94
Leslie, Mitch 81
Lester, Lane P. 52
Leviathan 494–495
Levin, Harold L. 210
Levinton, Jeffrey S. 68
Levi-Setti, Riccardo 56
Levison, Harold F. 327, 377
Ley, Eugene H. 365, 431
Lev-Yadun, Simcha 536
Lewin, Roger 53, 56, 69, 71, 73, 141, 529
Lewis, C. S. (1898–1963) 23, 84–85
Lewis, John S. 368
Lewis, Richard S. 141
Lewontin, Richard 16
Ley, Willy 292–293
Li Chung-feng 315
Libby, Willard Frank (1908–1980) 507–509
Liebovitch, Larry 61
life in outer space 531–532
lifespans of patriarchs 504–505, 516, 518
lifespans, decline after the flood 505, 518
light speed 449–450, 454–459, 462
 $E=mc^2$ 459
light-gathering instruments 462
light-mill (see radiometer effect)
Lilley, J. S. 418
Limaye, Sanjay 145
limestone 48, 111, 119, 126–127, 259–266, 403, 478, 547
as cementing agent 119, 260, 262, 264
carbon in 74
caverns, caves 37, 97, 262–263
chemical reactions involving 260
formation of 119, 130, 138, 260–261

fossil footprints in

Hualapai 215, 219, 222, 238, 244–245, 250, 257
in meteorites 351
in the Grand Canyon 238
on Mars 352, 372
other forms of 266
present formation of 260
purity, implications of 119
quantity on Earth 119
quarry, demonstrates upbuckling 130
Solnhofen 465
the dolomite problem 264
with mammoths 283–284
Lincoln, Abraham 446
Lindahl, Tomas 82, 100
Linde, Andrei 439, 450
Lindgren, Johan 101
lineaments 399, 401, 411–412, 428, 431
linguist 9, 25, 60
Linton, Ralph 60
liquefaction 128, 138, 194–213, 222, 261, 283, 465
aquifers 129, 200
Ayers Rock 207
breaking transatlantic cables 196
causing quicksand 195
computer simulation of 211
consequences of 195
cycle during flood 197, 199
definition of 196
demonstration of 198
during
 compression event 202, 414
 earthquakes 194–196, 207
 global flood 197–198, 200, 202
 local floods 198
 wave-loading 196
examples of 195–196
explaining varves 201
failed pipelines 194, 196, 210
global 195, 199–200, 205
lens 198–201, 211
massive 195, 203, 207
mechanics of 196
mounds 195, 206–208
observations during 198
on a small scale 195
overturns principles of geology 200
plumes 195, 206–207
produced by jiggling 201
separating sediment layers 198
sorting
 coal layers 202
 limestone 202
 organisms 201–202
 sediment layers 199–200
strata and sorted fossils 195
vs. uniformitarianism 200
water vents 208
Lisle, Jason 545
Lissauer, Jack J. 87, 89, 365, 515
Lisse, Carey M. 330, 377
Lister, Adrian 293–294
lithium 379, 383, 399–401, 412, 416, 420
Little Colorado River 140, 216–217, 228, 248
Liu, Lin-gun 419
living technology 23, 83
lizard 6
lobe-fin fish 98
Lockyer, J. Norman (1836–1920) 185, 592
Loeb, Abraham 451–452
loess 275–277, 281–282, 284, 286–291, 296
Loewe, Laurence 536
logical fallacies involving evolution 11, 296, 325, 329, 353, 372–373

Lomax, Becky

213
Lomonosov Ridge 150
Long, Austin 432, 509
longevity, human 504–505, 516, 518
Longinelle, A. 426
Longo, Michael J. 451
long-period comets 305, 328
Looney, Leslie W. 431
Lord Rayleigh (John William Strutt) (1842–1919) 421
Lorenz, Ralph D. 362
Lorenzi, Rossella 372
Losos, Jonathan B. 78
Loucks, Robert R. 87, 602
Love, S. G. 431, 585
Løvtrup, Soren 53
Lowe, Christopher J. 212
Lowell, Percival (1855–1916) 353
Lowenstein, J. 71
Lowry, S. C. 371
Lucchitta, Ivo 222, 237, 245, 250, 252, 256–257
Lucey, Paul G. 326
Lucipara Ridge 187
Lucy 14, 72–73
Luine, Jonathan I. 365
Luna 3 spacecraft 331
lunar cataclysm 592
lunar crisis 576
lunar surface 584
lungfishes 99
lungs 37, 98
Luu, Jane 375
Lydekker, R. 285, 294, 299
Lyell, Charles (1797–1875) 52–53, 279, 285, 296–297, 299, 387
Lyttleton, Raymond A. 85–86, 104, 327–328, 332

M

Maat Mons (on Venus) 31
Macbeth, Norman 52
Macchetto, F. Duccio 459
Macdonald, Gordon A. 141, 146, 182, 187, 189, 254, 266, 368
MacDonald, Gordon J. F. 580
MacDonald, I. R. 143, 428
Macdonald, Ken C. 141
Mackal, Roy P. 494–495
Mackie, Richard A. 82
Macko, S. A. 372
MacLeod, Anna M. 67
macroevolution 4–6, 9, 11, 25, 53, 61, 202, 502, 527, 539
macromutation 55
Madagascar 37, 517
Madau, Piero 463
Maddox, John 60–61, 182, 328, 508
Madden, A. G. 293, 295
Mader, Sylvia S. 502
Magariyama, Y. 84
Magellan spacecraft 31
magma 118, 133–134, 156–157, 161, 169, 174, 189, 226, 265, 473
chambers 118, 167
outpourings 158, 162, 166, 168, 189
production and movement 156
magnetic anomalies 115, 123, 131, 141, 147–148, 187
fields
 Earth 26, 149, 178, 180, 192, 342, 603, 605
 secular variation 149
 stars 36, 96
linking 86

- navigation 22, 84
 reversal 115, 148
 variations on ocean floor 48, 111, 115, 138, 547
- magnetite** 180
magnetized target fusion (MTF) 405
magnetometer 148
Maguelijo, João 459
Mahaffy, P. R. 373
Mahalaleel (Adam's great, great grandson) 504–505
Maher, Brendan 80
Mahoney, Timothy P. 484
Maier, Timothy W. 47
major mountain ranges 111, 122, 124, 136, 138, 547
Makariunas, K. 419
Makovsky, Yizhaq 148
Malhotra, Renu 86, 88, 377
Malin, Michael C. 373
Malmon, Daniel V. 256
mammals
 Arctic 270, 285
 creation sequence 539
 flying (bats) 10, 25
 fossil footprints 70, 494
 fossils of 12
 frozen in Siberia 278
 marine 284
 placental-to-marsupial jump 25
 platypus 8
 transition to sea 25
mammoth 48, 111, 118, 128, 138, 266–299, 547, 559
 baby 266
 Benkendorf 272, 287
 Berezovka 266, 273–275, 277, 282, 285–287, 295–296
 Colorado Creek 269, 284, 293, 298
 Dima, a baby mammoth 266
 Fairbanks Creek 269, 284
 species of 292
 tusks 267, 269–273, 285, 288, 294
- Mandel, Ilya** 451
Mandock, Richard E. 103
Mann, Charles 55
mantle, of Earth 114, 118, 146, 164, 594
maps
 Arctic Tern migration routes 22
 continental fit proposed by Bullard 120
 continental fit to Mid-Atlantic Ridge 121
 frozen mammoth locations 268
 Grand Canyon, Grand Lake 222, 224
 Hadju Ahmed 497
 Kashmir 139
 language divergence 534
 Mercator 1569 497
 Oronteus Finaeus 497
 Piri Re'is 497, 499
 unlevel sea level 113
 western Pacific trenches 152
 world ocean floor 112
- Maran, Stephen P.** 86
Marangos, Jon 459
Maranto, Gina 82
Marble Canyon 216–217, 219, 223–226, 228, 237, 239–240, 250–251, 253, 255
Marchant, James 52, 85
Marchis, Franck 371
Marco Polo (1254–1324) 45, 106
Marcus, G. F. 59
Margot, Jean-Luc 364, 368, 376
Margulis, Lynn (1938–2011) 16, 55, 62, 66, 78
maria (lava flows on Moon) 311, 331
Mariana Trench 152
marine animals 13
- Mariner 9 and 10 spacecraft** 26, 331
marriage 540, 544, 552
Marris, Emma 107
Mars 26, 337
 asymmetric cratering 311, 331
 buried ice at poles 365
 conditions on 352, 355, 373
 craters on 374
 impacted by comets and asteroids 350, 355
 impacts by small comets not seen 318
 Lander 8
 Martian mythology 353
 meteorites not from 265, 341, 353
 methane on 533
 moons 347, 370
 no impacts by small comets 311
 orbital speed 456
 possibility of life on 8, 353, 373, 533
 salt on 314, 333
 spin 88
 underground lake on 355
 Velikovsky's claim 185
 water erosion 314, 355, 373
- Marschal, Laurence A.** 86
Marsden, Brian G. (1937–2010) 328, 334–335, 366, 484
Marsh, Bruce D. 189
Marshall, A. J. 67
Marshall, Patrick (1869–1950) 170
marshals 25, 62
Martin, C. P. 54
Martin, Larry D. 467
Martin, P. G. 332
Martin, Roy C. Jr. 91
Martin, William 66
Marx, Jean 82
Marx, Karl (1818–1883) 551
 mascons 320
Mason, Shirley L. 192
Masoretic text of the Bible 474, 483, 485, 505
mass graves, fossils in 11
Massironi, Matteo 371
Masuda, A. 422
matar (Hebrew for normal rain) 492, 519
Mather, Kirtley F. 192
Mathisen, David Warner 138, 151
Matthews, Robert 462
Mattick, John S. 80
Mavrogenes, John A. 87, 602
Maxwell, James Clerk (1831–1879) 339
Maxwell's equations 458
Maya
 360-day year 185
 civilization 213
Mayewski, P. A. 298
mayim (Hebrew for liquid water) 476, 521
Mayr, Ernst (1904–2005) 53, 56
McAuliffe, Kathleen 82
McCaffrey, Robert 187
McCarthy, John F. II
McCauley, William J. 62
McCrea, William Hunter 86, 513
McDivitt, James (McDivitt maneuver) 303
McDougall, Ian 189
McDowell, Jim 203
McDowell, Laney 395
McDowell, Lily 413
McDowell, Ryan 203
McDowell, Sean 203
McEwen, Alfred S. 373, 375
McGlynn, Thomas A. 328
McGranahan, Gordon 497
- McGuire, Rick** 53
McHardy, Gordon 62
McIntosh, Gregory C. 499
McKee, Edwin D. (1906–1997)
 proposal for the Grand Canyon 70, 211, 237, 244, 252, 256
McLaughlin, Dean 97
McNutt, Marcia 189
McSwain, M. Virginia 451
McSween, H. Y. 430
McSween, Harry V. 374
McVean, Gill 78
McWilliam, A. 463
meandering rivers (or streams) 216, 232
Mech, L. David 150
Mediterranean "Lake" 140
Mediterranean Sea 120–121, 130, 142, 151, 396–397
Meech, K. J. 329, 335
Meek, Norman 252
 proposal for the Grand Canyon 222
Meier, Roland 315, 330
Meister footprints 38
Meister, William J. 38, 99
Melia, Fulvio 96
Melosh, Jay 89, 330, 368, 377
 melting points of lead and zinc 31
 melting the inner Earth 603
Menard, H. W. (1920–1986) 177, 191
Mendel's laws 6, 52
Menoetius 350
Mercator 1569 map 497
Mercury 26, 40, 88, 456
 asymmetric cratering 311
 craters 40, 302
 ice detected 302, 365
mercury ore deposits 600
mercy killings 551
Merkel, David J. 458
Merlin, Cristine 81
Merline, W. J. 368
Merrill, G. P. 103
mesas 228–230, 247
Mesozoic rock 216
Messerschmidt, Daniel Gottlieb (1685–1735) 292
metamorphic rock 48, 111, 119, 135, 138, 342, 547
 formation of 119
metamorphosis 19–20, 81
Meteor Crater 301
meteor streams 42, 312
meteorites 301, 337, 351, 383, 385, 401, 405, 409, 411, 431, 469, 583–584
 in sedimentary rock 103
 internal heating of 341, 410
 iridium in 123
 iron 40, 320, 341, 366, 368, 474
 missing in deep sedimentary rock 311
 named
 ALH84001 353
 chondrules 351
 Monahans, Texas 351
 Murchison 343, 351, 371–372
 Murray 371
 Nakhla 265–266
 pallasites 343
 Tagis Lake 354, 374–375
 ureilites 351
 Zag 371
 not from Mars 265, 353
 not in coal 332
 only in shallow or young rock 40, 103
 Poynting-Robertson effect 105
 shallow 40, 103
 theory for frozen mammoths 280, 290
- meteorites, meteors, and meteoroids, definitions of** 337
meteoritic bombardment of Earth 28–29, 183, 603
bombardment of Moon 583
 dust 41, 104
meteoroids 48, 88, 111, 337, 341, 353, 547
meteors 301, 337
methane 31, 75, 90, 109, 116, 260, 307, 321, 325, 329, 346, 370, 473, 476, 488–489, 507–508, 532–533, 539, 598
 in comets 307, 317, 325
 on Mars 329, 532
methane hydrates 48, 111, 116, 136, 138, 142, 176, 488, 532, 547
Methuselah (oldest man on record) 505
Methuselah Tree 509
MeV (million electron volts), definition of 426
Mexican Hat, Utah 232
Mexico 120, 123, 270, 273
Meyer, John R. 255
Meyerhoff, A. A. 147, 191
Meyerhoff, Howard A. 147, 191
Micallef, Aaron 151
Michael, Henry N. 509
microagitation 211
microbe 8, 95
microdiamonds 385, 406, 421
microevolution 5, 53, 255, 502, 527
micromutation 55
microwave background radiation 91
Mid-Atlantic Ridge 114, 121, 131–133, 138, 147, 155, 222, 261, 486, 516
 birth of 486
Middendorff, Aleksandr Fyodorovich (1815–1894) 269, 297
Mid-Ocean Canyon 141
Mid-Oceanic Ridge 48, 111, 113–115, 130–131, 133, 146–147, 155, 158, 169, 517, 547
 overridden by American hydroplate 143
Y-shaped junction 114
migration 290
 of animals to Grand Canyon region 236
 of Arctic Tern 22
 of Darwin's finches 136
 of humans after flood 136, 488, 516–517, 529
 of mammoths 279
Mikkelsen, Tarjei S. 78
Mikulic, Donald G. 56, 64
mikveh (Hebrew for gathering) 555
mild ice age theory 281
Milgrom Mordehai 94
Milius, Susan 512
Milky Way Galaxy 43, 93, 106, 444–445
Miller, Hugh (1802–1856) 64
Miller, Stanley Lloyd (1930–2007) 75
Millot, Jacques 98–99
Milnes, Harold W. 458
mind, human 84
Miner, Ellis D. 88
minerals 28, 73, 95, 119, 126, 148
 minor planets (see asteroids)
miracles 559–560, 563–564
Miranda, L. F. 89, 514
missing link 25, 63, 66, 72
missing mass 94
missing trunk 12, 68
Misteli, Tom 79
Misumi, Kazuhiro 143
Mitchell, Thomas 185

- Mitchell, William C.** 91, 93
Mitchison, Avron 83
mitochondria 534
Mitochondrial Eve 534, 567
Mittlefehldt, David W. 374
Miyamoto, Masamichi 430
Moa, Wendy 164
Moho 48, 111, 119, 121, 133, 136, 422, 547, 581, 596
Mohorovicic, Andrija (1857–1936) 121
Mohr's Circle 183
mole, definition of 426
molecular oxygen 309
molecules-to-man theory 5
mollusks 12
Molnar, Peter 190–191
molten Earth 28, 31, 41, 118, 184, 518, 538, 578, 605
Monahans meteorite 351
monarch butterfly 19, 84
Monastersky, Richard 68–69, 101, 105, 142, 182, 184, 467
Mondy, Terrence R. ii, 77
monodine 218, 254
Montagu, Ashley 63, 72
Montgomery, Alan 458
Montgomery, John Warwick 106
Moodley, Yoshan 517
Moon 34, 41
amount of radioactivity 401, 414–415
compared to planets 26
core of 311
craters on 40, 302
dust 41, 56, 104, 559, 562, 583–585
Earth's 3, 27, 29–30, 40–42, 56, 86, 88–89, 103–104, 302–303, 310–311, 313, 469, 481, 576
Earth-Moon distance vs. DNA length 3
giant basins 311
hot 42, 104
ice detected 365
ice detected on 302
inclined orbit of 27
moonquakes 311, 319, 330
near vs. far side 311–312, 331
origin 29–30, 88–89
recession from Earth 41–42, 576–580
rock 583–584
search for life on 8
theories on formation 3, 27, 29–30, 42, 89
upper limit on age of 577, 579
moons in solar system
backward orbits 27
captured asteroids 346–347, 370, 377, 601
inclined orbits of captured asteroids 27
Jupiter's moons
Europa 595–596
Himalia 369
Io 321, 596
Mars' moons
Deimos 347
Phobos 347, 370
Phobos, a moon of Mars 347, 370
of asteroids 345
of comets 314
Saturn's moons
dione Dione 347
Enceladus 346, 370, 595, 601
Hyperion 377
Moore, Carleton 266, 372
Moore, Jeff 358
Moore, Patrick 95
Moorhead, Paul S. 54, 79
Moorhof, Niles 266
Morais, Helena 371
moral absolutes 553
Morales, Michael 250–251
Morell, Virginia 57, 100–101
Morgan, W. Jason 141
Morowitz, Harold J. 83
Morris, Conway 69
Morris, Henry M. (1918–2006) 71, 102, 212, 297, 449, 492, 524, 554, 562–563
Morris, John D. 106, 494
Morrison, Philip 75
Morse code 9
Morse, Gardiner 82
Mortimer, Nick 186
Morton, Glenn R. 103
mosaics 8
Moses 107, 531
Moss, Cynthia 293
mother salt layer 121, 142, 396
motors in bacteria 23
mounds, liquefaction
forming mechanism 207, 236
in southwest United States 207
water vents 207–209
Mount Ararat 45, 48, 106–107, 529, 534
Mount Everest 31, 119, 148, 158, 436
Mount St. Helens 11
mountains 489
all covered by water 48
Andes 133
Appalachian 133
Ararat 45, 107
biblical references to 3, 489
buckled 204
Cascades 136, 225
folded 117
formation of 48, 117, 133–134
formed by flood 3, 48, 111, 124, 133, 146, 547
gravity anomalies beneath 134
Himalayas, Himalayan Mountains 112, 120, 136, 139, 148–150, 225–226, 401, 412–413, 476, 503
in Siberia 286
isostatic adjustments 136
Musgrave, in Australia 207
named
Andes 133, 137
Andes, Rockies, Appalachians 133
Appalachians 133
Cascades 136, 225
Chocolate 233
Himalayas 112, 120, 136, 139, 148
Rockies 133, 221, 224, 226, 234, 239, 244, 256
named mountains 170
Appalachians 158, 208
Appennines 107
Ararat 48
Himalayas 413
Matt Mons (on Venus) 31
Mount St. Helens 11
White (California) 509
on Venus 31, 90
plateaus formed by 136
preflood 48, 129, 525, 538
Queen Maud, in Antarctica 141
rapid formation of 486
roots of 225
shells and other marine fossils on 49, 122
Table Mountain, in California 74
White Mountains, in California 509
Mscroevolution, never observed 5
mtDNA 534–535
Muav Fault 252
Mucciarelli, A. 93
muck 271–272, 274–276, 280–291, 294
Mueller, Kristen 366
Mulfinger, George Jr. (1932–1987) 105, 546
Mullen, George H. 90
Muller, P. M. 335
multiplication of languages 515
Mumma, Michael J. 329
Mumma, Stanley A. 1
Munk, Walter H. 580
Murchison meteorite 343, 371–372
Murray meteorite 371
Murray, Bruce 331
Musser, George 92
mutation 5–7, 18–19, 53–56, 59, 79, 81, 83, 534, 536, 549
Muyzer, Gerard 101
mycoplasmas 61
myrmekite 389, 406, 408, 424
Myrow, Paul M. 432
mythology 494, 518, 524
- N**
- Nabiei, Farhang** 368
Nadis, Steve 94
Nagy, Laszlo 74
Nakamura, Tomoki 371
Nakamura, Yosio 331
Namouni, Fathi 371
Nampa image, out-of-place artifact 39, 102
Nance, Rod 192
Nankoweap
Canyon 217–219, 228, 237, 239–245, 250
Creek 218–219, 241
Delta 218, 241
Mesa 217, 219, 228
nanotechnology 84
Napier, Bill 335
Napier, W. McD. 321
Narayanan, Desika 453
Narlikar, Jayant V. 91, 106
Narmada man 72
NASA 308, 583
natah (Hebrew for stretched) 439
Natarajan, Priyamvada 451
Nathues, A. 368
National Geographic 466
National Institute of Standards and Technology 457
national science standards 566
Native Americans 529
Native Americans living in the Arctic 527
Natland, J. H. 189
natural environment 7
natural processes 5, 7, 9, 18, 32, 36, 57, 61, 83, 90, 100
natural selection 6–7, 18, 53, 55, 57–58, 65, 68, 81, 199, 527, 529, 540, 549
Navajo Bridge 224
Navajo legend for Grand Canyon 256
navigation 20, 22
Neanderthal man 14, 73
near-parabolic comets 306–307, 312, 314
Nebraska man 13–14
Nebuchadnezzar II 484
Nelson, Byron Christopher (1894–1972) 107
Nelson, Ethel R. 48, 107
Nemchin, Alexander A. 421
neon 353
Neptune 26–27, 29, 88, 105, 323, 332, 335
heat from 42
moons of 346
Nettleton, L. L. 142
neutrinos 94, 382, 419
neutron activation analysis 382, 400
neutron stars 382, 420
Neuville, H. 293
Nevins, Stuart E. (alias of Steve Austin) 103
new age movement 552
New American Standard Bible iv
New England Seamounts 190
New Hebrides Trench 152, 174
New Horizons spacecraft 358, 376
New Mexico 140
New Orleans 495
New Zealand 123, 494, 517
Newberry, John Strong (1822–1892) 221, 252
Newell, Norman D. 68
Newfoundland 196
Newton, Hubert Anson (1830–1896) 327
Newton, Isaac (1642–1727) 56, 281, 315, 326, 334, 567
Niagara Falls 227, 240
Nicholson, Thomas D. 328
Nickel, Bryan 109, 215, 250
Niemann, H. B. 533
Nier, Alfred O. 421
Niessen, Richard 543
Niigata, Japan, earthquake at 194
Nilamata Purana (book of Hindu legends) 139
Nilsson, Lennart 21
Nilsson, Nils Heribert (1883–1955) 54–55, 62
Nimrod (notorious great grandson of Noah) 517
Ninety East Ridge 112, 149–150
Nisan 555
nitrogen 14–15, 74, 275, 506, 519
no rain before the flood 475, 478
No Seafloor Spreading 176
Noah 485, 494, 499, 505, 516, 518, 525, 529–530, 534–535, 554–555
Noah's Ark 45–47, 106, 534, 540
Does it exist? 45
Noah's flood 151, 567
Noé, A. C. 70
Nolan, Edward J. 70
Nomura, Ryuichi 183
nonliving matter 5
Noorbergen, Rene 102, 106, 499
Nordenskiöld, A. E. 292, 295
Norman Meek and John Douglass proposal for the Grand Canyon 222
Norman, J. R. 69
Norman, Trevor 458
Normandy, banks of 259
North America 65, 69, 111, 115, 119, 155, 270, 274, 298, 517
North Canyon 225
North Pole, preflood 136, 149–150, 281
Northrup, Bernard E. 516–517
Norton, O. Richard 366, 368, 371, 474
Norway 142
Noulton, Forest 513
Novotny, Eva 95
nuclear combustion 384, 400
nuclear reaction 459
nuclear reactor 378, 380, 382, 386, 401, 404–406, 422, 430
nucleation 394, 427, 520
nucleons 379–380, 398–400, 418, 429
nucleotide 18, 61, 80–81
nucleus
of a cell 534
of a comet 302–304, 307, 310, 314–315
of an atom 398–400, 402–403, 407, 418–419, 428–429

- ▲
O
- O stars** 36
- O'Connell, Patrick** 72
- O'Donoghue, James** 88
- O'Hara, Sean** 377
- O'Rourke, Daniel J.** 525
- O'Rourke, J. E.** 98
- Oak Creek Canyon** 227
- Oard, Michael J.** 142, 289–290, 297–299, 562, 564
- Obolensky, Alexis Guy** 458
- observatory**
- Kitt Peak National** 513
 - U.S. Naval** 455
- ocean floor** 25, 40, 113–116, 133, 136, 140–141, 158, 489
- ocean floor maps** 112, 152
- ocean trenches** 3, 48, 111, 114, 138, 152–153, 158–192, 547
- Oceanic Layer 3** 187
- Odyssey spacecraft** 374
- Officer, Charles** 143
- Ohlmeyer, Harold Z.** 499
- Ohno, Susuma** 79
- Ohta, K.** 463
- oil formation** 48, 109, 111, 116, 129–130, 260, 476, 488, 507, 547
- Oklo Natural "Reactor"** 386, 401, 404–405, 422
- old DNA, bacteria, and proteins** 38, 100
- Old earth beliefs, based on unreasonable assumptions.** 36
- Olduvai Gorge, Tanzania** 72
- Olgas (in Australia)** 207
- olivine** 122, 171, 308, 311, 314, 329–330, 343
- olivine in comets** 329
- Ommanney, Francis Downes** 67, 98–99
- on 41**
- ontogeny recapitulates phylogeny** 63–64
- Ontong-Java Plateau** 118
- Oort cloud** 363
- Oort cloud theory** 307, 312–313, 321–324, 327–328, 332, 334–335
- Oort, Jan Hendrik (1900–1992)** 307, 315, 332
- Opadia-Kadima, G. Z.** 53
- Öpik, Ernst Julius (1893–1985)** 315, 323, 334–335
- Oppenheimer, Rebecca** 106
- orangutan** 536
- orbital time** 455, 457, 459
- orbits**
- of asteroids** 339, 341
 - of binary stars** 34
 - of comets** 42, 315
 - elliptical** 304–305, 307, 312, 327
 - hyperbolic** 305, 307, 312, 328
 - near-parabolic** 306–307, 312, 314
 - parabolic** 305
 - of moons** 27, 29–30
 - of planets** 27
- ore bodies** 547
- ore deposits** 596, 600, 602
- organ of Corti** 62
- organic evolution** 5, 25, 51–52, 64–65, 69, 77, 178, 296, 524
- organisms, distinct types** 7–8, 15, 58
- Orgel, Leslie E.** 80
- origin of**
- angiosperms (flowering plants)** 67
 - asteroids** 336–374
 - Ayers Rock** 207
 - birds** 67, 464–467, 539
 - chemical elements** 93
 - chordates** 69
 - coal and oil** 130
 - comets** 300
 - Earth's magnetic field** 178, 180, 192, 342
 - Earth's radioactivity** 378–433
 - fishes** 69
 - fossils** 128
 - genetic code** 81
 - geothermal heat** 134
 - Grand Canyon** 138–257
 - humans** 68
 - immune system** 82
 - inner and outer core** 155, 603
 - iron meteorites** 366
 - language** 8, 60
 - life** 15, 51, 61, 75–77, 80–81, 83
 - limestone** ??–234259–266
 - metamorphic rock** 135
 - meteorites** 336–374
 - methane hydrates** 136
 - Mid-Oceanic Ridge** 130
 - moon** 29, 86, 88
 - muck** 276
 - ocean trenches** 152–192
 - planets** 85
 - plants** 68
 - plateaus** 136
 - solar system** 85–86
 - stars** 96
 - strata and layered fossils** 194–213
 - submarine canyons** 136
 - tablemounts** 169
 - vertebrates** 67
 - water on Earth** 27–28, 42, 86, 328
 - zodiacal light** 105, 342
- origins research project** 548, 557
- Ornes, Stephen** 515
- Oronteus Finaeus map** 497
- Oroseli, R.** 375
- Orosz, Jerome A.** 514
- Ortiz, L. L.** 375
- Orville, Philip M.** 142
- Osborn, Henry Fairfield** 56, 71
- osculating period, of comets** 484
- osmosis** 502
- Osorio, M. R. Zapatero** 515
- Osterloo, M. M.** 333
- Ostro, Steven J.** 371
- Ostrom, John H.** 466
- Ott, Ulrich** 371
- outer core of Earth** 155
- outer space** 458, 518, 525, 532–533
- out-of-place artifacts** 39
- out-of-sequence fossils** 13, 70, 136
- out-salting** 126–127, 261, 396, 411
- Ovcharov, V. V.** 70, 495
- overlapping spreading centers** 114, 141, 146–147
- overthrusts** 48, 70, 111, 118, 131, 138, 204–205, 547
- Owen, Robert** 77
- Owen, Tobias C.** 330
- Oxnard, Charles E.** 72
- oxygen** 14–15, 38, 74–75, 275, 283, 298, 353, 506, 519
- Ozima, M.** 331
- ozone** 14
- ▲
P
- Pääbo, Svante** 100
- Pacific Ocean** 114, 118, 135, 155, 158–159, 168, 182, 496
- Page, Arizona** 140
- Page, Don N.** 90
- Page, Jake** 143
- Pakistan** 139
- paleontologist** 25, 53, 64–66, 98
- paleontology** 65–66, 98
- Paley, William (1743–1805)** 57
- Pallas, Peter Simon (1741–1811)** 343
- pallasites** 343–344
- Palmer Peninsula, Antarctica** 499
- Palmer, Craig T.** 553
- Palmer, Ralph S.** 293
- Paluxy River, footprints** 494
- Paneth, F. A.** 103
- pangensis** 51
- panspermia** 75
- Pappas, T.** 458
- parabolic orbits** 305
- paradigm shift** 250, 325
- parallel strata (layers)** 12, 39, 102
- parasite** 11, 21
- Paris gun, of World War I** 395, 582
- Park, Alice** 512
- Park, R. S.** 365
- Parker, Eric T.** 75
- Parker, Eugene N.** 75
- Parkes, R. John** 101
- Parkhomenko, E. I.** 426
- parsimony** 123
- Parsons, Thomas J.** 536
- Pascal, Blaise (1623–1662)** 567
- Pasteur, Louis (1822–1895)** 51
- patriarchs** 505
- Patrusky, Ben** 92
- Patten, Donald Wesley** 504
- Patterson, C. Stuart** 1, 265–266
- Patterson, Colin (1938–1998)** 65, 67, 77
- Paunsaugunt Fault** 252
- peanut-shaped asteroids** 348
- Peartree, Philip A.** 256
- Peebles, James** 94
- Peebles, P. J. E.** 97
- peer review** 561
- peer-review journals** 561
- Peet, Stephen D.** 107
- pegmatites** 389–390, 401–402, 407, 414, 424
- Peking man** 14
- Peleg** 515–517
- peleg (Hebrew for divided by water)** 516
- peneplains** 243, 256
- Pennisi, Elizabeth** 64, 78
- Penniston, John B.** 296
- Penrose, Eric** 53
- Pentateuch** 522
- Penzias, Arno** 400
- Pepin, O. O.** 374
- Pepys, Samuel** 334
- perihelions** 304, 310, 313, 321–324, 483
- Perkins, Sid** 62, 252, 370, 422, 499
- personal responsibility** 552
- Peru-Chile Trench** 191
- Peruvians, 360-day year** 185
- pesticide** 7
- petaFLOP (extremely fast) computers** 57
- Peter the Great** 292
- Peterson, Ivars** 57, 92, 96–97, 210, 451, 461
- Petford, N.** 188
- Petit, Charles** 89
- petrification in Grand and Hopi Lakes** 265
- petrified forests** 13, 228, 230–232, 236, 247, 250, 255, 265
- Petterson, Hans** 104, 562
- Pettit, Jean-Marc** 376
- Péwé, Troy L.** 251, 296, 298–299
- Pfizenmayer, E. W.** 285, 293–295
- phenotype** 62
- Philippine Trench** 152
- Philippines** 517
- Phillips, Roger J.** 432
- Phillips, Thomas J.** 453
- Phillips, W. D.** 459
- Phobos** 347, 370
- Phobos, a moon of Mars** 601
- Phoebe, a moon of Saturn** 27
- phosphate beds** 13
- photosynthesis** 25, 123, 543
- phyla** 12, 25, 69
- pictographs, Chinese** 48, 107
- Pierce Canyon** 250
- Pierce, Michael J.** 95
- Pierson, Rick** 76
- piezoelectric effect** 378–379, 391, 400, 408, 414, 418, 510, 597
- pig's tooth in Nebraska "man"** 14
- Pigeon Canyon** 256
- pillars in subterranean chamber** 124, 126, 231, 312, 338, 341–342, 345, 390–391, 410–411, 415, 469–472
- Pitldown man** 14, 71
- Pineda, Jaime E.** 450
- ping-pong ball analogy** 173, 176
- Pink Cliffs** 225
- Pioneer 10 and 11 spacecraft** 26, 342, 366
- Piri Re'is map** 497, 499
- Pirke de Rabbi Eliezer** 470, 474
- Pishon, a pre-flood river** 478
- Pithecanthropus erectus*** 72
- Pitman, Michael** 20, 55, 63, 67, 75, 81–83
- Pitman, Walter** 151
- Pixie, N. W.** 82
- placebo** 432
- placentals** 62
- plagioclase feldspars** 389, 406, 408, 414, 424
- Planck's constant** 456
- planetary nebula** 31, 96
- planetary rings** 29–30, 88, 347
- planetesimals** 87, 365
- planets** 26, 51, 74, 76, 79, 84–88, 97, 105, 456, 458, 519, 532, 554
- angular momentum of** 27
 - backward orbits of their moons** 27
 - backward-spinning** 27
 - difficulty evolving** 29, 31, 87, 321, 335
 - Earth** 26–27, 29–32, 34, 36–43
 - formation** 27, 29–31, 34, 85, 87, 440
 - free-floating** 514
 - gaseous** 29
 - giant** 29
 - gravitational attraction** 42
 - hot** 42
 - inclined orbits of their moons** 27
 - Jupiter** 26–27, 29, 42, 88, 105, 327
 - Mars** 8, 26, 40, 88, 456
 - Mercury** 26, 40, 88, 456
 - minor planets (see asteroids)**
 - Neptune** 26–27, 29, 42, 88, 105, 332
 - non-spinning, if they evolved** 29
 - outside the solar system** 513
 - Pluto** 26–27, 332
 - rocky** 29
 - Saturn** 26–27, 29, 42, 88, 105, 305
 - strange planets** 27
 - unique planets** 26
 - Uranus** 26–27, 29, 42, 82, 88, 332
 - Venus** 26–27, 31, 40, 42, 88, 90, 105, 456, 519
- Plant, J. A.** 422
- plants** 69, 82, 100, 538
- amino acids in** 18–19
 - at polar latitudes** 271, 273–274, 285, 289
 - biblical references to** 538–539
 - bioluminescence in** 25

- buried in flood 12, 260
carbon-14 in 506, 508
DNA 38, 100
edible 541
first 539, 541, 544
flowering 12–13, 123, 539, 544
fossil gaps 12
fossil record 66
fossilization of 122, 129, 518
found in mammoth's stomach 274, 285
immune system of 22
in rock ice 274–275
in yedoma soil 275
index fossils of 37
left and right handedness 19
marine 25
mutations 54
origin of 68
photosynthesis 543
poisonous 19, 541
pollen-bearing 21
radiocarbon dating of 506
reestablished after flood 50, 262
relating to canopy theory 518
sexual reproduction in 20
symbiotic relationships 21
transitional 65, 539
tropical 520
vascular 12, 25
yucca 21
- plasma** 384, 391–393, 405–406, 425
plate tectonic theory 69, 113–114, 140–141, 147, 153–154, 515
coal in Antarctica 116
explanation for Grand Canyon 244
explanation for trenches 162, 166
fracture zones 114, 147
heat as basic driving mechanism 162
lacking explanations 111, 141
magnetic anomalies 115
overlapping spreading centers 114
plate movements 141
plate thicknesses 162, 174
push, pull, and drag 168
triple junctions 178
- plateaus** 48, 111, 119–120, 136, 238, 547
Colorado 119–120, 136, 216, 220–222, 224–226, 234, 236, 238–240, 242–245, 252, 256
Columbia 135–136, 225
Deccan 118, 135
definition of 119, 252
formation of 119, 136, 225–226
Kaibab 215–216, 220–222, 226, 228, 237, 240, 242–245, 248, 253
problems forming 119
Tibetan 118, 120, 134, 136, 148, 225, 473, 475, 493
- platinum** 600
Platt, Rutherford H. 525
platypus 7–8, 62
plesiosaur 25, 494
plumes 162, 167, 188–189, 195, 206–207
plutinos 357
Pluto 26–28, 323, 332, 358–360, 362–364
Pluto, Is it a planet? 28
Poggiali, Valerio 533
Poinar, George O. Jr. 100
Poinar, Hendrick N. 100
Poirier, J. P. 190
Poirier, Jules H. 81
polar moment of inertia 182, 603
Poliakov, Alexei N. B. 184
poling 391–392, 400, 402
pollen 13, 20–21, 71
Pollitz, Fred F. 182
Pollock, J. A. 393
polls 557–558, 566
polonium halos 387–389, 401, 406–408, 423–424
- Polynesian Islands** 517
polystrate fossils (trees) 11
Pontus, Skoglund 517
pooled water under mountains 134
Popov, A. I. 295
Popov, Y. N. 296
population II stars 93
population III stars 32, 93, 462
Porco, Carolyn 370
Porfir'ev, V. B. 602
porpoise 23
positron, an electron's antimatter 34
Post, Vincent E. A. 141
Postberg, Frank 369–370
postflood
carvings of mammoths 291
continents 473
lakes 138, 265, 502
rivers 475
- potassium** 383, 403–404, 409
potassium-argon dating 243, 256, 403
potential energy 306
potholes 223, 253
Powell, Corey S. 97, 375, 419
Powell, James 418
Powell, James Lawrence 256–257
Powell, Jerry A. 82
Powell, John Wesley (1834–1902) 216, 221, 240, 242, 252
- Powers, Pam** 251
Poynting-Robertson effect 42, 105, 312
- Precambrian** 203, 207
fossils 68
rocks 13, 203
- precession** 86, 136, 149
precession of the equinoxes 138
precipitation 140
precision vs. accuracy 457, 459
predator 58, 69
predictions as test of scientific theory 123, 438
- predictions of evolution**
abundance of elements 92
background radiation 91
based on the big bang theory 91
evolving new features 6
fracture zones 147
genetic distances 77
helium to hydrogen ratio 92
life on Mars 353
life on Mars, by Carl Sagan 8
moon dust 104
no fossil gaps 25, 296
no soft-bodied fossils 64
planetary formation 85
too much beryllium 93
- predictions of hydroplate theory**
1. Super-rotation on Venus 128
2. pooled water under mountains 134
3. salty water in very deep cracks 134
4. many fossilized whales 137
5. hidden canyons 140
6. magnetized fracture zones 148
7. magnetic intensity at smokers 148
8. Earth is shrinking 162
9. earthquakes will be predicted 164
10. granite under Pacific floor 170
11. fossils in and near trenches 170
12. inner core decelerating 185
13. age of Hawaiian islands 189
14. thin varves not under lakes 201
15. sand dunes from Grand Canyon 233
16. chemistry of lake basins 236
- 17. slot canyons, deep cracks** 238
18. inner gorge is a tension crack 240
19. fault under monocline 254
20. loess at bottom of ice cores 282
21. muck on Siberian plateaus 282
22. rock ice is salty 282
23. bubbles in rock ice 283
24. muck particles in rock ice 283
25. no fossils below mammoths 283
26. radiocarbon dating mammoths 284
27. ice age could be demonstrated 298
28. CO₂ dissolved in comet ice 308
29. salt on Mars 314
30. moons around some comets 314
31. mass of solar system 317
32. strange comet pairs 317
33. heavy hydrogen in deep water 318
34. salt and bacteria in comets 318
35. no Oort cloud 328
36. no incoming hyperbolic comets 328
37. argon only in comet crust 329
38. asteroids are rock piles 338
39. rounded rocks in space 338
40. fast spinning asteroids 338
41. asteroid rocks are magnetized 343
42. deuterium in asteroids 344
43. water is inside large asteroids 344
44. mining asteroids too costly 344
45. Deimos has a very low density 347
46. air deposit of Mars' sediments 356
47. deuterium in asteroids 356
48. irregular moons are like TNOs. 356
49. many TNOs have rings. 357
50. no planet X found by 2021 364
51. comets are rich in oxygen-18 411
52. lineaments, earthquake risks 412
53. little radioactivity on Moon 415
54. reionization will not be seen 441
55. carbon-14 in "old" bones 508
56. bacteria on Mars 532
57. H deficiency in halo inclusions 607
- preflood**
atmosphere 14–15, 282, 520–521, 539
canopy 520
crust 522
Earth 124
forests 507
mountains 48, 479, 485, 489, 525, 538
patriarchs 505
rivers 535
- Prevot, M.** 141
Pribnow, Dan F. C. 422
Price, George McCready (1870–1963) 102, 212
Price, Huw 90
Pride, Mary 1
Priest, F. G. 100
Prigogine, Ilya 90
primates 12, 68, 72–73
principles of evolutionary geology
superposition 200
uniformity 200
- Prior, G. T.** 103
Priscu, John 499
Prochaska, Jason X. 463
Proctor, Richard A. (1837–1888) 315, 334
prograde orbits 304–306, 310, 312, 315, 317, 321–322, 324, 327
programs in genetic material 9
- progressive creation** 537
prokaryotes 12, 66
propellers in bacterial motors 84
proteins 15, 18, 22, 39, 54, 62, 74, 76–77, 81–83, 101
Proton-21 Electrodynamics Research Laboratory 384, 418, 429
Proto-Uranium 382, 409, 546
prove, a word to avoid 556
Ptolemy, Claudius Ptolemaeus (ca. A.D. 100–175) 141
public opinion 19, 309, 369, 422, 439, 597
public schools 438, 544, 557, 566–567
Pulinets, Sergey 188
punctuated equilibrium 66
-
- Q**
- Qiu, Jane** 182
Quackenbush, L. S. 295
Quaglioni, Sofia 429
quanta 457
Quaoar 356
quarry 130
quartz 385, 389, 391–392, 401–402, 406, 408, 414, 418, 424, 426
quartzite 203
quasars 32, 43, 442, 444, 446, 451–452, 462–463
- Queen Maud Land, Antarctica** 497, 499
Queitsch, Christine 51
quicksand 195, 210
Qur'an 567
-
- R**
- raah (Hebrew for appear)** 543
Rabinowitz, D. L. 370–371
race, human 527–529
racism 529, 552
radiation of heat 280
radio telescope 533
radioactive decay 39, 41–42, 111, 162, 378–379, 381–383, 385, 387–390, 392, 398, 402–409, 411–412, 414–415, 418–421, 424, 427, 430, 506, 547
radiocarbon 256, 269, 284, 293, 383, 432–510, 517
radiocarbon dating 380, 409–509
radiohalos 387–389, 423
radioisotopes 379, 382, 387–388, 408
radiometer effect 337, 339
radiometric contradictions 97
radiometric dating 36, 415, 432, 461–509, 517
Radiophysical Research Institute 455
radon 388–389, 399, 407, 424, 428
Raff, Arthur D. 141
rain 260, 475, 478–479, 485, 488–490, 492, 519–520, 525
rainbow 475
raindrops 475, 477, 520
Ralph, Elizabeth K. 509
Rama Ridge 187
Ramakrishnan, Venki 76, 512
Ramapithecus 14
Ramdohr, Paul A. (1890–1985) 97, 390, 408, 424
Ramsayer, K. 368
Ramsköld, L. 69
Ranger spacecraft 41
Ranney, Wayne 250–252, 255–256
rape 553
rapid burial 11, 64, 489
rapid cooling 41
raqa (Hebrew for spread out) 522–523
raqia (Hebrew for expense) 521–522,

- 526
Rashi Commentary 471, 522
Rasio, frederic A. 514
Rastall, R. H. 98
Rauch, M. 463
Raup, David M. (1933–2015) 63–65, 70, 76, 98, 143
reasoning 36, 98, 123, 135, 532, 548–549
Reasons to Believe, Hugh Ross 559
Reck's skeleton 14
recovery phase 136, 138
Red Butte 236
Redmond, Ian 293–294
redshift 32, 43, 91, 106, 455–457, 459, 463
Redwall Limestone 264
Reeh, Niels 298
Reese, Kenneth M. 150
Reeves, Hubert 329
Regenauer-Lieb, Klaus 191
regolith 584
Rehman, Ejaz ur 430
Reich, Eugenie Samuel 451
Reid, Archdall 52
Reisz, Robert R. 101
relativism 552
remanent magnetism 342
Ren, Dong 71
Renée, James 452
Renfrew, Colin 535
Rensberger, Boyce 73
Repetski, John E. 69
reproduction (see sexual reproduction) 20
reproduction cycle 6
reproductive success 58–59, 553
reproductive system 20, 67
reptiles 7–8, 12, 15, 25, 62, 67, 464, 466–467, 494, 539
 flying (pterosaurs) 10, 25
residual magnetism 34
resistance to pesticides 7
resistant bacteria 7, 53
Restak, Richard M. 85
restitution interpretation 530
retrograde orbits 305–306, 310, 315, 321–322, 324
revelation theory 537, 543
Revelle, Roger 182, 191
Reynolds, Christopher S. 451
Reynolds, Osborne 339
Reznick, David 57
rhinoceroses, frozen 267–274, 276–277, 279, 282–284, 286, 288–289, 293
rhyolite 402
ribosomes 15, 510–512
Rice, R. J. 250
Rich, Thomas H. 62
Rich, Vera 294, 299
Richards, Paul G. 184
Richardson, Derek C. 365
Richardson, Michael K. 64
Richardson, Randall M. 189
ricketts 14, 527
Rider Canyon 251–252
Riess, Adam 91
rifts (axial or flank) 146, 148
Righter, Kevin 86
Riley, J. P. 103
Rincon, Paul 188
Ring of Fire 135, 152–153, 157–158, 162, 164–165, 170
ring rain 29
rings of planets 29–30, 88, 347
Rio Grande 244
river delta 196, 200
river sediments 40, 103
rivers of Eden 535
 Euphrates 478
 Gihon 478
 Pishon 478
 Tigris 478
Rivkin, Andrew S. 367
Rizo, Hanika 416, 433
RNA 15, 18
Roan Cliffs 225, 236, 253
Roberts, N. 62
Robertson, Stephen J. 105
Robinson, Leif J. 93
Roche's limit 580
rock ice 274–276, 279, 281–284, 286–291, 298
Rock Point, Arizona 234
Rocky Mountains 133, 221, 224–226, 234, 239, 244, 256
Rodriguez, Diego 526
Rogers, Garry 183
Rohde, Douglas L. T. 536
Rohsenow, Warren M. 212
Roman
 360-day year 185
 mythology 524
Romance languages 534
Romashko, Alexander 70, 494
Rose, H. J. 419, 508
Rose, Michael 82
Rosen, Julia 191
Rosen, Meghan 70, 104, 585
Rosenbaum, M. 526
Rosetta spacecraft 309, 320, 325
Roska, Botond 55
Rosnau, Paul O. 70, 494
Ross, Hugh 449, 559, 562
Ross, Philip E. 60
Rosswog, Stephen 429
Roth, Ariel A. 97, 103, 190, 212, 335
Rothschild, Bruce M. 73
Roush, Wade 509
Rouster, Lorella 495
Rowan-Robinson, Michael 97
Rowe, Jack J. 255
Roy, Mousumi 252
Roy, Robert F. 422, 429
Royal Society of London 334
Ruben, John A. 67
Rubey, William 212
Rubin, Alan E. 367, 431
Rubner, Michael 266
Rudwick, Martin J. S. 299
ruin-reconstruction theory 530
ruminants 532
runaway greenhouse effect 30, 160, 520, 563, 609
rupture phase 125, 131–133, 138, 146
Rusch, Wilbert H., Sr. 64, 102
Rush, David E. 562
Russell, Bertrand 85
Russell, Henry Norris (1877–1957) 315
Russia 118, 135, 266–267, 273, 292–294
Russian pilot (claimed Ark sighting) 46
Ryabchun, V. K. 295
Ryan, Eileen V. 329
Ryan, William 151
Ryder, Oliver A. 536
Rye, Rob 89
Rygg, J. R. 426
Ryukyu Trench 152
- ▲
S
- Saal, Alberto E.** 331
Saey, Tina Hesman 78
Saffran, Murray 557
Safronov, Viktor 513
Sagan, Carl (1934–1996) 8, 16, 78, 90, 185, 325–328, 353, 569
Sage, Leslie 441, 450
Sahli, Jim 329
Salisbury, Frank B. 55, 83
Salisbury, Rollin D. 487
Salmonella 23
salt dome 48, 111, 121, 130, 547
 formation of 130, 138
Salt Lake 121, 138
Salton Sea 233
saltwater fish 502
Samaritan Pentateuch 474, 483, 512
Sambles, Roy 56
Samuel Franklin Emmons
 proposal for the Grand Canyon 221
San Andreas Fault 111, 155, 186
San Francisco 140
San Juan River 232–233
Sanchis-Ojeda, Roberto 450
sand dunes 232–233, 242, 250
Sanderson, Ivan T. 294, 296, 299
Sandford, Scott A. 325
Sandia National Laboratory 378
sandstone
 cross-bedded 195, 207–208
 layered 206
 plumes 206
 St. Peter 200
Sandwell, David T. 141
Sanford, John C. 55, 61
Santorum, Rick 550–551
Sarmiento, J. L. 266
Satan 530
Sato, Mariko 186
Satterfield, Cindy L. 101
Saturn 26–27, 29, 88, 105, 305, 327
 heat from 42
 moons 346–347, 376
 moons of 27
 rings 347
 rings of 29–30, 88
Saturn's moons
 Enceladus 595
 Phoebe 27
Saunders, A. D. 422
Saunders, Will 92
Sawyer, Douglas J. 266, 372
Sawyer, Kathy 373
Saxena, Surendra 192
Scadding, S. R. 62
Scalia, Antonin 567
Scandurra, Marco 366
Scanlon, Kathryn M. 431
Scarborough, R. B. 248, 257
Schaeffer, Bobb 98
Schenk, Paul 370
Scherer, Siegfried 536
Schiaparelli, Giovanni Virginio (1835–1910) 315, 353
Schilling, Govert 91, 459
Schilpp, Paul Arthur 85
Schindel, David E. 66
Schlanger, Semour O. 184
Schliwa, Manfred 83
Schmitz, Birger 372
Schneider, Stephen E. 106
Schoenfield, Jon vi, 417
Scholl, David William 177, 191
Schoolcraft, Henry R. 99
Schopf, William J. 74
Schulman, Edmund 509
Schulz, Rita 331
Schwabe, Christian 77
Schwamb, Megan E. 359, 377
Schwartz, Karlene V. 62, 66
Schwarz, Dominik J. 92
Schweitzer, Mary H. 101
Schwinghammer, Gregor 48
Sciama, D. W. 93
science
 defined 438
 education 567
 fiction 532–533
Scientific dating techniques that show a young Earth 39
scientific debates 109, 436, 438, 526, 545, 566, 569
scientific evidence, defined 438, 493
Scopes Trial 436
Scott, Donald E. 418
Scott, Samuel 145
seafloor spreading 162, 168, 176
Seager, Sara 515
seamounts, tablemounts 138, 154, 158, 165
Sears, James W. 254
Sears, R. L. 97
second law of thermodynamics 32, 61, 90–91
secular humanism 544, 552
secular variation of the magnetic field 149
sedimentary
 layers 11–12, 39, 48, 198–200, 203, 207, 211, 524
 rocks 12, 75, 103, 119, 195, 198
sediments 118–119, 122, 128–130, 132, 136, 140, 147, 158, 195–203, 210–211
Seelert, Holger 84
Segraves, Kelly L. 84
Segura, Teresa L. 374
Seife, Charles 399, 429
seismic tomography 154, 170, 180, 182
seismic waves 182
seismometers 154
Sekanina, Zdenek 333, 335
Selbrede, Martin G. ii
selective breeding 551
selfish behavior, How could it evolve? 8
Selim, Jocelyn 299
Selley, R. C. 142
Sellier, Charles E. 106
Sen, J. 69
Sender, R. 78
senders and receivers 9
Seneca, Lucius Annaeus (4 B.C.–A.D. 65) 315
separation of church and state 567
Septuagint text of the Bible 474, 483–485, 504–505, 512, 522
Service, Robert F. 81–82, 101
Seth (son of Adam) 505
Seth, Anil C. 452
Setterfield, Barry 142, 454, 458
Setton, Dolly 429
Sevier Fault 252
sexual reproduction 20–21, 82
Seyfert, Carl K. 141
Seymouria 67
Shackleton, Ernest Henry 141
shale 130
shallow meteorites 40
shamayim (Hebrew for heaven) 471, 522
shaphrur (Hebrew for canopy) 522
Shapiro, Ascher H. 582
Shapiro, Robert 75–76, 81
shatter cones 341
Shaw, G. 74
Shawver, Lisa J. 56
Shearer, Peter M. 187
shearing stress 183
sheet flow 216, 240
Shelah (great grandson of Noah) 504–505
Sheldon, Peter R. 52
Shem (son of Noah) 505, 510, 529, 554
Sheng, George 255
Sheppard, George 213
Sheppard, Scott S. 361, 370, 377

- Sheth, H. C.** 189, 191
shifting vs. drifting 153
Shiga, David 453
Shigeru, Ida 89
Shinumo Altar 231–232, 234, 245–246, 255
Shipman, Pat 70
Shkolikov, P. L. 426, 430
shock collapse 392, 405, 413–414
Shockey, Don 107
Short, Nicholas M. 104, 190, 331
short-period comets 327
Shoshani, Jeheskel 292–294, 299
Showalter, Mark 376
Shreeve, James 73
Shroud of Turin 432
Shtarkman, Yuri M. 499
Shu, D. G. 69
Shu, Frank H. 96
Shubin, Neil 70
siach (Hebrew for *shrub*) 479
Siberia 118, 267, 271–276, 278–280, 283–289, 292–296, 298, 495
Sickafoose, Amanda A. 375
side canyons to Grand and Marble Canyons 217, 219
siderite, missing in ancient soils 89
Siegler, M. A. 481
Sigleo, Anne C. 255, 266
Sigmund, Karl 59
Sigurðsson, Steinn 514
Sigwarth, J. B. 330
Silberman, A. M. 526
silica 126, 478
silica, in solution 207, 228, 231, 236, 238, 255, 265
Silk, Joseph 93, 97, 106, 429, 433
Silva, Lucas C. R. 498
silver ore deposits 600
Simons, Lewis M. 467
Simpson, George Gaylord (1902–1984) 60, 63, 65
Simpson, Richard A. 88
sin and death 542
Singham, Mano 551
single-cell 12, 63
sink
 holes 225, 251, 253, 260
 valleys 224–226, 228
Sirkin, Leslie A. 141
Sjogren, W. L. 335
skin color 527, 529
Skinner, Brian J. 190, 296
Skipper, Magdalena 499
Skirrow, G. 103
slab 464–465
slot canyons 217, 219, 237–238, 240, 242, 250
slowly spinning sun 440
slow-slip earthquake 155, 172, 181
Sluijs, Appy 151
Slusher, Harold S. 97, 103–105, 297
small comets 42, 104, 310–312, 315, 318
Smith, Bruce D. 509
Smith, E. Norbert 502
Smith, Homer W. 67
Smith, J. L. B. 37, 99
Smith, Jesse 459
Smith, John Maynard 82
Smith, Peter H. 333, 374
Smith, William (1769–1839) 97
Smoot, N. Christian 191, 500
Smothers, James F. 63
Snelling, Andrew A. 70, 563, 602
snow geese 527
social consequences of belief in evolution 551
social Darwinism 552
solar eclipse 30
solar sails 362
solar system 26–27, 29–31, 39–40, 42, 84–88, 104–105, 307, 327–328, 533
solar wind 28, 42, 105, 302, 328–329, 583
solid tide 595–596
Solomon, Hebrew king 483
Solzhenitsyn, Alexander 278
sonar system 23
Song, Xiaodong 184
Song, Young Hun 543
Songaila, Antoinette 95
Sorensen, Herbert C. 509
South Africa 37
South America 497
South Carolina 13
South Hebrides Trench 152, 174
South Pole 116
South Solomon Trench 152
Sovetskaya Lake 150
Sozansky, V. I. 602
space, time, and matter 31, 90
spacecraft
 Apollo 26, 326, 331, 580, 583
 Cassini 346, 370, 376, 595
 Deep Impact 308, 326, 348
 DEMETER 188
 Dynamic Explorer 42
 Galileo 336
 Giotto 303, 325
 GRACE 154
 Hayabusa 348
 Luna 3 331
 Magellan 31
 Mariner 9 and 10 26, 331
 New Horizons 358, 376
 Odyssey 374
 Pioneer 10 and 11 26, 342, 366
 Ranger 41
 Rosetta 309, 320, 325
 Stardust 308, 318, 320, 325
 Surveyor 41
 Vega 325
 Viking 1 and 2 8, 353
 Voyager 26
Spain 497
Spamer, Earle E. 250, 252, 254, 256
Spärck, R. 182
Sparks, F. W. 388, 407, 423
species, defined 292
speech 9, 60
speed of light 449–450, 454–459, 462
Spencer, John 369–370
Spencer, Jon E. 250, 256
Spengler, Oswald 65
sperm 20
Spetner, Lee M. 79, 466–467
spheres of influence 303–304, 312, 314, 318, 321, 324, 327, 337, 348, 360
Spider Rock 229
spinning bodies 154
spiral galaxies 36, 43
spires 228–229, 247
Spitale, Joseph N. 362
sponges 12
spontaneous generation 5, 51, 75
Spoor, Fred 73
spores 13
Spudis, Paul D. 331
Sputnik I 305, 500
squids, bioluminescence in 25
squirrels, Kaibab and Abert 255
Squyres, Steven W. 373, 596
St. Peter Sandstone 200
Stacey, Frank D. 86, 89, 403, 420–421, 430, 605
Stainforth, R. M. 71
Stair, Ralph 103
stalactites 37, 260, 262–263
stalagmites 37, 260, 262
Stalin, Joseph (1879–1953) 552
Stanley, Steven M. 58, 65, 67, 211
Stansfield, William D. 103, 432, 509
starburst galaxies 445
Stardust spacecraft 308, 318, 320, 325
Starkman, Glenn D. 92
stars 27, 29, 31, 34, 85, 89, 93, 95, 301–302, 456–458, 461, 513–514, 520, 522, 525, 538, 549
B type 32
becoming a black hole 34
beryllium in 32, 93
binaries 34, 95, 97, 458
births 34, 36, 95–96
chemical composition of 457
clusters 106
deaths 36, 94
densities 462
evolution of 34–36
first generation 33
formation of 33–34, 95–97, 104, 304, 440
globular clusters 36, 96, 461–462
in spiral galaxies 43, 446
light 32, 36, 43, 91, 93, 454, 457, 461, 520
low-mass 94
neutron 34
orbiting dust 43
population II 93, 462
population III 32, 93, 462
protostars 95–96
Proxima Centauri 312, 322
redshift 32, 43, 446, 457, 462
stellar evolution 34–36
supernovas 43, 91, 310, 368, 457, 462
velocity 446
white dwarf 34
static friction 204
Staudigel, Hubert 189
Stearley, Ralph F. 531
Steckler, M. S. 256
Steidel, Charles C. 91, 461
Steidl, Paul M. 89, 93, 97, 105–106
Steigerwald, Bill 325
Stein, Seth 190–191
Steinhardt, Paul 454
Steinheim fossil 14
stellar evolution 34–36
stem cells 21
Stephano, Jose Luis 82
Stern, Jack T. Jr. 73
Stern, Robert J. 191
Stern, S. Alan 335, 376
Stern, T. A. 480
sternum 464
Stevens, John K. 55
Stevenson, David J. 85, 89, 375, 609
Stevenson, Peter A. 103–104
Stewart, Glen R. 365
Stewart, John Massey 293–296
stiction (static friction) 193
Stoeckle, Mark 58, 536
Stokes' law 189, 607
Stokstad, Erik 69, 293
Stolte, Daniel 330
Stone, Richard 293, 467
Stonehenge 149
Storch, Natalia I. 450
Storz, Gisela 80
Strahler, Arthur N. (1918–2002) 67, 210, 266, 424, 428, 462, 602
Strait of Gibraltar 140
strange pairs of comets 316–317, 334
strange planets 27, 85
strata 48, 111, 119, 195, 198, 200, 211, 547
Straus, Michael A. 461
Straus, William L. 73
Streptococci 23
stress 125, 185
 concentrations at ends of cracks 125, 146
 involved in earthquakes 161, 185
 stretched ocean ridges 165, 168
Strickberger, Monroe W. 52, 78
strong force 381–383, 393, 419
Strong, James (1822–1894) 523
Strutt, Robert John (1875–1947) 421
Su, Wei-jia 193
subduction 114, 162, 166, 174, 191, 244, 594
submarine
 canyons 48, 111, 116, 136, 138, 169, 182, 196, 241, 256, 488, 516, 547
 volcano 158
subsurface drainage 222, 224–226, 228–229, 234, 236, 239–240, 251, 253
subterranean chamber 111, 125, 130–131, 136, 143, 231, 312, 318, 492–493
pillars in 124, 126, 312, 342, 469–472
subterranean water 124, 131, 135–136, 185, 390–392, 394, 402, 406–407, 414, 488–489, 518, 521, 597–599, 601
Suess, Erwin 142
sugars (right- and left-handed) 18
Sukachev, V. N. 273
sukkah (Hebrew for *canopy*) 522
sulfur 478
Sullivan River 117
Sullivan, Cleo 58
Sullivan, J. W. N. 51
Sumatran earthquake 154
Summa, Lori L. 266
Summit, the world's most powerful supercomputer 57
Sumner, Thomas 141, 192, 480
Sun 27, 31
 angular momentum of 27
 atmosphere 30
 diameter 34
 evolution of 30
 faint when young 31
 orbiting particles 29, 42
 passing comets 42
 radiation 42
Sunderland, Luther D. 63–65, 76–77, 98
Sündermann, J. 579
superclusters 32
supercomputer 55–56
supercritical fluids 477
supercritical water (SCW) 126, 390, 394, 424, 472, 581, 596, 598, 600
superheavy chemical elements 379, 381, 383, 391–392, 406, 408
supernovas 34, 36, 43, 122, 142, 310, 382, 388, 399–400, 408, 411, 413–415, 431, 457, 462
 remnants 43, 105
 superposition 216, 221–222
 super-rotation on Venus 128
Supreme Court of the United States 544, 550, 567–568
surface energy 126, 144
Surveyor spacecraft 41
survival of the fittest 551
Susman, Randall L. 73
Svitil, Kathy A. 463
Svoboda, Elizabeth 330
Swanscombe skull 14
Swedenborg, Emanuel 513
Swedish-British-Norwegian Antarctic Expedition of 1949 499
Swindle, T. D. 86, 328, 431
Swinton, W. E. 67
Sykes, Bryan 100
symbiotic relationships 21, 82



Table of Nations (in Genesis) 499
tables comparing evidence vs. theories
 ocean trenches 165
 Grand Canyon 237

- frozen mammoths 281
 comets 313
 trans-Neptunian objects 364, 448
 radioactivity 401
- tablemounts 138, 158, 165, 169, 516
 Tachibana, Shogo 431
 Tafforeau, Paul 70
 Tagish Lake meteorite 354, 374–375
 Taiwan 517
 talus 216–217, 220, 236–237, 240, 242–245
 Tambora, volcanic eruption in 1815 146
 Tang, Thu 211
 Tanner, William F. 183
 Tanvir, N. R. 95
 Tanzi, Rudolph E. 512
 tar, analogy to rock deep in Earth 40
 Tarr, W. A. 103
 Taubes, Gary 80
 tavek (Hebrew for *within*) 522
 Taylor, B. N. 459
 Taylor, Gordon Rattray (1911–1981) 55, 58, 67, 81
 Taylor, Ian T. 97, 466
 Taylor, Marilyn 266
 Taylor, Perron J. 252
 Taylor, Porcher 47
 Taylor, R. E. 509
 Taylor, Richard L. S. 374
 Taylor, Stuart Ross 105, 585
 tebah (Hebrew for *Ark*) 107
 Tedford, Richard H. 150, 293
 tehom (Hebrew for *surging mass of subterranean water*) 492
 tektite 103
 telescope 462
 Tempel 1, comet 86, 308, 318, 326, 374
 temperature gradient at Earth's surface 118
 Templeton, Alan R. 535
 Tennessen, Jacob A. 512
 Terah (father of Abraham) 484, 505
 Tercaso v. Watkins 544
 Terebey, Susan 514
 Teresi, Dick 78
 termites 19
 Terrance, H. S. 59
 terrarium 475
 Teton Flood 221
 Texas A & M University 418
 Thaler, David 58, 536
 Than, Ker 371
 Tharp, Marie (1920 – 2006) 112
 The American Association for the Advancement of Science 566
 The Book of the Cave of Treasures 525
 The First Book of Adam and Eve 525
 The Great Denudation 216, 236
 The National Research Council 566
 The National Science Teachers Association 566
 The Olgas (in Australia) 207
 The Origin of Earth's Powerful Magnetic Field 180
The Origin of Species 23, 52, 54, 57, 64, 68, 72, 81, 464, 552
 The Origin of Tablemounts 169
 The Secrets of Enoch 525
 the tungsten problem 416
 theistic evolution 537–545
 gap theory 529–531
 thermalize, definition of 426
 thermocapillarity 394
 thermodynamic equilibrium 90
 thermodynamics
 first law 32
 second law 32, 90
 theropod dinosaurs 67
 Thieme, Hartmut 102
- Thillaud, Pierre L. 73
 Thiroulin, Audrey 375
 Thomas, Lewis 76
 Thomas, Michael 53
 Thomas, Peter 368, 370
 Thompson, F. Christian 150
 Thompson, Laird A. 92
 Thompson, Richard L. 99
 Thompson, W. R. 54, 63, 72
 Thomsen, Dietrick E. 95, 463
 Thomson, Keith Stewart 63, 98–99
 thorium 385, 403, 406–407, 422
 Thornhill, Randy 553
 Thorson, Robert M. 269, 293
 thoughts, are they valid? 23, 84
 Thulborn, R. A. 467
 Tibetan Plateau 118, 120, 134, 136, 225, 473, 475, 493
 tidal effects on comets 303, 322
 tidal friction 41
 tidal pumping 126, 345–346, 471, 595, 598, 600
 tidal wave 210
 tides 155, 158, 162, 171, 180, 183, 328, 341–342, 471, 576–580
 Moon vs. Sun 303
 Tiffit, William G. 91, 457, 459
 Tigris, a pre-flood river 475, 478, 535–536
 Tikhonov, Alexei N. 269, 293–294, 298
 Tinkle, William J. (1892–1981) 52
 tipped (or inclined) orbits 27
 Titius, Johann Daniel (1729–1796) 332
 Titius-Bode law 332
 TNO Haumea 375
 Tobie, G. 596
 Tobin, John J. 431
 Todd, Gerald T. 70
 TOKOMAK, a fusion reactor 393
 Tolmachoff, I. P. 273, 293–299
 Tolstoy, Maya 183
 Tomasetti, Christian 512
 Tombaugh, Clyde W. (1906–1997) 28
 Tomoka, Kazushige 342, 367
 Tomirdiario, S. V. 295–296
 Tonga Trench 152
 Toroweap Fault 252
 Toroweap Formation 251
 Tosca, Nicholas J. 333
 Touma, Jihad 580
 toxins 22
 trace fossils 200–201
 Transehe, N. A. 293
 trans-Neptunian objects
 named
 2001 QW₃₂₂ 376
 2012 VP₁₁₃ 359, 363
 Buffy 377
 Sedna 359, 363, 377
 Xena 377
 trans-Neptunian objects (TNOs) 28, 86, 315, 334, 337, 356, 360, 364, 479
 Trans-Siberian Railroad 266
 Travis, John 51, 78, 92, 376–377, 451, 461
 Treash, Robert 88
 tree of life 555
 Trefil, James 91, 97, 106
 Tregelles, Samuel 493
 Tremaine, Scott 85, 87
 trenches, ocean 3, 48, 111, 114, 138, 152–153, 161–192, 547
 ancient trenches 165, 177, 406
 initiation of 165, 177
 undistorted layers in 165, 177
 Trevors, Jack T. 54, 61, 74–75
 trilobites 12, 56, 99
 Trinil, Indonesia 72
 triple junctions 178
 triple point of water 373
 tritium 599
- Trofimov, V. T. 298
 Troitskii, V. S. 455, 459
 Trojan asteroids 349–350, 372
 Trout, Jerry 263
 Trowbridge 377
 Trujillo, Chadwick A. 377
 tsunami 150, 196, 210
 Tukang Besi Ridge 187
 Tully, R. Brent 455
 tundra 267, 278, 280, 296
 Tupi oil field off the Brazilian coast, a vast deposit 396
 turbidity current 196, 210
 Turekian, Karl K. 502
 Turkey 47, 529, 534
 Turkish commissioners (searching for Ark) 46
 Turkmenia 13
 Turner, Edwin L. 451
 Turner, J. L. 96
 Turner, Michael S. 105
 tusks 267, 269–273, 285, 288, 294
 Tuttle, Russell H. 99
 Twenhofel, William Henry (1875–1957) 103
 two creation accounts? 479, 537
 two-celled life, missing 11, 62
- ▲
- U
- U.S. Congress 567
 U.S. Constitution 567
 U.S. Geological Survey 186
 U.S. Library of Congress 497
 U.S. Naval Observatory 455
 U.S. Supreme Court 544, 550, 567–568
 Uchida, Naoki 190
 Udd, Stanley V. 525
 Ukrainitseva, Valentina V. 269, 292–293
 Ultima Thule (UT) 358
 ultimate origins 438, 550
 ultraviolet light 521
 Uluru (see *Ayers Rock*)
 unconformity 39
 unidentified flying objects (UFOs) 533
 uniformitarianism 211, 291–292, 299, 538
 universe 18, 27, 32, 34, 39, 43, 56, 61–62, 79, 84, 90–95, 97, 104, 106, 446, 451–452, 454, 457–462, 526, 532–533, 554
 age of 461–463
 expansion of 33, 439
 unrepeatable events
 dinosaur extinction 123
 unstable galaxies 43
 Urakawa, Satoru 183
 uranium 142, 379–380, 385–386, 389, 392, 401, 403–409, 414, 422, 430, 546
 Uranus 26–27, 29–30, 82, 88, 323, 332, 335
 heat from 42
 moons 346
 ureilites 368
 Urey, Harold (1893–1981) 75, 88
 Ussher, Archbishop James (1581–1656) 483
 Utah 140, 201, 226, 230, 253
 Uzbekistan 13, 495
- ▲
- V
- vacuum 524
 Vail, Isaac Newton (1840–1912) 518, 524, 526, 563
 Valentine, James W. 65
 validity of thought 23, 84
 Vallée, Martin 143
- valley of stability 381–383, 419, 427
 Valley, John W. 87, 475
 Vallois, Henri V. 72
 van Andel, Tjeerd H. 147
 Van de Graaff generator 382
 van de Kamp, Peter 513
 van den Bosch, Remco C. E. 452
 Van der Elst, Philip 85
 van der Lee, Suzan 184
 van Eldik, R. 601
 Van Flandern, Thomas C. 91–92, 332, 365, 368, 455, 459
 Van Gorp, Jan 107
 Van Valen, Leigh 74
 van Woerkom, Adrianus Jan Jasper 315, 328
 Van Wylen, Gordon J. 90
 van Zee, Liese 453
 Vance, Erik 187
 Vangioni-Flam, E. 420, 432
 Vardiman, Larry 97, 421, 525, 563–564, 602
- variations
 among finches 7
 can't produce complexity 6, 53, 58, 83
 enhance survivability 19
 genetic 6
 in cosmic microwave background radiation 92, 460
 limited in living organisms 6, 52
 limited in living things 6
 mutations 53–54
 within kinds 6, 50
- varves 201
 Vasilchuk, Yu K. 298
 Vedder, James F. 87, 335
 Vega spacecraft 325
 vegetation
 reestablished after flood 50, 262
 vegetation (see *plants*)
 Velikovsky, Immanuel (1895–1979) 185
 Venditti, Jeremy G. 252
 Venezuela 13
 Venus 26–27, 31, 40, 88, 90, 105, 128, 350, 412, 456, 519–520
 backward-spinning 27
 craters 40
 hot planet 42
 Maat Mons, a Venus mountain 31
 molten origin 31
 mountains of 31, 90
 no plate tectonics on 26
 super-rotation 128
 super-rotation on 128
 Vereshchagin, Nikolai K. 267, 293–294, 298
 Vermilion Cliffs 216, 222–225, 228, 240, 253
 Verstelle, J. Th. 97
 vertebrates 12, 52, 62, 64, 67, 83
 Vertesszöllos fossil 14
 Vesta, the largest asteroid 366–367
 vestigial organs 11, 62
 Veverka, Joseph 372
 Vidale, John E. 184
 Vidal-Madjar, A. 95, 330, 515
 Viking 1 and 2 spacecraft 353
 Viking spacecraft 8
 Vinogradov, A. P. 293
 Virchow, Rudolf (1821–1902) 71
 viruses 18, 22, 25
 viscosity 103, 173, 188, 190
 Vityaz Trench 152
 viviparous animals 25
 Vogel, Gretchen 80, 88
 Vogelstein, Bert 512
 volcanic
 debris 40, 103
 eruptions 138, 311, 335, 517, 520
 gases 262

volcanism problems 118
volcanoes 87, 118, 142, 146, 152, 155–158, 162, 165–169, 171, 176, 180–181, 188–189, 498
volcanoes and lava 48, 111, 118, 547
Voltaire (François-Marie Arouet) 107
von Braun, Wernher (1912–1977) 56
von Huene, Roland 191
von Schrenck, Leopold 267, 294
von Wrangell, Ferdinand (1796–1870) 296
Voosen, Paul 371, 376
Vosreikov, A. A. 428
Vostok, Antarctic subglacial lake 498–499, 547
Vostrikov, A. A. 602
vowel points 471
Voyager spacecraft 26
Vreeland, Russell H. 101
Vsekhsvyatsky, Sergey Konstantinovich (1905–1984) 88, 321, 327, 332, 335
V-shaped bone 465
Vulgate 522

W

W. H. B. 74
Waddington, Conrad Hal 63
Wadjak, Indonesia 72
Wagner, Andreas 464
Wagner, Kevin 106
Waite, J. H. Jr. 420
Wakefield, J. Richard 389, 423
Wald, George (1906–1997) 51, 54, 75–76, 579
Waldrop, M. Mitchell 89, 92, 97, 105–106, 451–452, 461, 463
Walker, Sara Imari 76
Wallace, Alfred Russel (1823–1913) 52, 85
Walsh, Matthew R. 142
Walt Brown
 proposal for the Grand Canyon 222
Walther, John V. 142
Walton, John C. 81
Wang, Ping 432
Wang, Siyuan 79
Wanpo, Huang 71
Ward, William R. 86
warm-blooded 25
Wartho, J.-A. 184
Washington, H. A. 107
Wasson, J. 431
Watanabe, H. 77
water
 baptism 555
 compressible effects 197
 dissociation of 15, 74–75, 333
 hammer 197, 210, 391–392
 in comets 28, 42, 87, 122, 128, 301–302, 307, 311, 314–315, 318–319, 328, 340
 lens, during liquefaction 198–201, 211
 on Mars 333, 353, 355, 373–374
 origin on Earth 27–28, 42, 86, 328
 planets with 27–28
 properties 27, 87, 116, 173, 197, 278–279, 296–297, 333, 373, 479
 relationship to earthquakes 154, 185
 source for flood v, 48, 87, 109–111, 121

subsurface 118, 124, 133, 135, 209
supercritical 126, 472
triple point 373
vents, from liquefaction 208
water above mountains 48, 485, 489
water lenses 198
water-balloon effect 223, 227, 246
Waters, Frank 517
Watkins, R. S. 466
Watson, C. 596
Watson, David C. C. (1920–2004) 60, 543
Watson, John 70
Watson, Laurie Leshin 372
Watson, Lyall 68
Watson, M. G. 95
Watusi tribe 527
wave-loading 196
Wayman, Erin 150
Weber, Renee C. 104, 331
Weber, Stuart ii
Webster, Christopher 329
Webster, Guy 333
Weed, William Speed 365
Wegener, Alfred (1880–1930) 121, 176
Wei, Wenbo 148
Weidenschilling, Stuart 88
Weinberg, Steven 93, 97, 429, 553
Weinstock, Maia 329
Weintraub, David A. 105
Weisburd, Stefi 141
Weissman, Paul R. 322, 328, 335
Welles, Orson (1915–1985) 353
Wells, H. G. (1866–1946) 353
Wells, Jonathan 62
Welsh, W. F. 515
Welsh, William E. 450, 514
Wendt, Herbert 72, 467
Wenz, John 533
Werblin, Frank 55
Wernet, Philippe 144
West, Stuart A. 59
Wetherill, George W. 87–88, 185, 606, 609
Weygand-Durasevic, Ivana 60
whales 13, 23, 25, 64, 137, 150, 539
What causes earthquakes, and can they be predicted? 163
Wheatley, Henry B. 334
When, Where, How, and Why Did Radioactive Decay Rates Accelerate? 398
Whipple, Fred L. (1906–2004) 85, 96, 105, 315, 327, 334, 431
Whiston, William (1667–1752) 334
Whitby, James 371
Whitcomb, John C. Jr. 212, 449, 524, 563
white blood cell 21
White Cliffs of Dover 259
White Cliffs of Utah 225
white dwarf 34
White, Errol 69
White, Tim 99
Whitmore, John H. 248
Whitney, J. D. 73–74
Why Do We Have Radioactivity on Earth? 122
Why does the Moon have so little dust if it is billions of years old? 583
Wickramasinghe, N. Chandra 57, 79, 95, 326, 329–330, 333, 372, 464, 466–467

wide binaries 358, 364, 376
Widmanstätten patterns 144, 341
Wieczarek, Mark A. 331
Wiegert, Arnold 328
Wiegert, Paul A. 369, 371
Wiener, Norbert (1894–1964) 61
Wilder-Smith, A. E. (1915–1995) 81
Willerslev, Eske 100, 293
Williams, Gareth V. 366, 484
Williams, George C. (1926–2010) 82
Williams, Lindsey 294
Wilson, Edward O. 59
Wilson, J. Tuzo (1908–1993) 190
Wilson, Jack T. 375
Wilson, Knox 495
Wilson, Robert 400
Winchester, A. M. 51, 54
Windhorst, Rogier A. 97
Winters, Jeffrey 335
Wirth, Gregory D. 453
Wisdom, Jack 580
Wise, Kurt P. 424, 563
Wiseman, P. J. 543
wishbone of Archaeopteryx 464
Witmer, Lawrence M. 466–467
Witwatersrand Basin, South Africa 600
Witze, Alexandra 183, 187, 191, 252, 329, 375–377, 452
Witze, alexandra 370
Woehlke, Günther 83
Wolochowicz, Michael 292
wolves 50, 527
Wong, Dale W. 185
Wood, Bernard 71–72
Wood, J. A. 430
Wood, Nathan R. 90
Wood, Richard D. 82
Woodhouse, Mitchell 142
Woodmorappe, John 99, 107, 142, 432
Woodruff, Arthur E. 366
Woodruff, David S. 65
Woodward, A. Smith 99
Woodward, John 107
Woodward, Scott R. 100
Woolfson, Michael 513
words to avoid: creationism, prove 556
working hypotheses 178
worms in Cambrian 12
Wright, G. Frederick 74, 102
Wright, Karen 89
Wright, Larry ii
Wright, Sewall 54
Wu, C. 84
Wuchterl, Günther 515
Wyatt, Stanley P. Jr. 105
Wyoming 201
Wyssession, Michael E. 184

X

xenoliths 157, 254
xenon 29, 87, 184, 353
Xianguang, Hou 69
X-ray resonance spectrograph 465
X-rays 384
Xu, Guochang 596
Xu, Xing 467

Y

Y chromosome 534, 536
Yap Trench 152
Yardley, Bruce W. D. 475
Yarkovsky Effect 362
Yarlung Tsangpo Gorge 413, 432
Yau, Kevin 484
Yeager, Ashley 82
yedoma 275–276, 281–282, 284, 286–292, 295
Yellowstone National park 167
Yeomans, Donald K. 329, 348, 484
Yeskis, Douglas 430
Yeston, Jake 366
Yin, Qingzhu 368
Yitzchaki, Solomon 471, 522
Yockey, Hebert P. 83
yom (Hebrew for a literal day) 538
young comets 42, 104
young craters 40
Young, Davis A. 531
Young, Erick T. 96
Young, Richard A. 250, 252, 254, 256
Young, Susan 191
Yucatán Peninsula 123
yucca moth 21, 56
Yuma, Arizona 233
Yurimoto, Hisayoshi 431

Z

Zabludoff, Marc 421
Zadel, Guido 80
Zag meteorite 371
Zahnle, Kevin J. 373
Zandclean Megaflood 151
Zealandia, a submerged continent 162
Zhang, Jian 184
Zhang, Junjun 89, 331
Zhoa, Depeng 191
Zhou, Zhonghe 467
Zhu, Zhaohuan 87
Zihlman, Adrienne L. 71, 73
Zimmer, Carl 71, 81
Zimmerman, Michael R. 293
zinc ore deposits 600
Zindler, Frank 70
Zion National Park 227, 250
zircons 39, 102, 385, 401, 406–407, 413–414, 421, 424
Zirkle, Conway 553
Zoback, Mark D. 183
zodiacal light 42, 105, 342
Zolensky, Michael E. 371
Zoller, William H. 143
Zook, Herbert A. 583
Zoological Museum, St. Petersburg 266
Z-Pinch 393
Z-pinch 378, 381, 383–384, 393, 413–414, 418
Zuckerman, B. 88
Zuckerman, Solly 71–73
Zwart, Simon F. Portegies 431
Zwicky, Fritz 106